

तमसा मा ज्योतिर्गमय

SANTINIKETAN
VISWA BHARATI
LIBRARY

517.3

Ed 96

v.2

A TREATISE ON THE INTEGRAL CALCULUS
VOLUME II.

A TREATISE
ON THE
INTEGRAL CALCULUS

WITH APPLICATIONS, EXAMPLES
AND PROBLEMS

BY

JOSEPH EDWARDS, M.A.

FORMERLY FELLOW OF SIDNEY SUSSEX COLLEGE, CAMBRIDGE
PRINCIPAL OF QUEEN'S COLLEGE, LONDON

VOLUME II

CHELSEA PUBLISHING COMPANY
NEW YORK, N. Y.

First Edition, Macmillan, 1922

LIBRARY OF CONGRESS CATALOGUE CARD NUMBER 55-234

PRINTED IN THE UNITED STATES OF AMERICA

PREFACE.

THE remarkable progress made in recent years in the Theory of General Functions has revolutionised the method of treatment of many of the higher branches of Pure Mathematics ; and the brilliant work of Riemann, Weierstrass, and their followers has opened out new paths for research. The discovery by Stokes and Seidel of the fundamental principles underlying the convergence of an infinite series has been far-reaching, and the question of uniformity or non-uniformity of approach to a limit which arises in dealing with such series and of continuity in the limiting values of functions dependent upon more than one variable when those variables are made to approach definitely assigned values, are matters which necessitate close attention. Professor Chrystal, in his *Algebra*, vol. ii., discusses such questions at considerable length in a most useful chapter on "The Convergence of Infinite Series and Products."

A general discussion of Abel's Theorem regarding the general integration of Algebraic Functions and of its development by Liouville and others is given by Bertrand (*Calc. Intég.*, ii., ch. v.), and an account of the general problem of integration of a function of a single variable, its possibilities and its barriers, is to be found in No. 2 of the *Cambridge Mathematical Tracts* (2nd ed.) by Mr. G. H. Hardy. A clear and careful exposition of the modern theory of Integration from Riemann's point of view, and of the question of Convergence of Infinite Integrals, is given in Professor Carslaw's work on the *Theory of Fourier's Series*.

It was my original intention to incorporate into this book some account of the more recent developments of the subject, and a long chapter was written for Volume I. with that view. But the further I progressed the stronger was my conviction, gained from many years of experience of work with post-graduate students, that there is in these days far too great a tendency on the part of teachers to push on their pupils so fast to the Higher Branches of Analysis or to Physical Mathematics that many have neither

time nor opportunity for the cultivation of real personal proficiency, or for the acquirement of that individual manipulative skill which is essential to any real confidence of the student in his own power to conduct unaided investigation, and without the possession of which any temporary interest he may have gained as a student must speedily die a natural death. I therefore felt that I should best serve the interests of the majority of readers by endeavouring to help them to cultivate and consolidate their knowledge, and to acquire an adequate mastery over the common processes of the Calculus rather than by pointing out the direction of the more modern trends of thought and by indicating further vistas for research. To do this, it has been necessary to exhibit a large number of worked-out illustrative examples, in addition to furnishing an adequate selection for personal practice. A great part of what I had prepared with regard to modern work was regretfully withdrawn, and other projected and partially completed portions either abandoned or drastically abridged, as they dealt with matters which would rather be of interest to specialists than helpful to the average reader.

The functions considered are for the most part combinations of the Elementary Functions of Ordinary Analysis, continuous and in general bounded, and for such the definition of integration as used by Cauchy and generally adopted in text-books will suffice, and form an adequate instrument for the treatment of the particular classes discussed. The more elaborate definition by Riemann, which furnishes a more powerful and delicate, but at the same time somewhat complex instrument for the discussion of generalised functions, introduces certain difficulties of conception likely to be an unnecessary source of trouble to the ordinary student in his earlier studies. It is therefore postponed until it is to be expected that he has arrived at a thorough mastery of the common processes to be used in the various applications of the Calculus, and has gained a riper experience for its consideration. And it does not appear that any danger is to be apprehended in such delay, seeing that Riemann's definition is specially devised to meet generalities which will only have to be dealt with in a later stage of specialisation.

JOSEPH EDWARDS.

CONTENTS.

CHAPTER XXIII.

CHANGE OF THE VARIABLES IN A MULTIPLE INTEGRAL.

ARTS.		PAGES
826-829.	Change of Order of Integration - - - -	1-13
830-832.	Change of the Variables - - - -	13-27
833-840.	Jacobians. BERTRAND'S Definition and Method of Calculation - - - -	27-33
841-852.	The General Multiple Integral - - - -	33-43
	PROBLEMS - - - -	44-48

CHAPTER XXIV.

EULERIAN INTEGRALS, GAUSS' Π FUNCTION.

853-870.	Beta and Gamma Functions - - - -	49-61
871-874.	$\int_0^{\infty} \frac{x^{n-1}}{1+x} dx$; $\Gamma(n) \Gamma(1-n) = \pi / \sin n\pi$; Gauss' Theorem, a Case - - - -	61-65
875-885.	Theorems of WALLIS and STIRLING - - - -	65-76
886-896.	The Π Function - - - -	76-86
897-909.	EULER'S Constant. GAUSS' Theorem - - - -	87-96
910-930.	Expansions of $\log \Gamma(x+1)$, etc. Calculation of Γ Functions. Definite Integrals - - - -	96-116
931-936.	Approximate Summation - - - -	116-120
937-946.	CAUCHY'S Theorems; Approximation Formulae; DE MORGAN'S Investigation - - - -	121-130
947-954.	Integration by Continued Fractions. Factorial Series for $\psi(a+x)$; GAUSS' Calculation of $\psi(x)$ - -	130-139
955-957.	TABULATED RESULTS - - - -	139-144
	PROBLEMS - - - -	144-152

CHAPTER XXV.

LEJEUNE-DIRICHLET INTEGRALS, LIOUVILLE INTEGRALS.

ARTS.		PAGES
958-967.	DIRICHLET'S Theorem	153-160
968-984.	Extensions by LIOUVILLE, BOOLE, CATALAN. Generalisations	160-173
985-987.	LIOUVILLE'S Integral. LIOUVILLE'S Proof of GAUSS' Theorem	173-175
	PROBLEMS	176-179

CHAPTER XXVI.

DEFINITE INTEGRALS (I.).

988-992.	General Summary of Methods; $\int_0^{\frac{\pi}{2}} \log \sin r \, dr$; Illus- trations	180-188
993-1027.	Form $\int_0^{\infty} \frac{\sin^m rx}{x^n} dx$ ($m \leq n$), etc.	188-207
1028-1030.	WOLSTENHOLME'S Principle	207-208
1031-1034.	$\int_0^{\infty} \frac{\sin^p x}{x^q} dx$ resumed. Partial Fractions	209-213
1035-1041.	$\int_0^{\infty} \frac{e^{-ax} - e^{-bx}}{x} \cos cx \, dx$, $\int_0^{\infty} e^{-x^2} \cos ax \, dx$, $\int_0^{\infty} e^{-x^2} \frac{\sin ar}{x} dx$, etc.	213-216
1042-1070.	Various Forms. $\int_0^{\infty} e^{-c^2(x^2 + \frac{a^2}{x^2})} dx$, $\int_0^{\infty} \frac{\cos rx}{a^2 + r^2} dr$, etc. ; $\int_0^{\infty} \frac{\sin rx \, dr}{x(x^4 + 2a^2r^2 \cos 2a + a^4)}$, $\int_{-\infty}^{\infty} \frac{\cos rx \, dr}{(r-b)^2 + a^2}$, etc. ; $\int_0^{\infty} \frac{\cos rx \, dx}{x^{2n} + a^{2n}}$, $\int_0^{\infty} \frac{\cos rx \, dx}{x^{4n} - 2a^{2n}r^{2n} \cos 2na + a^{2n}}$, etc.	217-236
	PROBLEMS	237-243

CHAPTER XXVII.

DEFINITE INTEGRALS (II.).

LOGARITHMIC AND EXPONENTIAL FUNCTIONS INVOLVED.

1071-1076.	Series required	244-247
1077-1085.	Groups A, B, . . . G. Various Forms of Type	

$$\int \frac{x^q \left(\log \frac{1}{x} \right)^p}{(1 \pm x^r)^s} dx \quad \quad 248-259$$

CONTENTS.

ix

ARTS.	PAGES
1086-1092. General Principles. $\int_0^{\infty} \frac{F(x)}{1+x^n} \frac{dx}{x}$, etc.	260-263
1093-1096. $\int_0^{\frac{\pi}{2}} (\log \sin \theta)^2 d\theta$, etc.	263-265
1097-1098. WOLSTENHOLME'S Expressions for $\int_0^{\infty} \frac{\left(\log \frac{1}{x}\right)^{2r+1}}{1+x^n} dx$	265-266
1099-1100. Group H. LEGENDRE'S Rule. KUMMER'S Integrals	266-269
1101-1103. Groups I, J. Derivations from $\int_0^{\infty} \frac{x^{a-1}}{1+x} dx$ ($1 > a > 0$)	269-274
1104-1107. Group K. Type $\int_0^{\infty} \frac{\cosh px}{\sinh qx} \sin mx dx$	274-278
1108-1120. Groups L, M, N. Formulae of POISSON, ABEL, CAUCHY, LEGENDRE	278-286
PROBLEMS	287-292

CHAPTER XXVIII.

DEFINITE INTEGRALS (III.).

1121-1133. Types $\int_0^{\pi} \cos^p x \cos qx dx$, etc. ; $\int_0^{\pi} x^p \sin^{2n} x dx$, etc.	293-301
1134-1158. Results derivable from well-known Series. Type $\int_0^{\pi} \frac{\cos p\theta}{(1-2a \cos \theta + a^2)^n} d\theta$	301-320
1159-1168. SERRET'S Investigation of $\int_0^{\infty} e^{-kx} x^{n-1} dx$, k complex. Deductions	321-327
1169-1181. FRESNEL'S Integrals. SOLDNER'S Function $\text{li}(x)$	327-336
1182-1188. FRULLANI'S Theorem. ELLIOTT'S and LEUDESORF'S Extensions	337-342
1189-1201. Complex Constants	342-352
PROBLEMS	353-361

CHAPTER XXIX.

THE COMPLEX VARIABLE. VECTORS. CONFORMAL
REPRESENTATION.

1202-1221. Vectors. Laws of Combination. ARGAND Diagram. DEMOIVRE'S Theorem	362-376
1222-1234. Continuity, etc. Revision of Definitions	376-382

ARTS.	PAGES
1235-1242. Conformal Representation. WEIERSTRASS' Example of a Function with no determinable Differential Coefficient. Differentiation of a Complex Function - - - - -	382-387
1243-1246. Definitions. Zeros, Singularities, etc. - - -	388-389
1247-1255. Conformal Representation. Isogonal Property, Connection of Elements of Area. Connection of Curvatures. Curvature Formulae. Quasi-Inversion. Homographic Relation - - - -	389-402
1256-1262. Branch Points. RIEMANN'S Surfaces - - -	402-406
1263-1265. Number of Roots in a given Contour - - -	407-415
PROBLEMS - - - - -	415-418

CHAPTER XXX.

INTEGRATION. CONTOUR INTEGRATION. TAYLOR'S THEOREM.

1266-1274. Definitions. General Properties. Integration of a Series - - - - -	419-423
1275-1285. CAUCHY'S Theorem. Deformation of a Path. Loops. Exclusion of Singularities - - - -	423-434
1286-1287. $\int \frac{\phi(z) dz}{z-a}$, $\int \frac{\phi(z) dz}{(z-a_1)(z-a_2)\dots(z-a_r)}$ - - -	434-436
1288-1297. Branch-Points and their Effect - - - -	436-446
1298. Period-Parallelograms - - - - -	446-447
1299-1300. Differential Coefficients of a Synectic Function. TAYLOR'S Theorem - - - - -	448-452
1301-1328. Contour Integration - - - - -	452-478
PROBLEMS - - - - -	479-482

CHAPTER XXXI.

ELLIPTIC INTEGRALS AND FUNCTIONS.

1329-1342. Periodicity - - - - -	483-498
1343. $\operatorname{sn} u$, $\operatorname{cn} u$, $\operatorname{dn} u$ - - - - -	498
1344-1354. Addition Formulae and Deductions. JACOBI'S 33 Formulae. Periodicity - - - - -	498-508
1355-1361. Duplication, Dimidiation, Triplication - - -	508-511
1362-1365. The General Proposition for Addition Formulae. Second and Third Classes of Legendrian Integrals	511-513

CONTENTS.

xi

ARTS.	PAGES
1366-1379. Jacobian Zeta, Eta, Theta Functions. Integrations involving Jacobian Functions - - - -	514-519
PROBLEMS - - - - -	520-529

CHAPTER XXXII.

ELLIPTIC INTEGRALS. THE WEIERSTRASSIAN FORMS.

1380-1384. Definitions of $\wp(u)$, $\zeta(u)$, $\sigma(u)$. The Differential Coefficients of $\wp(u)$ - - - - -	530-532
1385-1386. Periodicity of $\wp(u)$ - - - - -	532-534
1387-1413. Addition Formula for $\wp(u)$. Deductions. $\wp(nu) - \wp(u)$. SCHWARZ - - - - -	534-545
1414-1415. Connection of the Weierstrassian and Legendrian Periods and Functions - - - - -	545-547
1416-1419. Expansions of the Weierstrassian Functions - - - - -	547-549
1420-1431. Addition Formulae for Zeta and Sigma Functions and Deductions - - - - -	549-553
1432-1445. Differentiation of $\wp(u)$ and Integration by Aid of Weierstrassian Functions - - - - -	553-560
PROBLEMS - - - - -	561-566

CHAPTER XXXIII.

ELLIPTIC FUNCTIONS. REDUCTION TO STANDARD FORMS.

1446-1458. Reduction to Weierstrassian Form - - - - -	567-578
1459-1479. Reduction to Legendrian Form - - - - -	578-593
1480-1481. LANDEN'S Transformation. Illustrative Examples - - - - -	594-597
PROBLEMS - - - - -	598-603

CHAPTER XXXIV. (SECTION I.)

CALCULUS OF VARIATIONS.

1482-1498. The Symbols δ , ω . Notation. Variation of an Integral - - - - -	604-614
1499-1502. Conditions for a Stationary Value. The Equation $K=0$ - - - - -	614-620
1503. Case of V dependent on Terminals - - - - -	621
1504-1507. Relative Maxima and Minima. LAGRANGE'S Rule. V a Perfect Differential - - - - -	621-629

ARTS	PAGES
1508-1523. Several Dependent Variables	629-639
1524-1546. Geodesics, Least Action, Brachistochronism, Energy Condition of Equilibrium	639-650
PROBLEMS	650-660

CHAPTER XXXIV. (SECTION II.)

DOUBLE INTEGRALS. CULVERWELL'S METHOD OF
DISCRIMINATION.

1547-1557. Double Integrals. Two Independent Variables	661-669
1558-1564. Relative Maxima and Minima. Bubbles. Limited Variation	669-673
1565. Stationary Value of $\iint U dS$, with condition $\iint W dx dy = a$	673-674
1566-1583. Discrimination. CULVERWELL'S Method. Conjugate Points. Various Cases	674-691
1584. BIBLIOGRAPHY	691
PROBLEMS	692

CHAPTER XXXV. (SECTION I.)

FORMULAE OF LAGRANGE AND FOURIER.

1585-1596. FOURIER'S Theorem. The Cosine Series. The Sine Series	693-699
1597-1604. A Remarkable Limiting Form. POISSON'S Investiga- tion	699-710
1605-1608. GRAPHICAL REPRESENTATION OF THE RESULTS	710-712
1609-1615. REMARKS AND ILLUSTRATIONS	712-716
PROBLEMS	717-719

CHAPTER XXXV. (SECTION II.)

DIRICHLET'S INVESTIGATION.

1616-1625. DIRICHLET'S Investigation. Existence of Maxima and Minima, Discontinuities	720-728
1626-1627. Application to FOURIER'S Series. CAUCHY'S Identity	729-730
1628-1632. The Limit $Lt_{\omega \rightarrow \infty} \int_0^h \frac{\sin \omega r}{r} \phi(r) dr$. Graphical Illustrations	731-734
1633-1639. Various Deductions. FOURIER'S Formula	734-736
PROBLEMS	737-744

CHAPTER XXXVI.

MEAN VALUES.

ARTS.	PAGES
1640-1650. General Conception. Combination of Means. Density of a Distribution - - - - -	745-754
1651-1654. The Inverse Distance. Theorems on Potential. Typical Examples - - - - -	754-757
1655-1656. A Useful Artifice - - - - -	757-766
1657-1663. $M(\rho^2)$, $M(\rho^n)$. Mean Areas and Volumes. Miscellaneous Means - - - - -	766-778
1664-1670. Certain Inequalities, and their Consequences. General Means in Terms of Restricted Means - -	779-782
1671-1679. CLERK MAXWELL'S "Geometric Mean," useful for Electromagnetic Problems - - - -	782-786
PROBLEMS - - - - -	786-791

CHAPTER XXXVII.

CHANCE.

1680-1687. Definitions and Illustrations of Applications of the Calculus - - - - -	792-800
1688-1691. Random Points - - - - -	800-802
1692-1695. Condensation Graph. Illustrations - - - -	802-819
1696-1703. Inverse Probability. BAYES' Problem - - -	820-825
1704-1706. BUFFON'S Problem. Parallel Rulings. Rectangular Rulings - - - - -	825-827
1707-1711. Random Lines - - - - -	828-830
1712-1722. Number of Lines crossing a Contour. Various Cases	830-834
1723-1735. Theorems of SYLVESTER and CROFTON - - -	834-844
1736-1743. D'ALEMBERT'S Mortality Curve. Definitions. Expectation of Life - - - - -	844-848
PROBLEMS - - - - -	849-852

CHAPTER XXXVIII.

UNCERTAINTIES OF OBSERVATION.

1744-1749. LAPLACE'S Hypothesis. Frequency Law. Weight. Modulus - - - - -	853-857
1750. Mean Error. Mean of Squares. Error of Mean Square. Probable Error - - - - -	857-858

ARTS.	PAGES
1751-1752. KRAMP'S Table. The Graph	858-859
1753-1756. Resultant Weight. Weight of a Series of Observations	859-862
1757-1758. Determination of Error of Mean Square from "Apparent Errors"	862-863
1759-1762. Reduction to Linear Form of Equations connecting Errors of a System of Physical Elements. Standardisation	863-865
1763. PRINCIPLE OF LEAST SQUARES	865
1764-1779. The Normal Equations. Order of Procedure. BIBLIOGRAPHY. ILLUSTRATIONS	866-875
PROBLEMS	876-878

(CHAPTER XXXIX.

THEOREMS OF STOKES AND GREEN. HARMONIC ANALYSIS.

1780-1781. STOKES' Theorem	879-881
1782-1784. GREEN'S Theorem. Deductions	882-886
1785-1797. Harmonic Analysis. Spherical, Solid and Surface Harmonics. Poles and Axes	886-890
1798-1808. LEGENDRE'S Coefficients. Zonal Harmonics. Properties. Power Series. RODRIGUES' Form. Various Expressions for $P(p)$	890-894
1809-1812. Limiting Values. Expressions in terms of Definite Integrals	894-895
1813-1814. Various Forms of LAPLACE'S Equation	895-897
1815-1816. The Differential Equation satisfied by a LEGENDRE'S Coefficient. General Solution	897-898
1817-1826. $\int_{-1}^1 P_m P_n dp = 0, m \neq n.$ P_n in terms of $p.$ Deductions	898-902
1827. $\int_{-1}^1 P_n^2 dp = \frac{2}{2n+1}$	902
1828-1831. $\int_{-1}^1 \frac{P_n}{R^m} dp.$ Calculation of the Coefficient of P_n in p^n	902-905
1832-1833. Expansion of $f(p)$ in terms of LEGENDRE'S Coefficients. Series Unique	905
1834-1835. $P_n', P_n'',$ etc., in terms of LEGENDRE'S Coefficients	905-906
1836-1837. $\int_{-1}^1 P_m' P_n' dp$	906-907
1838-1849. IVORY'S Equation. Various Working Theorems	907-911

CONTENTS.

XV

ARTS.	PAGES
1850-1852. Illustrative Applications	911-912
1853. LIST OF WORKING FORMULAE.	913
1854-1856. Roots of $P_n = 0$. Graphs of $r = aP_n$, $r = a(1 + \epsilon P_n)$	914-917
1857-1860. $\Sigma(2n+1)P_n$. A Discontinuity. Physical Meaning	917-920
1861-1863. Practical Expression of a Rational Function in Solid Harmonics	920-921
1864. Change of Axis	921-923
1865-1867. Tesseral and Sectorial Harmonics	923-925
1868-1869. Expansion of $F(\mu, \phi)$. O'BRIEN'S PROOF	925-927
1870-1871. Integral of Product of two Harmonics over Unit Sphere	927-928
1872. Theorem as to V within or without the Sphere when known on the Surface	928
1873-1874. Differentiation of Zonal Harmonics. Change of Origin	929-930
PROBLEMS	931-939

CHAPTER XL.

SUPPLEMENTARY NOTES.

1875-1883 A. RIEMANN'S Definition and Theorem	940-945
1884-1889 B. Convergence of an Infinite Integral	945-948
1890 C. Strict Accuracy of Standard Forms	948-949
1891-1893 D. HERMITE'S Method for Rational Fractions	949-952
1894 E. LEGENDRE'S Transformation applied to Form $\int \frac{dx}{X\sqrt{Y}}$	952-953
1895-1899 F. Continuity of a Function of two Independent Variables. Differentiation of a Definite Integral. Double Integrals	953-956
1900-1902 G. Uniform Convergence. Double Limits	956-957
1903-1904 H. Unicursal Curves	957-959
1905-1910 I. GENERAL REVIEW	959-962
PROBLEMS	962-966
ANSWERS	966-974
INDEX	975-980

CHAPTER XXIII.

CHANGE OF THE VARIABLES IN A MULTIPLE INTEGRAL.

826. A NUMBER of cases have occurred in previous chapters in which the evaluation of an area or a volume has been much facilitated by a proper choice of coordinates, and changes have been made from one specific system of coordinates to another specific system, such, for example, as from Cartesians to polars, or to elliptic coordinates.

In particular, we have established the results, that in transforming from an x, y system, which may be regarded as Cartesian, to a u, v system, we have

$$\iint V \, dx \, dy = \iint V' \frac{\partial(x, y)}{\partial(u, v)} \, du \, dv;$$

and when we change from a three-dimensional Cartesian x, y, z system to another system in terms of new variables u, v, w , we have

$$\iiint V \, dx \, dy \, dz = \iiint V' \frac{\partial(x, y, z)}{\partial(u, v, w)} \, du \, dv \, dw,$$

the symbol V' representing merely the value of V as expressed in terms of the new coordinate system.

These changes have been found very especially useful in the case where the *bounding curves or surfaces of the regions under consideration are themselves members of the three families,*

$$u = \text{const.}, \quad v = \text{const.}, \quad w = \text{const.}$$

This was the case in the typical example of Art. 793, viz. the evaluation of the area of a Carnot's cycle, bounded by isothermals $xy = \alpha_1$, $xy = \alpha_2$, and the adiabatics $xy^\gamma = \beta_1$, $xy^\gamma = \beta_2$; and it will be recalled that

the region thus bounded was divided into elementary areas bounded by curves of the same types, viz.

$$\begin{aligned} xy &= u, & xy' &= v, \\ xy &= u + \delta u, & xy' &= v + \delta v. \end{aligned}$$

Exactly the same course was followed in the three-dimension typical examples of Articles 797, 798.

827. Further Examples.

1. The quadrilateral bounded by the four parabolas

$$y^2 = a^2x, \quad y^2 = b^2x, \quad x^2 = e^2y, \quad x^2 = f^2y,$$

revolves round the axis of y ; find the volume generated.

[COLLEGES a, 1890.]

If $\delta x \delta y$ be an elementary rectangle of this area, we have

$$V = \iint 2\pi x \, dx \, dy$$

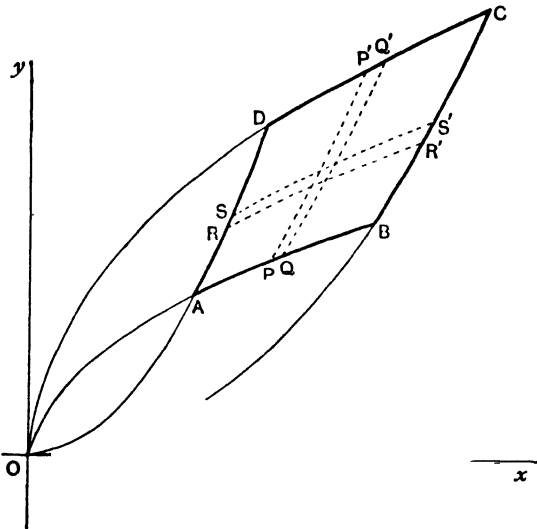

Fig. 295.

Now, instead of taking elements of rectangular shape such as $\delta x \delta y$, let us divide up the area by the families of parabolas

$$y^2 = u^2x, \quad x^2 = v^2y, \dots\dots\dots(1)$$

Then $u = a$ and $u = b$, $v = e$ and $v = f$ are the bounding parabolas of the region, and the elementary area enclosed by $u, u + \delta u, v, v + \delta v$ is $+ J \delta u \delta v$.

From equations (1) $x = uv^2$, $y = u^2v$,

$$J \equiv \frac{\partial(x, y)}{\partial(u, v)} = \begin{vmatrix} v^2 & 2uv \\ 2uv & u^2 \end{vmatrix} = -3u^2v^2.$$

Hence

$$\begin{aligned} V &= 6\pi \int_a^b \int_a^f u^2 v^4 du dv \\ &= \frac{6\pi}{4 \cdot 5} \left[u^4 \right]_a^b \left[v^5 \right]_f \\ &= \frac{3\pi}{10} (a^4 - b^4)(e^5 - f^5). \end{aligned}$$

2. Evaluate the triple integral $\iiint \frac{dx dy dz}{xyz}$ taken through a volume bounded by six confocal quadrics, the semiaxes of the quadrics being

$$\begin{array}{ccc} (a_1, b_1, c_1), & (a_2, b_2, c_2), & (a_3, b_3, c_3), \\ \text{and } (a'_1, b'_1, c'_1), & \text{and } (a'_2, b'_2, c'_2), & \text{and } (a'_3, b'_3, c'_3). \end{array}$$

[MATH. TRIP., 1889.]

Taking a definite confocal a, b, c , let the three confocals through any point x, y, z of the region be

$$\frac{x^2}{a^2 + \lambda} + \frac{y^2}{\lambda} + \frac{z^2}{\lambda} = 1, \quad \frac{x^2}{a^2 + \mu} + \frac{y^2}{\mu} + \frac{z^2}{\mu} = 1, \quad \frac{x^2}{a^2 + \nu} + \frac{y^2}{\nu} + \frac{z^2}{\nu} = 1,$$

and we have $x^2 = \frac{(\lambda + a^2)(\mu + a^2)(\nu + a^2)}{(a^2 - b^2)(a^2 - c^2)}$, etc. (Art. 812);

whence $\frac{\partial x}{\partial \lambda} = \frac{1}{\lambda + a^2}$, $\frac{\partial x}{\partial \mu} = \frac{1}{\mu + a^2}$, etc.,

and
$$J \equiv \frac{\partial(x, y, z)}{\partial(\lambda, \mu, \nu)} = \frac{xyz}{8} \begin{vmatrix} \frac{1}{\lambda + a^2} & \frac{1}{\mu + a^2} & \frac{1}{\nu + a^2} \\ \frac{1}{\lambda + b^2} & \frac{1}{\mu + b^2} & \frac{1}{\nu + b^2} \\ \frac{1}{\lambda + c^2} & \frac{1}{\mu + c^2} & \frac{1}{\nu + c^2} \end{vmatrix}$$

Hence

$$\begin{aligned} \iiint \frac{dx dy dz}{xyz} &= \frac{1}{8} \iiint \Sigma \left(\frac{1}{\lambda + a^2} \cdot \frac{1}{\mu + b^2} \cdot \frac{1}{\nu + c^2} - \frac{1}{\mu + c^2} \cdot \frac{1}{\nu + b^2} \right) d\lambda d\mu d\nu \\ &\quad - \frac{1}{8} \Sigma [\log(\lambda + a^2)] \{ [\log(\mu + b^2)] [\log(\nu + c^2)] \\ &\quad \quad - [\log(\mu + c^2)] [\log(\nu + b^2)] \}, \end{aligned}$$

and at one set of the boundaries

$$\begin{aligned} \lambda + a^2 &= a_1^2, & \lambda + b^2 &= b_1^2, & \lambda + c^2 &= c_1^2, \\ \mu + a^2 &= a_2^2, & \mu + b^2 &= b_2^2, & \mu + c^2 &= c_2^2, \\ \nu + a^2 &= a_3^2, & \nu + b^2 &= b_3^2, & \nu + c^2 &= c_3^2; \end{aligned}$$

and for the other set,

$$\lambda + a^2 = a_1'^2, \quad \lambda + b^2 = b_1'^2, \quad \text{etc.}$$

Hence the limits for λ are from $a_1^2 - a^2$ to $a_1'^2 - a^2$,

for μ from $b_1^2 - b^2$ to $b_1'^2 - b^2$,

for ν from $c_1^2 - c^2$ to $c_1'^2 - c^2$.

Therefore

$$\iiint \frac{dx dy dz}{xyz} = \frac{1}{8} \Sigma \log \frac{a_1'^2}{a_1'^2} \left(\log \frac{b_1'^2}{b_1'^2} \log \frac{c_1'^2}{c_1'^2} - \log \frac{b_2'^2}{b_2'^2} \log \frac{c_2'^2}{c_2'^2} \right)$$

$$= \begin{vmatrix} \log \frac{a_1'}{a_1'}, & \log \frac{b_1'}{b_1'}, & \log \frac{c_1'}{c_1'} \\ \log \frac{a_2'}{a_2'}, & \log \frac{b_2'}{b_2'}, & \log \frac{c_2'}{c_2'} \\ \log \frac{a_3'}{a_3'}, & \log \frac{b_3'}{b_3'}, & \log \frac{c_3'}{c_3'} \end{vmatrix}$$

828. Remarks on the Transformation.

The usefulness of a change of variables is not, however, confined to the case in which the bounding curves or surfaces of the region considered *are particular cases of the families of curves or surfaces by which it has been deemed desirable to divide up the region* into elements and for which case the limits *are constants*.

The process of transformation is threefold :

(a) The transformation of the subject of integration into terms of the new variables.

(b) The determination of the new element of integration, which resolves itself into the calculation of J .

(c) The determination of the new limits.

Of these, (a) and (b) are merely algebraic processes, and give no trouble.

The determination of the new limits (c) however, often presents considerable difficulty to the student. And we cannot lay down explicit rules to be followed to suit all cases. Generally speaking, it is best to proceed, from geometrical considerations, first *forming a clear idea of the region which the original element of area or volume was made to traverse*. This will be clearly indicated by the limits of the integrals occurring in the expression to be transformed. Then the new limits for the transformed integral must be so chosen that the new *element of area or volume, as the case may be, traverses the same region, once and once only*, as was traversed by the original element in its march as defined by the limits of the original integral.

The student will require considerable practice in the assignment of the new limits, and therefore a number of illustrative

examples are appended from which he may gather an idea of the course to be adopted.

And before proceeding to discuss them in detail the student is advised to note that at times, even a *change of order in the integration*, without any change in the variables, may be useful, and that in some cases an integration in different orders may lead to important conclusions. Some of the earlier examples are therefore confined to mere change of order with no change in the coordinates, and the necessary change in the limits will be the subject of main attention.

829. CHANGE OF ORDER OF INTEGRATION.

Ex. 1. Consider $\int_a^b dx \int_c^d dy f(x, y)$, all the limits being known constants.

Here the space bounded by $y=c$, $y=d$, $x=a$, $x=b$ is the region through which all products such as $f(x, y) \delta x \delta y$ are to be added, viz. the

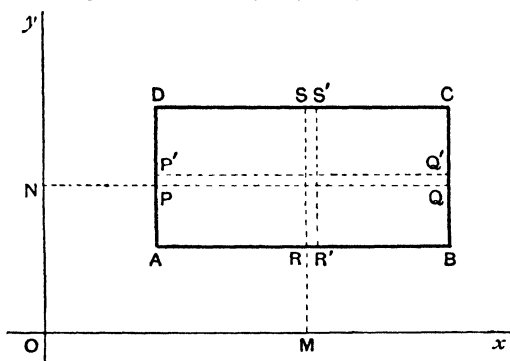

Fig. 296.

rectangle $ABCD$ in Fig. 296. In the integration as it stands we integrate first with regard to y , keeping x constant, thus adding up all elements in such a strip as $RSS'R'$ in the figure. Then all such strips are to be added in the operation $\int_a^b () dx$.

If we wish to change the order of the operation and express it as

$$\int dy \int dx f(x, y)$$

we have to assign the new limits.

Clearly in this case the sum of such elements as we have considered, added up along such a strip as $PQ'P'$ parallel to the x -axis, will be

$$\int_a^b f(x, y) dx,$$

and the sum of all these strips, from $y=c$ to $y=d$, will be

$$\int_c^d dy \int_a^b dx f(x, y).$$

Thus
$$\int_a^b dx \int_c^d dy f(x, y) = \int_c^d dy \int_a^b dx f(x, y).$$

It appears therefore that in the case of constant limits no change is entailed by a change in the order of integration.

Ex. 2. Consider $\int_0^a \int_0^x f(x, y) dx dy$.

Here the limits for y are from $y=0$ to $y=x$, and for x from $x=0$ to $x=a$.

These indicate that the boundaries of the region for which the elements $f(x, y) \delta x \delta y$ are to be added are

the x -axis, the line $y=x$, the line $x=a$.

And if instead of taking strips parallel to the y -axis, we add up the elements in strips parallel to the x -axis, of which $PQ'Q'I'$ is a type

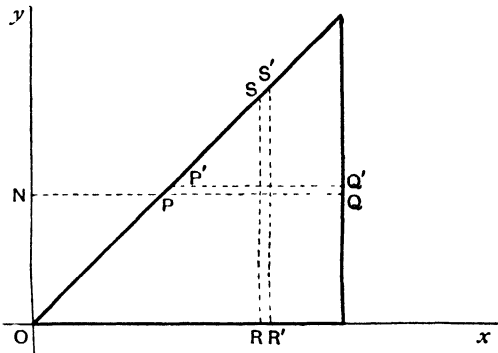

Fig. 297

(Fig. 297), this summation is to be taken from $x=y$ to $x=a$, and $\int_y^a f(x, y) dx$ will be the sum for the strip $PQ'Q'I'$.

These strips are then to be added from $y=0$ to $y=a$, giving

$$\int_0^a \int_y^a f(x, y) dy dx$$

as the transformed result.

Ex. 3. Consider $\int_0^{a \cos \alpha} \int_{x \tan \alpha}^{\sqrt{a^2 - x^2}} f(x, y) dx dy$.

The region of integration is bounded by the straight line $y=x \tan \alpha$, the circle $y=\sqrt{a^2 - x^2}$, and the y -axis.

The present summation is that of strips parallel to the y -axis. If we change the order of the integration we must add up all elements in a strip parallel to the x -axis before adding the strips.

These strips change their character at the point where $y = a \sin \alpha$; from $y = 0$ to $y = a \sin \alpha$, the length of a strip is bounded by the y -axis and the straight line $y = x \tan \alpha$; from $y = a \sin \alpha$ to $y = a$ the strip is terminated by the circle.

Hence the integration consists of two separate parts, viz.

$$\int_0^{a \sin \alpha} \int_0^{y \cot \alpha} f(x, y) dy dx + \int_{a \sin \alpha}^a \int_0^{\sqrt{a^2 - y^2}} f(x, y) dy dx.$$

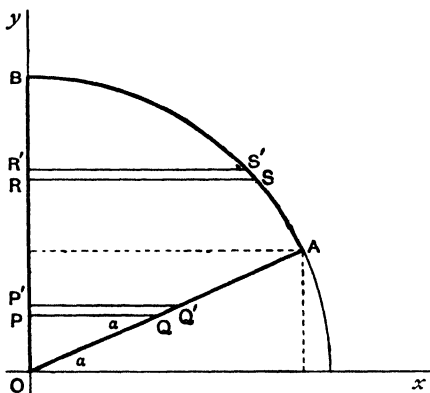

Fig. 298.

It is often useful to test general results and verify our conclusions by application to some simple case. Take, for instance, $f(x, y) = 1$. Then the primary integral represents the area of the sector of a circle of radius a and angle $\frac{\pi}{2} - \alpha$. Hence the result should be $\frac{1}{2} a^2 \left(\frac{\pi}{2} - \alpha \right)$.

The integration of the transformed result is

$$\begin{aligned} & \int_0^{a \sin \alpha} y \cot \alpha dy + \int_{a \sin \alpha}^a \sqrt{a^2 - y^2} dy \\ &= \left[\frac{y^2}{2} \cot \alpha \right]_0^{a \sin \alpha} + \frac{1}{2} \left[y \sqrt{a^2 - y^2} + a^2 \sin^{-1} \frac{y}{a} \right]_{a \sin \alpha}^a \\ &= \frac{a^2}{2} \sin \alpha \cos \alpha + \frac{1}{2} a^2 \cdot \frac{\pi}{2} - \frac{1}{2} a^2 \sin \alpha \cos \alpha - \frac{a^2}{2} \alpha = \frac{a^2}{2} \left(\frac{\pi}{2} - \alpha \right), \end{aligned}$$

as it should be.

Ex. 4. To change the order of integration in the integral

$$\int_0^a \int_{\sqrt{ax-x^2}}^{\sqrt{ax}} f(x, y) dx dy.$$

Here the region of integration is bounded by

- (1) The parabola $y^2 = ax$.
- (2) The semicircle $x^2 + y^2 = ax$, which we may note is the circle of curvature at the vertex of the parabola, and lies entirely within the parabola.

(3) The straight line $x=a$; and this is a tangent to the circle.

Instead of adding up the quantities $f(x, y) \delta x \delta y$ along strips such as DE (Fig. 299) parallel to the y -axis, and then adding the strips, we have

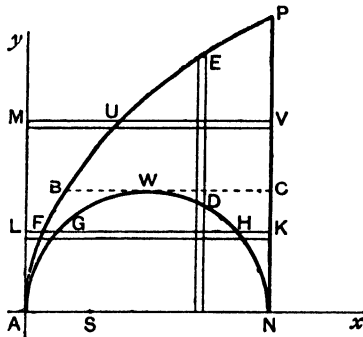

Fig. 299.

to add up elements in a strip parallel to the x -axis, and then add up these new strips. It will be noted that so long as y is less than $\frac{a}{2}$ such strips are broken into two parts as FG and HK , but for values of $y > \frac{a}{2}$ they are continuous as at UV . Let W be the point of contact of the tangent BC to the semicircle, which is parallel to the x -axis. The new integration must cover the three portions

(1) $AFBWGA$; (2) $WCKNHW$; (3) $BUPCWB$.

Referring to the figure in which the lines FK and UV parallel to the x -axis meet the y -axis at L and M respectively,

In region (1),

the limits for x are from LF to LG , and for y from 0 to NC .

In region (2),

the limits for x are from LH to LK , and for y from 0 to NC .

In region (3),

the limits for x are from MU to MV , and for y from NC to NP .

Hence the transformed result will be

$$\int_0^{\frac{a}{2}} \int_{\frac{y^2}{a}}^{\frac{a}{2} - \sqrt{\frac{a^2}{4} - y^2}} f(x, y) dy dx + \int_0^{\frac{a}{2}} \int_{\frac{a}{2} + \sqrt{\frac{a^2}{4} - y^2}}^a f(x, y) dy dx + \int_{\frac{a}{2}}^a \int_{\frac{y^2}{a}}^a f(x, y) dy dx.$$

Ex. 5. Change the order of integration in

$$\int_0^{\frac{\pi}{2}} \int_{a \cos \theta}^{a(1 + \cos \theta)} f(r, \theta) r d\theta dr + \int_{\frac{\pi}{2}}^{\pi} \int_0^{a(1 + \cos \theta)} f(r, \theta) r d\theta dr.$$

As the integral stands, integration is effected through a region bounded by the upper half cardioid $r = a(1 + \cos \theta)$, the upper half circle $r = a \cos \theta$ and the intercepted portion of the initial line.

When the order of integration is changed we are to add elements along strips which are bounded by circular arcs as shown in Fig. 300, and then add all the strips. Let BC be the arc, with centre O , which touches the circle at B . Let $MQ, M'Q'$ be contiguous arcs with centres at O intercepted between the circle and the cardioid, and $NP, N'P'$ contiguous

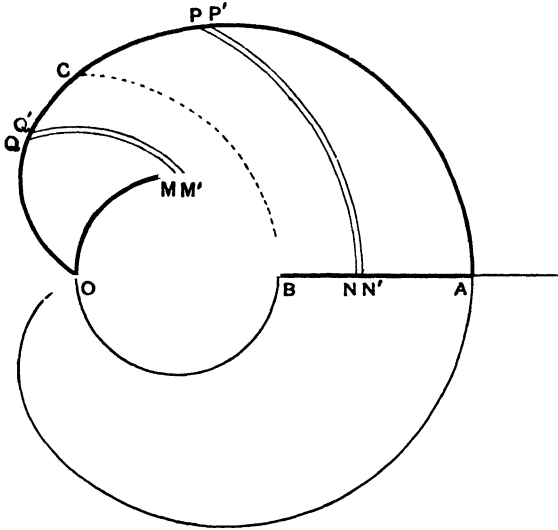

Fig. 300.

arcs with centres at O intercepted between the initial line and the cardioid. Then the new limits of integration are :

for θ , from $\theta = A\hat{O}M$ to $\theta = A\hat{O}P$, for values of r from O to OB ,
and for θ , from $\theta = 0$ to $\theta = A\hat{O}P$, for values of r from OB to OA .

The first of these accounts for the region $OMBCQO$.

The second accounts for the region $APCBA$.

And the transformed integral stands as

$$\int_0^a \int_{\cos^{-1}\frac{r}{a}}^{\cos^{-1}\frac{r-a}{a}} f(r, \theta) r dr d\theta + \int_a^{2a} \int_0^{\cos^{-1}\frac{r-a}{a}} f(r, \theta) r dr d\theta.$$

Ex. 6. Change the order of operation in the integration system

$$\int_0^a \int_{\frac{x}{2a}(2a-x)}^{\sqrt{2ax-x^2}} f(x, y) dx dy + \int_a^{9a} \int_{\frac{x}{2a}(2a-x)}^{\frac{2ax}{5x-3a}} f(x, y) dx dy$$

$$\int_{\frac{9a}{5}}^{2a} \int_{\frac{x}{9a}(2a-x)}^{\sqrt{2ax-x^2}} f(x, y) dx dy.$$

Here summation is effected by strips parallel to the y -axis within a region bounded by

(1) the parabola $2ay = x(2a - x)$,

(2) the semicircle $y^2 = 2ax - x^2$,

(3) the hyperbola $5xy = 2ax + 3ay$.

The coordinates of the intersections of the curves are shown in Fig. 301.

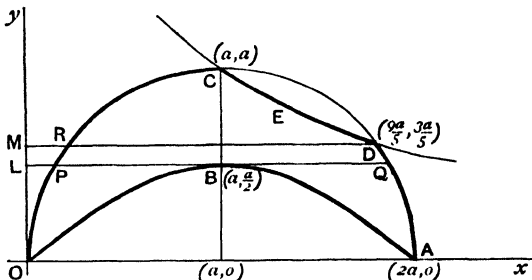

Fig. 301.

Let C, D be the intersections of the circle and the hyperbola, and B the vertex of the parabola. Let LPQ be the tangent to the parabola at B , and let MD be drawn through D parallel to the x -axis, cutting the y -axis at L and M respectively.

Then in division by strips parallel to the x -axis we have four regions to consider, viz. : (i) OPB , (ii) BQ_1 , (iii) $PRDQ$, and (iv) $RCEDR$.

We then obtain for the transformed result,

$$\int_0^{\frac{a}{2}} \int_{a-\sqrt{a^2-2ay}}^{a-\sqrt{a^2-y^2}} f(x, y) dy dx + \int_0^{\frac{a}{2}} \int_{a+\sqrt{a^2-y^2}}^{a+\sqrt{a^2-2ay}} f(x, y) dy dx$$

$$+ \int_{\frac{a}{2}}^{\frac{3a}{5}} \int_{a-\sqrt{a^2-y^2}}^{a+\sqrt{a^2-y^2}} f(x, y) dy dx + \int_{\frac{3a}{5}}^a \int_{a-\sqrt{a^2-y^2}}^{3ay-2a} f(x, y) dy dx,$$

the several items of integration referring to the respective regions enumerated.

Ex. 7. Evaluate the integral $\int_0^{\infty} \int_x^{\infty} \frac{e^{-y}}{y} dx dy$. [ST. JOHN'S COLL., 1889.]

As the integral stands, summation is conducted over the infinite region bounded by the line $y=x$, the y -axis, and an infinite boundary, say $y=a$, where a is infinitely large, and along which the subject of integration $\frac{e^{-y}}{y}$ is ultimately zero, the strips being taken parallel to the y -axis.

Change the order of integration, taking strips parallel to the x -axis.

The new limits are : for x , from $x=0$ to $x=y$

and for y , from $y=0$ to $y=a$.

$$\begin{aligned}
 \text{And the integral becomes } Lt_{a=\infty} \int_0^a \int_0^y \frac{e^{-y}}{y} dy dx \\
 &= Lt_{a=\infty} \int_0^a \frac{e^{-y}}{y} [x]_0^y dy \\
 &= Lt_{a=\infty} \int_0^a e^{-y} dy \\
 &= Lt_{a=\infty} [-e^{-y}]_0^a \\
 &= Lt_{a=\infty} (1 - e^{-a}) = 1.
 \end{aligned}$$

Hence the value of the integral is unity.

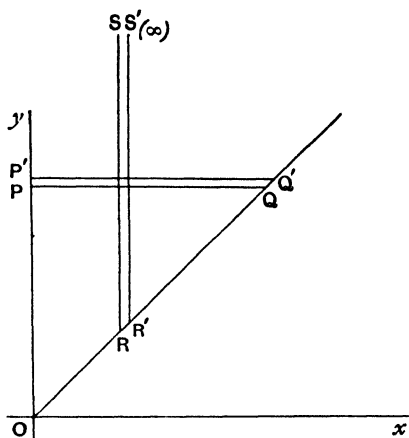

Fig. 302.

Ex. 8. Change the order of integration of the triple integral

$$\int_0^a \int_0^{a-x} \int_0^{a-x-y} f(x, y, z) dx dy dz$$

in all possible permutations of dx , dy , dz .

The integration referred to is evidently through the volume bounded by the three coordinate planes and the plane $x + y + z = a$.

The integration as it stands supposes this region divided into volume-elements $\delta x \delta y \delta z$ by means of slices or laminae parallel to the plane $x=0$, subdivided into tubes or prisms parallel to the z -axis, and these further subdivided into elementary cuboids by planes parallel to the plane $z=0$. The other modes of division and summation are obvious.

And the transformations are

$$\begin{aligned}
 \int_0^a \int_0^{a-x} \int_0^{a-x-z} f(x, y, z) dx dz dy, \\
 \int_0^a \int_0^{a-y} \int_0^{a-y-z} f(x, y, z) dy dz dx,
 \end{aligned}$$

$$\int_0^a \int_0^{a-y} \int_0^{a-x-y} f(x, y, z) dy dx dz,$$

$$\int_0^a \int_0^{a-z} \int_0^{a-z-x} f(x, y, z) dz dx dy,$$

$$\int_0^a \int_0^{a-z} \int_0^{a-y-z} f(x, y, z) dz dy dx.$$

Ex. 9. Express the integral

$$\int_0^a \int_0^{\sqrt{\frac{1}{2} \sqrt{a^2 - x^2}}} \int_y^{\sqrt{a^2 - x^2 - y^2}} f(x, y, z) dx dy dz$$

as an integral of the form

$$\iiint f(x, y, z) dy dz dx.$$

In the first integral the region over which the summation is conducted is bounded by

- (1) the sphere $x^2 + y^2 + z^2 = a^2$,
- (2) the plane $y = 0$,
- (3) the plane $x = 0$,
- (4) the plane $z = y$.

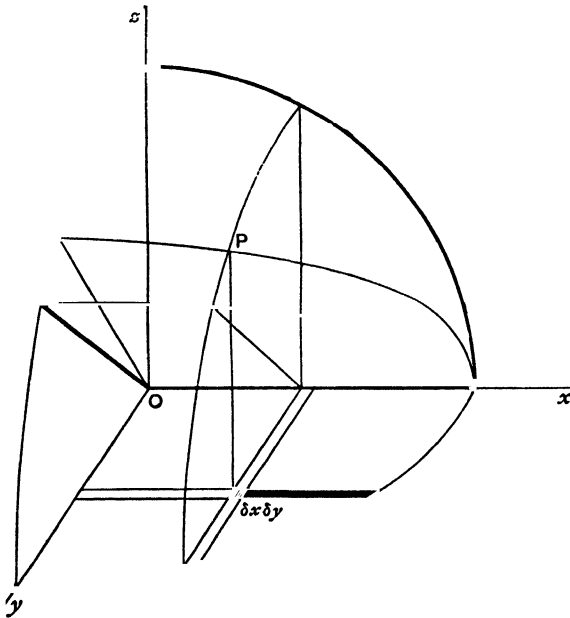

Fig. 303.

and the first integration was that of elementary cuboids in the tubes on $\delta x \delta y$ for base and parallel to the z -axis. The second with regard to y

added the tubes in a slice parallel to the plane $x=0$, and the third, integrated with regard to x , added up the slices.

We are now to construct tubes on $\delta y \delta z$ for base, and the limits for the first integration will be for x from 0 to $\sqrt{a^2 - y^2 - z^2}$.

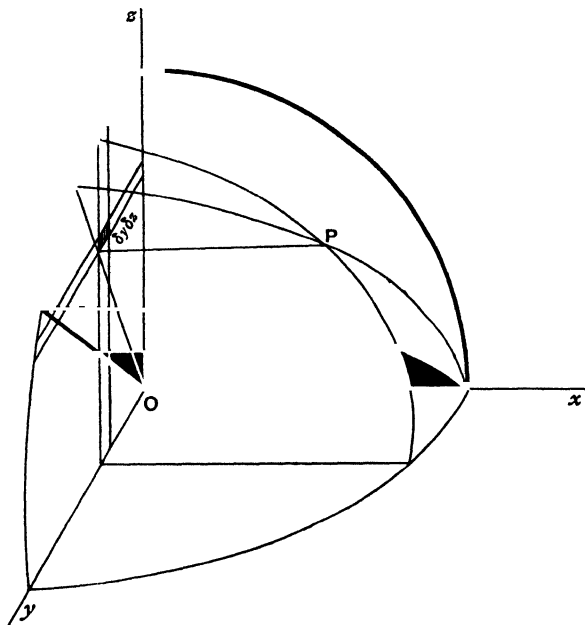

Fig. 304.

Then we are to sum these tubes which are bounded on two sides by planes parallel to the plane of $y=0$, and the limits for z are from $z=y$ to $z=\sqrt{a^2 - y^2}$.

Finally the slices thus formed are to be added from $y=0$ to $y=\frac{a}{\sqrt{2}}$.

The transformed integral is therefore

$$\int_0^{\frac{a}{\sqrt{2}}} \int_y^{\sqrt{a^2 - y^2}} \int_0^{\sqrt{a^2 - y^2 - z^2}} f(x, y, z) dy dz dx.$$

830. Examples of Change of the Variables.

We shall use the notation V for any function of the original variables and V' for the same function expressed in terms of the new variables.

In the case of change from Cartesians to Polars for two-dimension problems, the element of area $\delta x \delta y$ is replaced by $r \delta \theta \delta r$, and for three-dimension problems $\delta x \delta y \delta z$ is replaced

by $r^2 \sin \theta \delta \theta \delta \phi \delta r$. In converting from three-dimension Cartesians to cylindrical coordinates $\delta x \delta y \delta z$ is replaced by the new element of volume $r \delta \theta \delta r \delta z$.

It is convenient to remember these, as the labour of calculating the new element from the general result, viz.

$$J \delta u \delta v \delta w \quad \text{or} \quad \frac{\partial(x, y, z)}{\partial(u, v, w)} \delta u \delta v \delta w$$

is in these cases thereby avoided.

831. Illustrative Examples.

Ex. 1. Show that $\int_0^c \int_0^{c-x} V dx dy = \int_0^1 \int_0^c V'u dv du$, [COLLEGES, 1881.]
if $y+x=u, y=uv$.

(Jacobi's Transformation, *Crelle's Journal*, vol. xi. p. 307.*)

Here

$$\begin{aligned} x &= u(1-v), & y &= uv, \\ J &= \begin{vmatrix} 1-v, & -u \\ v, & u \end{vmatrix} = u. \end{aligned}$$

Hence

$$J \delta u \delta v = u \delta u \delta v.$$

Also V upon transformation becomes V' .

The transformed result therefore becomes

$$\iint V'u dv du \quad \text{or} \quad \iint V'u du dv,$$

according as we are to integrate with regard to u or with regard to v first.

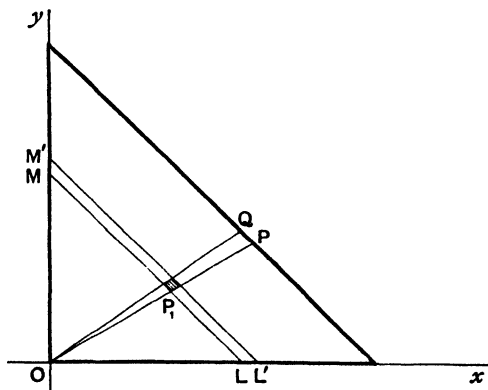

Fig. 305.

In our example the former is the case. We now have to determine the proper limits of integration.

In the original form the integration was for y from 0 to $c-x$ and for x from 0 to c .

* Gregory's *Examples*, p. 41.

The region through which the integration is to be conducted is then that bounded by the axes and the straight line $x+y=c$.

The transformation formulae

$$x+y=u, \quad y=\frac{v}{1-v}x$$

indicate that the new division of the area is to be by means of lines drawn parallel to $x+y=c$ and by radial lines through the origin, the lines $u, u+\delta u, v, v+\delta v$ bounding the element whose area has already been formed, viz. $u \delta u \delta v$.

Let these lines be $LM, L'M', OP, OQ$ respectively. Then as we are to integrate first with regard to u , keeping v constant, we are to add up all the elements in the triangle OPQ , and afterwards add up the elementary triangles. In passing from O to P u increases from $u=0$ to $u=c$.

Hence the first integration is $\int_0^c V'u \, du$.

In the second integration $\frac{v}{1-v}$ changes from $\tan 0$ (i.e. 0) to $\tan 90^\circ$ (i.e. ∞), and v changes from 0 to 1. Hence the transformed result is

$$\int_0^1 \int_0^c V'u \, dv \, du.$$

If we had elected to integrate in the opposite order the result would have been

$$\int_0^c \int_0^1 V'u \, du \, dv.$$

Ex. 2. Change the variables in $\iint dx \, dy$ to u, v , where $x^2+y^2=u$, $x^2-y^2=v$; and apply the result to show that the area included between the circles $x^2+y^2=a^2$, $x^2+y^2=b^2$, one branch of the hyperbola $x^2-y^2=c^2$ and the axis of y is

$$\frac{\pi}{8} (b^2 - a^2) + \frac{b^2}{4} \sin^{-1} \frac{c^2}{b^2} - \frac{a^2}{4} \sin^{-1} \frac{c^2}{a^2} + \frac{c^2}{4} \log \frac{b^2 + \sqrt{b^4 - c^4}}{a^2 + \sqrt{a^4 - c^4}},$$

where $c < a < b$.

(R.P.)

Here

$$J' = \begin{vmatrix} 2x & 2y \\ 2x & -2y \end{vmatrix} = -8xy,$$

and therefore

$$J = -\frac{1}{8} \frac{1}{xy} = -\frac{1}{4} \frac{1}{\sqrt{u^2 - v^2}},$$

and the transformed integral is $-\frac{1}{4} \iint \frac{du \, dv}{\sqrt{u^2 - v^2}}$, where it remains to assign the proper limits.

The region over which summation is to be conducted is the portion $ABECDF$ of Fig. 306.

If OFE be the asymptote of the rectangular hyperbola, the area of the portion $FECD$ is plainly $\frac{1}{2}(\pi b^2 - \pi a^2)$. We have then to turn our attention to the portion $ABEF$. And for this the line FE is a case of rectangular hyperbola, viz. $v=0$. Hence for this region the limits are

constant, viz. $u=a^2$ and $u=b^2$, $v=0$ to $v=c^2$, and with this assignment of limits we may omit the - sign and take

$$\begin{aligned} \text{Area } ABEF &= \frac{1}{4} \int_{a^2}^{b^2} \int_0^{c^2} \frac{du dv}{\sqrt{u^2 - v^2}} \\ &= \frac{1}{4} \int_{a^2}^{b^2} \left[\sin^{-1} \frac{v}{u} \right]_{v=0}^{v=c^2} du \\ &= \frac{1}{4} \int_{a^2}^{b^2} \sin^{-1} \frac{c^2}{u} du \\ &= \frac{1}{4} \left[u \sin^{-1} \frac{c^2}{u} \right]_{a^2}^{b^2} + \frac{1}{4} \int_{a^2}^{b^2} \frac{c^2}{\sqrt{u^2 - c^4}} du \\ &= \frac{1}{4} \left[u \sin^{-1} \frac{c^2}{u} + c^2 \cosh^{-1} \frac{u}{c^2} \right]_{a^2}^{b^2} \\ &= \frac{b^2}{4} \sin^{-1} \frac{c^2}{b^2} - \frac{a^2}{4} \sin^{-1} \frac{c^2}{a^2} + \frac{c^2}{4} \log \frac{b^2 + \sqrt{b^4 - c^4}}{a^2 + \sqrt{a^4 - c^4}}. \end{aligned}$$

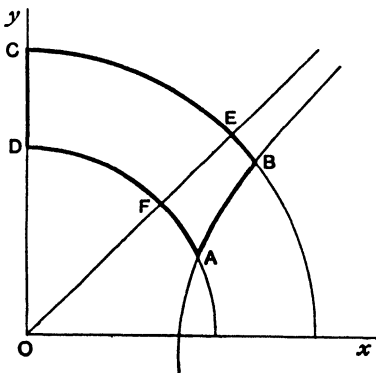

Fig. 306.

Hence adding the portion $FECD$ already found, we have

Area of $ABECDFA$

$$= \frac{\pi}{8} (b^2 - a^2) + \frac{b^2}{4} \sin^{-1} \frac{c^2}{b^2} - \frac{a^2}{4} \sin^{-1} \frac{c^2}{a^2} + \frac{c^2}{4} \log \frac{b^2 + \sqrt{b^4 - c^4}}{c^2 + \sqrt{a^4 - c^4}}.$$

Ex. 3. Show by transforming to polar coordinates that

$$\begin{aligned} \int_0^{\alpha \tan \alpha} \int_0^{\alpha \tan \beta} \frac{dx dy}{(x^2 + y^2 + a^2)^2} \\ = \frac{1}{2a^2} \{ \sin \alpha \tan^{-1}(\tan \beta \cos \alpha) + \sin \beta \tan^{-1}(\tan \alpha \cos \beta) \}. \end{aligned}$$

[COLLEGES, 1887.]

Putting $x=r \cos \theta$, $y=r \sin \theta$ and remembering that the element of area $\delta x \delta y$ is replaced in polars by $r \delta \theta \delta r$, we have $\iint \frac{r dr d\theta}{(r^2 + a^2)^2}$; and it remains to assign the limits for r and θ .

The region of integration is the rectangle bounded by $x=0$, $x=a \tan \alpha$, $y=0$, $y=a \tan \beta$. If γ be the angle which the diagonal through the origin makes with the x -axis, $\tan \gamma = \frac{\tan \beta}{\tan \alpha}$.

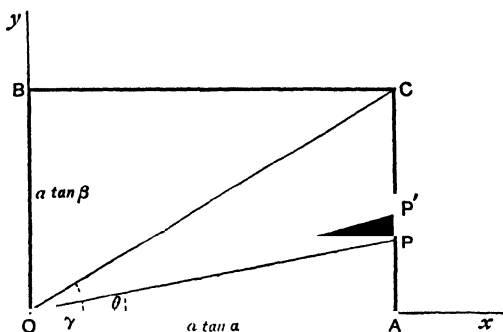

Fig. 307.

The whole integration consists of two parts, viz.

$$\int_0^{\gamma} \int_0^{a \tan \alpha \sec \theta} \frac{r \, d\theta \, dr}{(r^2 + a^2)^2} + \int_{\gamma}^{\frac{\pi}{2}} \int_0^{a \tan \beta \operatorname{cosec} \theta} \frac{r \, d\theta \, dr}{(r^2 + a^2)^2},$$

the first referring to the portion of the rectangle between the diagonal and the x -axis, and the second to the part between the diagonal and the y -axis.

This is clearly

$$\begin{aligned} & \frac{1}{2} \int_0^{\gamma} \left[-\frac{1}{r^2 + a^2} \right]_0^{a \tan \alpha \sec \theta} d\theta + \frac{1}{2} \int_{\gamma}^{\frac{\pi}{2}} \left[-\frac{1}{r^2 + a^2} \right]_0^{a \tan \beta \operatorname{cosec} \theta} d\theta \\ &= \frac{1}{2a^2} \int_0^{\gamma} \left(1 - \frac{\cos^2 \theta}{\cos^2 \theta + \tan^2 \alpha} \right) d\theta + \frac{1}{2a^2} \int_{\gamma}^{\frac{\pi}{2}} \left(1 - \frac{\sin^2 \theta}{\sin^2 \theta + \tan^2 \beta} \right) d\theta \\ &= \frac{1}{2a^2} \int_0^{\gamma} \frac{\tan^2 \alpha \, d\theta}{\sec^2 \alpha \cos^2 \theta + \tan^2 \alpha \sin^2 \theta} + \frac{1}{2a^2} \int_{\gamma}^{\frac{\pi}{2}} \frac{\tan^2 \beta \, d\theta}{\sec^2 \beta \sin^2 \theta + \tan^2 \beta \cos^2 \theta} \\ &= \frac{1}{2a^2} \int_0^{\gamma} \frac{\sec^2 \theta \, d\theta}{\operatorname{cosec}^2 \alpha + \tan^2 \theta} + \frac{1}{2a^2} \int_{\gamma}^{\frac{\pi}{2}} \frac{\operatorname{cosec}^2 \theta \, d\theta}{\operatorname{cosec}^2 \beta + \cot^2 \theta} \\ &= \frac{1}{2a^2} \left[\sin \alpha \tan^{-1}(\sin \alpha \tan \theta) \right]_0^{\gamma} + \frac{1}{2a^2} \left[\sin \beta \tan^{-1}(\sin \beta \cot \theta) \right]_{\frac{\pi}{2}}^{\gamma} \\ &= \frac{1}{2a^2} \sin \alpha \tan^{-1}(\cos \alpha \tan \beta) + \frac{1}{2a^2} \sin \beta \tan^{-1}(\cos \beta \tan \alpha). \end{aligned}$$

Ex. 4. Two lemniscates whose equations are $r^2 = a_1^2 \cos 2\theta$ and $r^2 = b_1^2 \sin 2\theta$ respectively, are drawn through a point P , and two others whose respective equations are $r^2 = a_2^2 \cos 2\theta$ and $r^2 = b_2^2 \sin 2\theta$ are drawn through Q . P and Q are both in the first quadrant. The remaining intersections of the four curves in the first quadrant are R and S . The coordinates of these points are respectively (r_1, θ_1) , (r_2, θ_2) , (r_3, θ_3) , (r_4, θ_4) .

It is required to show that the curvilinear quadrilateral thus enclosed has an area

$$\frac{1}{2} \left\{ \left(\frac{r_3^2}{\sin 4\theta_3} + \frac{r_4^2}{\sin 4\theta_4} \right) - \left(\frac{r_1^2}{\sin 4\theta_1} + \frac{r_2^2}{\sin 4\theta_2} \right) \right\}.$$

Considering the two types $r^2 = u^{\frac{1}{2}} \cos 2\theta$, $r^2 = v^{\frac{1}{2}} \sin 2\theta$, we obtain

$$r^4 \left(\frac{1}{u} + \frac{1}{v} \right) = 1 \quad \text{and} \quad \tan 2\theta = \sqrt{\frac{v}{u}},$$

i.e.
$$r^4 = \frac{uv}{u+v}, \quad \theta = \frac{1}{2} \tan^{-1} \frac{u^{\frac{1}{2}}}{v^{\frac{1}{2}}}.$$

Hence
$$\frac{\partial(r, \theta)}{\partial(u, v)} = \frac{1}{16r^3} \begin{vmatrix} v^2 & u^2 \\ u^{-\frac{1}{2}}v^{\frac{1}{2}} & -u^{\frac{1}{2}}v^{-\frac{1}{2}} \end{vmatrix} \frac{1}{(u+v)^3} = -\frac{1}{16r} \frac{1}{(u+v)^{\frac{3}{2}}}.$$

Also
$$A = \iint r d\theta dr = \iint r \frac{\partial(r, \theta)}{\partial(u, v)} du dv = -\frac{1}{16} \iint \frac{du dv}{(u+v)^{\frac{3}{2}}}$$

The limits of integration are a_1^4 to a_2^4 for u , and b_1^4 to b_2^4 for v taking a positive sign before the integral.

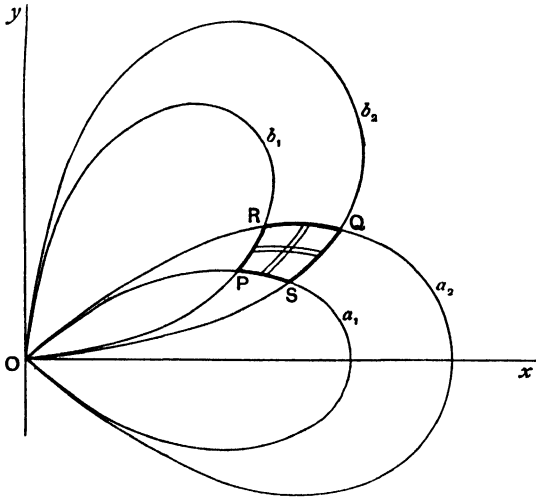

Fig. 308.

Hence
$$\begin{aligned} A &= \frac{1}{16} \int_{a_1^4}^{a_2^4} \int_{b_1^4}^{b_2^4} \frac{du dv}{(u+v)^{\frac{3}{2}}} \\ &= \frac{1}{16} \int_{a_1^4}^{a_2^4} \left[-\frac{2}{(u+v)^{\frac{1}{2}}} \right]_{b_1^4}^{b_2^4} du \\ &= \frac{1}{8} \int_{a_1^4}^{a_2^4} \left\{ \frac{1}{(b_1^4+u)^{\frac{1}{2}}} - \frac{1}{(b_2^4+u)^{\frac{1}{2}}} \right\} du \\ &= \frac{1}{4} \left[(b_1^4+u)^{\frac{1}{2}} - (b_2^4+u)^{\frac{1}{2}} \right]_{a_1^4}^{a_2^4} \\ &= \frac{1}{4} [(b_1^4+a_2^4)^{\frac{1}{2}} - (b_2^4+a_2^4)^{\frac{1}{2}} - (b_1^4+a_1^4)^{\frac{1}{2}} + (b_2^4+a_1^4)^{\frac{1}{2}}] \end{aligned}$$

Now the curves a_1, b_1 intersect at r_1, θ_1 , and

$$a_1^4 + b_1^4 = \frac{r_1^4}{\cos^2 2\theta_1} + \frac{r_1^4}{\sin^2 2\theta_1} = \frac{4r_1^4}{\sin^2 4\theta_1}.$$

Similarly,

$$a_1^4 + b_2^4 = \frac{4r_1^4}{\sin^2 4\theta_1}, \quad a_2^4 + b_1^4 = \frac{4r_2^4}{\sin^2 4\theta_2}, \quad \text{and} \quad a_2^4 + b_2^4 = \frac{4r_2^4}{\sin^2 4\theta_2}.$$

$$\text{Hence} \quad A = \frac{1}{2} \left[\frac{r_3^2}{\sin 4\theta_3} + \frac{r_4^2}{\sin 4\theta_4} - \frac{r_1^2}{\sin 4\theta_1} - \frac{r_2^2}{\sin 4\theta_2} \right].$$

Ex. 5. Transform the integral $\int_0^{\frac{\pi}{2}} \int_0^{\frac{\pi}{2}} \sqrt{\frac{\sin \phi}{\sin \theta}} d\phi d\theta$ by the substitution

$$x = \sin \phi \cos \theta, \quad y = \sin \phi \sin \theta,$$

and show that its value is π .

[OXFORD II. P., 1880.]

$$\begin{aligned} \text{Here} \quad J &\equiv \frac{\partial(x, y)}{\partial(\phi, \theta)} = \begin{vmatrix} \cos \phi \cos \theta & -\sin \phi \sin \theta \\ \cos \phi \sin \theta & \sin \phi \cos \theta \end{vmatrix} \\ &= \sin \phi \cos \phi \end{aligned}$$

$$\begin{aligned} \text{and} \quad \iint \sqrt{\frac{\sin \phi}{\sin \theta}} d\phi d\theta &= \iint \frac{1}{\sin \phi \cos \phi} \sqrt{\frac{\sin \phi}{\sin \theta}} dy dx \\ &= \iint \frac{1}{\sqrt{y} \sqrt{1-x^2-y^2}} dy dx. \end{aligned}$$

The original limits were $\theta=0$ to $\theta=\frac{\pi}{2}$ and $\phi=0$ to $\phi=\frac{\pi}{2}$.

Now $x^2 + y^2 = \sin^2 \phi$ and $\frac{y}{x} = \tan \theta$.

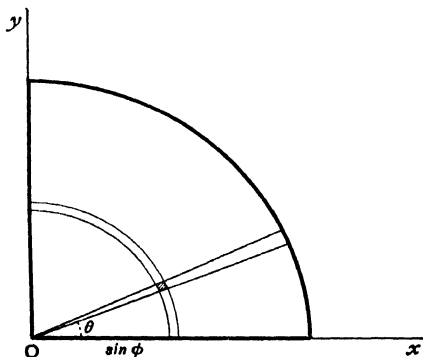

Fig. 309.

We may then regard the integration as extending through the positive quadrant of the circle $x^2 + y^2 = 1$. The limits for x will then be from $x=0$ to $x=\sqrt{1-y^2}$, and for y from $y=0$ to $y=1$.

Keeping y constant

$$\begin{aligned} & \int_0^1 \int_0^{\sqrt{1-y^2}} \frac{1}{\sqrt{y} \sqrt{1-x^2-y^2}} dy dx \\ &= \int_0^1 \frac{1}{\sqrt{y}} \left[\sin^{-1} \frac{x}{\sqrt{1-y^2}} \right]_0^{\sqrt{1-y^2}} dy \\ &= \int_0^1 \frac{1}{\sqrt{y}} \cdot \frac{\pi}{2} dy = \frac{\pi}{2} \left[2\sqrt{y} \right]_0^1 = \pi. \end{aligned}$$

Ex. 6. Show that if $x=u(1+v)$ and $y=v(1+u)$,

$$\int_0^2 \int_0^x \{(x-y)^2 + 2(x+y) + 1\}^{-\frac{1}{2}} dx dy = \int_0^1 \int_v^{1+v} dv du,$$

and prove the identity by finding the value of each integral.

Here $J = \begin{vmatrix} 1+v, & u \\ v, & 1+u \end{vmatrix} = 1+u+v$

[OXFORD II. P., 1889.]

and $(x-y)^2 + 2(x+y) + 1 = (u-v)^2 + 2(u+v) + 4uv + 1 = (u+v+1)^2$.

Hence $\iint \{(x-y)^2 + 2(x+y) + 1\}^{-\frac{1}{2}} dx dy = \iint dv du$.

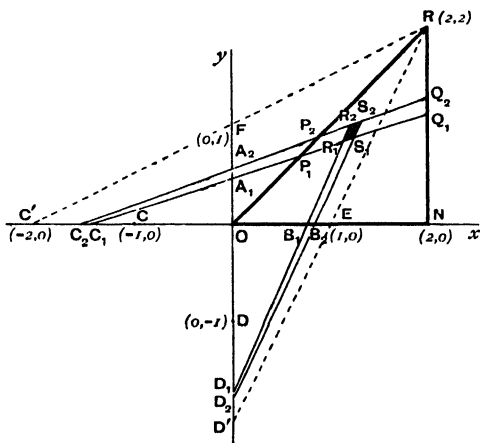

Fig. 310.

Next consider the limits. The region through which the summation in the first integral is to be effected is that bounded by the x -axis, the line $y=x$, and the ordinate $x=2$; *i.e.* the triangle ONR in the accompanying figure (Fig. 310).

The loci $u=\text{const.}$, $v=\text{const.}$ are respectively the lines

$$\frac{x}{u} - \frac{y}{1+u} = 1, \quad \frac{y}{v} - \frac{x}{1+v} = 1.$$

We are to integrate first with regard to u , keeping v constant, *i.e.* along a strip formed by the lines $v, v + \delta v$. These lines, represented by $C_1A_1P_1Q_1$ and $C_2A_2P_2Q_2$ respectively in the figure, form a strip of gradually widening breadth in passing from P to Q , for, as the intercept OC_1 on the x -axis increases (negatively), the line rotates counterclockwise. It begins its rotation, as far as our triangle is concerned, with coincidence with ON , for which $v=0$, and ends its rotation when $v=1$, when the line is $\frac{y}{1} - \frac{x}{2} = 1$, and passes through $R(2, 2)$, taking the position $C'R$. Now along the whole length of OR , *i.e.* $y=x$, we have $u=v$, and along the whole length of NR , *i.e.* $x=2$, we have $2 = u(1+v)$, *i.e.* $u = \frac{2}{1+v}$.

Hence, in integrating along the strip $P_1Q_1Q_2P_2$, keeping $v = \text{constant}$ u changes from $u=v$ at P_1 to $u = \frac{2}{1+v}$ at Q_1 .

Hence the limits for u are v and $\frac{2}{1+v}$, and for v , 0 and 1.

$$\text{Hence } \int_0^2 \int_0^x \{(x-y)^2 + 2(x+y) + 1\}^{\frac{1}{2}} dx dy = \int_0^1 \int_v^{\frac{2}{1+v}} dv du.$$

The student may show without difficulty that each side of the identity takes the value $2 \log 2 - \frac{1}{2}$.

If, however, the integration had been conducted in the reverse order, integrating first for strips along which u is constant, it is to be noted that the character of such strips changes when the line $D_1B_1R_1$ passes through $E(1, 0)$, the strips being terminated by OE ($r=0$) and OR ($v=u$) for the portion OER and by EN ($v=0$) and NR ($v = \frac{2}{u} - 1$) for the second part.

$$\text{We then have } \int_0^1 du \int_0^u dv + \int_1^2 du \int_0^{u-1} dv.$$

Ex. 7. Obtain the value of

$$I \equiv \iiint \sqrt{\frac{1 - \left(\frac{x^2}{a^2} + \frac{y^2}{b^2} + \frac{z^2}{c^2}\right)^{\frac{1}{2}}}{1 + \left(\frac{x^2}{a^2} + \frac{y^2}{b^2} + \frac{z^2}{c^2}\right)^{\frac{1}{2}}}} dx dy dz,$$

the integral being taken for all values of x, y, z , such that

$$\frac{x^2}{a^2} + \frac{y^2}{b^2} + \frac{z^2}{c^2} < 1.$$

We shall divide up the ellipsoidal volume into a set of thin homoeoidal shells, that is shells bounded by ellipsoidal surfaces, concentric, similar and similarly situated with the bounding surface. Let a typical member of this family of surfaces be

$$\frac{x^2}{a^2} + \frac{y^2}{b^2} + \frac{z^2}{c^2} = \rho^2,$$

ρ lying between 0 and 1.

Then the volume of the shell bounded by ρ and $\rho + \delta\rho$ is

$$\delta\left\{\frac{1}{3}\pi(a\rho)(b\rho)(c\rho)\right\} = 4\pi abc\rho^2\delta\rho,$$

and the value of $\frac{x^2}{a^2} + \frac{y^2}{b^2} + \frac{z^2}{c^2}$ at points between the boundaries of the shell differs from ρ^2 by an infinitesimal only.

Hence
$$I = \int_0^1 \sqrt{\frac{1-\rho}{1+\rho}} \cdot 4\pi abc\rho^2 d\rho.$$

Write $\rho = \cos \phi$.

Then
$$\begin{aligned} I &= \int_0^{\frac{\pi}{2}} \sqrt{\frac{1-\cos\phi}{1+\cos\phi}} \cdot 4\pi abc \cdot \cos^2\phi \sin\phi d\phi \\ &= 4\pi abc \int_0^{\frac{\pi}{2}} (1-\cos\phi)\cos^2\phi d\phi \\ &= 4\pi abc \left(\frac{1}{2}\frac{\pi}{2} - \frac{2}{3}\right) \\ &= \frac{1}{3}\pi abc(3\pi - 8). \end{aligned}$$

Ex. 8. If $xu + yv = a^2$ and $xv - yu = 0$, prove that

$$\iint V dx dy = - \iint \frac{V' a^4 du dv}{(u^2 + v^2)^2}.$$

And if the limits in the former integral are $y=0$ to $y=\sqrt{a^2-x^2}$ and $x=0$ to $x=a$, investigate the limits in the latter. [ST. JOHN'S, 1885.]

Here
$$x = \frac{a^2 u}{u^2 + v^2}, \quad y = \frac{a^2 v}{u^2 + v^2},$$

and
$$J = \frac{a^4}{(u^2 + v^2)^4} \begin{vmatrix} v^2 - u^2 & -2uv \\ -2uv & u^2 - v^2 \end{vmatrix} = -\frac{a^4}{(u^2 + v^2)^2};$$

whence
$$\iint V dx dy = - \iint \frac{V' a^4 du dv}{(u^2 + v^2)^2},$$

where V' is what V becomes after substitution for x and y in terms of u and v .

Next, as to the limits. In $\int_0^a \int_0^{\sqrt{a^2-x^2}} V dx dy$ the integration is over the region bounded by the positive quadrant of the circle $x^2 + y^2 = a^2$.

Eliminating v and u alternately, we have

$$x^2 + y^2 - \frac{a^2}{u} x = 0, \quad x^2 + y^2 - \frac{a^2}{v} y = 0,$$

and the curves $u = \text{const.}$, $v = \text{const.}$, are orthogonal circles touching the axes at the origin. Let us integrate first with regard to v , then with regard to u . Whilst integrating with regard to v , the element $J \delta u \delta v$ is bounded always by the two complete semicircles u and $u + \delta u$, so long as this ring lies entirely within the circle $x^2 + y^2 = a^2$, and the limits for v are from the case where the v -curve is a circle of infinite radius coinciding with the x -axis, to the case where it is a point circle at the origin. The

radius is $\frac{a^2}{2v}$. Hence the limits for v are from $v=0$ to $v=\infty$. And the u -circle has a radius $\frac{a^2}{2u}$, and changes from a circle of radius $\frac{a}{2}$ to a circle of radius zero, *i.e.* u changes from $u=a$ to $u=\infty$.

When the u -circle has a radius in excess of $\frac{a}{2}$, the limits for v will be from the value of v for which the u -circle cuts the v -circle, *viz.* at P , in Fig. 311, to the value of v for which the v -circle becomes a point-circle at the origin, *i.e.* when $v=\infty$.

Now at P we have

$$\frac{a^2}{v}y = x^2 + y^2 = a^2 \quad \text{and} \quad \frac{a^2}{u}x = a^2,$$

i.e. at that point $x=u$ and $y=v$, whence $v^2 = a^2 - u^2$.

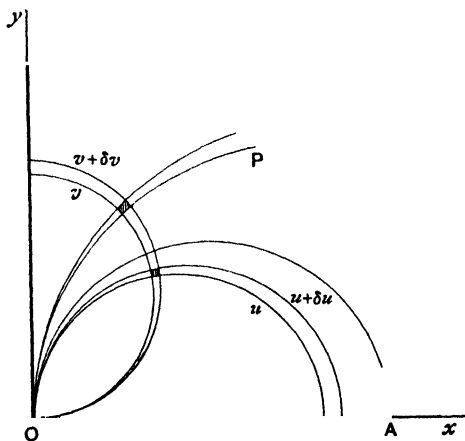

Fig. 311.

Hence the limits for v are from $\sqrt{a^2 - u^2}$ to ∞ , and u now varies between the value which makes the u -circle a straight line coincident with the y -axis, *i.e.* $u=0$, and the value of u which gives a semicircle on the radius OA , *i.e.* $u=a$. Thus the integration referred to divides into two portions, the first referring to the portion of the quadrant included in a semicircle on OA for diameter, and the other to the remainder of the quadrant.

Thus

$$\int_0^a \int_0^{\sqrt{a^2 - x^2}} V \, dx \, dy = a^4 \int_a^\infty \int_0^\infty \frac{V' \, du \, dv}{(u^2 + v^2)^2} + a^4 \int_0^a \int_{\sqrt{a^2 - u^2}}^\infty \frac{V' \, du \, dv}{(u^2 + v^2)^2}.$$

It may be observed that the transformation formulae $x = \frac{a^2 u}{u^2 + v^2}$, $y = \frac{a^2 v}{u^2 + v^2}$ indicate an inversion from the Cartesian coordinates x, y of a point within the circle, with a for the constant of inversion, to a point whose coordi-

nates are u, v , which lies without the circle. Hence as (x, y) is to traverse the *interior* of the quadrant of the circle, (u, v) is to traverse the portion of the first quadrant of space which lies *outside* the quadrant of the circle, and therefore, the circle having equation $u^2 + v^2 = a^2$ in the new coordinates, the limits must be

$$v = \sqrt{a^2 - u^2} \text{ to } v = \infty \text{ from } u = 0 \text{ to } u = a,$$

and $v = 0$ to $v = \infty$ from $u = a$ to $u = \infty$,

which agrees with the result stated.

Ex. 9. Obtain the value of the integral

$$I \equiv \iint \phi'(Ax^2 + 2Bxy + Cy^2) dx dy,$$

extended to all values of x, y which satisfy the condition

$$Ax^2 + 2Bxy + Cy^2 \leq 1,$$

A and C being supposed positive, and $AC - B^2 > 0$.

The conditions given indicate integration within the area bounded by the ellipse

$$Ax^2 + 2Bxy + Cy^2 = 1.$$

Divide this area up by a family of similar and similarly situated concentric ellipses, of which a type is

$$Ax^2 + 2Bxy + Cy^2 = t,$$

t varying from 0 to 1.

The equation to find the semi-axes of this ellipse is

$$\frac{1}{\rho^4} - \frac{A+C}{t} \frac{1}{\rho^2} + \frac{AC-B^2}{t^2} = 0, \quad [\text{SMITH, } \textit{Conic Sections}, \text{ Art. 171.}]$$

and its area is

$$\pi \frac{t}{\sqrt{AC-B^2}}.$$

Hence the area of the annulus bounded by the ellipses t and $t + \delta t$ is

$$\pi \frac{\delta t}{\sqrt{AC-B^2}},$$

and $\phi'(Ax^2 + 2Bxy + Cy^2)$ only differs from $\phi'(t)$ by an infinitesimal at any point of this ring.

$$\begin{aligned} \text{Hence in the limit} \quad I &= \int_0^1 \phi'(t) \cdot \pi \frac{dt}{\sqrt{AC-B^2}} \\ &= \pi \frac{\phi(1) - \phi(0)}{\sqrt{AC-B^2}}. \end{aligned}$$

Ex. 10. Prove that $\iint du dv$ over a portion of the surface $w = 0$ is

$$\iint \frac{\partial(u, v, w)}{\partial(x, y, z)} \frac{dS}{\left\{ \left(\frac{\partial w}{\partial x} \right)^2 + \left(\frac{\partial w}{\partial y} \right)^2 + \left(\frac{\partial w}{\partial z} \right)^2 \right\}^{\frac{1}{2}}},$$

u, v, w being functions of x, y, z .

Let x, y, z be a point on the surface $w = 0$ at which an element of the normal is δn . Then $\delta n = \frac{\delta w}{h}$, where $h^2 = w_x^2 + w_y^2 + w_z^2$ (Art. 789).

Also $\delta S \cdot \delta n$ is an element of volume, and may be replaced in volume-integration by

$$\frac{\partial(x, y, z)}{\partial(u, v, w)} \delta u \delta v \delta w \quad (\text{Art. 794}),$$

i.e. $\delta S \cdot \frac{\delta w}{h}$ may be replaced by $\frac{1}{\frac{\partial(u, v, w)}{\partial(x, y, z)}} \delta u \delta v \delta w$

and
$$\iint du dv = \iint \frac{\partial(u, v, w)}{\partial(x, y, z)} \frac{dS}{h}.$$

Ex. 11. Prove that $I \equiv \iiint dx dy dz dw$ for all values of the variables for which $x^2 + y^2 + z^2 + w^2$ is not less than a^2 and not greater than b^2 is

$$= \frac{\pi^2}{2} (b^4 - a^4).$$

In this case we cannot appeal immediately to a figure to help in the determination of the limits.

We may at first ignore the condition that $x^2 + y^2 + z^2 + w^2$ is not less than a^2 , and let the variables have full range of any values up to such as will make $x^2 + y^2 + z^2 + w^2 = b^2$. We shall then subtract the result for such as make the variables in the extreme case such that $x^2 + y^2 + z^2 + w^2 > a^2$.

In the first integration, keeping x, y, z fixed, w ranges through all values from $-\sqrt{b^2 - x^2 - y^2 - z^2}$ to $+\sqrt{b^2 - x^2 - y^2 - z^2}$, and

$$\begin{aligned} \iiint dx dy dz dw &= \iiint [w] dx dy dz \\ &= 2 \iiint \int \sqrt{b^2 - x^2 - y^2 - z^2} dx dy dz. \end{aligned}$$

In this integral, keeping x and y constant, z ranges from

$$z = -\sqrt{b^2 - x^2 - y^2} \text{ to } z = +\sqrt{b^2 - x^2 - y^2},$$

and $\int \sqrt{b^2 - x^2 - y^2 - z^2} dz = \frac{z\sqrt{b^2 - x^2 - y^2 - z^2}}{2} + \frac{b^2 - x^2 - y^2}{2} \sin^{-1} \frac{z}{\sqrt{b^2 - x^2 - y^2}},$

x and y being constant during the integration. And inserting the limits,

$$\iiint \sqrt{b^2 - x^2 - y^2 - z^2} dx dy dz = \iint \frac{\pi}{2} (b^2 - x^2 - y^2) dx dy.$$

We have now reduced $\iiint dx dy dz dw$ to $2 \cdot \frac{\pi}{2} \iint (b^2 - x^2 - y^2) dx dy$; and now we are to integrate with regard to y , keeping x constant, and the limits for y are from $-\sqrt{b^2 - x^2}$ to $+\sqrt{b^2 - x^2}$.

Also
$$\int (b^2 - x^2 - y^2) dy = (b^2 - x^2)y - \frac{y^3}{3},$$

and

$$= 2 \left[\frac{2}{3} (b^2 - x^2)^{\frac{3}{2}} \right]$$

when the limits are taken.

We have now arrived at $\frac{4}{3}\pi \int (b^2 - x^2)^{\frac{3}{2}} dx$, the limits for x being from $-b$ to $+b$. Put $x = b \sin \theta$. The integral then becomes

$$2 \cdot \frac{4}{3} \pi \int_0^{\frac{\pi}{2}} b^3 \cos^3 \theta b \cos \theta d\theta \quad \text{or} \quad \frac{8}{3} \pi b^4 \frac{3}{4} \frac{1}{2} \frac{\pi}{2}, \quad \text{i.e.} \quad \frac{\pi^2}{2} b^4.$$

Now, in exactly the same way we may see, as is indeed obvious at once, that the amount included in excess by giving the variables free play up to the case $x^2 + y^2 + z^2 + w^2 = b^2$ instead of excluding those values which make $x^2 + y^2 + z^2 + w^2 < a^2$ is $\frac{\pi^2}{2} a^4$.

Hence the summation of the cases from

$$x^2 + y^2 + z^2 + w^2 = a^2 \quad \text{to} \quad x^2 + y^2 + z^2 + w^2 = b^2$$

is $\frac{\pi^2}{2} (b^4 - a^4)$.

It is clear also that after the first integration with regard to w had been completed we might for the remainder have illustrated the triple integral

$$\iiint \sqrt{b^2 - x^2 - y^2 - z^2} dx dy dz$$

by integration through a spherical volume, the summation being that of $\sqrt{b^2 - x^2 - y^2 - z^2}$ throughout the sphere $x^2 + y^2 + z^2 = b^2$.

Then writing $x^2 + y^2 + z^2 = r^2$, we have

$$\begin{aligned} I &= 2 \int_0^{2\pi} \int_0^{\pi} \int_0^b \sqrt{b^2 - r^2} r^2 \sin \theta d\theta d\phi dr \\ &= 8\pi \int_0^b r^2 \sqrt{b^2 - r^2} dr = 8\pi b^4 \int_0^{\frac{\pi}{2}} \sin^2 \chi \cos^2 \chi d\chi, \quad (r = b \sin \chi) \\ &= 8\pi b^4 \frac{\Gamma(\frac{3}{2})\Gamma(\frac{3}{2})}{2\Gamma(3)} = \frac{\pi^2 b^4}{2}, \quad \text{as before.} \end{aligned}$$

832. Case of an Implicit Relation between Two Sets of Variables.

In our previous work and in the typical examples discussed, we have regarded the transformation formulæ to be such that each of the one set of variables is expressed, or easily expressible, as an explicit function of the variables of the new group. If this be not so, we can still form the Jacobian by the rules of Arts. 543 and 544, *Diff. Calculus*.

For in the case when

$$f_1(x, y, u, v) = 0, \quad f_2(x, y, u, v) = 0$$

are the connecting equations, we have

$$\frac{\partial(f_1, f_2)}{\partial(x, y)} \cdot \frac{\partial(x, y)}{\partial(u, v)} = \frac{\partial(f_1, f_2)}{\partial(u, v)},$$

and when

$$\begin{aligned} f_1(x, y, z, u, v, w) &= 0, \\ f_2(x, y, z, u, v, w) &= 0, \\ f_3(x, y, z, u, v, w) &= 0, \end{aligned}$$

are the connecting formulae,

$$\frac{\partial(f_1, f_2, f_3)}{\partial(x, y, z)} \cdot \frac{\partial(x, y, z)}{\partial(u, v, w)} = (-1)^3 \frac{\partial(f_1, f_2, f_3)}{\partial(u, v, w)};$$

and generally, if there be n connecting equations,

$$f_1=0, f_2=0, f_3=0, \dots f_n=0,$$

between $2n$ variables,

$$u_1, u_2, \dots u_n \text{ and } x_1, x_2, \dots x_n,$$

$$\frac{\partial(f_1, f_2, \dots f_n)}{\partial(x_1, x_2, \dots x_n)} \cdot \frac{\partial(x_1, x_2, \dots x_n)}{\partial(u_1, u_2, \dots u_n)} = (-1)^n \frac{\partial(f_1, f_2, \dots f_n)}{\partial(u_1, u_2, \dots u_n)}.$$

Hence for a double integration

$$\iint V dx dy = \iint V' \frac{\frac{\partial(f_1, f_2)}{\partial(u, v)}}{\frac{\partial(f_1, f_2)}{\partial(x, y)}} du dv,$$

and for a triple integration

$$\iiint dx dy dz = - \iiint V' \frac{\frac{\partial(f_1, f_2, f_3)}{\partial(u, v, w)}}{\frac{\partial(f_1, f_2, f_3)}{\partial(x, y, z)}} du dv dw,$$

and so on.

DIGRESSION ON JACOBIANS. JACOBI'S AND BERTRAND'S DEFINITIONS.

833. **Jacobi's Definition.**

If $f_1, f_2, f_3, \dots f_n$ be any function of the n variables

$$x_1, x_2, x_3, \dots x_n,$$

the determinant

$$J \equiv \begin{vmatrix} \frac{\partial f_1}{\partial x_1}, & \frac{\partial f_1}{\partial x_2}, & \frac{\partial f_1}{\partial x_3}, & \dots & \frac{\partial f_1}{\partial x_n} \\ \frac{\partial f_2}{\partial x_1}, & \frac{\partial f_2}{\partial x_2}, & \frac{\partial f_2}{\partial x_3}, & \dots & \frac{\partial f_2}{\partial x_n} \\ \dots & \dots & \dots & \dots & \dots \\ \frac{\partial f_n}{\partial x_1}, & \frac{\partial f_n}{\partial x_2}, & \frac{\partial f_n}{\partial x_3}, & \dots & \frac{\partial f_n}{\partial x_n} \end{vmatrix}$$

is called the Jacobian of $f_1, f_2, f_3, \dots f_n$ with regard to $x_1, x_2, \dots x_n$. Jacobi in one of his memoirs pointed out the strong analogy which the properties of this function bears to those of a differential coefficient of a function of a single variable. This

resemblance of results, rather than of demonstrations, has already been mentioned (*Diff. Calculus*, Articles 542 onwards). It was by starting from the form of this determinant that Jacobi's investigation proceeded.

834. Bertrand's System of Increments.

A different standpoint was suggested by M. J. Bertrand in a memoir to the Académie des Sciences (1851), which has many advantages, and Jacobi's results may be deduced from M. Bertrand's new definitions almost as corollaries.

Let f_1, f_2, \dots, f_n be n functions of the n independent variables x_1, x_2, \dots, x_n .

Let us give to these independent variables the following n systems of increments, viz.

$$\left. \begin{array}{l} d_1x_1, \quad d_1x_2, \quad d_1x_3, \quad \dots \quad d_1x_n \\ d_2x_1, \quad d_2x_2, \quad d_2x_3, \quad \dots \quad d_2x_n \\ \text{etc.,} \\ d_nx_1, \quad d_nx_2, \quad d_nx_3, \quad \dots \quad d_nx_n \end{array} \right\}, \dots\dots\dots(A)$$

and let the corresponding increments in the several functions be

$$\left. \begin{array}{l} d_1f_1, \quad d_1f_2, \quad d_1f_3, \quad \dots \quad d_1f_n \\ d_2f_1, \quad d_2f_2, \quad d_2f_3, \quad \dots \quad d_2f_n \\ \text{etc.,} \\ d_nf_1, \quad d_nf_2, \quad d_nf_3, \quad \dots \quad d_nf_n \end{array} \right\}, \dots\dots\dots(B)$$

i.e. $d_r f_s$ is the increment of f_s when x_1, x_2, \dots , increase to $x_1 + d_r x_1, x_2 + d_r x_2, \dots$.

These several increments $d_1x_1, d_2x_1, d_3x_1, \dots$, though increments of the same variable, are arbitrary and independent, and there is reserved to us the power of making them equal later, or of assuming any such relations between them as we may subsequently choose.

It is clear that we have the n^2 relations of which

$$d_r f_s = \frac{\partial f_s}{\partial x_1} d_r x_1 + \frac{\partial f_s}{\partial x_2} d_r x_2 + \dots + \frac{\partial f_s}{\partial x_n} d_r x_n \dots\dots\dots(C)$$

is a type, it being unnecessary in the partial differential coefficients occurring to specify which of the particular increments we choose when we proceed to the limit in their formation.

835. **Bertrand's Definition of a Jacobian.**

M. Bertrand's definition of a Jacobian is that it is the ratio of the determinant formed by the increments of Group B to the determinant formed of the increments in Group A.

Now

$$\begin{aligned}
 & \begin{vmatrix} d_1x_1, & d_1x_2, & d_1x_3, & \dots, & d_1x_n \\ d_2x_1, & d_2x_2, & d_2x_3, & \dots, & d_2x_n \\ \dots & \dots & \dots & \dots & \dots \\ d_nx_1, & d_nx_2, & d_nx_3, & \dots, & d_nx_n \end{vmatrix} \times \begin{vmatrix} \frac{\partial f_1}{\partial x_1}, & \frac{\partial f_1}{\partial x_2}, & \dots, & \frac{\partial f_1}{\partial x_n} \\ \frac{\partial f_2}{\partial x_1}, & \frac{\partial f_2}{\partial x_2}, & \dots, & \frac{\partial f_2}{\partial x_n} \\ \dots & \dots & \dots & \dots \\ \frac{\partial f_n}{\partial x_1}, & \frac{\partial f_n}{\partial x_2}, & \dots, & \frac{\partial f_n}{\partial x_n} \end{vmatrix} \\
 = & \begin{vmatrix} d_1f_1, & d_1f_2, & d_1f_3, & \dots, & d_1f_n \\ d_2f_1, & d_2f_2, & d_2f_3, & \dots, & d_2f_n \\ \dots & \dots & \dots & \dots & \dots \\ d_nf_1, & d_nf_2, & d_nf_3, & \dots, & d_nf_n \end{vmatrix},
 \end{aligned}$$

by the rule of multiplication of determinants and by virtue of the equations of Group C.

Hence Bertrand's definition agrees with that of Jacobi. We have, however, gained command over the increments of the independent variables.

If we adopt the notation Df and Dx for the determinants

$$\begin{vmatrix} d_1f_1, & d_1f_2, & \dots \\ d_2f_1, & \dots, & \dots \\ \dots & \dots & \dots \\ d_nf_1, & \dots, & \dots \end{vmatrix} \quad \text{and} \quad \begin{vmatrix} d_1x_1, & d_1x_2, & \dots \\ d_2x_1, & \dots, & \dots \\ \dots & \dots & \dots \\ d_nx_1, & \dots, & \dots \end{vmatrix},$$

respectively, we have $J = \frac{Df}{Dx}$.

836. **Corollaries.**

1. It follows at once that if $F_1, F_2, \dots F_n$ be functions of $f_1, f_2, \dots f_n$, and $f_1, f_2, \dots f_n$ be functions of $x_1, x_2, \dots x_n$, then, since

$$\frac{DF}{Dx} = \frac{DF}{Df} \cdot \frac{Df}{Dx},$$

we have

$$\begin{aligned}
 \left\{ \begin{array}{l} \text{Jacobian of } F_1, F_2, \dots \\ \text{with regard to } x_1, x_2, \dots \end{array} \right\} &= \left\{ \begin{array}{l} \text{Jacobian of } F_1, F_2, \dots \\ \text{with regard to } f_1, f_2, \dots \end{array} \right\} \\
 &\times \left\{ \begin{array}{l} \text{Jacobian of } f_1, f_2, \dots \\ \text{with regard to } x_1, x_2, \dots \end{array} \right\}.
 \end{aligned}$$

2. Also, since $\frac{Df}{Dx} \times \frac{Dx}{Df} = 1$, we have

$$\left\{ \begin{array}{l} \text{Jacobian of } f_1, f_2, \dots \\ \text{with regard to } x_1, x_2, \dots \end{array} \right\} \times \left\{ \begin{array}{l} \text{Jacobian of } x_1, x_2, \dots \\ \text{with regard to } f_1, f_2, \dots \end{array} \right\} = 1.$$

3. Again, if $F_1=0, F_2=0, \dots F_r=0 \dots, F_n=0$ be n independent equations connecting n variables $u_1, u_2, \dots u_n$, and n other variables $x_1, x_2, \dots x_n$, then, since

$$\begin{aligned} \frac{\partial F_r}{\partial x_1} d_s x_1 + \frac{\partial F_r}{\partial x_2} d_s x_2 + \dots + \frac{\partial F_r}{\partial x_n} d_s x_n \\ + \frac{\partial F_r}{\partial u_1} d_s u_1 + \frac{\partial F_r}{\partial u_2} d_s u_2 + \dots + \frac{\partial F_r}{\partial u_n} d_s u_n = 0, \end{aligned}$$

we have

$$\frac{\partial F_r}{\partial x_1} d_s x_1 + \dots + \frac{\partial F_r}{\partial x_n} d_s x_n = - \left(\frac{\partial F_r}{\partial u_1} d_s u_1 + \dots + \frac{\partial F_r}{\partial u_n} d_s u_n \right),$$

which may be abbreviated into

$$d_{s,x} F_r = -d_{s,u} F_r, \dots \dots \dots (a)$$

the suffix x being attached to indicate those partial differential coefficients in which u_1, u_2, \dots are regarded as constant whilst x_1, x_2, \dots vary and *vice versa*.

Now $D_x F$ and $D_u F$ are the respective determinants

$$\left| \begin{array}{l} d_{1,x} F_1, d_{1,x} F_2, \dots d_{1,x} F_n \\ d_{2,x} F_1, d_{2,x} F_2, \dots d_{2,x} F_n \\ \dots \dots \dots \dots \dots \dots \\ d_{n,x} F_1, d_{n,x} F_2, \dots d_{n,x} F_n \end{array} \right| \text{ and } \left| \begin{array}{l} d_{1,u} F_1, d_{1,u} F_2, \dots d_{1,u} F_n \\ d_{2,u} F_1, d_{2,u} F_2, \dots d_{2,u} F_n \\ \dots \dots \dots \dots \dots \dots \\ d_{n,u} F_1, d_{n,u} F_2, \dots d_{n,u} F_n \end{array} \right|,$$

and by virtue of equations (a) the constituents of the one only differ from the corresponding constituents of the other by a negative sign, whence

$$D_x F = (-1)^n D_u F,$$

that is
$$\frac{Du}{Dx} = (-1)^n \frac{D_x F}{D_u F}.$$

Hence in the case of *implicit* connections amongst the $2n$ variables $u_1, u_2, \dots u_n; x_1, x_2, \dots x_n$, by virtue of n equations $F_1=0, F_2=0, \dots F_n=0$, connecting them,

$$\left\{ \begin{array}{l} \text{The Jacobian of } u_1, u_2, \dots u_n \\ \text{with regard to } x_1, x_2, \dots x_n \end{array} \right\} \\ = (-1)^n \frac{\left\{ \begin{array}{l} \text{Jacobian of } F_1, F_2, \dots \text{ with regard to } x_1, x_2, \dots \\ \text{treating } u_1, u_2, \dots \text{ as constants} \end{array} \right\}}{\left\{ \begin{array}{l} \text{Jacobian of } F_1, F_2, \dots \text{ with regard to } u_1, u_2, \dots \\ \text{treating } x_1, x_2, \dots \text{ as constants} \end{array} \right\}}.$$

The substance of this and the immediately preceding articles on M. Bertrand's treatment of Jacobians was communicated to the author many years ago by his former tutor, the late Dr. E. J. Routh. The reader may consult Bertrand's *Calcul Différentiel*, pages 62-70, and *Calcul Intégral*, pages 465-469.

837. Advantage of Bertrand's Definition.

It will be seen that M. Bertrand's definition leads to simpler proofs of the fundamental properties of Jacobians than those given in Arts. 540, 544 of the author's *Differential Calculus*, and retains a command of the several increments which we shall find useful for subsequent work in the transformation of a multiple integral.

838. Bertrand's Method of Calculating the Jacobian Determinant.

Let there be $2n$ variables, in two groups, viz. $x_1, x_2, \dots x_n$ and $u_1, u_2, \dots u_n$, connected by n independent implicit relations $F_1=0, F_2=0, F_3=0, \dots F_n=0$. Then n of the $2n$ variables are independent. If increments be given to each, these $2n$ increments are connected by n homogeneous linear equations, and if $n-1$ of the increments be chosen to be zero, the ratios of the remaining $n+1$ are determinate by the n connecting equations.

Consider the n incremental systems,

$$\left\{ \begin{array}{l} d_1u_1, d_1u_2, d_1u_3, \dots, d_1u_n \\ 0, d_2u_2, d_2u_3, \dots, d_2u_n \\ 0, 0, d_3u_3, \dots, d_3u_n \\ \dots\dots\dots\dots\dots\dots\dots\dots\dots\dots\dots\dots \\ 0, 0, 0, \dots d_nu_n \end{array} \right\} \left\{ \begin{array}{l} d_1x_1, 0, 0, \dots 0 \\ d_2x_1, d_2x_2, 0, \dots 0 \\ d_3x_1, d_3x_2, d_3x_3, \dots 0 \\ \dots\dots\dots\dots\dots\dots\dots\dots\dots\dots\dots\dots \\ d_nx_1, d_nx_2, d_nx_3, \dots d_nx_n \end{array} \right\},$$

that is systems in which

increments $d_1u_1, d_1u_2, \dots, d_1u_n$ give rise to an increment d_1x_1 in x_1 , but make no change in x_2, x_3, \dots, x_n ,

and increments $d_2u_2, d_2u_3, \dots, d_2u_n, d_2x_1$ give rise to a change d_2x_2 in x_2 , but make no change in $u_1, x_3, x_4, \dots, x_n$, and so on.

Let J be the Jacobian of x_1, x_2, \dots, x_n with regard to u_1, u_2, \dots, u_n . Then forming J according to Bertrand's definition, each of the determinants of the increments, the one formed from the x -increments, the other from the u -increments, reduces to its diagonal term, and

$$J = \text{Lit} \frac{d_1x_1 \cdot d_2x_2 \cdot d_3x_3 \dots d_nx_n}{d_1u_1 \cdot d_2u_2 \cdot d_3u_3 \dots d_nu_n} = \frac{\partial x_1}{\partial u_1} \cdot \frac{\partial x_2}{\partial u_2} \cdot \frac{\partial x_3}{\partial u_3} \dots \frac{\partial x_n}{\partial u_n},$$

where $\frac{\partial x_r}{\partial u_r}$ is the limit of the infinitesimal change in x_r to that in u_r when $u_1, u_2, \dots, u_{r-1}, x_{r+1}, x_{r+2} \dots x_n$ are regarded as constants.

839. It is necessary for the use of this rule to consider the several connecting equations reduced to such form that

- (1) x_1 is a function of $u_1, x_2, x_3, \dots, x_n$; u_1 only varying;
- (2) x_2 is a function of $u_1, u_2, x_3, \dots, x_n$; u_2 only varying;
- (3) x_3 is a function of $u_1, u_2, u_3, x_4, \dots, x_n$; u_3 only varying;
-
- (n) x_n is a function of $u_1, u_2, u_3, \dots, u_n$; u_n only varying.

The calculation of J will then be reduced to the multiplication of the several partial differential coefficients derived therefrom.

840. Illustrative Examples.

Ex. 1. If $x=r \cos \theta, y=r \sin \theta$, write

$$x = \sqrt{r^2 - y^2}, \text{ containing one of the new variables;}$$

$$y = r \sin \theta, \text{ containing two and no } x.$$

Then
$$J = \frac{r}{\sqrt{r^2 - y^2}} \cdot r \cos \theta = r.$$

Ex. 2. If $x=r \sin \theta \cos \phi, y=r \sin \theta \sin \phi, z=r \cos \theta$, write

$$x = \sqrt{r^2 - y^2 - z^2}, \text{ containing one of the new variables;}$$

$$z = r \cos \theta, \text{ containing two and no } x;$$

$$y = r \sin \theta \sin \phi, \text{ containing three and no } x \text{ or } z.$$

Then
$$J = \frac{\partial x}{\partial r} \cdot \frac{\partial z}{\partial \theta} \cdot \frac{\partial y}{\partial \phi} = \frac{r}{x} \cdot (-r \sin \theta) (r \sin \theta \cos \phi) = -r^2 \sin \theta.$$

Ex. 3. If $x+y+z=u$, $y+z=uv$, $z=uvw$, we have

$$x = u - y - z, \text{ containing one new variable,}$$

$$y = uv - z, \text{ containing two and no } x,$$

$$z = uvw, \text{ containing three and no } x \text{ or } y;$$

and

$$J = \frac{\partial x}{\partial u} \cdot \frac{\partial y}{\partial v} \cdot \frac{\partial z}{\partial w} = 1 \cdot u \cdot uv = u^2v.$$

Ex. 4. If $x_1 = r \sin \theta \cos \phi$, $x_2 = r \sin \theta \sin \phi$,

$$x_3 = r \cos \theta \cos \psi, \quad x_4 = r \cos \theta \sin \psi,$$

we have $x_1 = \sqrt{r^2 - x_2^2 - x_3^2 - x_4^2}$, containing r, x_2, x_3, x_4 ;

$$x_2 = \sqrt{r^2 \cos^2 \theta - x_3^2}, \quad \text{containing } r, \theta, x_4;$$

$$x_3 = r \sin \theta \sin \phi, \quad \text{containing } r, \theta, \phi;$$

$$x_4 = r \cos \theta \sin \psi, \quad \text{containing } r, \theta, \psi;$$

and

$$J = \frac{\partial x_1}{\partial r} \frac{\partial x_2}{\partial \theta} \frac{\partial x_3}{\partial \phi} \frac{\partial x_4}{\partial \psi} = \frac{r}{x_1} \cdot \frac{-r^2 \sin \theta \cos \theta}{x_2} \cdot r \sin \theta \cos \phi \cdot r \cos \theta \cos \psi \\ = -r^3 \sin \theta \cos \theta.$$

Ex. 5. If

$$x_1 = r \cos \theta_1,$$

$$x_2 = r \sin \theta_1 \cos \theta_2,$$

$$x_3 = r \sin \theta_1 \sin \theta_2 \cos \theta_3,$$

$$x_4 = r \sin \theta_1 \sin \theta_2 \sin \theta_3 \cos \theta_4,$$

$$x_5 = r \sin \theta_1 \sin \theta_2 \sin \theta_3 \sin \theta_4 \cos \theta_5,$$

$$x_6 = r \sin \theta_1 \sin \theta_2 \sin \theta_3 \sin \theta_4 \sin \theta_5,$$

we have

$$x_6 = \sqrt{r^2 - x_1^2 - x_2^2 - x_3^2 - x_4^2 - x_5^2},$$

$$x_1 = r \cos \theta_1,$$

$$x_2 = r \sin \theta_1 \cos \theta_2,$$

$$x_3 = r \sin \theta_1 \sin \theta_2 \cos \theta_3,$$

$$x_4 = r \sin \theta_1 \sin \theta_2 \sin \theta_3 \cos \theta_4,$$

$$x_5 = r \sin \theta_1 \sin \theta_2 \sin \theta_3 \sin \theta_4 \cos \theta_5;$$

and $J = \frac{r}{x_6} (-r \sin \theta_1) (-r \sin \theta_1 \sin \theta_2) (-r \sin \theta_1 \sin \theta_2 \sin \theta_3)$

$$\times (-r \sin \theta_1 \sin \theta_2 \sin \theta_3 \sin \theta_4) (-r \sin \theta_1 \sin \theta_2 \sin \theta_3 \sin \theta_4 \sin \theta_5)$$

$$= (-1)^5 r^5 \sin^4 \theta_1 \sin^3 \theta_2 \sin^2 \theta_3 \sin \theta_4 \sin \theta_5,$$

a result which can obviously be generalised.

841. Change of the Variables in any Multiple Integral. General Theorem.

Let the integral in question be

$$I = \iiint \dots \int V dx_1 dx_2 \dots dx_n,$$

there being n integration signs, and V any function of the variables x_1, x_2, \dots, x_n . Let the new system of variables be u_1, u_2, \dots, u_n , there being n independent connecting relations

$$F_1 = 0, F_2 = 0, \dots, F_n = 0,$$

between the two groups of variables, either set forming a group in which there is no interdependence. That is, the group $x_1, x_2, \dots x_n$ forms a set of n independent variables, as also does the group $u_1, u_2, \dots u_n$. When a further relation is assigned, say $\phi(x_1, x_2, \dots x_n)=0$, to be satisfied at the boundaries of the region of integration, an interdependence of the x -group is created, and one of the x -group of variables is dependent upon the others. Integration is then to be conducted for the domain or region bounded by the specific limitation $\phi=0$. There will then be a corresponding relation amongst the u -group of coordinates, and a specific limitation will be implied for the new definition of the domain of integration when I has been referred to its new coordinates.

842. In the transformation of I three separate considerations are to be attended to. As has already been pointed out in the case of double and triple integration, we have to consider

- (1) the determination of the new form of V , which is merely an algebraic matter of substitution or elimination;
- (2) the assignment of the new limits which is also an algebraic matter, materially assisted in the case of double and triple integration by geometrical considerations;
- (3) the determination of the new element of integration which is to replace $dx_1 dx_2 dx_3 \dots dx_n$.

As regards the assignment of new limits it is not possible to give a general rule, but it must be *such as will cause the march of the new element as described in the new system of variables to traverse the same domain once and once only as was traversed in the march of the original element, which domain was defined by the limits of integration in the original system of variables.*

Let us imagine that the connecting equations have been thrown into the forms

$$\begin{array}{ll}
 x_1 = f_1(u_1, x_2, x_3, \dots x_n) \dots\dots(1), & \text{i.e. } u_2, u_3, \dots u_n \text{ eliminated;} \\
 x_2 = f_2(u_1, u_2, x_3, \dots x_n) \dots\dots(2), & \text{i.e. } x_1, u_3, u_4, \dots u_n \text{ ,,} \\
 x_3 = f_3(u_1, u_2, u_3, x_4, \dots x_n) \dots(3), & \text{etc.;} \\
 & \text{etc.,} \\
 x_n = f(u_1, u_2, u_3, \dots u_n) \dots\dots(n) & \text{etc.}
 \end{array}$$

We have seen in earlier articles and examples, that in a given multiple integral the order of integration may be changed, provided a suitable change be made in the limits.

Then, first, suppose we attempt to replace integration with regard to x_1 by integration with regard to u_1 .

Change the order of integration in

$$I \equiv \iiint \dots \int V dx_1 dx_2 \dots dx_n,$$

so that dx_1 stands last with the suitable change in the limits. We then have to perform the operation

$$I \equiv \left[\iiint \dots \int V dx_2 dx_3 \dots dx_n \right] dx_1,$$

and in this operation $x_2, x_3, \dots x_n$ are to be regarded as constants, and equation (1) gives $dx_1 = \frac{\partial f_1}{\partial u_1} du_1$.

And since $\int U dx_1 = \int U \frac{\partial x_1}{\partial u_1} du_1$, we have as x_1 and u_1 are the only varying quantities

$$I := \left[\iiint \dots \int V_1 dx_2 dx_3 \dots dx_n \right] \frac{\partial f_1}{\partial u_1} du_1,$$

where V_1 is what V becomes when $f_1(u_1, x_2, x_3, \dots x_n)$ has been substituted for x_1 , that is, V_1 is the value of V expressed in terms of $u_1, x_2, x_3, \dots x_n$.

We have now arrived at

$$I = \iiint \dots \int V_1 \frac{\partial f_1}{\partial u_1} dx_2 dx_3 \dots dx_n du_1.$$

Let us repeat the process.

By change of order of integration with a suitable change in the limits, transfer dx_2 so that it stands last.

$$I = \iiint \dots \int V_1 \frac{\partial f_1}{\partial u_1} dx_3 dx_4 \dots dx_n du_1 dx_2$$

or $\left[\iiint \dots \int V_1 \frac{\partial f_1}{\partial u_1} dx_3 dx_4 \dots dx_n du_1 \right] dx_2,$

and in this operation $x_3, x_4, \dots x_n, u_1$ are to be regarded as constants, and equation (2) gives $dx_2 = \frac{\partial f_2}{\partial u_2} du_2$.

Whence again applying the theorem $\int U' dx_2 = \int U' \frac{\partial x_2}{\partial u_2} du_2$, and x_2, u_2 being the only varying quantities, we have

$$I = \iiint \dots \int V_2 \frac{\partial f_1}{\partial u_1} dx_3 dx_4 \dots dx_n du_1 \left] \frac{\partial f_2}{\partial u_2} du_2,$$

where V_2 is what V_1 becomes when $f_2(u_1, u_2, x_3, \dots x_n)$ is substituted for x_2 , that is V_2 is the value of V expressed in terms of $u_1, u_2, x_3, \dots x_n$; and we have now arrived at

$$I = \iiint \dots \int V_2 \frac{\partial f_1}{\partial u_1} \frac{\partial f_2}{\partial u_2} dx_3 dx_4 \dots dx_n du_1 du_2.$$

Continuing this process of changing the order of integration so that dx_3 is transferred to the end, and then exchanging the variable x_3 for u_3 , etc., we finally arrive at

$$I = \iiint \dots \int V_n \frac{\partial f_1}{\partial u_1} \cdot \frac{\partial f_2}{\partial u_2} \cdot \frac{\partial f_3}{\partial u_3} \dots \frac{\partial f_n}{\partial u_n} du_1 du_2 \dots du_n,$$

where V_n is the value of V when all letters of the x -group in V have been replaced by letters of the u -group, that is $V_n \equiv V'$, say.

Now it has been seen that

$$\frac{\partial f_1}{\partial u_1} \cdot \frac{\partial f_2}{\partial u_2} \cdot \frac{\partial f_3}{\partial u_3} \dots \frac{\partial f_n}{\partial u_n} \equiv J,$$

the Jacobian of $x_1, x_2, \dots x_n$ with regard to $u_1, u_2, \dots u_n$; and

$$J = (-1)^n \begin{vmatrix} \frac{\partial F_1}{\partial u_1} & \frac{\partial F_1}{\partial u_2} & \dots & \frac{\partial F_1}{\partial u_n} \\ \frac{\partial F_2}{\partial u_1} & \frac{\partial F_2}{\partial u_2} & \dots & \frac{\partial F_2}{\partial u_n} \\ \dots & \dots & \dots & \dots \\ \frac{\partial F_n}{\partial u_1} & \frac{\partial F_n}{\partial u_2} & \dots & \frac{\partial F_n}{\partial u_n} \end{vmatrix} \bigg/ \begin{vmatrix} \frac{\partial F_1}{\partial x_1} & \frac{\partial F_1}{\partial x_2} & \dots & \frac{\partial F_1}{\partial x_n} \\ \frac{\partial F_2}{\partial x_1} & \frac{\partial F_2}{\partial x_2} & \dots & \frac{\partial F_2}{\partial x_n} \\ \dots & \dots & \dots & \dots \\ \frac{\partial F_n}{\partial x_1} & \frac{\partial F_n}{\partial x_2} & \dots & \frac{\partial F_n}{\partial x_n} \end{vmatrix}$$

or
$$(-1)^n \frac{\frac{\partial(F_1, F_2, F_3, \dots F_n)}{\partial(u_1, u_2, u_3, \dots u_n)}}{\frac{\partial(F_1, F_2, F_3, \dots F_n)}{\partial(x_1, x_2, x_3, \dots x_n)}}$$

where in forming the numerator all letters of the x -group are considered constant, and in the denominator all letters of the u -group are considered constant.

Hence, we have finally,

$$\begin{aligned} & \iiint \dots \int V dx_1 dx_2 dx_3 \dots dx_n \\ &= (-1)^n \iiint \dots \int V' \frac{\frac{\partial(F_1, F_2, \dots, F_n)}{\partial(u_1, u_2, \dots, u_n)}}{\frac{\partial(F_1, F_2, \dots, F_n)}{\partial(x_1, x_2, \dots, x_n)}} du_1 du_2 du_3 \dots du_n. \end{aligned}$$

843. Ex. If $\left. \begin{array}{l} xu + yv = a^2, \\ xv - yu = 0, \end{array} \right\}$ be the connecting equations,

$$J = \frac{\begin{vmatrix} x & y \\ -y & x \\ u & v \\ v & -u \end{vmatrix}}{\begin{vmatrix} x & y \\ u & v \end{vmatrix}} = -\frac{x^2 + y^2}{u^2 + v^2} = -\frac{a^4}{(u^2 + v^2)^2}.$$

Compare the process of Ex. 8, Art. 831.

844. The Vanishing of J .

It may be noted that the vanishing of J would imply that when x_1, x_2, \dots, x_n are regarded as functions of u_1, u_2, u_3, \dots , there would be some identical relation amongst the members of the x -group of variables; and if J were infinite, we should have $J' = 0$, and there would be some identical relation amongst the values of u_1, u_2, \dots, u_n as expressed in terms of x_1, x_2, \dots, x_n , (Art. 547, *Differential Calculus*). We have, however, assumed all our several connecting equations $F_1 = 0, F_2 = 0, \dots, F_n = 0$, to be independent relations, so that no such identical relation can occur amongst either set of variables.

845. Remarks.

It may be useful to call attention to the fact that in the geometrical treatment of Arts. 792 and 794 for double and triple integrals respectively, the new element of integration was formed and the variables were changed to the new group *all together*. In the general proof of Art. 842, the original variables were exchanged for the new variables *one at a time*. When a geometrical method of determining the new limits is not available, this consideration will often be useful for their proper assignment, and may be used when other means are wanting. But the process followed out in detail is generally tedious, as every change in order of an integration

as well as every exchange of a new variable for an old one necessitates in general a readjustment of the limits of each integration.

846. Examples in which Multiple Integrals of Order higher than the Third occur in Physics.

Multiple integrals occur frequently in researches of physical nature, of higher degree of multiplicity than the third. For instance, in the problem of the illumination of one surface by another, the two surfaces being such that every point of the one can be seen from each point of the other, the quantity to be evaluated is the quadruple integral *

$$\iiint\int \frac{\cos \phi \cos \phi'}{r^2} dS dS',$$

where dS, dS' are the elements of the two surfaces; ϕ, ϕ' the angles which the outward normals make with r , the distance between dS and dS' , and the integration is to be conducted over each surface. In such case, the limits form two separate groups, the one referring to surface S , the other to surface S' , and if any transformation of variables be required, a new assignment of limits being required, they will be available from geometrical conditions for each group.

Another illustration from Physics is in the mutual potential of two attracting systems, which for a continuous distribution of matter in regions P, Q has for its expression the sextuple integral

$$W_{PQ} \equiv \iiint\iiint\int \frac{\rho_p \rho_q}{r_{pq}} d\tau_p d\tau_q,$$

where ρ_p is the volume density at a point p of the region P ;
 ρ_q the volume density at a point q of the region Q ;
 $d\tau_p, d\tau_q$ elements of volume at p and q , and r_{pq} the distance from p to q .

In this case also the system of limits will be two separate systems, the one ensuring summation through the region P and the other through the region Q . And if any change of variable be required to facilitate integration, necessitating a new assignment of limits, they will be available as in the former case from the geometrical conditions for each group.

* See Herman, *Geometrical Optics*, Art. 157.

847. Case of Implicit Relations.

If in Art. 839 Equations (1), (2), ... (n) had not been supposed to express

- x_1 explicitly as a function of $u_1, x_2, x_3, \dots x_n,$
- x_2 explicitly as a function of $u_1, u_2, x_3, \dots x_n,$
- etc.,

but had been given as implicit relations, viz.

$$\phi_1(u_1, x_1, x_2, \dots x_n) = 0 \dots (1), \text{ in which } u_2, u_3, \dots u_n \text{ are eliminated,}$$

$$\phi_2(u_1, u_2, x_2, x_3, \dots x_n) = 0 \dots (2), \text{ in which } x_1, u_3, \dots u_n \text{ are eliminated,}$$

$$\phi_3(u_1, u_2, u_3, x_3, \dots x_n) = 0 \dots (3), \quad \text{etc.,}$$

etc.,

$$\phi_n(u_1, u_2, u_3, \dots u_n, x_n) = 0 \dots (n) \quad \text{etc.,}$$

we have in the subsequent work, from equation (1), considering $x_2, x_3, \dots x_n$ as constants,

$$dx_1 = - \frac{\frac{\partial \phi_1}{\partial u_1}}{\frac{\partial \phi_1}{\partial x_1}} du_1 ;$$

and from equation (2), considering $u_1, x_3, x_4, \dots x_n$ as constants,

$$dx_2 = - \frac{\frac{\partial \phi_2}{\partial u_2}}{\frac{\partial \phi_2}{\partial x_2}} du_2,$$

and so on.

And we finally obtain in the same way as before,

$$\begin{aligned} & \iint \dots \int V dx_1 dx_2 \dots dx_n \\ &= (-1)^n \iint \dots \int V' \frac{\frac{\partial \phi_1}{\partial u_1} \cdot \frac{\partial \phi_2}{\partial u_2} \cdot \frac{\partial \phi_3}{\partial u_3} \dots \frac{\partial \phi_n}{\partial u_n}}{\frac{\partial \phi_1}{\partial x_1} \cdot \frac{\partial \phi_2}{\partial x_2} \cdot \frac{\partial \phi_3}{\partial x_3} \dots \frac{\partial \phi_n}{\partial x_n}} du_1 du_2 \dots du_n. \end{aligned}$$

848. For example, taking

- $\phi_1 \equiv r^2 - x^2 - y^2 - z^2 = 0$ (containing $z, y, x, r,$)
- $\phi_2 \equiv r^2 \sin^2 \theta - x^2 - y^2 = 0$ (containing $y, x, r, \theta,$)
- $\phi_3 \equiv r \sin \theta \cos \phi - x = 0$ (containing $x, r, \theta, \phi.$)

Then we have

$$\begin{aligned} \iiint V dx dy dz &= - \iiint V' \frac{\frac{\partial \phi_1}{\partial r} \cdot \frac{\partial \phi_2}{\partial \theta} \cdot \frac{\partial \phi_3}{\partial \phi}}{\frac{\partial \phi_1}{\partial z} \cdot \frac{\partial \phi_2}{\partial y} \cdot \frac{\partial \phi_3}{\partial x}} dr d\theta d\phi \\ &= - \iiint V' \frac{2r \cdot 2r^2 \sin \theta \cos \theta (-r \sin \theta \sin \phi)}{(-2z)(-2y)(-1)} dr d\theta d\phi \\ &= - \iiint V' \frac{r^4 \sin^2 \theta \cos \theta \sin \phi}{r \sin \theta \sin \phi \cdot r \cos \theta} dr d\theta d\phi \\ &= - \iiint V' r^2 \sin \theta dr d\theta d\phi, \end{aligned}$$

as we should expect; see Ex. 2, Art. 840, and elsewhere.

849. Example of Assignment of Limits.

Ex. As an example of the assignment of limits in a multiple integral, let us take two squares of sides $2a$ in parallel planes at distance c apart, the squares being placed so that they form the ends of a rectangular parallelepiped of square section, and let us find the mean value of the squares of the distances of points on the one square from points on the other. By a mean or average value we shall suppose to be meant that each square is divided up into equal small elements, and the sum of the squares of the distances apart is to be divided by their number, *i.e.* if there be n such elements, and r_{PQ} be the distance between two of them at P and at Q respectively, $\frac{\sum r_{PQ}^2}{n}$, or, which is the same thing, $\frac{\sum r_{PQ}^2 \delta S_P \delta S_Q}{\sum \delta S_P \delta S_Q}$ if δS_P and δS_Q be the elements at P and Q ; and in the limit, when n becomes infinitely large, we have

$$\frac{\iiint \iiint r_{PQ}^2 dS_P dS_Q}{\iiint \iiint dS_P dS_Q}. \quad (\text{See Chapter XXXVI., Art. 1657.})$$

Let O, O' be the centres of the squares, and take O for origin and axes of x and y parallel to the sides of the squares.

Divide up each square by families of lines parallel to the axes, and let $(x, y, 0), (x', y', c)$ be the respective coordinates of P and Q . Then the Mean Value required is

$$M = \frac{\iiint \iiint [(x-x')^2 + (y-y')^2 + c^2] dx' dy' dx dy}{\iiint \iiint dx' dy' dx dy}.$$

Now keeping the position of Q fixed, we may add up all the elements $r_{PQ}^2 \delta x \delta y$ in a strip between x and $x + \delta x$, by varying y from $-a$ to $+a$, keeping x', y', x constant. Then, still keeping x', y' constants, we may add up all the strips in the square $ABCD$ which lies in the $x-y$ plane, by integrating with regard to x from $x = -a$ to $x = +a$. We have then completed the summation of all such quantities as $r_{PQ}^2 dx' dy'$ for all

positions of P in the square $ABCD$. In the same way we may add up the results of these integrations for various points of the square $A'B'C'D'$, by integrating with regard to y' from $-a$ to $+a$, keeping x' constant to add up the elements in a strip between x' and $x'+\delta x'$. And finally integrating with regard to x' from $-a$ to $+a$ will add up the results for all the strips in the square $A'B'C'D'$ and will complete the integration.

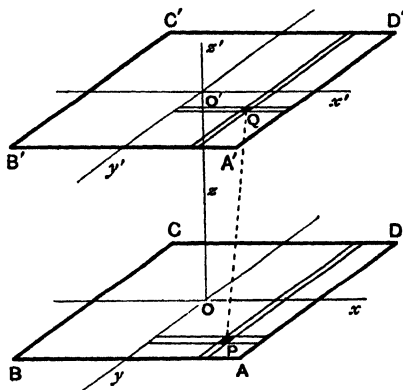

Fig. 312.

And the same with the denominator. The result for the denominator is obviously the product of the two areas, *i.e.* $4a^2 \times 4a^2$ or $16a^4$.

The numerator is

$$\iiint \int (x^2 + y^2 + x'^2 + y'^2 - 2xx' - 2yy' + c^2) dx' dy' dx dy,$$

and it will save some trouble to observe :

- (1) That for every term $xx' \delta x' \delta y' \delta x \delta y$, there is another term $x(-x') \delta x' \delta y' \delta x \delta y$.

Hence such a term contributes nothing to the value of the integral, and the same with the yy' term.

- (2) That obviously

$$\Sigma x^2 dS dS' = \Sigma y^2 dS dS' = \Sigma x'^2 dS dS' = \Sigma y'^2 dS dS'.$$

Hence it will be sufficient to attend to the value of one of them, and quadruple the result.

Now

$$\begin{aligned} \int_{-a}^a \int_{-a}^a \int_{-a}^a \int_{-a}^a x^2 dx' dy' dx dy &= \int_{-a}^a \int_{-a}^a \int_{-a}^a 2ax^2 dx' dy' dx \\ &= \int_{-a}^a \int_{-a}^a (2a) \left(\frac{2a^3}{3} \right) dx' dy' = (2a)^3 \cdot \frac{2a^3}{3}. \end{aligned}$$

Hence the value of the numerator is

$$4 \left(\frac{8}{3} a^6 \right) + c^2 \cdot 16a^4,$$

and

$$M = \frac{4a^2 + 3c^2}{3}.$$

It follows that the mean of the squares of the distances from any point of a square to any other point of the same square is $\frac{4a^2}{3}$, by putting $c=0$. [Also see Art. 1657 and Art. 1658, Ex. 2.]

850. A Consideration useful for the Simplification of some Transformation Formulae.

Let a multiple integral $\iiint \dots \int V du_1 du_2 \dots du_n$ be transformed in two ways :

- (1) to a set of variables $x_1, x_2, \dots x_n$;
- (2) to a set of variables $\xi_1, \xi_2, \dots \xi_n$.

And suppose these two sets are *linearly* connected with each other, the transformation formulae for the linear connections being given by the transformation scheme in the margin. And let the two results be

	ξ_1	ξ_2	ξ_3	\dots
x_1	l_1	m_1	n_1	\dots
x_2	l_2	m_2	n_2	\dots
x_3	l_3	m_3	n_3	\dots
\dots	\dots	\dots	\dots	\dots

$\iint \dots \int V_1 J_1 dx_1 dx_2 \dots dx_n$
 and $\iint \dots \int V_2 J_2 d\xi_1 d\xi_2 \dots d\xi_n$.

Then, the Jacobian is a covariant of $u_1, u_2, \dots u_n$; we have

$$J_2 = J_1 \begin{vmatrix} l_1, & l_2, & \dots \\ m_1, & m_2, & \dots \\ \dots & \dots & \dots \end{vmatrix} = \mu J_1 \quad (\text{Diff. Calc., Art. 546}),$$

μ being the transformation modulus. And that the above expressions are equal may be seen by transforming directly, for

$$\begin{aligned} & \iint \dots \int V_1 J_1 dx_1 dx_2 \dots dx_n \\ &= \iint \dots \int V_2 J_1 \frac{\partial(x_1, x_2, \dots x_n)}{\partial(\xi_1, \xi_2, \dots \xi_n)} d\xi_1 d\xi_2 \dots d\xi_n \\ &= \iint \dots \int V_2 J_1 \mu d\xi_1 d\xi_2 \dots d\xi_n \\ &= \iint \dots \int V_2 J_2 d\xi_1 d\xi_2 \dots d\xi_n, \end{aligned}$$

and the results are identical, as might have been expected.

It follows that if a transformation be proposed to a set of variables $\xi_1, \xi_2, \xi_3, \dots$, a transformation to another set

x_1, x_2, x_3, \dots may be substituted for the former, where a suitable choice of linear connection between the former and the latter sets may sometimes be made to simplify the working.

851. For example, if the transformation formulae proposed be

$$u_1 = (A\xi + B\eta) \sin (C\xi + D\eta),$$

$$u_2 = (A\xi + B\eta) \cos (C\xi + D\eta),$$

we shall have the same result as if we transform with the easier formulae

$$\left. \begin{aligned} u_1 &= x \sin y, \\ u_2 &= x \cos y, \end{aligned} \right\}$$

for which the Jacobian is obviously $-x$, and multiply the result by the modulus $AD - BC$.

$$\begin{aligned} \text{Thus} \quad \iint V du_1 du_2 &= - \iint V_1 x dx dy \\ &= -(AD - BC) \iint V_2 (A\xi + B\eta) d\xi d\eta, \end{aligned}$$

thus avoiding the more troublesome evaluation of the Jacobian with regard to ξ, η .

852. Speaking of the result

$$\iiint V dx dy dz = \iiint V' \frac{\partial(x, y, z)}{\partial(u, v, w)} du dv dw,$$

Lacroix* remarks: "Ce resultat a été donnée pour la première fois par Lagrange en 1773. Mais Legendre, en 1788, en a fait des applications que Lagrange n'avoit point indiquées." This application referred in part to the analytical proof of a theorem with regard to the attraction of a spheroid.

The corresponding result for a double integral had been employed by Euler in 1769.

Many references with regard to the history of the subject are given by Todhunter, *Integral Calculus*, Art. 251. There is a valuable table of references in Lacroix's *Calc. Diff. et Int.*, vol. ii., prefixed to the volume, which may be useful to students interested in the subject and desiring to consult early writers.

* Lacroix, *Calcul. Diff. et Int.*, vol. ii., p. 206.

PROBLEMS.

1. If the rectangular coordinates of a point are

$$x = \alpha + e^{\beta} \cos \alpha, \quad y = \beta + e^{\beta} \sin \alpha,$$

show that the area included between the curves $\alpha_1, \beta_1, \alpha_2, \beta_2$ is

$$\frac{1}{2} (\alpha_1 - \alpha_2) (2\beta_1 - e^{2\beta_1} - 2\beta_2 + e^{2\beta_2}).$$

[MATH. TRIP., 1873.]

2. Integrate $\iint x^2 dx dy$ over the space enclosed by the four parabolas $y^2 = 4ax, y^2 = 4bx, x^2 = 4cy, x^2 = 4dy$.

[TRINITY COLL., 1882.]

3. The four curves $y = ax^2, y = bx^2, y = cx^3, y = dx^3$ intersect in four points, excluding the origin, and thus form a curvilinear quadrilateral; prove that its area is

$$\frac{1}{12} (a^4 \sim b^4) \left(\frac{1}{c^3} \sim \frac{1}{d^3} \right).$$

[OXFORD II. P., 1901.]

4. An area is bounded by those portions of the four rectangular hyperbolae $xy = a^2, xy = a'^2, x^2 - y^2 = c^2, x^2 - y^2 = c'^2$, which lie in the first quadrant. Every element of the area is multiplied by the square of its distance from the centre. Prove that the sum of all such products is

$$\frac{1}{2} (a^2 \sim a'^2) (c^2 \sim c'^2). \quad [\text{J. M. SCH., OXF., 1904.}]$$

5. If the surface density σ of the area in the first quadrant bounded by

$$x^m y^n = a_1^{m+n}, \quad x^p y^q = b_1^{p+q},$$

$$x^m y^n = a_2^{m+n}, \quad x^p y^q = b_2^{p+q},$$

be given by $\sigma xy = k$, show that the mass is

$$k \frac{(m+n)(p+q)}{mq - np} \log \frac{a_1}{a_2} \cdot \log \frac{b_1}{b_2}.$$

6. Change the variables from x and y to u and v in the double integral

$$\int_0^a \int_x^{\frac{a^2}{x}} \phi(x, y) dx dy,$$

where $xy = u^2, x^2 + y^2 = v^2$.

[ST. JOHN'S, 1882.]

7. Show that in $\int_{-a}^a \int_{-b}^b f(x, y) dx dy$ all terms in $f(x, y)$ may be omitted which contain an odd power of x or y .

$$\text{Find } \int_0^a \int_{-x}^x (x+y) \cos(mx + ny) dx dy.$$

[TRINITY COLL., 1881.]

8. Transform $\int_0^\infty \int_0^{\sqrt{2ax}} \frac{a^2 dx dy}{(x^2 + y^2 + a^2)^2}$ by the substitution

$$x/\xi = y, \quad \eta = \sqrt{x^2 + y^2 + a^2}/a,$$

and show that its value is $\pi/4\sqrt{2}$.

[OXFORD II. P., 1903.]

9. Change the order of integration in

$$\int_0^{\frac{a}{2}} \int_{\frac{x^2}{a}}^{x - \frac{x^2}{a}} V \, dx \, dy.$$

[ST. JOHN'S, 1889.]

10. If $xy = \xi$, $x^2 - y^2 = \eta$ transform $\int_0^1 \int_0^1 V \, dx \, dy$ so that in the result we integrate first with regard to ξ and then with regard to η .

[R. P.]

11. Change the order of integration in the expression

$$\int_0^c \sqrt{k} \int_k^h \frac{c^2 + x^2}{c^2 + x^4} V \, dx \, dy;$$

also, change the variables to ξ and η where $x^2 + y^2 = \eta$, $\xi x = cy$, without assigning the new limits. (It may be assumed that k is greater than h .)

[ST. JOHN'S, 1888.]

12. Prove that

$$\iint \left(\frac{1 - \frac{x^2}{a^2} - \frac{y^2}{b^2}}{1 + \frac{x^2}{a^2} + \frac{y^2}{b^2}} \right)^{\frac{1}{2}} dx \, dy = \frac{\pi}{4} \left(\frac{\pi}{2} - 1 \right) ab,$$

the integral being taken for all positive values of x and y such that

$$\frac{x^2}{a^2} + \frac{y^2}{b^2} < 1.$$

[COLLEGES, 1886.]

13 Express $\iint f(x, y) \, dx \, dy$ in terms of r and θ , where $x = r \cos \theta$, $y = r \sin \theta$.

Change the order of integration in

$$\int_0^a \int_{\sqrt{ax-x^2}}^{\sqrt{ax}} f(x, y) \, dx \, dy.$$

[COLLEGES a, 1883.]

14. Change the order of integration in

$$\int_0^{\frac{ab}{\sqrt{a^2+b^2}}} \int_0^{\frac{a}{b} \sqrt{b^2 - y^2}} f(x, y) \, dy \, dx.$$

[ST. JOHN'S, 1892.]

15. Change the order of integration in

$$\int_0^{\frac{\pi}{2}} \int_{a \sec^2 \frac{\theta}{2}}^{a \cos \theta} f(r, \theta) \, d\theta \, dr.$$

16. Change the variables from x, y to u, v , where $x^2 + y^2 = u$, $xy = v$, and find the limits in the new integral when integration is extended over the positive quadrant of the circle $x^2 + y^2 = a^2$.

[ST. JOHN'S, 1881.]

17. Change the order of integration in the integral

$$\int_c^a \int_a^b \sqrt{a^2 - x^2} V dx dy,$$

where c is less than a .

[COLLEGES α , 1888.]

18. Change the order of integration in

$$\int_0^a \int_{\frac{1}{2}\sqrt{a^2-x^2}}^{\sqrt{a^2-x^2}} U dx dy,$$

U being a function of x and y .

Express the same integral in polar coordinates. [COLLEGES α , 1886.]

19. Show that

$$\int_0^{2a} \int_{\sqrt{2ax-x^2}}^{\sqrt{2ax}} V dx dy = \int_a^{2a} \int_{\eta-a}^a \frac{2x}{y} V d\eta d\xi,$$

when

$$\xi = \frac{y^2}{2x}, \quad \eta = \frac{x^2 + y^2}{2x};$$

and change the order of integration in the latter integral.

[COLLEGES β , 1889.]

20. If the density of a plate be $\frac{\mu}{x^2 + y^2}$, show that the mass of the part enclosed by the curves $x^2 - y^2 = \alpha$, $x^2 - y^2 = \beta$, $xy = \gamma$, $xy = \delta$ is

$$\frac{\mu}{2} \int_{\alpha}^{\beta} \int_{\gamma}^{\delta} \frac{du dv}{u^2 + 4v^2}.$$

Show whether this gives the mass of one of the areas between the two curves, or of both.

[COLLEGES α , 1883.]

21. Change the variables from (x, y) to (u, v) in the double integral $\iint \phi(x, y) dx dy$, where $x^2 + y^2 = u$, $xy = v$, and the integration extends over the area bounded by the straight lines

$$y = x, \quad x + y = 1, \quad y = 0,$$

obtaining the new limits on the supposition that the order of integration is first u and then v .

[COLLEGES α , 1870.]

Verify your result by evaluation of the integral for the case when $\phi(x, y) \equiv 1$.

22. Change the variables from x and y to ξ and η in the expression $\iint V dx dy$, having given $\phi(x, y, \xi, \eta) = 0$ and $\psi(x, y, \xi, \eta) = 0$.

Show, by transforming to polar coordinates, that

$$c \int_0^{\frac{c}{\sqrt{2}} \tan \alpha} \int_0^{\frac{c}{\sqrt{2}} \tan \alpha} \frac{dx dy}{(x^2 + y^2 + c^2)^{\frac{3}{2}}} = \tan^{-1} \frac{\sec \alpha - \cos \alpha}{2}.$$

[TRINITY, 1882.]

23. If r, r' be the distances of a point in the plane of reference from two fixed points at a distance $2c$ apart on the axis of x , then between corresponding limits of integration

$$\iint 2cy \, dx \, dy = \iint rr' \, dr \, dr'. \quad [\text{OXFORD II., 1886.}]$$

24. Prove that

$$\int_0^l dx \int_0^x dy F(x, y) = \int_0^l dx \int_0^x dy F(l - y, l - x),$$

and hence deduce that

$$\int_0^\pi d\theta \int_0^\theta d\theta' (\sin \theta \sin \theta')^{2t-1} \sin(\theta - \theta') = \frac{1 \cdot 3 \cdot 5 \dots (4t-1)}{2 \cdot 4 \cdot 6 \dots 4t} \cdot \frac{\pi}{t}. \quad [\text{SYLVESTER.}]$$

25. Prove that

$$\int_0^x dx \int_0^x dz f'(z) \phi(x-z) = \int_0^x dz \{f(z) - f(0)\} \phi(x-z). \quad [\text{ST. JOHN'S, 1885.}]$$

26. Transform the integral $\int V \, dx \, dy$ by the substitution

$$x = c \cos \xi \cosh \eta, \quad y = c \sin \xi \sinh \eta. \quad [\text{COLLEGES } \gamma, 1890.]$$

27. If $u + v\sqrt{-1} = \phi(x + y\sqrt{-1})$, prove that

$$\iint \left[\left(\frac{\partial V'}{\partial x} \right)^2 + \left(\frac{\partial V'}{\partial y} \right)^2 \right] dx \, dy = \iint \left[\left(\frac{\partial V'}{\partial u} \right)^2 + \left(\frac{\partial V'}{\partial v} \right)^2 \right] du \, dv,$$

when V' is the result of substituting for x, y in terms of u, v in V .
[COLLEGES α , 1881.]

28. If $x = a \sin \alpha \cos \xi \cosh \eta$ and $y = a \sin \alpha \sin \xi \sinh \eta$, transform

$$\int_0^a \int_0^{\cos \alpha \sqrt{a^2 - x^2}} \{(x - a \sin \alpha)^2 + y^2\}^{-\frac{1}{2}} dx \, dy$$

into an integral in terms of ξ and η , and evaluate the new integral.

29. If $\frac{x^2}{a^2} + \frac{y^2}{b^2} + \frac{z^2}{c^2} = 1$ and $S = \iint dx \, dy \sqrt{1 + p^2 + q^2}$, transform the variables in the integral to θ, ϕ , where

$$x = a \sin \theta \cos \phi, \quad y = b \sin \theta \sin \phi. \quad [\text{IVORY, Phil. Trans., 1809.}]$$

30. Prove that the assumptions

$$x_1 = r \cos \theta_1, \\ x_2 = r \sin \theta_1 \cos \theta_2,$$

$$x_{n-1} = r \sin \theta_1 \sin \theta_2 \dots \sin \theta_{n-2} \cos \theta_{n-1}, \\ x_n = r \sin \theta_1 \sin \theta_2 \dots \sin \theta_{n-2} \sin \theta_{n-1},$$

will transform the integral $\iiint \dots V dx_1 dx_2 dx_3 \dots dx_n$ into

$$\pm \iiint \dots V' r^{n-1} \sin^{n-2} \theta_1 \sin^{n-3} \theta_2 \dots \sin \theta_{n-2} dr d\theta_1 \dots d\theta_{n-1}.$$

[CLARE, ETC., 1881; TODHUNTER, *Int. Calc.*, p. 241.]

31. Show that

$$48 \iiint (x^2 + y^2 + z^2) dx dy dz = 5\pi a^5$$

for positive values of x, y, z limited by $x^2 + y^2 < az$ and $\gt a^2$.

[OXFORD II. P., 1889.]

32. Prove that

$$\int_0^\infty \int_0^\infty \int_0^\infty \frac{(x^2 + y^2 + z^2)^{\frac{m}{2}}}{(x^2 + y^2 + z^2 + a^2)^{\frac{m+5}{2}}} dx dy dz = \frac{\pi}{2(m+3)} \cdot \frac{1}{a^2}.$$

[COLLEGES γ , 1882.]

33. Two given rectangular hyperbolae have the same asymptotes; two other given rectangular hyperbolae have also common asymptotes, one of which coincides with an asymptote of the first pair, while the other is parallel to their other asymptote. Show that the area of the curvilinear quadrangle formed by the four hyperbolae is the same, whatever the distance between the pair of parallel asymptotes.

[MATH. TRIPOS, 1895.]

34. Transform the double integral

$$\iint x^{m-1} y^{n-1} dy dx$$

by the formulae $x+y=u, y=uv$, showing that the transformed result is

$$\iint u^{m+n-1} (1-v)^{m-1} v^{n-1} du dv.$$

[JACOBI, *Crelle's Journal*, tom. xi.]

35. If

$$u_1 x = u_2 u_3, \quad u_2 y = u_3 u_1, \quad u_3 z = u_1 u_2,$$

prove that

$$\iiint V dx dy dz$$

is transformed into

$$4 \iiint V_1 du_1 du_2 du_3.$$

[OXFORD II. P., 1885.]

36. Show that

$$\int_a^{a\sqrt{2}} dx \int_0^{\sqrt{2a^2-x^2}} \frac{dy}{(x^2+y^2)^{\frac{3}{2}}} = \left(1 - \frac{\pi}{4}\right) \frac{1}{a\sqrt{2}},$$

and both from geometrical considerations and by direct evaluation, show that this integral is equal to the integral

$$\int_0^a dy \int_a^{\sqrt{2a^2-y^2}} \frac{dx}{(x^2+y^2)^{\frac{3}{2}}}.$$

[OXFORD I. P., 1912.]

CHAPTER XXIV.

EULERIAN INTEGRALS, GAUSS' II FUNCTION, ETC.

853. The Original Forms of the Eulerian Integrals.

The properties of the two important integrals

$$I_1 \equiv \left(\frac{p}{q}\right) \equiv \int_0^1 \frac{x^{p-1} dx}{(1-x^n)^{\frac{n-q}{n}}} \quad \text{and} \quad I_2 \equiv \left[\frac{p}{q}\right] \equiv \int_0^1 \left(\log \frac{1}{x}\right)^{p-1} dx$$

were the subject of several remarkable memoirs by Euler. His investigations were published in the *Institutiones Calculi Integralis*, 1768-1770, and are of great importance in the general theory of Definite Integrals. The notation above, viz.

$\left(\frac{p}{q}\right)$ and $\left[\frac{p}{q}\right]$, is that used by Euler, and the above forms are those in which the integrals were studied both by Euler and Lagrange. In each of these the value of the integral was supposed to change by the variation of p and q ; the n which occurs in the first integral was supposed to be a constant.

Legendre, for the purpose of characterising these integrals and honouring their great discoverer, named them "Intégrales Eulériennes."* The second part of Legendre's *Exercices de Calcul Intégral* is devoted to a discussion of their properties.

He adheres to the notation $\left(\frac{p}{q}\right)$ for the first integral, but suggests the notation $\Gamma\left(\frac{p}{q}\right)$ for the second, regarding $\Gamma(a)$ as a continuous function of a .

* *Exercices de Calcul Intégral*, par A. M. Legendre, 1811, p. 211.

854. The More Convenient Modern Forms.

The above forms of the integrals are not the most convenient in practice. Taking the first integral, write $x^n=y$, and put $p=nl$, $q=nm$.

Then

$$I_1 = \int_0^1 \frac{x^{p-1} dx}{(1-x^n)^q} = \int_0^1 \frac{y^{\frac{p-1}{n}} \cdot \frac{1}{n} y^{\frac{1}{n}} dy}{(1-y)^{\frac{q}{n}}} = \frac{1}{n} \int_0^1 y^{l-1} (1-y)^{m-1} dy.$$

Taking the second integral and writing $\log \frac{1}{x} = y$, that is $x = e^{-y}$, and putting $\frac{p}{q} = n$,

$$I_2 = \int_0^1 \left(\log \frac{1}{x} \right)^{\frac{p}{q}-1} dx = \int_0^\infty e^{-y} y^{n-1} dy.$$

855. Definition.

We shall therefore define the FIRST AND SECOND EULERIAN INTEGRALS AS

$$B(l, m) = \int_0^1 x^{l-1} (1-x)^{m-1} dx$$

and

$$\Gamma(n) \equiv \int_0^\infty e^{-x} x^{n-1} dx,$$

and refer to them respectively as the BETA and GAMMA Functions. This is now the commonly accepted notation and nomenclature.

856. In Gregory's *Examples* (p. 470), the digamma $F(l, m)$ is used to denote what we have above defined as the Beta function. It will be observed that $B(l, m)$ is n times the integral discussed by Euler, that is $n \binom{p}{q}$.

We shall assume in our subsequent work that all the quantities l, m, n are positive but not necessarily integral, and further that they are real unless the contrary be expressly stated.

857. The Beta Function is symmetric in l and m , that is,

$$B(l, m) = B(m, l).$$

If in the Beta function

$$B(l, m) \equiv \int_0^1 x^{l-1} (1-x)^{m-1} dx$$

we write $1-y$ for x , we obtain

$$\begin{aligned} B(l, m) &= - \int_1^0 (1-y)^{l-1} y^{m-1} dy = \int_0^1 y^{m-1} (1-y)^{l-1} dy \\ &= \int_0^1 x^{m-1} (1-x)^{l-1} dx = B(m, l), \end{aligned}$$

whence it appears that $B(l, m)$ is a symmetric function of l and m , the l and m being interchangeable and

$$B(l, m) \equiv B(m, l)$$

This property might be exhibited by writing $B(l, m)$ as

$$B(l, m) = \frac{1}{2} \int_0^1 [x^{l-1} (1-x)^{m-1} + x^{m-1} (1-x)^{l-1}] dx$$

858. Case when l or m is a Positive Integer.

When either of the two quantities l, m is a positive integer, the integration is expressible in finite terms

Suppose m is a positive integer,

$$B(l, m) = \int_0^1 x^{l-1} (1-x)^{m-1} dx,$$

and by continued integration by parts

$$\begin{aligned} &= \left[\frac{x^l}{l} (1-x)^{m-1} + \frac{x^{l+1}}{l(l+1)} (m-1)(1-x)^{m-2} \right. \\ &\quad + \frac{x^{l+2}}{l(l+1)(l+2)} (m-1)(m-2)(1-x)^{m-3} + \dots \\ &\quad \left. + \frac{x^{l+m-1}}{l(l+1) \dots (l+m-1)} (m-1)(m-2) \dots 2 \cdot 1 \right]_0^1 \\ &= \frac{(m-1)!}{l(l+1) \dots (l+m-1)}. \end{aligned}$$

Similarly, if l be a positive integer,

$$B(l, m) = \frac{(l-1)!}{m(m+1) \dots (m+l-1)},$$

and if both be positive integers,

$$B(l, m) = \frac{(l-1)!(m-1)!}{(l+m-1)!}.$$

859. Various Forms of the Beta Function.

The Beta function may be thrown into many other forms by a change of the variable, and therefore many other integrals are expressible in terms of the Beta function.

Thus: (1) Let $y = \frac{x}{a}$.

$$\begin{aligned} \text{Then } B(l, m) &= \int_0^1 y^{l-1}(1-y)^{m-1} dy \\ &= \int_0^a \left(\frac{x}{a}\right)^{l-1} \left(1 - \frac{x}{a}\right)^{m-1} \frac{1}{a} dx \\ &= \frac{1}{a^{l+m-1}} \int_0^a x^{l-1}(a-x)^{m-1} dx. \end{aligned}$$

$$\text{Hence } \int_0^a x^{l-1}(a-x)^{m-1} dx = a^{l+m-1} B(l, m).$$

(2) Let $y = \frac{1}{1+x}$.

$$\begin{aligned} \text{Then } B(l, m) &\equiv \int_0^1 y^{l-1}(1-y)^{m-1} dy \\ &= \int_{\infty}^0 \frac{1}{(1+x)^{l-1}} \left(\frac{x}{1+x}\right)^{m-1} (-1) \frac{dx}{(1+x)^2} \\ &= \int_0^{\infty} \frac{x^{m-1}}{(1+x)^{l+m}} dx, \end{aligned}$$

and since l, m are interchangeable this must also

$$= \int_0^{\infty} \frac{x^{l-1}}{(1+x)^{l+m}} dx,$$

which would have appeared immediately if we had made the substitution $y = \frac{x}{1+x}$ instead of $y = \frac{1}{1+x}$.

Note also that the symmetry in l, m may be exhibited as

$$B(l, m) \equiv \frac{1}{2} \int_0^1 \frac{x^{l-1} + x^{m-1}}{(1+x)^{l+m}} dx;$$

whilst for all positive values of l and m we have

$$\int_0^1 \frac{x^{l-1} - x^{m-1}}{(1+x)^{l+m}} dx = 0.$$

So that, for instance,

$$\int_0^1 \frac{x^8(1-x^8)}{(1+x)^{18}} dx = 0; \quad \text{and} \quad \int_0^1 \frac{x^8(1+x^8)}{(1+x)^{18}} dx = 2B(6, 12).$$

$$(3) \text{ Putting } \frac{y}{1+a} = \frac{x}{x+a}, \quad dy = a(a+1) \frac{dx}{(x+a)^2},$$

$$\begin{aligned} B(l, m) &= \int_0^1 y^{l-1}(1-y)^{m-1} dy \\ &= \int_0^1 (1+a)^{l-1} \left(\frac{x}{x+a}\right)^{l-1} a^{m-1} \left(\frac{1-x}{x+a}\right)^{m-1} a(a+1) \frac{dx}{(x+a)^2} \\ &= a^m (1+a)^l \int_0^1 \frac{x^{l-1}(1-x)^{m-1}}{(a+x)^{l+m}} dx. \end{aligned}$$

$$\text{Hence} \quad \int_0^1 \frac{x^{l-1}(1-x)^{m-1}}{(a+x)^{l+m}} dx = \frac{B(l, m)}{a^m(1+a)^l}.$$

This is **Abel's transformation** (*Œuvres*, Vol. I., p. 93).

$$(4) \text{ Put} \quad y = \frac{x-b}{a-b}.$$

$$\begin{aligned} \text{Then} \quad B(l, m) &\equiv \int_0^1 y^{l-1}(1-y)^{m-1} dy \\ &= \int_b^a \left(\frac{x-b}{a-b}\right)^{l-1} \left(\frac{a-x}{a-b}\right)^{m-1} \frac{dx}{a-b} \\ &= \frac{1}{(a-b)^{l+m-1}} \int_b^a (x-b)^{l-1}(a-x)^{m-1} dx, \end{aligned}$$

$$\text{and} \quad \int_b^a (x-b)^{l-1}(a-x)^{m-1} dx = (a-b)^{l+m-1} B(l, m).$$

Here the limits have been changed to any arbitrary constants a and b .

$$(5) \text{ Transform by the formula } \frac{a}{x} - \frac{b}{y} = a-b.$$

Here the limits remain unaltered, for if $y=1$ we have $x=1$, and if $y=0$, $x=0$.

$$\begin{aligned} B(l, m) &= \int_0^1 y^{l-1}(1-y)^{m-1} dy \\ &= \int_0^1 \left\{ \frac{bx}{a+(b-a)x} \right\}^{l-1} \left\{ \frac{a(1-x)}{a+(b-a)x} \right\}^{m-1} \frac{ab dx}{\{a+(b-a)x\}^2} \\ &= a^m b^l \int_0^1 \frac{x^{l-1}(1-x)^{m-1}}{\{a+(b-a)x\}^{l+m}} dx. \end{aligned}$$

$$\text{Hence} \quad \int_0^1 \frac{x^{l-1}(1-x)^{m-1}}{\{a+(b-a)x\}^{l+m}} dx = \frac{1}{a^m b^l} B(l, m);$$

$$\text{also obviously} \quad \int_0^1 \frac{x^{l-1}(1-x)^{m-1}}{\{b+(a-b)x\}^{l+m}} dx = \frac{1}{a^l b^m} B(l, m);$$

and if we write $a-b=c$,

$$\int_0^1 \frac{x^{l-1}(1-x)^{m-1}}{(b+cx)^{l+m}} dx = \frac{1}{(b+c)^l b^m} B(l, m).$$

(6) In the last transformation, put $x = \sin^2 \theta$.

$$\text{Then } \int_0^{\frac{\pi}{2}} \frac{\sin^{2l-2} \theta \cos^{2m-2} \theta}{(a \cos^2 \theta + b \sin^2 \theta)^{l+m}} 2 \sin \theta \cos \theta d\theta = \frac{1}{a^m b^l} B(l, m),$$

$$\text{i.e. } \int_0^{\frac{\pi}{2}} \frac{\sin^{2l-1} \theta \cos^{2m-1} \theta}{(a \cos^2 \theta + b \sin^2 \theta)^{l+m}} d\theta = \frac{1}{2 a^m b^l} B(l, m),$$

l, m, a and b being positive constants.

(7) $I = \int_0^{\frac{\pi}{2}} \sin^p \theta \cos^q \theta d\theta$ is expressible in the same way in terms of a Beta function.

$$\text{Let } \sin \theta = \sqrt{x}, \quad \text{i.e. } \cos \theta d\theta = \frac{1}{2\sqrt{x}} dx.$$

$$\begin{aligned} I &= \int_0^1 x^{\frac{p}{2}} (1-x)^{\frac{q-1}{2}} \frac{1}{2\sqrt{x}} dx \\ &= \frac{1}{2} \int_0^1 x^{\frac{p+1}{2}-1} (1-x)^{\frac{q+1}{2}-1} dx \\ &= \frac{1}{2} B\left(\frac{p+1}{2}, \frac{q+1}{2}\right). \end{aligned}$$

This also follows from No. (6) by putting $a = b = 1$.

860. Properties of the Gamma Function.

Consider next the Gamma function, viz.

$$\Gamma(n) = \int_0^{\infty} x^{n-1} e^{-x} dx.$$

Integrating by parts

$$\Gamma(n) = \left[-x^{n-1} e^{-x} \right]_0^{\infty} + (n-1) \int_0^{\infty} e^{-x} x^{n-2} dx,$$

and whatever n may be, provided it be finite and > 1 , $-x^{n-1} e^{-x}$ vanishes at both limits.

$$\text{Hence } \Gamma(n) = (n-1) \Gamma(n-1).$$

Similarly, $\Gamma(n-1) = (n-2) \Gamma(n-2)$,
and so on.

In the case then, where n is a positive integer,

$$\Gamma(n) = (n-1)(n-2)(n-3) \dots 3 \cdot 2 \cdot 1 \Gamma(1),$$

$$\text{and } \Gamma(1) = \int_0^{\infty} e^{-x} dx = \left[-e^{-x} \right]_0^{\infty} = 1,$$

whence $\Gamma(n) = (n-1)!$ in that case.

861. Working Properties.

We then have the properties

$$\Gamma(n+1) = n \Gamma(n), \dots\dots\dots \text{I.}$$

$$\Gamma(1) = 1; \dots\dots\dots \text{II.}$$

and when n is a positive integer,

$$\Gamma(n+1) = n! \dots\dots\dots \text{III.}$$

The Gamma functions of the positive integers are then

$$\Gamma(1) = 1,$$

$$\Gamma(2) = 1 \cdot 1 = 1,$$

$$\Gamma(3) = 2 \Gamma(2) = 1 \cdot 2,$$

$$\Gamma(4) = 3 \Gamma(3) = 1 \cdot 2 \cdot 3,$$

$$\Gamma(5) = 4 \Gamma(4) = 1 \cdot 2 \cdot 3 \cdot 4,$$

etc,

from which a rough idea of the march of $\Gamma(x)$ as a continuous function may be inferred, viz. a minimum existing somewhere between $x=1$ and $x=2$, and then after $x=2$ a quantity increasing more and more rapidly.

862. In any case the equation $\Gamma(n+1) = n \Gamma(n)$ furnishes a means of reduction of the Gamma function of any number greater than unity to a Gamma function of a number less than unity.

For instance

$$\begin{aligned} \Gamma\left(\frac{7}{3}\right) &= \frac{4}{3} \Gamma\left(\frac{4}{3}\right) = \frac{4}{3} \cdot \frac{11}{3} \Gamma\left(\frac{1}{3}\right) = \frac{4}{3} \cdot \frac{11}{3} \cdot \frac{8}{3} \Gamma\left(\frac{2}{3}\right) = \frac{4}{3} \cdot \frac{11}{3} \cdot \frac{8}{3} \cdot \frac{5}{3} \Gamma\left(\frac{5}{3}\right) \\ &= \frac{4}{3} \cdot \frac{11}{3} \cdot \frac{8}{3} \cdot \frac{5}{3} \cdot \frac{2}{3} \Gamma\left(\frac{2}{3}\right). \end{aligned}$$

That is, the Gamma function of any number greater than unity can be connected with the Gamma function of a number which is not greater than unity; so that it is already obvious that when we come to the calculation and tabulation of the numerical values of Gamma functions it will be unnecessary to tabulate $\Gamma(x)$ for any values of x except those which lie between 0 and 1.

863. A Caution.

The student should guard against the idea that the equations

$$\Gamma(x) = \int_0^{\infty} e^{-v} v^{x-1} dv \quad \text{and} \quad \Gamma(x+1) = x \Gamma(x)$$

are co-equivalent. They are not so. The latter is a conse-

quence of the former, not the former of the latter. The latter is a functional or difference equation, viz.

$$\phi(x+1) = x\phi(x) \quad \text{or} \quad u_{x+1} = xu_x,$$

and such equations may have many solutions. What is proved is that $u_x = \int_0^\infty e^{-v} v^{x-1} dv$ is a particular solution of $u_{x+1} = xu_x$.

But so also are $A \int_0^\infty e^{-v} v^{x-1} dv$ when A is any constant, or such an expression as

$$\frac{A + B \cos^4 2\pi x}{C + D \sin^6 2\pi x} \int_0^\infty e^{-v} v^{x-1} dv$$

where A, B, C, D are constants, for these multipliers are not altered when x is increased by unity. Nor does it follow that $\int_0^\infty e^{-v} v^{x-1} dv$ occurs as a factor in all solutions of the difference equation.

The solution of $u_{x+1} = xu_x$ is obviously

$$Ax(x-1)(x-2) \dots (r+1)ru_r,$$

when A is either a constant or some arbitrary periodic function of x whose periodicity is unity, and which therefore does not alter when x is increased or decreased by any integer, and u_r any assumed initial value of u_x . We shall return to this matter later.

864. Transformation of the Gamma Function.

As in the case of the Beta function, transformations of the variable will give rise to other integrals.

(1) We have seen that $x = \log \frac{1}{y}$ or $y = e^{-x}$ produces

$$\Gamma(n) \equiv \int_0^\infty x^{n-1} e^{-x} dx = \int_0^1 \left(\log \frac{1}{y} \right)^{n-1} dy,$$

the form studied by Euler.

(2) If we write kx for x ,

$$\Gamma(n) = \int_0^\infty e^{-kx} k^n x^{n-1} dx;$$

whence
$$\int_0^\infty e^{-kx} x^{n-1} dx = \frac{\Gamma(n)}{k^n}$$

provided k be a real constant (see Arts. 1159 to 1162 and 1327).

(3) If we put $x^n=y$ where n is positive,

$$\Gamma(n) = \frac{1}{n} \int_0^\infty e^{-y^{\frac{1}{n}}} dy;$$

$$\therefore \int_0^\infty e^{-y^{\frac{1}{n}}} dy = n \Gamma(n) = \Gamma(n+1).$$

In this case, if we put $n = \frac{1}{2}$,

$$\int_0^\infty e^{-y^2} dy = \int_0^\infty e^{-x^2} dx = \frac{1}{2} \Gamma\left(\frac{1}{2}\right),$$

and this leads to an easy calculation of $\Gamma\left(\frac{1}{2}\right)$.

For
$$\left\{\frac{1}{2} \Gamma\left(\frac{1}{2}\right)\right\}^2 = \int_0^\infty e^{-x^2} dx \times \int_0^\infty e^{-y^2} dy,$$

and as x and y are independent variables and the limits constant, we may write this as

$$\int_0^\infty \int_0^\infty e^{-(x^2+y^2)} dx dy.$$

Now, regarding x, y as the Cartesian coordinates of a point we have to sum all such elements as $e^{-(x^2+y^2)} \delta x \delta y$ through an infinite square in the positive quadrant, two of whose sides are the coordinate axes.

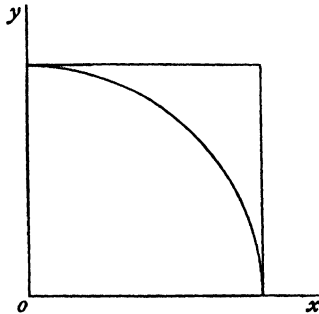

Fig. 313.

Transforming to polars, we have to sum

$$e^{-r^2} r \delta\theta \delta r$$

through the same square.

Let $x=a, y=a$, where $a=\infty$, be the other two sides of the square. Then for the portion of the square which lies inside the circle $x^2+y^2=a^2$ the limits for θ are 0 and $\frac{\pi}{2}$, and for r 0 and ∞ .

Hence the portion within the circular quadrant contributes

$$\int_0^{\frac{\pi}{2}} \int_0^{\frac{\pi}{2}} e^{-r^2} r dr d\theta = \frac{\pi}{2} \int_0^{\frac{\pi}{2}} r e^{-r^2} dr = \frac{\pi}{2} \left[-\frac{1}{2} e^{-r^2} \right]_0^{\frac{\pi}{2}} = \frac{\pi}{4}.$$

At points of the square outside the circle the elements are never greater than $e^{-a^2} r \delta\theta \delta r$, and when a is made sufficiently great this becomes an infinitesimal of higher degree than the second, and hence in the double integration disappears. Therefore the portion of the area between the circle and the square, exterior to the circle, contributes nothing.

Hence the value of $\Gamma(\frac{1}{2})$ is $\pm\sqrt{\pi}$, and as all the Gamma functions are from the definition essentially positive quantities,

$$\Gamma(\frac{1}{2}) = \sqrt{\pi}.*$$

865. We may also regard the investigation of $\int_0^{\infty} e^{-u^2} du$ as the problem of finding the volume† bounded by the plane of x - y and the surface formed by the revolution about the z -axis of the curve $z = e^{-x^2}$, for this volume may be regarded as

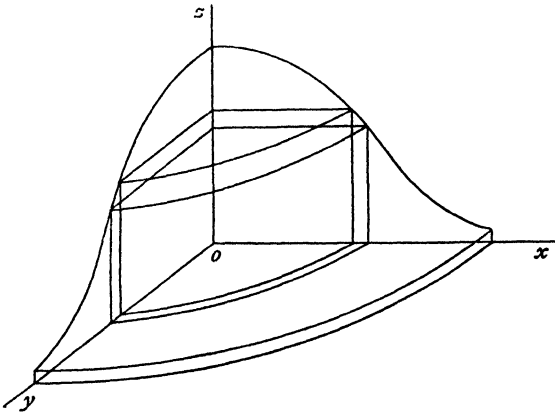

Fig. 314.

being built up of cylindrical shells whose axes coincide with the z -axis. The volume of this solid is then $\int_0^{\infty} 2\pi u du \cdot z$, where u is the radius of a section parallel to the x - y plane,

$$= 2\pi \int_0^{\infty} u e^{-u^2} du = \pi.$$

* Euler, Tom. V., *des anciens Mémoires de Pétersbourg*, p. 44.

† Airy, *Errors of Observation*, p. 12.

But dividing it by planes parallel to the coordinate planes of $x=0$ and $y=0$, the volume is also expressed by

$$\int_{-\infty}^{\infty} \left[\int_{-\infty}^{\infty} e^{-(x^2+y^2)} dy \right] dx = \int_{-\infty}^{\infty} e^{-x^2} dx \times \int_{-\infty}^{\infty} e^{-y^2} dy$$

$$= 4 \left(\int_0^{\infty} e^{-x^2} dx \right)^2;$$

whence
$$\int_0^{\infty} e^{-x^2} dx = \frac{\sqrt{\pi}}{2}.$$

This gives another geometrical interpretation to the work of the preceding article.

866. When n is diminished without limit $\int_0^{\infty} e^{-x} x^{n-1} dx$ becomes infinite. For the formula $\Gamma(n+1) = n\Gamma(n)$ holds for all positive values of n . Hence

$$Lt_{n=0} \Gamma(n) = Lt \frac{\Gamma(n+1)}{n} = Lt_{n=0} \frac{1}{n} = \infty,$$

i.e. $\Gamma(0) = \infty$.

This is also obvious from the integral itself. For the integrand $\frac{e^{-x}}{x}$ (for the case $n=0$) takes an ∞ value at the lower limit, and the principal value of the integral becomes infinite (see Art. 348).

867. Connection of the Two Functions.

We shall next prove that the Beta function is expressible in terms of Gamma functions, the connection being

$$B(l, m) = \frac{\Gamma(l) \cdot \Gamma(m)}{\Gamma(l+m)}.$$

Consider the double integral

$$I = \int_0^{\infty} \int_0^{\infty} e^{-xy} (xy)^{l-1} \times e^{-x} x^m dx dy$$

[that is xy is written for x in the integrand of $\Gamma(l)$, and this is multiplied by the factors of the integrand of $\Gamma(m+1)$], *i.e.*

$$I = \int_0^{\infty} \int_0^{\infty} e^{-x(y+1)} x^{l+m-1} y^{l-1} dy dx.$$

Integrating first with regard to x , we have

$$I = \int_0^{\infty} y^{l-1} \frac{\Gamma(l+m)}{(1+y)^{l+m}} dy$$

$$= \Gamma(l+m) B(l, m), \text{ by Art. 859 (2).}$$

But changing the order of integration, taking y first,

$$\begin{aligned} I &= \int_0^\infty \int_0^\infty e^{-x} x^{l+m-1} y^{l-1} e^{-xy} dx dy \\ &= \int_0^\infty e^{-x} x^{l+m-1} \frac{\Gamma(l)}{x^l} dx \\ &= \Gamma(l) \int_0^\infty e^{-x} x^{m-1} dx \\ &= \Gamma(l) \Gamma(m). \end{aligned}$$

Hence $B(l, m) = \frac{\Gamma(l) \Gamma(m)}{\Gamma(l+m)}$.

868. Deductions.

It further follows that

$$B(l+m, n) = \frac{\Gamma(l+m) \Gamma(n)}{\Gamma(l+m+n)},$$

and therefore that

$$B(l, m) B(l+m, n) = \frac{\Gamma(l) \Gamma(m) \Gamma(n)}{\Gamma(l+m+n)},$$

which is a symmetric function of l, m, n . Hence we have

$$B(l, m) B(l+m, n) = B(m, n) B(m+n, l) = B(n, l) B(n+l, m).$$

Hence also

$$B(l, m) B(l+m, n) B(l+m+n, p) = \frac{\Gamma(l) \Gamma(m) \Gamma(n) \Gamma(p)}{\Gamma(l+m+n+p)}, \text{ etc.}$$

869. It now follows that the results of the transformations of the Beta function given in Art. 859 could be further expressed as Gamma functions.

Thus

$$\int_0^1 \frac{x^{l-1} (1-x)^{m-1} dx}{(b+cx)^{l+m}} = \frac{1}{(b+c)^l b^m} B(l, m) = \frac{1}{(b+c)^l b^m} \frac{\Gamma(l) \Gamma(m)}{\Gamma(l+m)},$$

$$\int_0^{\frac{\pi}{2}} \frac{\sin^{2l-1} \theta \cos^{2m-1} \theta}{(a \cos^2 \theta + b \sin^2 \theta)^{l+m}} d\theta = \frac{1}{2a^m b^l} B(l, m) = \frac{1}{2a^m b^l} \frac{\Gamma(l) \Gamma(m)}{\Gamma(l+m)},$$

$$\int_0^{\frac{\pi}{2}} \sin^p \theta \cos^q \theta d\theta = \frac{1}{2} B\left(\frac{p+1}{2}, \frac{q+1}{2}\right) = \frac{\Gamma\left(\frac{p+1}{2}\right) \Gamma\left(\frac{q+1}{2}\right)}{2\Gamma\left(\frac{p+q}{2}+1\right)},$$

etc.

The last of these integrals has already been used in earlier chapters, for convenience of calculation, with a temporary and limited definition of Γ .

870. We have also in Art. 859, Case 2, the integral

$$\int_0^{\infty} \frac{x^{m-1}}{(1+x)^{l+m}} dx = B(l, m) = \frac{\Gamma(l) \Gamma(m)}{\Gamma(l+m)}.$$

Put $l+m=1$. Then, since $\Gamma(1)=1$, we have

$$\Gamma(m) \Gamma(1-m) = \int_0^{\infty} \frac{x^{m-1}}{1+x} dx,$$

where m is a positive proper fraction.

We have then to consider this integral next.

871. **The Integral** $I \equiv \int_0^{\infty} \frac{x^{n-1}}{1+x} dx$ where $0 < n < 1$.

The integration \int_0^{∞} may be separated into two parts, viz.

$$\int_0^1 + \int_1^{\infty}.$$

In the second part put $x = \frac{1}{y}$.

Then

$$\int_1^{\infty} \frac{x^{n-1}}{1+x} dx = \int_1^0 \frac{y^{1-n}}{1+\frac{1}{y}} \left(-\frac{1}{y^2}\right) dy = \int_0^1 \frac{y^{-n}}{1+y} dy = \int_0^1 \frac{x^{-n}}{1+x} dx.$$

Hence
$$I \equiv \int_0^1 \frac{x^{n-1} + x^{-n}}{1+x} dx,$$

and by division

$$\frac{1}{1+x} = 1 - x + x^2 - x^3 + \dots + (-1)^k x^k + (-1)^{k+1} \frac{x^{k+1}}{1+x}.$$

Hence

$$\begin{aligned} I &\equiv \int_0^1 (x^{n-1} + x^{-n})(1 - x + x^2 - \dots + (-1)^k x^k) \\ &\quad + (-1)^{k+1} \int_0^1 x^{k+1} \frac{x^{n-1} + x^{-n}}{1+x} dx \\ &\left\{ \frac{1}{n} - \frac{1}{1+n} + \frac{1}{2+n} - \frac{1}{3+n} + \dots + (-1)^k \frac{1}{k+n} \right. \\ &\quad \left. + \frac{1}{1-n} - \frac{1}{2-n} + \frac{1}{3-n} - \dots - (-1)^k \frac{1}{k-n} + (-1)^k \frac{1}{k-n+1} \right\} \\ &\quad + (-1)^{k+1} \int_0^1 x^{k+1} \frac{x^{n-1} + x^{-n}}{1+x} dx. \end{aligned}$$

Now $\operatorname{cosec} z =$

$$\frac{1}{z} - \frac{1}{z+\pi} - \frac{1}{z-\pi} + \frac{1}{z+2\pi} + \frac{1}{z-2\pi} - \frac{1}{z+3\pi} - \frac{1}{z-3\pi} + \dots \text{ to } \infty.$$

(Hobson, *Trigonometry*, p. 335.)

Hence

$$\begin{aligned} & \frac{1}{n} - \frac{1}{1+n} + \frac{1}{1-n} + \frac{1}{2+n} - \frac{1}{2-n} - \frac{1}{3+n} + \frac{1}{3-n} + \dots \text{ to } \infty \\ & = \frac{\pi}{\sin n\pi}; \end{aligned}$$

and since in the limit when k is made indefinitely large the last term of the series for I , viz. $(-1)^k \frac{1}{k-n+1}$ becomes zero, the portion of I within the brackets becomes $\frac{\pi}{\sin n\pi}$.

Also as to the remainder, viz. $\int_0^1 \frac{x^{k+1} x^{n-1} + x^{-n}}{1+x} dx$, we may note that as x lies between 0 and 1 and is a positive proper fraction, x^{k+1} is diminished indefinitely by an infinite increase in k . If then this integration be expressed as a summation according to the definition of Art. 11, each term of the summation is diminished without limit, and may be regarded as an infinitesimal of the second or higher order when k is sufficiently increased.

$$\text{Hence} \quad \lim_{k \rightarrow \infty} \int_0^1 x^{k+1} \frac{x^{n-1} + x^{-n}}{1+x} dx = 0,$$

and we are left with

$$\int_0^1 \frac{x^{n-1}}{1+x} dx = \frac{\pi}{\sin n\pi} \quad \text{where } 0 < n < 1.$$

872. An Important Result.

It now follows that

$$\Gamma(n) \Gamma(1-n) = \frac{\pi}{\sin n\pi} \quad (0 < n < 1).$$

As a particular case put $n = \frac{1}{2}$.

$$\left\{ \Gamma\left(\frac{1}{2}\right) \right\}^2 = \frac{\pi}{\sin \frac{\pi}{2}} = \pi,$$

and

$$\Gamma\left(\frac{1}{2}\right) = \sqrt{\pi}, \text{ as has been seen before, Art. 864.}$$

Again, put $n = \frac{1}{4}$.

$$\Gamma\left(\frac{1}{4}\right)\Gamma\left(\frac{3}{4}\right) = \frac{\pi}{\sin \frac{\pi}{4}} = \pi\sqrt{2}; \quad \therefore \Gamma\left(\frac{3}{4}\right) = \frac{\pi\sqrt{2}}{\Gamma\left(\frac{1}{4}\right)}.$$

Put $n = \frac{1}{6}$.

$$\Gamma\left(\frac{1}{6}\right)\Gamma\left(\frac{5}{6}\right) = \frac{\pi}{\sin \frac{\pi}{6}} = 2\pi; \quad \therefore \Gamma\left(\frac{5}{6}\right) = \frac{2\pi}{\Gamma\left(\frac{1}{6}\right)}, \text{ etc.}$$

Hence $\Gamma\left(\frac{3}{4}\right)$, $\Gamma\left(\frac{5}{6}\right)$, etc., are expressed in terms of Gamma functions of numbers which are $< \frac{1}{2}$; whence it will appear that if all Gamma functions were tabulated from $\Gamma(0)$ to $\Gamma\left(\frac{1}{2}\right)$, all others could be found by this theorem, together with the theorem $\Gamma(n+1) = n\Gamma(n)$.

The result $\Gamma(n)\Gamma(1-n) = \frac{\pi}{\sin n\pi}$, was temporarily borrowed in an earlier chapter, Art. 592, in the calculation of a certain arc of a Lemniscate.

Since $\Gamma(1+n) = n\Gamma(n)$ and $\Gamma(n)\Gamma(1-n) = \frac{\pi}{\sin n\pi}$, this formula may be written

$$\Gamma(1+n)\Gamma(1-n) = \frac{n\pi}{\sin n\pi} \quad (0 < n < 1).$$

873. To show that

$$\Gamma\left(\frac{1}{n}\right)\Gamma\left(\frac{2}{n}\right)\Gamma\left(\frac{3}{n}\right)\dots\Gamma\left(\frac{n-1}{n}\right) = \frac{(2\pi)^{\frac{n-1}{2}}}{n^{\frac{1}{2}}}.$$

We are now able to consider the continued product

$$P \equiv \Gamma\left(\frac{1}{n}\right)\Gamma\left(\frac{2}{n}\right)\Gamma\left(\frac{3}{n}\right)\dots\Gamma\left(\frac{n-1}{n}\right),$$

where n for the present is any positive integer.

By writing it down again in the reverse order, multiplying the results, and noting that

$$\Gamma\left(\frac{r}{n}\right)\Gamma\left(1-\frac{r}{n}\right) = \frac{\pi}{\sin \frac{r}{n}\pi} \quad (r < n),$$

we have

$$P^2 = \frac{\pi}{\sin \frac{\pi}{n}} \cdot \frac{\pi}{\sin \frac{2\pi}{n}} \cdot \frac{\pi}{\sin \frac{3\pi}{n}} \dots \frac{\pi}{\sin \frac{(n-1)\pi}{n}}.$$

and since

$$\frac{\sin n\theta}{\sin \theta} = 2^{n-1} \sin\left(\theta + \frac{\pi}{n}\right) \sin\left(\theta + \frac{2\pi}{n}\right) \sin\left(\theta + \frac{3\pi}{n}\right) \dots \sin\left(\theta + \frac{(n-1)\pi}{n}\right),$$

(Hobson, *Trigonometry*, p. 117),

we have in the limit when $\theta=0$,

$$n = 2^{n-1} \sin \frac{\pi}{n} \sin \frac{2\pi}{n} \sin \frac{3\pi}{n} \dots \sin \frac{(n-1)\pi}{n}.$$

Hence $P^2 = \frac{\pi^{n-1}}{n} 2^{n-1}$, and P being positive, we have

$$\Gamma\left(\frac{1}{n}\right) \Gamma\left(\frac{2}{n}\right) \Gamma\left(\frac{3}{n}\right) \dots \Gamma\left(\frac{n-1}{n}\right) = \frac{(2\pi)^{\frac{n-1}{2}}}{n^{\frac{1}{2}}}.$$

874. Gauss' Π Function.

Taking the original Eulerian form of the Gamma function, viz.

$$\Gamma(n) = \int_0^1 \left(\log \frac{1}{x}\right)^{n-1} dx,$$

and remembering that $Lt_{\mu=\infty} \frac{1-x^\mu}{\frac{1}{\mu}} = \log \frac{1}{x}$ (*Diff. Calc.*, Art. 21)

we may write

$$\left(\log \frac{1}{x}\right)^{n-1} = \left\{ \frac{\left(1-x^\mu\right)^{\frac{1}{\mu}}}{\frac{1}{\mu}} \right\}^{n-1} + \epsilon,$$

where ϵ is something which vanishes in the limit when μ becomes infinite.

Let us take μ as a positive integer.

$$\text{Then } \Gamma(n) = \int_0^1 \mu^{n-1} \left(1-x^\mu\right)^{n-1} dx + \int_0^1 \epsilon dx.$$

In the first integral put $x=y^\mu$.

$$\text{Then } \Gamma(n) = \mu^n \int_0^1 y^{\mu-1} (1-y)^{n-1} dy + \int_0^1 \epsilon dx,$$

and as μ is a positive integer,

$$\int_0^1 y^{\mu-1} (1-y)^{n-1} dy = \frac{(\mu-1)!}{n(n+1) \dots (n+\mu-1)} \quad (\text{Art. 858}).$$

$$\text{Hence } \Gamma(n) = \mu^n \frac{(\mu-1)!}{n(n+1) \dots (n+\mu-1)} + \int_0^1 \epsilon dx.$$

Hence, making μ increase without limit, the integral ultimately vanishes, and

$$\Gamma(n) = Lt_{\mu=\infty} \mu^n \frac{(\mu-1)!}{n(n+1) \dots (n+\mu-1)},$$

or, which is the same thing,

$$\Gamma(n) = Lt_{\mu=\infty} \mu^{n-1} \frac{\mu!}{n(n+1) \dots (n+\mu-1)};$$

and writing $n+1$ for n ,

$$\Gamma(n+1) = Lt_{\mu=\infty} \mu^n \frac{1.2.3 \dots \mu}{(n+1) \dots (n+\mu)}.$$

This limit is known as Gauss' Π function, and is written

$$\Pi(n) = Lt_{\mu=\infty} \mu^n \frac{1.2.3 \dots \mu}{(n+1) \dots (n+\mu)},$$

or, which is the same thing,

$$Lt_{\mu=\infty} \frac{\mu^n}{\left(1+\frac{n}{1}\right)\left(1+\frac{n}{2}\right) \dots \left(1+\frac{n}{\mu}\right)}.$$

Here μ is integral, and n is essentially positive but not necessarily integral.

875. The limiting form at which we have arrived at the end of the last article plays an extremely important part in the development of the general theory of Gamma functions. It will be very desirable for the student to pay considerable attention to it, and we propose therefore, in due course, to consider at some length the general behaviour of the function

$\frac{1.2.3 \dots \mu}{(x+1)(x+2)(x+3) \dots (x+\mu)} \mu^x$ for different values of μ and for different values of x , and the only restriction we shall place upon it at present will be that μ is to be a positive integer, not necessarily large.

Two theorems, however, are required in dealing with such expressions as will arise, viz.

(1) **Wallis' Theorem**, which states that when n is a very large positive integer, $\frac{2.4.6 \dots 2n}{1.3.5 \dots (2n-1)}$ and $\sqrt{n\pi}$ become infinite in a ratio of equality, *i.e.*

$$Lt_{n=\infty} \frac{2.4.6 \dots 2n}{1.3.5 \dots (2n-1)} \frac{1}{\sqrt{n\pi}} = 1.$$

(2) **Stirling's Theorem**, which states that when n is a very large positive integer

$$1.2.3 \dots n \quad \text{and} \quad \sqrt{2n\pi} \cdot n^n \cdot e^{-n}$$

become infinite in a ratio of equality, that is

$$Lt_{n=\infty} \frac{n! e^n}{n^{n+\frac{1}{2}}} = \sqrt{2\pi}.$$

The first of these appears in most treatises on Trigonometry, for instance, Hobson's *Trigonometry*, p. 331, Ex. 1, but scarcely appears to receive the prominence in the text-books that it deserves. The second, Stirling's Theorem, is less available for the student; hence these theorems are reproduced here for present use.

876. Digression on Wallis' and Stirling's Theorems.

WALLIS. Expressing $\sin \theta$ as $\theta \left(1 - \frac{\theta^2}{\pi^2}\right) \left(1 - \frac{\theta^2}{2^2\pi^2}\right) \dots$ to ∞ , and putting $\theta = \frac{\pi}{2}$, we have

$$\begin{aligned} \frac{2}{\pi} &= \left(1 - \frac{1}{2^2}\right) \left(1 - \frac{1}{4^2}\right) \left(1 - \frac{1}{6^2}\right) \dots \\ &= \frac{1.3}{2^2} \cdot \frac{3.5}{4^2} \cdot \frac{5.7}{6^2} \dots \frac{(2n-1)(2n+1)}{(2n)^2} \dots \\ &= \frac{1^2 \cdot 3^2 \cdot 5^2 \dots (2n-1)^2}{2^2 \cdot 4^2 \cdot 6^2 \dots (2n)^2} (2n+1) \times (1-\epsilon), \end{aligned}$$

where ϵ becomes indefinitely small when n becomes indefinitely large.

Hence, when n is large, we have

$$\frac{2.4.6 \dots 2n}{1.3.5 \dots (2n-1)} = \sqrt{\frac{\pi}{2}} (2n+1) \text{ ultimately;}$$

and since n is very great, we have

$$Lt \frac{2.4 \dots 2n}{1.3 \dots (2n-1)} \cdot \frac{1}{\sqrt{n\pi}} = 1,$$

and $\frac{2.4 \dots 2n}{1.3 \dots (2n-1)}$ may be replaced by $\sqrt{n\pi}$, these expressions being ultimately equal. This is **Wallis' Theorem**.

877. STIRLING. Stirling's Theorem states that for very large values of n , $1.2.3 \dots n$ and $\sqrt{2n\pi} e^{-n} n^n$ are ultimately equal.

Write $\phi(n)$ for $1.2.3 \dots n$.

Then $\phi(2n) = 1.2.3 \dots 2n$

and $2^n \phi(n) = 2.4.6 \dots 2n$.

Hence Wallis' Theorem, which may be written as

$$\frac{2^2 \cdot 4^2 \cdot 6^2 \dots (2n)^2}{1.2.3.4 \dots (2n-1).2n} = \sqrt{n\pi},$$

gives
$$\frac{2^{2n} [\phi(n)]^2}{\phi(2n)} = \sqrt{n\pi}.$$

Let $\frac{\phi(n)}{n^n \sqrt{2n\pi}}$ be called $F(n)$.

Then $2^{2n} [n^n \sqrt{2n\pi} F(n)]^2 = \sqrt{n\pi} (2n)^{2n} \sqrt{4n\pi} F(2n)$,

i.e. $F(2n) = [F(n)]^2$.

To solve this functional equation, write $2n$ for n .

Then $F(2^2 n) = [F(2n)]^2 = [F(n)]^{2^2}$.

Similarly $F(2^3 n) = [F(n)]^{2^3}$, etc.,

and $F(2^p n) = [F(n)]^{2^p}$,

p being a positive integer.

Now, putting $2^p n = x$,

$$F(x) = \left\{ [F(n)]^{\frac{1}{n}} \right\}^x.$$

Let p increase indefinitely and n decrease indefinitely in such way as to keep the product $2^p n$ finite. Also let

$$L_{n=0} [F(n)]^{\frac{1}{n}}$$

be called k .

Then $F(x) = k^x$, which indicates the form of F to be exponential. We have to determine k .

Taking $1.2.3 \dots n \equiv \phi(n) = n^n \sqrt{2n\pi} k^n$,
change n to $n+1$.

$$1.2.3 \dots n.(n+1) = (n+1)^{n+1} \sqrt{2n+1\pi} k^{n+1}.$$

Hence, by division, $n+1 = \frac{(n+1)^{n+1}}{n^n} \cdot \frac{\sqrt{n+1}}{\sqrt{n}} \cdot k$,

i.e.
$$k^{-1} = \left(1 + \frac{1}{n}\right)^n \left(1 + \frac{1}{n}\right)^{\frac{1}{2}}$$

$$= e$$

in the limit when n is indefinitely large. Hence $k=e^{-1}$, and therefore $1.2.3 \dots n$ and $\sqrt{2n\pi} n^n e^{-n}$ become infinite with n , in a ratio of equality, or, what is the same thing,

$$\lim_{n \rightarrow \infty} \frac{e^n n!}{n^{n+\frac{1}{2}}} = \sqrt{2\pi}.$$

This is Stirling's Theorem. The result will be considered further in a subsequent article (Art. 884).

This particular form of proof was given by Dr. E. J. Routh in lectures at Cambridge (see also Dr. Glaisher on Stirling's Theorem in the *Messenger of Mathematics*).

878. Illustrations of the Use of Stirling's Theorem.

Stirling's Theorem is useful in such cases as involve factorials of large numbers.

1. Thus the middle coefficient of the expansion of $(1+x)^{2n}$ where n is a positive integer, viz. $\frac{(2n)!}{(n!)^2}$, is ultimately when n is very large,

$$= \frac{\sqrt{4n\pi} (2n)^{2n} e^{-2n}}{2n\pi n^{2n} e^{-2n}} = \frac{2^{2n}}{\sqrt{n\pi}}.$$

This is the limiting form. It is of course infinite itself, but for large values of n a close approximation will be thus obtained. Thus, for instance, even taking a case when n is not *exceedingly* large, in calculating

${}^{60}C_{30} = \frac{40!}{(20!)^2}$ and $\frac{2^{40}}{\sqrt{20\pi}}$ from the logarithm tables the latter only exceeds the former by about 0.7 per cent.; and in calculating ${}^{100}C_{50} = \frac{100!}{(50!)^2}$ and $\frac{2^{100}}{\sqrt{50\pi}}$, the latter only exceeds the former by about 0.25 per cent.; and the error is diminishing as the magnitude of the numbers dealt with increases.

Ultimately, for exceedingly large values of n , the middle coefficients of the successive expansions $(1+x)^{2n}$, $(1+x)^{2n+2}$, etc., form what is nearly a G.P. with common ratio,

$$\lim \frac{2^{2n+2}}{\sqrt{(n+1)\pi}} \bigg/ \frac{2^{2n}}{\sqrt{n\pi}}, \quad \text{i.e. } 4:1,$$

as is also directly obvious.

2. The n^{th} number of Bernoulli, viz. B_{2n-1} (see *Diff. Calc.*, p. 502), being given by

$$B_{2n-1} = \frac{2(2n)!}{(2\pi)^{2n}} \left(1 + \frac{1}{2^{2n}} + \frac{1}{3^{2n}} + \dots \right),$$

we have, when n is large,

$$\begin{aligned} B_{2n-1} &= 2 \frac{\sqrt{2n} \cdot 2\pi (2n)^{2n} e^{-2n}}{(2\pi)^{2n}} \\ &= 4\pi^{-2n+\frac{1}{2}} e^{-2n} n^{2n+\frac{1}{2}}. \end{aligned}$$

Similarly if $\frac{K_n}{n!}$ be the coefficient of x^n in the expansion of $\sec x + \tan x$, it is known that

$$K_n = \frac{2^{n+2}n!}{\pi^{n+1}} \left(1 + \left(-\frac{1}{2}\right)^{n+1} + \left(\frac{1}{2}\right)^{n+1} + \left(-\frac{1}{3}\right)^{n+1} + \dots \right),$$

which embraces the cases of Bernoullian numbers and Eulerian numbers together, viz.

$$K_{2n} \equiv \text{the } n^{\text{th}} \text{ Eulerian number,}$$

$$K_{2n-1} \equiv \frac{2^{2n}(2^{2n}-1)}{2n} B_{2n-1}$$

(see *Diff. Calc.*, Art. 573, etc.),

and we have when n is very large,

$$K_n = \frac{2^{n+2}}{\pi^{n+1}} \sqrt{2n\pi} n^n e^{-n} = 2^{n+\frac{1}{2}} \left(\frac{n}{\pi}\right)^{n+\frac{1}{2}} e^{-n}.$$

In this expansion, viz.

$$\sec x + \tan x = 1 + K_1 \frac{x}{1!} + K_2 \frac{x^2}{2!} + K_3 \frac{x^3}{3!} + \dots,$$

the ratio of the $(n+1)^{\text{th}}$ term to the n^{th} is

$$\frac{K_n}{K_{n-1}} \frac{x}{n},$$

and when n is large this becomes

$$\begin{aligned} Lt \frac{2^{n+\frac{1}{2}} \left(\frac{n}{\pi}\right)^{n+\frac{1}{2}} e^{-n}}{2^{n+\frac{1}{2}} \left(\frac{n-1}{\pi}\right)^{n-\frac{1}{2}} e^{-n+1}} \cdot \frac{x}{n} \\ = Lt \frac{2}{\pi e} \cdot \frac{1}{\left(1 - \frac{1}{n}\right)^n} \cdot n^{\frac{1}{2}}(n-1)^{\frac{1}{2}} \cdot \frac{x}{n} \\ = Lt \frac{2}{\pi e} \cdot \frac{1}{e^{-1}} \cdot n \cdot \frac{x}{n} = \frac{2x}{\pi}. \end{aligned}$$

It appears that, since $Lt \frac{K_n}{K_{n-1}} = \frac{2n}{\pi}$, the coefficients increase with great rapidity ultimately, and the series will be divergent for values of $x < \frac{\pi}{2}$.

3. In the series which gives rise to the Bernoullian numbers, viz.

$$\frac{x}{2} \coth \frac{x}{2} \equiv \frac{x}{e^x - 1} + \frac{x}{2} = 1 + B_1 \frac{x^2}{2!} - B_3 \frac{x^4}{4!} + B_5 \frac{x^6}{6!} - \dots + (-1)^{n-1} B_{2n-1} \frac{x^{2n}}{(2n)!} + \dots,$$

the ratio of the $(n+1)^{\text{th}}$ term to the n^{th} is

$$- \frac{B_{2n-1}}{B_{2n-3}} \frac{x^2}{(2n-1)(2n)},$$

and when n is large,

$$\begin{aligned} &= -Lt \frac{4\pi^{-2n+\frac{1}{2}} e^{-2n} n^{2n+\frac{1}{2}}}{4\pi^{-2n+\frac{1}{2}} e^{-2n+2} (n-1)^{2n-\frac{1}{2}}} \cdot \frac{x^2}{(2n-1)2n} \\ &= -Lt \frac{1}{\pi^2} \cdot \frac{1}{e^2} \cdot \frac{1}{\left(\frac{1-1}{n}\right)^{2n}} \cdot n^{\frac{1}{2}} (n-1)^{\frac{1}{2}} \cdot \frac{x^2}{(2n-1)2n} \\ &= -Lt \frac{1}{\pi^2} \cdot \frac{1}{e^2} \cdot \frac{1}{e^{-2}} \cdot n^2 \cdot \frac{x^2}{4n^2} \\ &= -\frac{x^2}{4\pi^2}. \end{aligned}$$

The series is therefore divergent for values of $x^2 < (2\pi)^2$, and as

$$Lt \frac{B_{2n-1}}{B_{2n-3}} = Lt \frac{(2n-1)2n}{4\pi^2} = \frac{n^2}{\pi^2} \text{ ultimately,}$$

the Bernoullian numbers ultimately increase with great rapidity.

It will be noted that $\coth \frac{x}{2}$ becomes infinite if x have the unreal value 2π . When x is complex it is therefore necessary to limit expansion to the case for which the modulus of the complex is $< 2\pi$.*

879. A method of Calculation of the Numbers of Bernoulli and the Numbers of Euler is explained in the *Differential Calculus*, Art. 573. Both sets have been calculated for many coefficients of their respective series (see *Proceedings of the British Association* 1877), and probably far enough for all practical purposes for which they will ever be required. Several are quoted on pages 106 and 501 of the *Differential Calculus*. A few extra results are put upon record here for reference, for the convenience of the reader. Also, as we are about to deal with such sums as $\frac{1}{1^p} + \frac{1}{2^p} + \frac{1}{3^p} + \dots$ to $\infty \equiv S_p$, which for even values of p are to be found from

$$B_{2n-1} = \frac{2(2n)!}{(2\pi)^{2n}} S_{2n},$$

we tabulate a few of these results also.

$$B_1 = \frac{1}{6}, B_3 = \frac{1}{42}, B_5 = \frac{1}{30}, B_7 = \frac{1}{42}, B_9 = \frac{1}{30}, B_{11} = \frac{1}{42}, B_{13} = \frac{1}{30},$$

$$B_{15} = \frac{1}{42}, B_{17} = \frac{1}{42}, B_{19} = \frac{1}{42};$$

$$E_2 = -1, E_4 = 5, E_6 = 61, E_8 = 1385, E_{10} = 50521;$$

$$S_2 = \frac{\pi^2}{6}, S_4 = \frac{\pi^4}{90}, S_6 = \frac{\pi^6}{945}, S_8 = \frac{\pi^8}{9450}, S_{10} = \frac{\pi^{10}}{93555}.$$

The values of S_p up to S_{36} reduced to decimals will be found tabulated later for purposes of evaluation of integrals to be discussed (Art. 957).

880. For other methods of Calculation of Bernoulli's Numbers etc., see Boole, *Finite Differences*, Chapter VI.

881. We note that $B_1 > B_3 > B_5 < B_7 < B_9 < \dots$, and the coefficient B_5 is the smallest of Bernoulli's Numbers, after which they rapidly increase.

* See Bertrand, *Calc. Diff.*, Art. 412.

882. **The Value of $\Pi(\frac{1}{2})$.**

Consider next the case of Gauss' II function for $n = \frac{1}{2}$.

$$\begin{aligned} \Pi\left(\frac{1}{2}\right) &= Lt_{\mu=\infty} \frac{1 \cdot 2 \cdot 3 \dots \mu}{2 \cdot 2 \dots \frac{2\mu+1}{2}} \mu^{\frac{1}{2}} \\ &= Lt_{\mu=\infty} \frac{2^2 \cdot 4^2 \cdot 6^2 \dots (2\mu)^2}{1 \cdot 2 \cdot 3 \cdot 4 \dots (2\mu)(2\mu+1)} \mu^{\frac{1}{2}} \\ &= Lt_{\mu=\infty} \frac{2^{2\mu} (\mu!)^2}{(2\mu+1)!} \mu^{\frac{1}{2}} \\ &= Lt_{\mu=\infty} \frac{2^{2\mu} 2\mu\pi \cdot \mu^{2\mu} \cdot e^{-2\mu}}{\sqrt{(4\mu+2)\pi} (2\mu+1)^{2\mu+1} e^{-(2\mu+1)}} \mu^{\frac{1}{2}} \\ &= Lt_{\mu=\infty} e\sqrt{\pi} \frac{1}{\left(1+\frac{1}{2\mu}\right)^{2\mu}} \frac{1}{\left(1+\frac{1}{2\mu}\right)} \frac{\mu^{\frac{1}{2}}}{2\sqrt{\mu+\frac{1}{2}}} \\ &= e\sqrt{\pi} \cdot \frac{1}{e} \cdot 1 \cdot \frac{1}{2} = \frac{\sqrt{\pi}}{2}; \end{aligned}$$

whence $\Pi\left(\frac{1}{2}\right) = \frac{\sqrt{\pi}}{2}$.

It will be remembered that for positive values of n ,

$$\Pi(n) = \Gamma(n+1);$$

therefore $\Gamma\left(\frac{3}{2}\right) = \Pi\left(\frac{1}{2}\right) = \frac{\sqrt{\pi}}{2}$ and $\Gamma\left(\frac{3}{2}\right) = \frac{1}{2} \Gamma\left(\frac{1}{2}\right)$;

$$\therefore \Gamma\left(\frac{1}{2}\right) = \sqrt{\pi},$$

which agrees with Art. 864.

883. **The Graph of $y = x^n e^{-x}$.**

We shall next study the nature of the family of curves

$$y = x^n e^{-x}$$

for various values of n .

The subject of integration in the Gamma Function $\Gamma(n+1)$ viz. $x^n e^{-x}$, has a maximum value when

$$nx^{n-1}e^{-x} - x^n e^{-x} = 0, \text{ i.e. when } x = n \quad (n > 0),$$

and the maximum ordinate of the curve $y = x^n e^{-x}$ for positive values of x is $n^n e^{-n}$.

The graphs of the members of this family for $n=0$, $n=0.5$, $n=1$, $n=2$ are shown in the accompanying figure for the first quadrant, which is all we require.

The case $n=0$, viz. $y=e^{-x}$, is a logarithmic curve, and cuts the y -axis at a point $y=1$. It has no maximum ordinate

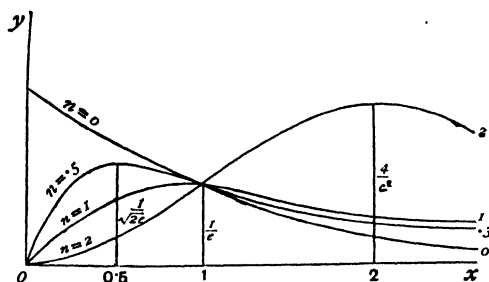

Fig. 315.

The case $n=0.5$ has a maximum ordinate at $x=\frac{1}{2}$, viz. $\frac{1}{\sqrt{2e}}$, and then runs to the positive end of the x -axis asymptotically.

The case $n=1$ has a maximum at $x=1$, viz. $\frac{1}{e}$.

The case $n=2$ has a maximum at $x=2$, viz. $\frac{4}{e^2}$.

All the curves have the x -axis as an asymptote, and all go through the point $(1, \frac{1}{e})$, where they cross.

For values of n between 0 and 1, the curves touch the y -axis at the origin.

The case $n=1$ touches the line $y=x$ at the origin.

The cases for $n > 1$ touch the x -axis at the origin.

The several maxima, viz. $n^n e^{-n}$, diminish for various values of n from $n=0$ to $n=1$, and then increase again, all the crests the curves lying upon $y=x^n e^{-x}$, i.e.

$$y = \left(\frac{x}{e}\right)^x$$

the least of the maximum ordinates being at $x=1$, and belonging to the curve $y=x e^{-x}$.

The area bounded by any of these curves $y=x^n e^{-x}$, the x -axis and the ordinate at $x=\infty$, is

$$\int_0^{\infty} e^{-x} x^n dx, \quad \text{i.e. } \Gamma(n+1),$$

and increases without limit as n increases.

884. **Extension of Stirling's Theorem.**

We have shown (Stirling's Theorem) that when n is a large positive integer,

$$1 \cdot 2 \cdot 3 \dots n = \sqrt{2n\pi} n^n e^{-n},$$

the meaning of the equality sign being that these quantities become infinite in a ratio of equality.

We proceed to show that even when n is not integral, but still positive,

$$\Gamma(n+1) = \sqrt{2n\pi} n^n e^{-n},$$

when n is indefinitely increased.

We have
$$\Gamma(n+1) = \int_0^\infty x^n e^{-x} dx.$$

Let us transform this integral by putting

$$x^n e^{-x} = n^n e^{-n} e^{-\frac{n}{2}t^2}, \dots\dots\dots(1)$$

which is legitimate, as $n^n e^{-n}$ has been shown to be the maximum value of $x^n e^{-x}$.

Now, as t ranges from $-\infty$ through zero to $+\infty$,

x ranges from 0 through n to $+\infty$.

Thus
$$\frac{\Gamma(n+1)}{n^n e^{-n}} = \int_{-\infty}^{\infty} e^{-\frac{n}{2}t^2} \frac{dx}{dt} dt,$$

and we have to find $\frac{dx}{dt}$. Let $x = n(1+\tau)$.

Then
$$(n+n\tau)^n e^{-n} e^{-n\tau} = n^n e^{-n} e^{-\frac{n}{2}t^2};$$

$$\therefore (1+\tau)^n e^{-n\tau} = e^{-\frac{n}{2}t^2} \quad \text{and} \quad \log(1+\tau) - \tau = -\frac{t^2}{2}. \dots(2)$$

Clearly τ vanishes with t , and as t can be expressed in terms of τ by expanding the logarithm, we can by the ordinary process of reversion of series expand τ in terms of t .

Let
$$\tau = A_1 \frac{t}{1!} + A_2 \frac{t^2}{2!} + A_3 \frac{t^3}{3!} + \dots$$

Then, differentiating equation (2),

$$\tau \frac{d\tau}{dt} = t(1+\tau); \dots\dots\dots(3)$$

whence, by substituting the series for τ and equating coefficients, we can readily obtain the values of A_1, A_2, A_3 , etc.

$$\begin{aligned} \text{Now } \frac{\Gamma(n+1)}{n^n e^{-n}} &= \int_{-\infty}^{\infty} e^{-\frac{n}{2}t^2} \frac{dx}{dt} dt = n \int_{-\infty}^{\infty} e^{-\frac{n}{2}t^2} \frac{d\tau}{dt} dt \\ &= n \int_{-\infty}^{\infty} e^{-\frac{n}{2}t^2} \left[A_1 + A_2 \frac{t}{1!} + A_3 \frac{t^2}{2!} + A_4 \frac{t^3}{3!} + \dots \right] dt \end{aligned}$$

$$\text{and } \int_{-\infty}^{\infty} t^{2p} e^{-\kappa t^2} dt = \frac{1 \cdot 3 \cdot 5 \dots (2p-1)}{2^p \kappa^{2p+1}} \sqrt{\pi},$$

by writing κt for x in the result of Art. 223, Ex. 4,

$$\begin{aligned} &\frac{\Gamma\left(\frac{2p+1}{2}\right)}{\kappa^{2p+1}}, \end{aligned}$$

$$\text{and } \int_{-\infty}^{\infty} t^{2p+1} e^{-\kappa t^2} dt = 0,$$

as is obvious, for the negative elements of the summation cancel out the positive ones.

Hence

$$\begin{aligned} \frac{\Gamma(n+1)}{n^n e^{-n}} &= n \left\{ A_1 \frac{\Gamma\left(\frac{1}{2}\right)}{\left(\frac{n}{2}\right)^{\frac{1}{2}}} + \frac{A_3}{2!} \frac{\Gamma\left(\frac{3}{2}\right)}{\left(\frac{n}{2}\right)^{\frac{3}{2}}} + \frac{A_5}{4!} \frac{\Gamma\left(\frac{5}{2}\right)}{\left(\frac{n}{2}\right)^{\frac{5}{2}}} + \text{etc.} \right\} \\ &= \sqrt{2n\pi} \left[A_1 + \frac{1}{2} \cdot \frac{2}{n} \cdot \frac{A_3}{2!} + \frac{1}{2} \cdot \frac{3}{2} \cdot \left(\frac{2}{n}\right)^2 \frac{A_5}{4!} + \dots \right], \end{aligned}$$

and it remains to obtain the numerical values of the coefficients.

Substituting the series for τ in the differential equation (3),

$$\begin{aligned} \left(A_1 \frac{t}{1!} + A_2 \frac{t^2}{2!} + A_3 \frac{t^3}{3!} + A_4 \frac{t^4}{4!} + \dots \right) \times \left(A_1 + A_2 \frac{t}{1!} + A_3 \frac{t^2}{2!} + \dots \right) \\ \equiv t \left(1 + A_1 \frac{t}{1!} + A_2 \frac{t^2}{2!} + A_3 \frac{t^3}{3!} + \dots \right); \end{aligned}$$

$$\text{whence } \frac{A_1}{1!} A_1 = 1,$$

$$\frac{A_1}{1!} \frac{A_2}{1!} + \frac{A_2}{2!} A_1 = \frac{A_1}{1!},$$

$$\frac{A_1}{1!} \frac{A_3}{2!} + \frac{A_2}{2!} \frac{A_2}{1!} + \frac{A_3}{3!} A_1 = \frac{A_2}{2!},$$

and generally

$$\frac{A_1}{1!} \frac{A_n}{(n-1)!} + \frac{A_2}{2!} \frac{A_{n-1}}{(n-2)!} + \frac{A_3}{3!} \frac{A_{n-2}}{(n-3)!} + \dots + \frac{A_n}{n!} A_1 = \frac{A_{n-1}}{(n-1)!},$$

$$i.e. \quad nA_1A_n + \frac{n(n-1)}{1 \cdot 2} A_2A_{n-1} + \frac{n(n-1)(n-2)}{1 \cdot 2 \cdot 3} A_3A_{n-2} \\ + \dots + A_nA_1 = nA_{n-1},$$

$$i.e. \quad (n+1)A_1A_n + \frac{(n+1)n}{1 \cdot 2} A_2A_{n-1} + \frac{(n+1)n(n-1)}{1 \cdot 2 \cdot 3} A_3A_{n-2} \\ + \dots = nA_{n-1},$$

the series proceeding as far as the greatest binomial coefficient in $(1+z)^{n+1}$, and the last term of the series being halved if n be odd.

Thus

$$A_1 = 1, \\ 3A_1A_2 = 2A_1, \\ 4A_1A_3 + 3A_2^2 = 3A_2, \\ 5A_1A_4 + 10A_2A_3 = 4A_3, \\ 6A_1A_5 + 15A_2A_4 + 10A_3^2 = 5A_4, \\ 7A_1A_6 + 21A_2A_5 + 35A_3A_4 = 6A_5, \\ 8A_1A_7 + 28A_2A_6 + 56A_3A_5 + 35A_4^2 = 7A_6, \\ \text{etc.,}$$

$$\text{giving } A_1 = 1, \quad A_2 = \frac{2}{3}, \quad A_3 = \frac{1}{6}, \quad A_4 = -\frac{4}{45}, \quad A_5 = \frac{1}{36}, \\ A_6 = \frac{1}{80}, \quad A_7 = -\frac{1}{600}, \quad A_8 = \frac{1}{81}, \quad A_9 = -\frac{5}{864}, \quad \text{etc.}$$

Hence, finally,

$$\Gamma(n+1) = \sqrt{2n\pi} n^n e^{-n} \left[1 + \frac{1}{12} \frac{1}{n} + \frac{1}{288} \frac{1}{n^2} + \dots \right].$$

When n is indefinitely large, we therefore have

$$\Gamma(n+1) = \sqrt{2n\pi} n^n e^{-n},$$

which removes the limitation that n should be a positive integer, as supposed in Art. 877. Moreover, it will be noted that

an expansion of $\frac{\Gamma(n+1)}{\sqrt{2n\pi} n^n e^{-n}}$ is effected in powers of $\frac{1}{n}$, viz.

$$\frac{\Gamma(n+1)}{\sqrt{2n\pi} n^n e^{-n}} = 1 + \frac{1}{12} \frac{1}{n} + \frac{1}{288} \frac{1}{n^2} - \frac{139}{51840} \frac{1}{n^3} - \dots + \frac{A_{2p+1}}{2^p p!} \frac{1}{n^p} + \dots,$$

the law of formation of A_{2p+1} being as above stated.

885. Ex. 1. In calculating $10!$ in this way,

$$\log \sqrt{2\pi} \cdot 10 \cdot 10^{10} e^{-10} = 6.3561451 \text{ (Chambers' seven-figure logarithms);}$$

$$\therefore \sqrt{2\pi} \cdot 10 \cdot 10^{10} e^{-10} = 3598695 \text{ (the last figure doubtful).}$$

Carrying the series to four terms, viz.

$$1 + \frac{1}{120} + \frac{1}{28800} - \frac{139}{51840000} \equiv 1.00836537,$$

we get

$$10! = 3598695 \times 1.00836537 = 3628799 \text{ etc.}$$

The true value is 3628800, so there is only an error in the last figure in the approximation.

Ex. 2. Calculate $100!$ Here

$$\begin{aligned}\log(100!) &= \log\{\sqrt{2\pi} \cdot 100 \cdot 100^{100} e^{-100} (1 + \frac{1}{12 \cdot 100} + \frac{1}{288 \cdot 100^2} - \dots)\} \\ &= 157.9700036,\end{aligned}$$

indicating a number of 158 figures, beginning with 933262, viz. 9.33262×10^{157} .

[The logarithms from 1 to 100 add up to 157.9700038, which is in agreement with this result, except for the seventh figure of logarithms.]

886. Properties of Gauss' Π Function.

We may now proceed to discuss the nature and properties of Gauss' Π function.

Let us start again with a consideration of the expression

$$\Pi(x, \mu) = \frac{1 \cdot 2 \cdot 3 \dots \mu}{(x+1)(x+2)(x+3)\dots(x+\mu)} \mu^x,$$

where μ is a positive integer, not necessarily large, at present, and x is a fixed number, either real or unreal, positive or negative, integral or fractional, but finite. Call the expression $\Pi(x, \mu)$, and abbreviate it further into $\Pi(x)$ when in the limit μ is ∞ , so that $\Pi(x)$ stands for $\Pi(x, \infty)$.

Consider the graphs of

$$y = \frac{1 \cdot 2 \cdot 3 \dots \mu}{(x+1)(x+2)\dots(x+\mu)} \mu^x$$

for different values of μ .

There are μ asymptotes parallel to the y -axis.

y is positive from $x = \infty$ to $x = -1$,

negative from $x = -1$ to $x = -2$,

positive from $x = -2$ to $x = -3$,

and so on.

And if μ be > 1 , the x -axis is an asymptote at its negative extremity only;

also when $x=0$, $y=1$;

when $x=1$, $y = \frac{\mu}{\mu+1}$;

when $x=2$, $y = \frac{1 \cdot 2 \mu^2}{(\mu+1)(\mu+2)}$;

etc.;

and these ordinates approximate to $1, 1, 2!, 3!, \dots$ as μ increases, whilst at the same time the number of asymptotes increases.

The cases of $\mu=1, 2, 3$ and 4 are shown in the accompanying figures, which are intended to exhibit graphically the general characteristics of the functions, but are not drawn to scale.

The case $\mu=1$ gives $y = \frac{1}{x+1}$, a rectangular hyperbola, with $y=0, x=-1$ for asymptotes.

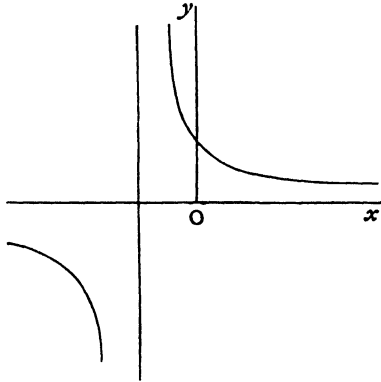

Fig. 316.

The case $\mu=2$ gives $y = \frac{1 \cdot 2}{(x+1)(x+2)} 2^x$.

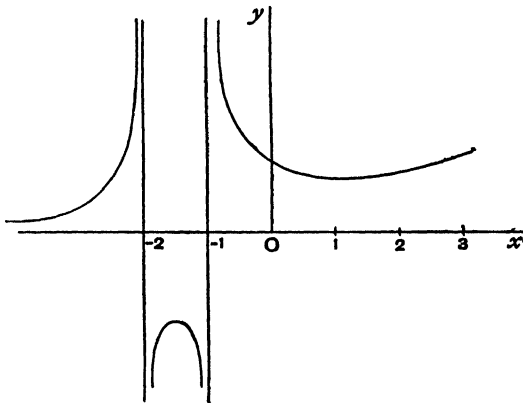

Fig. 317.

The case $\mu=3$ gives $y = \frac{1 \cdot 2 \cdot 3}{(x+1)(x+2)(x+3)} 3^x$.

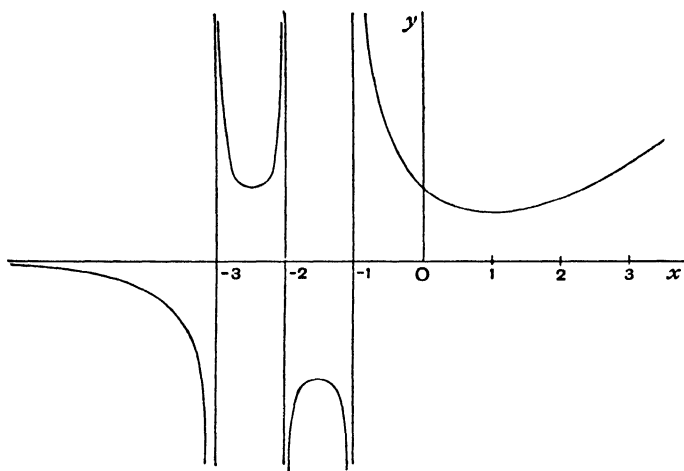

Fig. 318.

The case $\mu=4$ gives $y = \frac{1 \cdot 2 \cdot 3 \cdot 4}{(x+1)(x+2)(x+3)(x+4)} 4^x$.

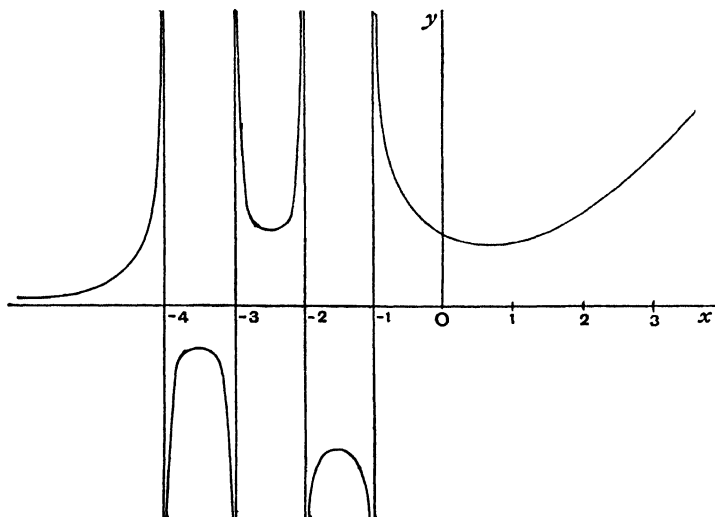

Fig. 319.

The lengths of the ordinates for various values of x and μ are shown in the table :

	$x=5$	$x=4$	$x=3$	$x=2$	$x=1$	$x=\frac{1}{2}$	$x=0$
$\mu=1$	0.167	0.200	0.250	0.333	0.500	0.667	1
$\mu=2$	1.524	1.067	0.800	0.667	0.667	0.754	1
$\mu=3$	4.339	2.314	1.350	0.900	0.750	0.792	1
$\mu=4$	8.127	3.657	1.829	1.067	0.800	0.813	1
..
$\mu=\infty$	120	24	6	2	1	0.886	1

	$x=-\frac{1}{2}$	$x=-1$	$x=-\frac{3}{2}$	$x=-2$	$x=-\frac{5}{2}$	$x=-3$	$x=-\frac{7}{2}$	$x=-4$
$\mu=1$	2	∞	-2	-1	-0.667	-0.500	-0.400	-0.333
$\mu=2$	1.886	∞	-2.828	∞	+0.471	0.125	0.047	0.021
$\mu=3$	1.847	∞	-3.079	∞	+1.026	∞	-0.068	-0.012
$\mu=4$	1.829	∞	-3.200	∞	+1.333	∞	-0.200	∞
.
$\mu=\infty$	1.772	∞	-3.545	∞	2.363	∞	-0.945	∞

887. **General Remarks.**

From these considerations it will appear that in these curves, viz. $\mu=2, \mu=3, \mu=4$, etc.,

(1) At $x=0$ all the ordinates are =1, and any two of the curves cross each other.

(2) At $x=\frac{1}{2}, 1, 2, 3, 4, \dots$ the ordinates of the several curves form an increasing series, so that the curves as μ increases are such that of any two the one with the greater μ has the greater ordinate.

(3) As x increases through zero the curves are all initially approaching the x -axis. The limiting case of the hyperbola $y = \frac{1}{x+1}$ continues to do so, the others all ultimately have

ordinates > 1 , and therefore have minimum ordinates in the first quadrant. Moreover it may be shown that

$\mu=2$	has a minimum ordinate between 1	and 2,
$\mu=3$	"	" " 0.9 and 1,
$\mu=4$	"	" " 0.7 and 0.8,
		etc.

As μ increases, the minimum ordinate begins to approach the y -axis, but does not do so without limit. For in the case $\mu = \infty$ it lies somewhere between 0 and 1.

(4) On the negative side of the y -axis at $x = -\frac{1}{2}$ the successive ordinates of the curves $\mu=1$, $\mu=2$, $\mu=3$, etc., form a diminishing set.

- (5) $\mu=1$ has one asymptote parallel to the y -axis,
 $\mu=2$ has two asymptotes parallel to the y -axis,
 $\mu=3$ has three asymptotes parallel to the y -axis,
 etc.

$\mu=1$ is asymptotic to the x -axis at both ends.

$\mu=2$, $\mu=3$, $\mu=4$, etc., are only asymptotic to the x -axis at its negative end, and alternately from above and below the x -axis.

- (6) Observe the behaviour between the several asymptotes.

Between $x = -1$ and $x = -2$ the several ordinates at $x = -\frac{3}{2}$ are all negative but numerically increasing, *i.e.* the more asymptotes there are the further do these branches recede from the x -axis. Similarly between the asymptotes $x = -2$ and $x = -3$, or any consecutive pair.

Note also that for each given value of μ the branch between two consecutive asymptotes has a numerically greater ordinate midway between those asymptotes than is the case for a branch between two consecutive asymptotes more remote from the y -axis.

- (7) The limiting case

$$y = \lim_{\mu \rightarrow \infty} \frac{1 \cdot 2 \dots \mu}{(x+1)(x+2) \dots (x+\mu)} \mu^x, \text{ viz. } y = \Pi(x)$$

becomes, when x is positive, the curve $y = \Gamma(x+1)$, as has been shown.

The shape of this limiting form will be more carefully considered later in Art. 922.

But there is this difference between the functions

$$Lt_{\mu=\infty} \frac{1 \cdot 2 \dots \mu}{(x+1)(x+2) \dots (x+\mu)} \mu^x \quad \text{and} \quad \int_0^{\infty} e^{-v} v^x dv,$$

that though they coincide in value for all positive values of x , the former becomes infinite at the values $x=-1$, $x=-2$, $x=-3$, etc, but has finite values for other negative values of x , whilst the definite integral is permanently infinite for all negative values of $x+1$.

888. That the factor form has finite values, when μ becomes infinitely large, for negative values of x between the asymptotes may be made clear by taking a case. Take $x = -\frac{3}{2}$.

$$\begin{aligned} \text{Then } Lt_{\mu=\infty} & \frac{1 \cdot 2 \cdot 3 \dots \mu}{\left(-\frac{1}{2}\right)\left(\frac{1}{2}\right)\left(\frac{3}{2}\right) \dots \left(\frac{2\mu-3}{2}\right)} \mu^{-\frac{3}{2}} \\ & = -Lt \frac{2 \cdot 4 \cdot 6 \dots 2\mu}{1 \cdot 1 \cdot 3 \cdot 5 \dots (2\mu-3)} \frac{1}{\mu^{\frac{3}{2}}} \\ & = -Lt \frac{2^2 \cdot 4^2 \cdot 6^2 \dots (2\mu)^2}{1 \cdot 2 \cdot 3 \cdot 4 \dots (2\mu-3)(2\mu-2)(2\mu-1)(2\mu)} \frac{(2\mu-1)}{\mu^{\frac{3}{2}}} \\ & = -Lt 2^{2\mu} \frac{(\sqrt{2\mu\pi} \mu^{\mu} e^{-\mu})^2}{\sqrt{4\mu\pi} (2\mu)^{2\mu} e^{-2\mu}} \frac{(2\mu-1)}{\mu^{\frac{3}{2}}} \\ & = -Lt \frac{2\pi\mu}{2\sqrt{\pi\mu}} \frac{2\mu-1}{\mu^{\frac{3}{2}}} = -\frac{2}{1} \sqrt{\pi}. \end{aligned}$$

Similarly at $x = -\frac{5}{2}$ the corresponding limit is $\frac{2^2}{1 \cdot 3} \sqrt{\pi}$,

at $x = -\frac{7}{2}$ the corresponding limit is $-\frac{2^3}{1 \cdot 3 \cdot 5} \sqrt{\pi}$,

and so on.

These mid-ordinates, half way between the successive asymptotes, thus form a regular descending series

$$-\frac{2}{1} \sqrt{\pi}, \quad \frac{2^2}{1 \cdot 3} \sqrt{\pi}, \quad -\frac{2^3}{1 \cdot 3 \cdot 5} \sqrt{\pi}, \quad \frac{2^4}{1 \cdot 3 \cdot 5 \cdot 7} \sqrt{\pi}, \quad \text{etc.}$$

889. It is worth noticing that $\Pi(x, \mu)$ may be written as

$$\begin{aligned} \Pi(x, \mu) & \equiv \frac{1 \cdot 2 \cdot 3 \dots \mu}{(x+1)(x+2)(x+3) \dots (x+\mu)} \mu^x \\ & \equiv \frac{\left(\frac{2}{1}\right)^x \left(\frac{3}{2}\right)^x \left(\frac{4}{3}\right)^x \dots \left(\frac{\mu}{\mu-1}\right)^x \left(\frac{\mu+1}{\mu}\right)^x}{\left(1+\frac{x}{1}\right) \left(1+\frac{x}{2}\right) \left(1+\frac{x}{3}\right) \dots \left(1+\frac{x}{\mu}\right)} \left(\frac{\mu}{\mu+1}\right)^x \end{aligned}$$

$$\begin{aligned}
&= \frac{\left(1 + \frac{1}{1}\right)^x \left(1 + \frac{1}{2}\right)^x \left(1 + \frac{1}{3}\right)^x \cdots \left(1 + \frac{1}{\mu}\right)^x}{\left(1 + \frac{x}{1}\right) \left(1 + \frac{x}{2}\right) \left(1 + \frac{x}{3}\right) \cdots \left(1 + \frac{x}{\mu}\right)} \left(\frac{\mu}{\mu+1}\right)^x \\
&= \left(\frac{\mu}{\mu+1}\right)^x \prod_{r=1}^{r=\mu} \frac{\left(1 + \frac{1}{r}\right)^x}{\left(1 + \frac{x}{r}\right)},
\end{aligned}$$

where $\prod_{r=1}^{r=\mu}$ indicates that the product of all such fractions as follow it is to be taken from $r=1$ to $r=\mu$.

And in the limit, when $\mu = \infty$,

$$\Pi(x) = \prod_{r=1}^{r=\infty} \frac{\left(1 + \frac{1}{r}\right)^x}{1 + \frac{x}{r}},$$

or, what is the same thing, when x is real and positive,

$$\Gamma(1+x) = \prod_{r=1}^{r=\infty} \frac{\left(1 + \frac{1}{r}\right)^x}{\left(1 + \frac{x}{r}\right)}.$$

890. Reduction of $\Pi(x+1)$.

Again,

$$\begin{aligned}
\Pi(x+1, \mu) &= \frac{1 \cdot 2 \cdot 3 \cdots \mu}{(x+2)(x+3)(x+4) \cdots (x+\mu)(x+\mu+1)} \mu^{x+1} \\
&= \mu \frac{x+1}{x+\mu+1} \Pi(x, \mu).
\end{aligned}$$

Hence

$$\Pi(x+1, \mu) = (x+1) \Pi(x, \mu) \times \frac{1}{1 + \frac{\mu}{x+1}},$$

which is the law of connexion of the successive values of $\Pi(x, \mu)$ for unit differences in x .

In the case when μ is indefinitely increased, the factor

$$\left(1 + \frac{x+1}{\mu}\right)^{-1}$$

becomes unity, and we are left with $\Pi(x+1) = (x+1)\Pi(x)$

and changing x to $x-1$, $\Pi(x)=x\Pi(x-1)$. This is true for all finite values of x , positive or negative.

In the case of values of $x > 0$ we have $\Pi(x)=\Gamma(x+1)$, and therefore $\Gamma(x+1)=x\Gamma(x)$, the formula already established for the Gamma function.

891. The Case when x is a Positive Integer.

When x is a positive integer we may multiply the numerator and denominator of

$$\Pi(x, \mu) \equiv \frac{1 \cdot 2 \dots \mu}{(x+1)(x+2) \dots (x+\mu)} \mu^x \text{ by } x!$$

obtaining in that case $\Pi(x, \mu) = \frac{x! \mu!}{(x+\mu)!} \mu^x$,

and then removing $\mu!$,

$$\begin{aligned} \Pi(x, \mu) &= \frac{1 \cdot 2 \dots x}{(\mu+1)(\mu+2) \dots (\mu+x)} \mu^x \\ &= \frac{1 \cdot 2 \dots x}{\left(1+\frac{1}{\mu}\right)\left(1+\frac{2}{\mu}\right) \dots \left(1+\frac{x}{\mu}\right)}, \end{aligned}$$

so that when μ is indefinitely increased, x remaining finite, $\Pi(x)$ becomes $x!$, which is in accordance with the result $\Gamma(x+1)=x!$ of Art. 860.

892. Comparison of the Gamma Function with Gauss' Function.

It will now be clear, from Art. 887, that the two functions $\Pi(x)$ and $\Gamma(x+1)$ are identical for all real values of x greater than -1 ; but that $\Pi(x)$ is a more general function, embracing real or unreal values of x quite unrestricted as to sign. That $\Pi(x)$ becomes infinite for all negative integral values of x , but has finite values for negative fractional values of x , whilst $\Gamma(x)$ defined as $\int_0^\infty e^{-v} v^{x-1} dv$ is infinite for all negative values of x .

Graphically this means that the curves $y=\Pi(x-1)$ and $y=\Gamma(x)$ absolutely coincide for all positive values of x , but do not do so for negative values of x . If we had restricted the definition of Gauss' function, viz.

$$Lt_{\mu=\infty} \Pi(x, \mu) \equiv Lt_{\mu=\infty} \frac{1 \cdot 2 \cdot 3 \dots \mu}{(x+1)(x+2) \dots (x+\mu)} \mu^x,$$

to real values of x greater than -1 , the identity of $\Pi(x)$ with Euler's Gamma function $\Gamma(x+1)$ would have been complete.

893. We have, from the definition,

$$\Pi(-x, \mu) \equiv \frac{1 \cdot 2 \cdot 3 \dots (\mu-1) \mu}{(1-x)(2-x)(3-x) \dots (\mu-1-x)(\mu-x)} \mu^{-x}$$

$$\text{and } \Pi(x-1, \mu) \equiv \frac{1 \cdot 2 \cdot 3 \dots (\mu-1) \mu}{x(x+1)(x+2) \dots (x+\mu-1)} \mu^{x-1}.$$

Hence multiplying them together, and assuming that x is not an integer,

$$\begin{aligned} & \Pi(-x, \mu) \Pi(x-1, \mu) \\ &= \frac{1}{x} \cdot \frac{1^2 \cdot 2^2 \cdot 3^2 \dots (\mu-1)^2}{(1^2-x^2)(2^2-x^2)(3^2-x^2) \dots \{(\mu-1)^2-x^2\}} \frac{\mu}{\mu-x} \\ &= \frac{1}{x \left(1-\frac{x^2}{1^2}\right) \left(1-\frac{x^2}{2^2}\right) \dots \left\{1-\frac{x^2}{(\mu-1)^2}\right\}} \frac{\mu}{\mu-x}; \end{aligned}$$

and when μ increases without limit, $lt \frac{\mu}{\mu-x} = 1$, x being finite, and we have

$$\Pi(-x) \Pi(x-1) = \frac{1}{x \left(1-\frac{x^2}{1^2}\right) \left(1-\frac{x^2}{2^2}\right) \dots \text{to } \infty} = \frac{\pi}{\sin \pi x}.$$

It will be noticed that in proving this result no assumption has been made with regard to x except that it is not to be an integer, either positive or negative. For such values one or other of the Π functions would be infinite, as also of course would $\frac{\pi}{\sin \pi x}$.

Taking positive values of x less than unity, and remembering that in that case $\Pi(x) = \Gamma(x+1)$, we have

$$\Gamma(1-x) \Gamma(x) = \frac{\pi}{\sin \pi x},$$

as previously found.

894. If we were to base the discussion of the properties of $\Gamma(x)$ on this method of procedure, we could therefore infer the value of the definite integral $\int_0^1 \frac{v^{x-1}}{1+v} dv$ of Art. 870 to be $\frac{\pi}{\sin \pi x}$, where $0 < x < 1$, instead of investigating the integral first and then deducing the result $\Gamma(1-x) \Gamma(x) = \frac{\pi}{\sin \pi x}$.

895. **An Unreal Value of x .**

We note also that if x be unreal and $=iy$,

$$i\Pi(-iy)\Pi(iy-1) = \frac{\pi}{\sinh \pi y};$$

but that Γ , as defined in the Eulerian manner, loses its meaning.

See, however, Art. 900 for an extension of the definition of Γ .

896. Both functions, viz. $\Pi(x)$ and $\Gamma(x+1)$, have been shown to satisfy the equation of differences

$$u_{x+1} = (x+1)u_x.$$

Let us see from this point of view what can be ascertained as to the nature of the function u_x .

It has already been stated that this equation necessitates one form of the result to be

$$u_x = Ax(x-1)(x-2)\dots(r+1)ru_r,$$

where A is a constant or some arbitrary periodic function of x of unit periodicity, and u_r is some initial value of u_x to be chosen at pleasure.

Following Laplace's mode of procedure in such cases, assume as a trial solution,

$$u_x = \int t^x F'(t) dt, *$$

where the form of $F(t)$ and the limits of integration are reserved for future choice.

Then, since $u_{x+1} = (x+1)u_x$,

$$\begin{aligned} \int t^{x+1} F'(t) dt &= (x+1) \int t^x F'(t) dt \\ &= \int F'(t) (x+1) t^x dt \\ &= [F(t) t^{x+1}] - \int t^{x+1} F''(t) dt, \end{aligned}$$

the integration being by parts, and the square brackets denoting as usual that the term integrated is to be taken between the limits ultimately chosen.

Hence the choice must be such as to satisfy the equation

$$\int t^{x+1} [F(t) + F''(t)] dt = [F(t) t^{x+1}].$$

* See Boole, *Finite Differences*, p. 257.

Let us then take $F(t)$ so that $F'(t)+F(t)=0$, and the limits such that $[F(t)t^{x+1}]=0$.

Our choice is now complete, and there is no further latitude.

The first equation gives $\frac{F'(t)}{F(t)} = -1$, *i.e.* $F(t) = Ce^{-t}$, where C is an arbitrary constant as regards t .

This determines the form of the function F in our trial solution.

The limits must then be such as will satisfy the equation

$$[Ce^{-t}t^{x+1}] = 0.$$

Supposing $x+1$ to be positive, this will be effected by taking $t=0$ and $t=\infty$, for in each case $Lt \frac{t^{x+1}}{e^t} = 0$.

Hence a solution of the equation for positive values of $x+1$ is

$$\begin{aligned} u_x &= C \int_0^\infty e^{-t} t^x dt \\ &= C\Gamma(x+1). \end{aligned}$$

So $u_x = C\Gamma(x+1)$ is a solution, provided $x+1$ be positive where C is any arbitrary constant *as regards* t .

To put the possible dependence upon x in evidence call C, v_x .

$$\text{Then} \quad u_x = v_x \Gamma(x+1),$$

$$u_{x+1} = v_{x+1} \Gamma(x+2) = v_{x+1} (x+1) \Gamma(x+1),$$

$$\text{but} \quad u_{x+1} = (x+1) u_x;$$

$$\therefore v_{x+1} = v_x,$$

whence it is clear that v_x is either an absolute constant or some arbitrary periodic function of x whose periodicity is unity, such as $\cos^n 2\pi x$ or $\frac{A+B \cos^p 2\pi x}{C+D \sin^p 2\pi x}$ where A, B, C, D are absolute constants, such functions returning to their original values when x is increased by unity.

Thus $u_x = f(x)\Gamma(x+1)$ satisfies the difference equation considered when $f(x)$ is such a periodic function as described.

It appears, therefore, that the equation $u_{x+1} = (x+1)u_x$ is not co-equivalent with $u_x = \Gamma(x+1)$, *i.e.* Euler's Gamma function, or with $u_x = \Pi(x)$, *i.e.* Gauss' Π function, but that

these are particular forms of the solution, as has been previously pointed out.

897. Euler's Constant.

The limiting value when n is made infinitely great of

$$\frac{1}{1} + \frac{1}{2} + \frac{1}{3} + \dots + \frac{1}{n} - \log n$$

is finite, positive and less than unity. This limit plays an important part in our subsequent work. It is called Euler's constant and denoted by γ . Its value has been computed to over 100 places of decimals (*Proc. Royal Society*, vol. xix. and vol. xx., p. 29).

The first twenty figures are*

$$\gamma = 0.577\ 215\ 664\ 901\ 532\ 860\ 60\dots$$

We shall presently show how it is to be computed. For the present it is sufficient to show that it is a positive proper fraction, and this admits of elementary proof.

For

$$\begin{aligned} \frac{1}{r} + \log \frac{r}{r+1} &= \frac{1}{r} - \log \left(1 + \frac{1}{r} \right) \\ &= \frac{1}{2r^2} - \frac{1}{3r^3} + \frac{1}{4r^4} - \frac{1}{5r^5} + \dots, \text{ a convergent series if } r \geq 1, \\ &= \frac{1}{r^2} \left(\frac{1}{2} - \frac{1}{3r} \right) + \frac{1}{r^4} \left(\frac{1}{4} - \frac{1}{5r} \right) + \dots \\ &= \text{positive, since } r \geq 1, \text{ for every bracket is positive;} \\ \therefore \left(\frac{1}{1} + \log \frac{1}{2} \right) + \left(\frac{1}{2} + \log \frac{2}{3} \right) + \dots + \left(\frac{1}{n} + \log \frac{n}{n+1} \right) &\text{ is positive;} \\ \therefore \frac{1}{1} + \frac{1}{2} + \frac{1}{3} + \dots + \frac{1}{n} + \log \frac{1}{2} \cdot \frac{2}{3} \cdot \frac{3}{4} \dots \frac{n}{n+1} &\text{ is positive;} \\ \therefore \frac{1}{1} + \frac{1}{2} + \frac{1}{3} + \dots + \frac{1}{n} - \log(n+1) &\text{ is positive;} \end{aligned}$$

and as

$$\log(n+1) > \log n,$$

$$\frac{1}{1} + \frac{1}{2} + \frac{1}{3} + \dots + \frac{1}{n} - \log n \text{ is positive.}$$

* See Todhunter, *Integral Calculus*, p. 256; Serret, *Calc. Integral*, p. 183; Legendre, *Exercices*, p. 295; De Morgan, *D. and I. Calculus*, p. 578.

Secondly,

$$\frac{1}{r} + \log \frac{r-1}{r} = \frac{1}{r} + \log \left(1 - \frac{1}{r}\right)$$

$$= -\frac{1}{2r^2} - \frac{1}{3r^3} - \text{etc.}, \text{ a convergent series if } r > 1 :$$

$$\therefore \sum_2^n \left(\frac{1}{r} + \log \frac{r-1}{r} \right) = -\frac{1}{2} \sum_2^n \frac{1}{r^2} - \frac{1}{3} \sum_2^n \frac{1}{r^3} - \dots, \left\{ \begin{array}{l} \text{which, when } n = \infty, \\ \text{are all convergent} \\ \text{series,} \end{array} \right.$$

$$= \text{a negative quantity.}$$

Therefore

$$\frac{1}{2} + \frac{1}{3} + \frac{1}{4} + \dots + \frac{1}{n} + \log \frac{1}{2} \cdot \frac{2}{3} \cdot \frac{3}{4} \dots \frac{n-1}{n} \text{ is a negative quantity,}$$

i.e. $\frac{1}{2} + \frac{1}{3} + \frac{1}{4} + \dots + \frac{1}{n} - \log n$ is a negative quantity,

and $\therefore 1 + \frac{1}{2} + \frac{1}{3} + \dots + \frac{1}{n} - \log n$ is less than 1,

and it has been shown to be positive.

Hence, making n increase indefinitely, γ is a positive proper fraction.

898. Closer Limits for γ .

Let $u_n = \sum_1^n r^{-1} - \log(n+1), \quad v_n = \sum_1^n r^{-1} - \log n \quad (n > 1).$

Then $v_n - u_n = \log \left(1 + \frac{1}{n}\right)$ = positive, if n be finite, and ultimately vanishing when $n = \infty$, i.e. $u_\infty = v_\infty = \gamma$.

Now $u_n - u_{n-1} = \frac{1}{n} + \log \frac{n}{n+1}$ = positive; $v_n - v_{n-1} = \frac{1}{n} + \log \frac{n-1}{n}$ = negative; therefore, as n increases, u_n increases and v_n decreases towards the common limit γ ; and $u_n < \gamma < v_n$, whilst n remains finite.

Taking Bottonley's tables of Reciprocals and Napierian Logarithms, we readily find

$$u_1 = \cdot 3069, \quad u_2 = \cdot 4014, \quad \dots \quad u_{10} = \cdot 5311, \quad u_{20} = \cdot 5532, \quad u_{30} = \cdot 5610, \quad \text{etc.}$$

$$v_1 = 1\cdot 0000, \quad v_2 = \cdot 8069, \quad \dots \quad v_{10} = \cdot 6264, \quad v_{20} = \cdot 6020, \quad v_{30} = \cdot 5938, \quad \text{etc.}$$

We thus have an approaching set of inferior and superior limits for γ , and note that it must lie between 0·56 and 0·60. It will be seen later that $\gamma = 0\cdot 5772\dots$ (Art. 917).

899. Except for negative integral values of z , $\Pi(z)$ is Finite whatever z may be, Real or Complex.

If $u_1, u_2, u_3, \dots u_n \dots$ be any series of real positive quantities, each of which is less than unity, the infinite products $\prod_{r=1}^{\infty} (1 + u_r)$, $\prod_{r=1}^{\infty} (1 - u_r)$ are convergent or divergent according as the infinite

series $\sum u_r$ is convergent or divergent (see Smith's *Algebra*, p. 423,* and Hobson's *Trigonometry*, p. 319), and if the quantities $u_1, u_2, \dots u_n \dots$ be complex quantities, the modulus of each being less than unity, the product $\prod_{r=1}^{\infty} (1+u_r)$ converges if the series $\sum \text{mod } u_r$ converges. (See Hobson's *Trigonometry*, p. 320.)

It can be shown that though the infinite product

$$\prod_1^{\infty} \left(1 + \frac{z}{n}\right), \quad \text{i.e.} \quad \left(1 + \frac{z}{1}\right) \left(1 + \frac{z}{2}\right) \left(1 + \frac{z}{3}\right) \left(1 + \frac{z}{4}\right) \dots \text{ to infinity,}$$

which occurs frequently in the present chapter, is obviously divergent, yet if we multiply the several factors by

$$e^{-\frac{z}{1}}, \quad e^{-\frac{z}{2}}, \quad e^{-\frac{z}{3}}, \quad \text{etc., respectively,} \dagger$$

we arrive at a product

$$\prod_1^{\infty} \left[\left(1 + \frac{z}{n}\right) e^{-\frac{z}{n}} \right],$$

which is absolutely convergent for all values of z positive or negative, real or complex.

$$\text{For} \quad \log \left(1 + \frac{z}{n}\right) = \frac{z}{n} - \frac{z^2}{2n^2} + \frac{z^3}{3n^3} - \dots$$

is a series absolutely convergent if $\text{mod } z < n$ for some finite value of n ; whence

$$\begin{aligned} e^{-\frac{z}{n}} &= e^{-\log \left(1 + \frac{z}{n}\right)} e^{-\frac{z^2}{2n^2} + \frac{z^3}{3n^3} - \dots} \\ &= \frac{1}{1 + \frac{z}{n}} e^{-\frac{z^2}{2n^2} + \frac{z^3}{3n^3} - \dots}, \end{aligned}$$

$$\begin{aligned} \text{i.e.} \quad \left(1 + \frac{z}{n}\right) e^{-\frac{z}{n}} &= e^{-\frac{z^2}{2n^2} (1 + \dots)} \\ &= 1 - \frac{z^2}{2n^2} (1 + \epsilon_n), \text{ say,} \end{aligned}$$

where ϵ_n is a series absolutely convergent which for finite values of z ultimately vanishes when n is infinitely large;

$$\therefore \prod_1^{\infty} \left(1 + \frac{z}{n}\right) e^{-\frac{z}{n}} = \prod_1^{\infty} \left[1 - \frac{z^2}{2n^2} (1 + \epsilon_n) \right].$$

* Also see Arndt, *Grunert*, xxi. 78.

† Weierstrass, *Abhandlungen Acad. of Berlin*, 1876. See also Hobson, *Trigonometry*, p. 327.

Suppose E the greatest of the moduli of $1 + \epsilon_n$ for all values of z within a range for which the greatest modulus of z does not exceed a given finite quantity, then $\sum_1^{\infty} \text{mod } \frac{Ez^2}{2n^2}$ is an absolutely convergent series, and therefore also $\sum_1^{\infty} \frac{z^2}{2n^2} (1 + \epsilon_n)$ is an absolutely convergent series, and since $\prod_1^{\infty} (1 + u_n)$ is absolutely convergent when $\sum \text{mod } u_n$ is convergent,

$$\prod_1^{\infty} \left(1 + \frac{z}{n}\right) e^{-\frac{z}{n}}$$

is an absolutely convergent product, as is also

$$\prod_1^{\infty} \left(1 - \frac{z}{n}\right) e^{\frac{z}{n}}.$$

Now Gauss' Π function being defined as

$$\Pi(z) = Lt_{\mu=\infty} \frac{1 \cdot 2 \cdot 3 \dots \mu}{(z+1)(z+2)(z+3) \dots (z+\mu)} \mu^z$$

$$\begin{aligned} \text{can be written} &= Lt_{\mu=\infty} \frac{\mu^z}{\left(1 + \frac{z}{1}\right) \left(1 + \frac{z}{2}\right) \left(1 + \frac{z}{3}\right) \dots \left(1 + \frac{z}{\mu}\right)} \\ &= Lt_{\mu=\infty} \frac{e^{z \left(\log \mu - \frac{1}{1} - \frac{1}{2} - \frac{1}{3} - \dots - \frac{1}{\mu}\right)}}{\prod_1^{\infty} \left(1 + \frac{z}{\mu}\right) e^{-\frac{z}{\mu}}} \\ &= \frac{e^{-\gamma z}}{Lt_{\mu=\infty} \prod_1^{\infty} \left(1 + \frac{z}{\mu}\right) e^{-\frac{z}{\mu}}}, \end{aligned}$$

where γ is Euler's constant, which shows that for all values of z , real or complex, positive or negative, excepting negative integral values,

$$\Pi(z) = \frac{e^{-\gamma z}}{\text{a finite function of } z},$$

and is therefore finite.

900. Extension of Meaning of $\Gamma(z)$.

So far it has been convenient to adhere to the Legendrian definition of the symbol $\Gamma(x)$, viz.

$$\Gamma(x) = \int_0^{\infty} e^{-v} v^{x-1} dv,$$

and to regard x in this Eulerian integral as representing a real variable. It has been shown to be identical with Gauss' Π function, $\Pi(x-1)$, for all real positive values of x . Having drawn attention to the difference of behaviour of the function defined as an integral and the factor-function of Gauss for negative values of x , it is scarcely worth while observing the distinction further, and we propose to extend the use of the symbol $\Gamma(z)$ to negative and unreal values of z , which means that, when z is negative or unreal, Γ is defined by

$$\Gamma(z+1) = \Pi(z) = Lt_{\mu \rightarrow \infty} \frac{1 \cdot 2 \cdot 3 \dots \mu}{(z+1)(z+2) \dots (z+\mu)} \mu^z,$$

and that when z is positive it is defined either in this way or as $\int_0^{\infty} e^{-v} v^z dv$, and therefore we shall in general regard $\Pi(z)$ as identical with $\Gamma(z+1)$ or $z\Gamma(z)$ for all values of z .

901. Thus a meaning will be given to such an expression as $\Gamma(a+\sqrt{-1}b)$, viz.

$$\begin{aligned} Lt_{\mu \rightarrow \infty} \frac{\mu^{a+ib}}{(a+ib) \left(1 + \frac{a+ib}{1}\right) \left(1 + \frac{a+ib}{2}\right) \dots \left(1 + \frac{a+ib}{\mu}\right)} \\ = \frac{e^{-\gamma(a+ib)}}{\text{a finite function of } (a+ib)} \quad (\text{Art. 89}) \end{aligned}$$

902. Ex. 1. The modulus of $\Gamma(\frac{1}{2}+ia)$ is $\sqrt{\Gamma(\frac{1}{2}+ia)\Gamma(\frac{1}{2}-ia)}$

$$\begin{aligned} &= \sqrt{\{\Gamma(\frac{1}{2}+ia)\Gamma(1-\frac{1}{2}+ia)\}} = \sqrt{\frac{\pi}{\sin(\frac{1}{2}+ia)\pi}} \quad (\text{Art. 895}) \\ &= \sqrt{\frac{\pi}{\cosh a\pi}}. \end{aligned}$$

Ex. 2. If $1, \alpha, \alpha^2, \dots, \alpha^{n-1}$ be the n^{th} roots of 1 (n odd), we have

$$(1+x)(1+\alpha x)(1+\alpha^2 x) \dots (1+\alpha^{n-1} x) = 1+x^n,$$

and

$$1 + \alpha + \alpha^2 + \dots + \alpha^{n-1} = 0.$$

Hence $\Pi(x)\Pi(\alpha x)\Pi(\alpha^2 x) \dots \Pi(\alpha^{n-1} x) = \prod_{r=0}^{r=n-1} \Pi(\alpha^r x)$, say,

$$\begin{aligned} &= Lt_{\mu \rightarrow \infty} \prod_{r=0}^{r=n-1} \frac{\mu^{x\alpha^r}}{\left(1 + \frac{x\alpha^r}{1}\right) \left(1 + \frac{x\alpha^r}{2}\right) \dots \left(1 + \frac{x\alpha^r}{\mu}\right)} \\ &= \frac{1}{\left(1 + \frac{x^n}{1^n}\right) \left(1 + \frac{x^n}{2^n}\right) \left(1 + \frac{x^n}{3^n}\right) \dots \text{to } \infty}, \quad n > 1; \end{aligned}$$

$$\begin{aligned} \therefore \left(1 + \frac{x^n}{1^n}\right) \left(1 + \frac{x^n}{2^n}\right) \left(1 + \frac{x^n}{3^n}\right) \dots \text{to inf.} &= \frac{1}{\prod(x) \prod(\alpha x) \prod(\alpha^2 x) \dots \prod(\alpha^{n-1} x)} \\ &= \frac{1}{\prod_0^{n-1} \{ \prod(\alpha^r x) \}} = \frac{1}{\prod_0^{n-1} P \Gamma(1 + \alpha^r x)} = \frac{1}{x^n \prod_0^{n-1} P \Gamma(\alpha^r x)} \end{aligned}$$

$$\text{thus } x^n \left(1 + \frac{x^n}{1^n}\right) \left(1 + \frac{x^n}{2^n}\right) \left(1 + \frac{x^n}{3^n}\right) \dots = \frac{1}{\Gamma(x) \Gamma(\alpha x) \Gamma(\alpha^2 x) \dots \Gamma(\alpha^{n-1} x)},$$

where 1, α , α^2 , ... are the n^{th} roots of unity.

903. Gauss' Theorem.

This theorem is a generalization of that of Art. 872, and includes it. It states that for any value of z

$$\frac{n^{nz} \prod(z) \prod\left(z - \frac{1}{n}\right) \prod\left(z - \frac{2}{n}\right) \dots \prod\left(z - \frac{n-1}{n}\right)}{\prod(nz)} = (2\pi)^{\frac{n-1}{2}} n^{-\frac{1}{2}},$$

or, what is the same thing, as will be seen,

$$\frac{n^{nz} \Gamma(z) \Gamma\left(z + \frac{1}{n}\right) \Gamma\left(z + \frac{2}{n}\right) \dots \Gamma\left(z + \frac{n-1}{n}\right)}{\Gamma(nz)} = (2\pi)^{\frac{n-1}{2}} n^{\frac{1}{2}}.$$

Let the left-hand member of the first equality be called $\phi(z)$. Then, first, we shall show that $\phi(z)$ is independent of z .

By definition,

$$\begin{aligned} \prod\left(z - \frac{r}{n}\right) &= L_{\mu=\infty} \frac{\mu^{z-\frac{r}{n}} \cdot 1 \cdot 2 \cdot 3 \dots \mu}{\left(1 + z - \frac{r}{n}\right) \left(2 + z - \frac{r}{n}\right) \dots \left(\mu + z - \frac{r}{n}\right)} \\ &= L_{\mu=\infty} \frac{n^\mu \mu^{z-\frac{r}{n}} \cdot 1 \cdot 2 \dots \mu}{(n + nz - r) (2n + nz - r) \dots (\mu n + nz - r)}; \end{aligned}$$

$$\therefore n^{nz} \prod(z) \prod\left(z - \frac{1}{n}\right) \dots \prod\left(z - \frac{n-1}{n}\right) = L \frac{n^{nz} n^{\mu n} \mu^{nz} \mu^{-\frac{n-1}{2}} (\mu!)^n}{D},$$

where D is the product of the factors

$n + nz,$	$2n + nz,$	$3n + nz,$	$\dots \mu n + nz,$
$n + nz - 1,$	$2n + nz - 1,$	$3n + nz - 1,$	$\dots \mu n + nz - 1,$
$n + nz - 2,$	$2n + nz - 2,$	$3n + nz - 2,$	$\dots \mu n + nz - 2,$
\vdots	\vdots	\vdots	\vdots
$n + nz - (n-1),$	$2n + nz - (n-1),$	$3n + nz - (n-1),$	$\dots \mu n + nz - (n-1)$

i.e.

$$\begin{aligned} &[(nz+1)(nz+2) \dots (nz+n)][(nz+n+1) \dots (nz+2n)] \dots [\dots (nz+\mu n)] \\ &= (nz+1)(nz+2) \dots (nz+\mu n). \end{aligned}$$

Hence

$$n^{nz} \Pi(z) \Pi\left(z - \frac{1}{n}\right) \dots \Pi\left(z - \frac{n-1}{n}\right) = Lt \frac{n^{nz} n^{n\mu} \mu^{nz} \mu^{-\frac{n-1}{2}} (\mu!)^n}{(nz+1)(nz+2) \dots (nz+n\mu)}.$$

Again, writing $n\mu$ for μ in Gauss' expression for $\Pi(nz)$,

$$\Pi(nz) = Lt \frac{(n\mu)^{nz} (n\mu!)^n}{(nz+1)(nz+2) \dots (nz+n\mu)}.$$

Hence

$$\begin{aligned} \phi(z) &= Lt \frac{n^{nz} n^{n\mu} \mu^{nz} \mu^{-\frac{n-1}{2}} (\mu!)^n}{(n\mu)^{nz} (n\mu!)^n} \\ &= Lt_{\mu=\infty} n^{n\mu} \mu^{-\frac{n-1}{2}} \frac{(\mu!)^n}{(n\mu!)^n}, \end{aligned}$$

from which the z has disappeared.

Hence, $\phi(z)$ is independent of z . It remains to find its value. To do this we may either obtain the limit of the right-hand side directly, or avoid this by comparison with a known case, for a particular value of z , which will be a legitimate process, inasmuch as its value, not containing z at all, is an absolute numerical constant containing n .

Adopting the direct method and employing Stirling's result,

$$\begin{aligned} \phi(z) &= Lt_{\mu=\infty} n^{n\mu} \mu^{-\frac{n-1}{2}} \frac{(\sqrt{2\mu\pi} \mu^{\mu} e^{-\mu})^n}{\sqrt{2n\mu\pi} (n\mu)^{n\mu} e^{-n\mu}} \\ &= Lt \frac{n^{n\mu} \mu^{-\frac{n-1}{2}} (2\pi)^{\frac{n-1}{2}} \mu^{\frac{n-1}{2}} \mu^{n\mu} e^{-n\mu}}{\mu^{\frac{1}{2}} n^{\frac{1}{2}} (n\mu)^{n\mu} e^{-n\mu}} = \frac{(2\pi)^{\frac{n-1}{2}}}{n^{\frac{1}{2}}}. \end{aligned}$$

Hence, finally,

$$\phi(z) \equiv \frac{n^{nz} \Pi(z) \Pi\left(z - \frac{1}{n}\right) \Pi\left(z - \frac{2}{n}\right) \dots \Pi\left(z - \frac{n-1}{n}\right)}{\Pi(nz)} = \frac{(2\pi)^{\frac{n-1}{2}}}{n^{\frac{1}{2}}}.$$

904. If we adopt the plan of comparison with a known case, take the case of a real value of z , viz. $z=0$.

Then, remembering that $\Pi(x) = \Gamma(1+x)$,

$$\phi(z) = \phi(0) \equiv \Gamma(1) \Gamma\left(1 - \frac{1}{n}\right) \Gamma\left(1 - \frac{2}{n}\right) \dots \Gamma\left(1 - \frac{n-1}{n}\right) / \Gamma(1);$$

or, reversing the order,

$$= \Gamma\left(\frac{1}{n}\right) \Gamma\left(\frac{2}{n}\right) \Gamma\left(\frac{3}{n}\right) \dots \Gamma\left(\frac{n-1}{n}\right) = \frac{(2\pi)^{\frac{n-1}{2}}}{n^{\frac{1}{2}}}, \text{ by Art. 873.}$$

Writing $\Pi(z)=\Gamma(z+1)$, etc, we have

$$\frac{n^{nz}\Gamma(z+1)\Gamma\left(z+\frac{n-1}{n}\right)\Gamma\left(z+\frac{n-2}{n}\right)\dots\Gamma\left(z+\frac{1}{n}\right)}{\Gamma(nz+1)} = \frac{(2\pi)^{\frac{n-1}{2}}}{n^{\frac{1}{2}}},$$

i.e. reversing the order of the factors in the numerator, with the exception of $\Gamma(z+1)$, and writing $\Gamma(z+1)=z\Gamma(z)$ and $\Gamma(nz+1)=nz\Gamma(nz)$,

$$\frac{n^{nz}z\Gamma(z)\Gamma\left(z+\frac{1}{n}\right)\Gamma\left(z+\frac{2}{n}\right)\dots\Gamma\left(z+\frac{n-1}{n}\right)}{nz\Gamma(nz)} = \frac{(2\pi)^{\frac{n-1}{2}}}{n^{\frac{1}{2}}},$$

$$\text{i.e. } \frac{n^{nz}\Gamma(z)\Gamma\left(z+\frac{1}{n}\right)\Gamma\left(z+\frac{2}{n}\right)\dots\Gamma\left(z+\frac{n-1}{n}\right)}{\Gamma(nz)} = (2\pi)^{\frac{n-1}{2}} n^{\frac{1}{2}},$$

which may be written as

$$\Gamma(z)\Gamma\left(z+\frac{1}{n}\right)\Gamma\left(z+\frac{2}{n}\right)\dots\Gamma\left(z+\frac{n-1}{n}\right) = \Gamma(nz)(2\pi)^{\frac{n-1}{2}} n^{\frac{1}{2}}.$$

905. Cases of Gauss' Theorem.

Putting $z = \frac{1}{n}$ we have the result of Art. 873, viz.

$$\Gamma\left(\frac{1}{n}\right)\Gamma\left(\frac{2}{n}\right)\Gamma\left(\frac{3}{n}\right)\dots\Gamma\left(\frac{n-1}{n}\right) = (2\pi)^{\frac{n-1}{2}} n^{-\frac{1}{2}}.$$

Particular cases are

$$n=2, \quad \Gamma(x)\Gamma\left(x+\frac{1}{2}\right) = \Gamma(2x) \cdot (2\pi)^{\frac{1}{2}} 2^{\frac{1}{2}-2x},$$

$$\text{i.e.} \quad \Gamma(x)\Gamma\left(x+\frac{1}{2}\right) = \frac{\pi^{\frac{1}{2}}}{2^{2x-1}} \Gamma(2x),$$

i.e. putting $\frac{p+1}{2}$ for x ,

$$\Gamma\left(\frac{p+1}{2}\right)\Gamma\left(\frac{p+2}{2}\right) = \frac{\pi^{\frac{1}{2}}}{2^p} \Gamma(p+1);$$

$n=3$ gives $\Gamma(x)\Gamma\left(x+\frac{1}{3}\right)\Gamma\left(x+\frac{2}{3}\right) = \frac{2\pi}{3^{3x-1}} \Gamma(3x)$, etc.

906. The case $n=2$ may be deduced directly from

$$\int_0^{\frac{\pi}{2}} \sin^p \theta \cos^q \theta d\theta = \frac{\Gamma\left(\frac{p+1}{2}\right)\Gamma\left(\frac{q+1}{2}\right)}{2\Gamma\left(\frac{p+q}{2}+1\right)}.$$

For putting $q=p$, we have

$$\int_0^{\frac{\pi}{2}} \sin^p \theta \cos^p \theta d\theta = \frac{\left\{ \Gamma\left(\frac{p+1}{2}\right) \right\}^2}{2\Gamma(p+1)};$$

$$\therefore \int_0^{\frac{\pi}{2}} \sin^p 2\theta d\theta = 2^p \frac{\left\{ \Gamma\left(\frac{p+1}{2}\right) \right\}^2}{2\Gamma(p+1)};$$

and writing $2\theta = \phi$,

$$\int_0^{\frac{\pi}{2}} \sin^p 2\theta d\theta = \frac{1}{2} \int_0^{\pi} \sin^p \phi d\phi = \int_0^{\frac{\pi}{2}} \sin^p \phi d\phi$$

$$= \frac{\Gamma\left(\frac{p+1}{2}\right) \Gamma\left(\frac{1}{2}\right)}{2\Gamma\left(\frac{p+2}{2}\right)};$$

$$\therefore 2^p \frac{\left\{ \Gamma\left(\frac{p+1}{2}\right) \right\}^2}{2\Gamma(p+1)} = \frac{\Gamma\left(\frac{p+1}{2}\right) \sqrt{\pi}}{2\Gamma\left(\frac{p+2}{2}\right)},$$

$$\text{i.e. } 2^p \Gamma\left(\frac{p+1}{2}\right) \Gamma\left(\frac{p+2}{2}\right) = \pi^{\frac{1}{2}} \Gamma(p+1).$$

907. An interesting proof of this result is due to M. Serret, (*Calc. Intég.*, p. 174).

Since $B(p, q) = \int_0^1 x^{p-1} (1-x)^{q-1} dx$ we have

$$B(p, p) = \int_0^1 (x-x^2)^{p-1} dx = \int_0^1 \left[\frac{1}{4} - \left(\frac{1}{2} - x\right)^2 \right]^{p-1} dx.$$

And since the integrand assumes equal values, whether we put $x = \frac{1}{2} + h$ or $\frac{1}{2} - h$, its values are symmetric about $x = \frac{1}{2}$.

Hence

$$B(p, p) = 2 \int_0^{\frac{1}{2}} \left[\frac{1}{4} - \left(\frac{1}{2} - x\right)^2 \right]^{p-1} dx. \quad \text{Writing } \frac{1}{2} - x = \frac{\sqrt{z}}{2},$$

$$\begin{aligned} B(p, p) &= 2 \int_1^0 \frac{1}{2^{2p-2}} (1-z)^{p-1} \left(-\frac{1}{4\sqrt{z}} \right) dz \\ &= \frac{1}{2^{2p-1}} \int_0^1 z^{-\frac{1}{2}} (1-z)^{p-1} dz = \frac{1}{2^{2p-1}} B\left(\frac{1}{2}, p\right), \end{aligned}$$

$$\text{i.e. } \frac{\Gamma(p)\Gamma(p)}{\Gamma(2p)} = \frac{1}{2^{2p-1}} \frac{\Gamma\left(\frac{1}{2}\right)\Gamma(p)}{\Gamma\left(p+\frac{1}{2}\right)} \quad \text{or } 2^{2p-1} \Gamma(p)\Gamma\left(p+\frac{1}{2}\right) = \sqrt{\pi} \Gamma(2p)$$

or writing $2p=q+1$,

$$2^q \Gamma\left(\frac{q+1}{2}\right) \Gamma\left(\frac{q+2}{2}\right) = \sqrt{\pi} \Gamma(q+1).$$

908. Another form of the general theorem is (writing $\frac{x}{n}$ for z)
 $\Gamma\left(\frac{x}{n}\right) \Gamma\left(\frac{x+1}{n}\right) \Gamma\left(\frac{x+2}{n}\right) \dots \Gamma\left(\frac{x+n-1}{n}\right) = \Gamma(x) (2\pi)^{\frac{n-1}{2}} n^{\frac{1}{2}-x}$,
i.e. $\Gamma\left(\frac{x}{n}\right) \Gamma\left(\frac{x+1}{n}\right) \dots \Gamma\left(\frac{x+n}{n}\right) = \Gamma(x) \Gamma\left(1 + \frac{x}{n}\right) (2\pi)^{\frac{n-1}{2}} n^{\frac{1}{2}-x}$.

909. To prove $\int_x^{x+1} \log \Gamma(x) dx = x \log x - x + \frac{1}{2} \log 2\pi$.

Taking Gauss' Theorem for a real variable x ,

$$\Gamma(x) \Gamma\left(x + \frac{1}{n}\right) \Gamma\left(x + \frac{2}{n}\right) \dots \Gamma\left(x + \frac{n-1}{n}\right) = \Gamma(nx) (2\pi)^{\frac{n-1}{2}} n^{\frac{1}{2}-nx},$$

we have, upon taking logarithms,

$$\begin{aligned} \frac{1}{n} \log \left\{ \Gamma(nx) (2\pi)^{\frac{n-1}{2}} n^{\frac{1}{2}-nx} \right\} \\ &= \frac{1}{n} \left\{ \log \Gamma(x) + \log \Gamma\left(x + \frac{1}{n}\right) + \dots + \log \Gamma\left(x + \frac{n-1}{n}\right) \right\} \\ &= \sum \frac{1}{n} \log \Gamma\left(x + \frac{r}{n}\right), \text{ from } r=0 \text{ to } r=n-1, \\ &= \int_0^1 \log \Gamma(x+y) dy, \text{ when } n \text{ is indefinitely increased,} \\ &= \int_x^{x+1} \log \Gamma(v) dv, \text{ if } v \text{ be put for } x+y. \end{aligned}$$

Thus, by Art. 884,

$$\begin{aligned} \int_x^{x+1} \log \Gamma(v) dv &= \lim_{n \rightarrow \infty} \frac{1}{n} \log \left[\frac{\sqrt{2n\pi} (nx)^{nx} e^{-nx}}{nx} (2\pi)^{\frac{n-1}{2}} n^{\frac{1}{2}-nx} \right] \\ &= \frac{1}{2} \log 2\pi + x \log x - x = \log x^x e^{-x} (2\pi)^{\frac{1}{2}}. \end{aligned}$$

910. This expresses the area bounded by the x -axis, the curve $y = \log \Gamma(x)$, and two ordinates at unit distance.

Changing x to $x+1$, and adding to the former,

$$\int_x^{x+2} \log \Gamma(x) dx = \log \{ x^x (x+1)^{x+1} e^{-x} e^{-(x+1)} (2\pi)^{\frac{1}{2}} \},$$

and so on, and more generally,

$$\int_x^{x+n} \log \Gamma(x) dx \\ = \log \left\{ x^x (x+1)^{x+1} (x+2)^{x+2} \dots (x+n-1)^{x+n-1} e^{-nx - \frac{(n-1)n}{2}} (2\pi)^{\frac{n}{2}} \right\},$$

where n is a positive integer.

911. **Expressions for the Differential Coefficients of the Function $\psi(x)$, $\log \Gamma(x+1)$, and Expansion of $\log \Gamma(x+1)$.**

Let us write $\psi(x)$ for $\frac{d}{dx} \log \Gamma(x)$, i. e. $\frac{\Gamma'(x)}{\Gamma(x)}$.

Then taking the logarithmic differential of Gauss' Theorem,

$$\Gamma(nx) = n^{nx} \Gamma(x) \Gamma\left(x + \frac{1}{n}\right) \dots \Gamma\left(x + \frac{n-1}{n}\right) \left| (2\pi)^{\frac{n-1}{2}} n^{\frac{1}{2}} \right|,$$

$$n\psi(nx) = n \log n + \psi(x) + \psi\left(x + \frac{1}{n}\right) + \dots + \psi\left(x + \frac{n-1}{n}\right),$$

and differentiating again,

$$n^2 \psi'(nx) = \psi'(x) + \psi'\left(x + \frac{1}{n}\right) + \dots + \psi'\left(x + \frac{n-1}{n}\right).$$

Hence

$$n\psi'(nx) = \sum \frac{1}{n} \psi'\left(x + \frac{r}{n}\right), \text{ from } r=0 \text{ to } r=n-1,$$

$$\begin{aligned} \text{i.e. } Lt_{n=\infty} n\psi'(nx) &= \int_0^1 \psi'(x+y) dy = \left[\psi(x+y) \right]_{y=0}^{y=1} \\ &= \psi(x+1) - \psi(x) = \frac{d}{dx} \log \Gamma(x+1) - \frac{d}{dx} \log \Gamma(x) \\ &= \frac{d}{dx} \log \frac{\Gamma(x+1)}{\Gamma(x)} = \frac{d}{dx} \log x = \frac{1}{x}, \end{aligned}$$

i.e. $Lt_{n=\infty} (nx)\psi'(nx) = 1$; or writing v for nx , $\psi'(v) = \frac{1}{v}$ in the limit when v is infinite, and therefore $\psi'(v)$ ultimately vanishes.

That is $\frac{d^2}{dx^2} \log \Gamma(x)$ vanishes when x is indefinitely increased.

$$\text{Now} \quad \Gamma(x) = \frac{\Gamma(x+n+1)}{x(x+1)(x+2)\dots(x+n)}.$$

Hence, taking the logarithmic differential,

$$\psi(x) = -\frac{1}{x} - \frac{1}{x+1} - \frac{1}{x+2} - \dots - \frac{1}{x+n} + \psi(x+n+1),$$

and differentiating again,

$$\psi'(x) = \frac{1}{x^2} + \frac{1}{(x+1)^2} + \frac{1}{(x+2)^2} + \dots + \frac{1}{(x+n)^2} + \psi'(x+n+1),$$

and it has just been proved that $\psi'(x+n+1)$ ultimately vanishes when n has been indefinitely increased.

$$\therefore \frac{d^2}{dx^2} \log \Gamma(x) \equiv \psi'(x) = \frac{1}{x^2} + \frac{1}{(x+1)^2} + \frac{1}{(x+2)^2} + \dots \text{ to } \infty \dots (1)$$

The series (1) is obviously convergent for all values of $x > 0$ becoming infinite at $x=0$.

Integrating this equation between limits 1 and x , we have

$$\begin{aligned} \psi(x) - \psi(1) &= \left[-\frac{1}{x}\right]_1^x + \left[-\frac{1}{x+1}\right]_1^x + \left[-\frac{1}{x+2}\right]_1^x + \dots \\ &= \left(\frac{1}{1} - \frac{1}{x}\right) + \left(\frac{1}{2} - \frac{1}{x+1}\right) + \left(\frac{1}{3} - \frac{1}{x+2}\right) + \dots \dots \dots (2) \end{aligned}$$

which is a convergent series; for the test expression, viz.

$$Lt_{n=\infty} n \left(1 - \frac{u_{n+1}}{u_n}\right) = Lt \frac{n(x+2n)}{(n+1)(x+n)} = 2,$$

and is greater than unity. (See Smith's *Algebra*, Art. 342.)

Again, we have seen that

$$n\psi(nx) = n \log n + \psi(x) + \psi\left(x + \frac{1}{n}\right) + \dots + \psi\left(x + \frac{n-1}{n}\right),$$

and putting $x=1$,

$$\psi(n) = \log n + \sum \frac{1}{n} \psi\left(1 + \frac{r}{n}\right), \text{ from } r=0 \text{ to } r=n-1.$$

Hence when n increases indefinitely,

$$\begin{aligned} Lt_{n=\infty} [\psi(n) - \log n] &= \int_0^1 \psi(1+x) dx \\ &= \left[\log \Gamma(1+x)\right]_0^1 = \log \frac{\Gamma(2)}{\Gamma(1)} = \log 1 = 0. \end{aligned}$$

That is,
$$Lt_{n=\infty} \left(\frac{\Gamma'(n)}{\Gamma(n)} - \log n\right) = 0. \dots \dots \dots (3)$$

Putting $x = \infty$ in equation (2),

$$\psi(\infty) - \psi(1) = \frac{1}{1} + \frac{1}{2} + \frac{1}{3} + \dots \text{ to } \infty,$$

i.e. by equation (3),

$$-\psi(1) = Lt_{n=\infty} \left(\frac{1}{1} + \frac{1}{2} + \dots + \frac{1}{n} - \log n \right) \\ = \text{Euler's Constant } \gamma,$$

i.e. $\psi(1)$, or $\left\{ \frac{d}{dx} \log \Gamma(x+1) \right\}_{x=0} = -\gamma$(4)

Hence, by equation (2),

$$\frac{d}{dx} \log \Gamma(x) \equiv \psi(x) = -\gamma + \left(\frac{1}{1} - \frac{1}{x} \right) + \left(\frac{1}{2} - \frac{1}{x+1} \right) + \dots \text{ to } \infty \\ = -\gamma + \frac{1}{1} \frac{x-1}{x} + \frac{1}{2} \frac{x-1}{x+1} + \dots + \frac{1}{n} \frac{x-1}{x+n-1} + \dots \text{ to } \infty, \dots\dots(5)$$

which may also be written as

$$\frac{d}{dx} \log \Gamma(x+1) = Lt_{n=\infty} \left[\log n - \frac{1}{x+1} - \frac{1}{x+2} - \dots - \frac{1}{x+n} \right].$$

Again, differentiating equation (1) $n-2$ times, we have

$$\frac{d^n}{dx^n} \log \Gamma(x) = (-1)^n (n-1)! \left[\frac{1}{x^n} + \frac{1}{(x+1)^n} + \frac{1}{(x+2)^n} + \dots \text{ to } \infty \right], \quad (6)$$

i.e. $\psi^{(n-1)}(1)$, or $\left\{ \frac{d^n}{dx^n} \log \Gamma(x) \right\}_{x=1} = (-1)^n (n-1)! S_n$,

where $S_n = \frac{1}{1^n} + \frac{1}{2^n} + \frac{1}{3^n} + \dots$,

which is convergent if $n > 1$; or, what is the same thing,

$$\left\{ \frac{d^n}{dx^n} \log \Gamma(x+1) \right\}_{x=0} = (-1)^n (n-1)! S_n. \dots\dots\dots(7)$$

Also $\left\{ \log \Gamma(x+1) \right\}_{x=0} = \log \Gamma(1) = 0$;

we thus have

$$\left\{ \log \Gamma(x+1) \right\}_{x=0} = 0; \quad \left\{ \frac{d}{dx} \log \Gamma(x+1) \right\}_{x=0} = -\gamma;$$

and $\left\{ \frac{d^n}{dx^n} \log \Gamma(x+1) \right\}_{x=0} = (-1)^n (n-1)! S_n$, where n is ≤ 2 .

Maclaurin's Theorem then gives

$$\log \Gamma(x+1) = -\gamma x + S_2 \frac{x^2}{2} - S_3 \frac{x^3}{3} + S_4 \frac{x^4}{4} - \dots + (-1)^n S_n \frac{x^n}{n} + \dots,$$

a result otherwise established in a subsequent article, and which will be thrown into a more convergent form, by the addition of other known series, for working purposes. This series is convergent if x be numerically < 1 .

912. Collecting for convenience other useful results of the above article, we have

(a) $Lt_{x=\infty} \frac{d^2}{dx^2} \log \Gamma(x) = 0$ and $Lt_{x=0} \frac{d^2}{dx^2} \log \Gamma(x) = \infty$, and in

any case $\frac{d^2}{dx^2} \log \Gamma(x) = \frac{1}{x^2} + \frac{1}{(x+1)^2} + \frac{1}{(x+2)^2} + \dots$ to ∞ , and is positive.

(b) $\frac{\Gamma'(n)}{\Gamma(n)} = \log n$ when n is infinitely large.

(c) $\left\{ \frac{d}{dx} \log \Gamma(x+1) \right\}_{x=0} = -\gamma$, and $\therefore \left\{ \frac{d}{dx} \log \Gamma(x) \right\}_{x=1} = -\gamma$.

(d) $\frac{d}{dx} \log \Gamma(x+1) = -\gamma + \left(\frac{1}{1} - \frac{1}{x+1} \right) + \left(\frac{1}{2} - \frac{1}{x+2} \right) + \dots$ to ∞ .

(e) Since $\frac{d^2}{dx^2} \log \Gamma(x)$ is continuously positive for all positive values of x , $\frac{d}{dx} \log \Gamma(x)$ is an increasing function as x increases from 0 to ∞ , starting from the value $-\infty$ at $x=0$; or, putting this geometrically, the tangent to the graph of $y = \log \Gamma(x)$ is continuously rotating in a counter-clockwise direction as x passes from zero to infinity; and the curve is always convex to the foot of the ordinate.

913. The student may note the following particular values of $\frac{d^2}{dx^2} \log \Gamma(x)$, i.e. $\psi'(x)$, viz. taking $\pi^2 = 9.8696044011$,

$$\psi'(0) = \frac{1}{\left(\frac{1}{2}\right)^2} + \frac{1}{\left(\frac{3}{2}\right)^2} + \frac{1}{\left(\frac{5}{2}\right)^2} + \dots = 4 \left(\frac{1}{1^2} + \frac{1}{3^2} + \frac{1}{5^2} + \dots \right) = 4 \cdot \frac{\pi^2}{8} = \frac{\pi^2}{2} = \infty,$$

$$\psi'(0.5) = \frac{1}{\left(\frac{1}{2}\right)^2} + \frac{1}{\left(\frac{3}{2}\right)^2} + \frac{1}{\left(\frac{5}{2}\right)^2} + \dots = 4 \left(\frac{1}{1^2} + \frac{1}{3^2} + \frac{1}{5^2} + \dots \right) = 4 \cdot \frac{\pi^2}{8} = \frac{\pi^2}{2} = 4.9348022,$$

$$\psi'(1) = \frac{1}{1^2} + \frac{1}{2^2} + \frac{1}{3^2} + \dots = \frac{\pi^2}{6} = 1.6449341,$$

$$\psi'(1.5) = 4 \left(\frac{1}{3^2} + \frac{1}{5^2} + \dots \right) = 4 \left(\frac{\pi^2}{8} - \frac{1}{1^2} \right) = \frac{\pi^2}{2} - 4 = .9348022,$$

$$\psi'(2) = \frac{1}{2^2} + \frac{1}{3^2} + \frac{1}{4^2} + \dots = \frac{\pi^2}{6} - 1 = .6449341,$$

$$\psi'(2.5) = 4 \left(\frac{1}{5^2} + \frac{1}{7^2} + \dots \right) = 4 \left(\frac{\pi^2}{8} - \frac{1}{1^2} - \frac{1}{3^2} \right) = \frac{\pi^2}{2} - 4.4 = .4903578,$$

$$\psi'(3) = \frac{1}{3^2} + \frac{1}{4^2} + \frac{1}{5^2} + \dots = \frac{\pi^2}{6} - \frac{1}{1^2} - \frac{1}{2^2} = \frac{\pi^2}{6} - 1.25 = .3949341,$$

etc.

$$\psi'(\infty) = 0,$$

which indicate how $\frac{d^2}{dx^2} \log \Gamma(x)$ is decreasing as x increases, but always remaining positive.

914. Since $\log \Gamma(x+1) = -\gamma x + S_2 \frac{x^2}{2} - S_3 \frac{x^3}{3} + S_4 \frac{x^4}{4} - \dots$, we may write $\Gamma(x+1)$ as

$$\begin{aligned} \Gamma(x+1) &= e^{-\gamma x} e^{S_2 \frac{x^2}{2}} e^{-S_3 \frac{x^3}{3}} e^{S_4 \frac{x^4}{4}} \dots \\ &= \left(1 - \gamma x + \frac{\gamma^2 x^2}{2!} - \frac{\gamma^3 x^3}{3!} + \dots\right) \left(1 + S_2 \frac{x^2}{2} \dots\right) \left(1 - S_3 \frac{x^3}{3} \dots\right) \dots \\ &= 1 - \gamma x + (\gamma^2 + S_2) \frac{x^2}{2!} - (\gamma^3 + 3\gamma S_2 + 2S_3) \frac{x^3}{3!} + \dots, \end{aligned}$$

which expands $\Gamma(x+1)$ as far as cubes of x , and which might be useful for very small values of x , but the presence of powers of γ renders calculation troublesome, and less inconvenient methods of calculation will be given later.

915. It is noticeable, too, that

$$\frac{\log \Gamma(x+1)}{x} = -\gamma + S_2 \frac{x}{2} - S_3 \frac{x^2}{3} + S_4 \frac{x^3}{4} - \dots,$$

and that the several differential coefficients of this expression are therefore free from Euler's Constant γ , viz.

$$\begin{aligned} \frac{d^n \log \Gamma(x+1)}{dx^n} &= (-1)^{n-1} \left\{ \frac{S_{n+1}}{n+1} n! - \frac{S_{n+2}}{n+2} \frac{(n+1)!}{1!} x + \frac{S_{n+3}}{n+3} \frac{(n+2)!}{2!} x^2 - \dots \right\} \\ &= (-1)^{n-1} n! \left\{ \frac{S_{n+1}}{n+1} - \frac{n+1}{1} \frac{S_{n+2}}{n+2} x + \frac{n+1}{1} \frac{n+2}{2} \frac{S_{n+3}}{n+3} x^2 - \dots \right\}. \end{aligned}$$

And, similarly, if m be any positive integer,

$$\begin{aligned} \frac{d^n}{dx^n} x^m \log \Gamma(x+1) &= \left(\frac{d}{dx}\right)^n \left[-\gamma x^{m+1} + \sum_r^{\infty} (-1)^r \frac{S_r}{r} x^{m+r} \right] \\ &= -(m+1)_n \gamma x^{m+1-n} + \sum_r^{\infty} (-1)^r \frac{S_r}{r} (m+r)_n x^{m+r-n}, \end{aligned}$$

where $(m+1)_r$ denotes $(m+1)(m)(m-1) \dots$ to r factors, if $n \leq m+1$, and is free from γ if $n > m+1$; also that

$$\left[\frac{d^{m+1}}{dx^{m+1}} (x^m \log \Gamma(x+1)) \right]_{r=0} = -(m+1)! \gamma.$$

1916. **Expansion of $\log \Gamma(1+x)$ deduced from the Π Function.**

The series

$$\log \Gamma(1+x) = -\gamma x + S_2 \frac{x^2}{2} - S_3 \frac{x^3}{3} + S_4 \frac{x^4}{4} - \dots$$

may be arrived at at once by taking the logarithm of the Gauss formula in the form

$$\Gamma(1+x) = L_{\mu=\infty} \frac{\mu^x}{\left(1+\frac{x}{1}\right)\left(1+\frac{x}{2}\right)\dots\left(1+\frac{x}{\mu}\right)},$$

viz.

$$\log \Gamma(1+x) = x \log \mu - \log\left(1+\frac{x}{1}\right) - \log\left(1+\frac{x}{2}\right) - \log\left(1+\frac{x}{3}\right) - \dots;$$

and expanding the logarithms, supposing $-1 < x < 1$,

$$\log \Gamma(1+x) = L \left[x (\log \mu - S_1) + S_2 \frac{x^2}{2} - S_3 \frac{x^3}{3} + \dots \right],$$

where
$$S_r = \frac{1}{1^r} + \frac{1}{2^r} + \frac{1}{3^r} + \dots,$$

and $L(S_1 - \log \mu) =$ Euler's Constant γ , and the series S_r ($r > 1$) are all convergent.

Hence,

$$\log \Gamma(1+x) = -\gamma x + S_2 \frac{x^2}{2} - S_3 \frac{x^3}{3} + S_4 \frac{x^4}{4} - \dots + (-1)^n S_n \frac{x^n}{n} + \dots; \quad (-1 < x < 1). \quad (1)$$

Now, the even terms may be removed by the addition of $\frac{1}{2} \log \frac{x\pi}{\sin x\pi}$.

For
$$\frac{\sin x\pi}{x\pi} = \left(1-\frac{x^2}{1^2}\right)\left(1-\frac{x^2}{2^2}\right)\left(1-\frac{x^2}{3^2}\right)\dots \textit{ad inf.};$$

and taking logarithms and expanding,

$$0 = \frac{1}{2} \log \frac{x\pi}{\sin x\pi} - S_2 \frac{x^2}{2} - S_4 \frac{x^4}{4} - \dots \dots \dots (2)$$

Adding to equation (1),

$$\log \Gamma(1+x) = \frac{1}{2} \log \frac{x\pi}{\sin x\pi} - \gamma x - S_3 \frac{x^3}{3} - S_5 \frac{x^5}{5} - \dots \dots (3)$$

The coefficients S_3, S_5, \dots all begin with a unit. This may be removed and the series reduced to a much more convergent form by the addition of the series for $\tanh^{-1}x$ to each side,

viz.

$$\tanh^{-1}x = \frac{1}{2} \log \frac{1+x}{1-x} = x + \frac{x^3}{3} + \frac{x^5}{5} + \dots$$

And we then obtain

$$\log \Gamma(1+x) = \frac{1}{2} \log \frac{x\pi}{\sin x\pi} - \tanh^{-1} x + (1-\gamma)x - (S_3-1)\frac{x^3}{3} - (S_5-1)\frac{x^5}{5} - \dots \dots \dots (4)$$

The values of $\gamma, S_2, S_3, \dots S_{35}$ are all calculated, and the tabulated results are given in Art. 957. Euler calculated S_2 to S_{15} . Legendre* gave the values S_2 to S_{35} to sixteen decimal places. The list in Art. 957 is taken from Legendre's list as given by De Morgan, *Diff. Calc.*, p. 554. The series (4) converges rapidly and is used for the calculation of the values of $\log \Gamma(x)$. Legendre gives a table of values of $L\Gamma(x)$, i.e. $10 + \log \Gamma(x)$, from $L\Gamma(1\cdot000)$ to $L\Gamma(2\cdot000)$ to seven decimal places, in his *Exercices du Calcul Intégral*, pages 301 to 306. A table is also given by Bertrand, *Calc. Int.*, p. 285.

917. Calculation of Euler's Constant γ .

These series may be used for the calculation of Euler's Constant γ by taking a value of x , for which $\Gamma(x)$ is otherwise known, viz. $x = \frac{1}{2}$, for which $\Gamma(x) = \sqrt{\pi}$.

Equation (1) gives

$$\gamma = -\frac{1}{x} \log \Gamma(x+1) + S_2 \frac{x}{2} - S_3 \frac{x^2}{3} + S_4 \frac{x^3}{4} - \dots;$$

and putting $x = \frac{1}{2}$,

$$\gamma = \log_e \frac{4}{\pi} + \frac{1}{2} S_2 \cdot \frac{1}{2} - \frac{1}{3} S_3 \frac{1}{2^2} + \frac{1}{4} S_4 \frac{1}{2^3} - \dots \dots \dots (5)$$

Equation (3) gives, by changing the sign of x ,

$$\log \Gamma(1-x) = \frac{1}{2} \log \frac{x\pi}{\sin x\pi} + \gamma x + S_3 \frac{x^3}{3} + S_5 \frac{x^5}{5} + \dots;$$

and putting $x = \frac{1}{2}$ in this,

$$\gamma = \log 2 - \frac{1}{3} S_3 \frac{1}{2^2} - \frac{1}{5} S_5 \frac{1}{2^4} - \frac{1}{7} S_7 \frac{1}{2^6} - \dots, \dots \dots (6)$$

which is more rapidly convergent than the former.

Formula (4) gives

$$\log \frac{\sqrt{\pi}}{2} = \frac{1}{2} \log \frac{\pi}{2} - \frac{1}{2} \log 3 + \frac{1-\gamma}{2} - \frac{S_3-1}{3} \frac{1}{2^3} - \frac{S_5-1}{5} \frac{1}{2^5} - \dots$$

i.e.
$$\gamma = \log_e \frac{2e}{3} - \frac{S_3-1}{3} \frac{1}{2^2} - \frac{S_5-1}{5} \frac{1}{2^4} - \frac{S_7-1}{7} \frac{1}{2^6} - \dots \dots (7)$$

* *Traité des fonctions elliptiques*, Legendre.

This is the best of the three series to employ to find γ .

And with the aid of the tables of values of S_p the calculation to seven places, which is all that is likely to be wanted for ordinary purposes, may be readily performed.

The value of γ is

$$\gamma = \cdot 57721\ 56649\ 01532\ 8606\dots,$$

and $1 - \gamma = \cdot 42278\ 43350\ 98467\ 1394\dots$

The value of $\log_e 10$ is of course required. It is

$$\log_e 10 = 2\cdot 30258\ 50929\ 94045\ 68401\ 79914\dots,$$

and the modulus $\log_{10} e = \cdot 43429\ 44819\dots$

918. The numerical calculation of values of $\log \Gamma(1+x)$, and therefore of $\Gamma(x)$ itself, will now present no difficulty. With the values of $\frac{S_3-1}{3}$, $\frac{S_5-1}{5}$, etc., inserted, the working formula stands* as

$$\begin{aligned} \log_e \Gamma(1+x) = & \frac{1}{2} \log_e \frac{x\pi}{\sin x\pi} - \frac{1}{2} \log_e \frac{1+x}{1-x} + \cdot 4227843x \\ & - \cdot 06735230x^3 \\ & - \cdot 0073855x^5 \\ & - \cdot 0011927x^7 \\ & - \cdot 0002231x^9 \\ & - \text{etc.}, \end{aligned}$$

and is rapidly convergent for the small values of x less than $x = \frac{1}{2}$, 2^{10} being 1024. Hence the last term $\cdot 0002231x^9$ in the case $x = \frac{1}{2}$ becomes $\cdot 0000004$, whilst for $x = \frac{1}{3}$, which is the largest value of x for which it will be necessary to use the series (see Art. 921), the error in omitting all the remaining terms of the series will not affect the seventh decimal place. Hence we have here all that is necessary for the construction of seven-figure tables for $\log \Gamma(x)$.

919. It is worth noting that the addition of $\log(1+x)$ and $\log(1-x)$ respectively to $\Gamma(1+x)$ and $\Gamma(1-x)$, viz.

$$\log \Gamma(1+x) = -\gamma x + S_2 \frac{x^2}{2} - S_3 \frac{x^3}{3} + S_4 \frac{x^4}{4} - \dots$$

and $\log \Gamma(1-x) = \gamma x + S_2 \frac{x^2}{2} + S_3 \frac{x^3}{3} + S_4 \frac{x^4}{4} + \dots$

* Bertrand, *Calc. Intégral*, p. 250.

give $\log \Gamma(1+x) = -\log(1+x) + (1-\gamma)x$
 $+ (S_2-1)\frac{x^2}{2} - (S_3-1)\frac{x^3}{3} + (S_4-1)\frac{x^4}{4} - \dots$

and $\log \Gamma(1-x) = -\log(1-x) - (1-\gamma)x$
 $+ (S_2-1)\frac{x^2}{2} + (S_3-1)\frac{x^3}{3} + (S_4-1)\frac{x^4}{4} + \dots$;

whence

$$\frac{1}{2} \log \frac{\Gamma(1+x)}{\Gamma(1-x)} = -\tanh^{-1}x + (1-\gamma)x - (S_3-1)\frac{x^3}{3} - (S_5-1)\frac{x^5}{5} - \dots$$

But $\frac{1}{2} \log \Gamma(1+x) \Gamma(1-x) = \frac{1}{2} \log \frac{\pi x}{\sin \pi x}$, *i.e.* adding,

$$\log \Gamma(1+x) = \frac{1}{2} \log \frac{\pi x}{\sin \pi x} - \tanh^{-1}x + (1-\gamma)x - \sum_1^{\infty} (S_{2n+1}-1) \frac{x^{2n+1}}{2n+1},$$

the same series as before, which may be written

$$\log \Gamma(1+x) = \frac{1}{2} \log \left(\frac{\pi x}{\sin \pi x} \frac{1-x}{1+x} \right) + (1-\gamma)x - \sum_1^{\infty} (S_{2n+1}-1) \frac{x^{2n+1}}{2n+1};$$

and putting $x=1$, since $L_{x=1} \frac{1-x}{\sin \pi x} = \frac{-1}{\pi \cos \pi} = \frac{1}{\pi}$,

$$1-\gamma = \frac{1}{2} \log 2 + \sum_1^{\infty} \frac{S_{2n+1}-1}{2n+1};$$

and putting $x=\frac{1}{2}$, since $\Gamma(\frac{3}{2}) = \frac{1}{2}\sqrt{\pi}$,

$$1-\gamma = \log 1.5 + \sum_1^{\infty} \frac{S_{2n+1}-1}{(2n+1)2^{2n}} \quad (\text{cf. Art. 917}).$$

These series are given both by Serret and Bertrand for the calculation of $\Gamma(1+x)$ and γ .

The formulae

$$\log \Gamma(1+x) = \frac{1}{2} \log \frac{\pi x}{\sin \pi x} - \gamma x - \frac{1}{3} S_3 x^3 - \frac{1}{5} S_5 x^5 - \dots,$$

$$\log \Gamma(1-x) = \frac{1}{2} \log \frac{\pi x}{\sin \pi x} + \gamma x + \frac{1}{3} S_3 x^3 + \frac{1}{5} S_5 x^5 + \dots$$

and $\gamma = \log 2 - \frac{1}{3} \frac{S_3}{2^2} - \frac{1}{5} \frac{S_5}{2^4} - \frac{1}{7} \frac{S_7}{2^6} - \dots,$

were given by Legendre (*Exercices*, p. 299). But the addition of the series for $\tanh^{-1}x$ adds to the rapidity of the convergence.

920. Since $\Gamma(m)\Gamma(1-m) = \frac{\pi}{\sin m\pi}$, we have, on putting $\frac{1+x}{2}$ for m ,

$$\Gamma\left(\frac{1+x}{2}\right)\Gamma\left(\frac{1-x}{2}\right) = \frac{\pi}{\sin \frac{1+x}{2}\pi} = \frac{\pi}{\cos \frac{x\pi}{2}}. \dots\dots(i)$$

But
$$\Gamma(x) = 2^{1-2x}\sqrt{\pi} \frac{\Gamma(2x)}{\Gamma\left(\frac{1}{2}+x\right)} \quad (\text{Art } 905).$$

Hence, writing $\frac{x}{2}$ in place of x ,

$$\Gamma\left(\frac{x}{2}\right) = 2^{1-x}\sqrt{\pi} \frac{\Gamma(x)}{\Gamma\left(\frac{1}{2}+\frac{x}{2}\right)}. \dots\dots(ii)$$

From equations (i) and (ii), eliminating $\Gamma\left(\frac{1+x}{2}\right)$, we have

$$\Gamma(x) = \frac{\sqrt{\pi}}{2^{1-x}\cos \frac{x\pi}{2}} \frac{\Gamma\left(\frac{x}{2}\right)}{\Gamma\left(\frac{1-x}{2}\right)}. \dots\dots(iii)$$

921. By means of the four formulae

$$\Gamma(x) = (x-1)\Gamma(x-1), \dots(1); \quad \Gamma(x)\Gamma(1-x) = \frac{\pi}{\sin x\pi}, \dots\dots(2);$$

$$\Gamma(x) = 2^{1-2x}\sqrt{\pi} \frac{\Gamma(2x)}{\Gamma\left(\frac{1}{2}+x\right)}, \dots(3); \quad \Gamma(x) = \frac{\sqrt{\pi}}{2^{1-x}\cos \frac{x\pi}{2}} \frac{\Gamma\left(\frac{x}{2}\right)}{\Gamma\left(\frac{1-x}{2}\right)}, (4);$$

it may be shown that $\Gamma(x)$ can be calculated for all values of x when those between $\Gamma\left(\frac{1}{2}\right)$ and $\Gamma\left(\frac{1}{3}\right)$ have been calculated.

(a) For $1 < x < \infty$, reduce by continued application of formula (1) to a case $0 < y < 1$.

(b) For $\frac{2}{3} < x < 1$, reduce by formula (2) to a case $0 < y < \frac{1}{3}$.

(c) For $\frac{1}{3} < x < \frac{2}{3}$, reduce by formula (4) to a case $\frac{1}{6} < y < \frac{1}{3}$.

$$\text{For if } x > \frac{1}{3}, \quad \frac{x}{2} > \frac{1}{6} \quad \text{and} \quad \frac{1-x}{2} < \frac{1}{3};$$

$$\text{and if } x < \frac{2}{3}, \quad \frac{x}{2} < \frac{1}{3} \quad \text{and} \quad \frac{1-x}{2} > \frac{1}{6}.$$

(d) If $\frac{1}{6} < x < \frac{1}{3}$, the case needs no reduction.

(e) If $0 < x < \frac{1}{6}$, use formula (3). This involves $\Gamma(\frac{1}{2} + x)$, and $\frac{1}{2} + x$ lies between $\frac{1}{2}$ and $\frac{2}{3}$, and therefore falls under case (c), and an application of formula (4) reduces $\Gamma(x + \frac{1}{2})$ to cases in which the arguments lie as before, viz. $\frac{1}{3} < y < \frac{1}{3}$.

In $\Gamma(2x)$, which occurs in the numerator of formula (3), if $0 < x < \frac{1}{6}$, we have $0 < 2x < \frac{1}{3}$, and if $2x > \frac{1}{6}$, no further reduction is necessary.

But if $0 < x < \frac{1}{12}$, we have

$$0 < 2x < \frac{1}{6} \quad \text{and} \quad 0 < 4x < \frac{1}{3}.$$

We then use formula (3) with $2x$ written for x ,

i.e.
$$\Gamma(2x) = \sqrt{\pi} 2^{1-4x} \frac{\Gamma(4x)}{\Gamma(\frac{1}{2} + 2x)}.$$

Similarly if $0 < x < \frac{1}{24}$, use

$$\Gamma(4x) = \sqrt{\pi} 2^{1-8x} \frac{\Gamma(8x)}{\Gamma(\frac{1}{2} + 4x)},$$

and so on.

Hence it follows that the use of series will be only necessary in the case of $\Gamma(x)$, where x lies from $\frac{1}{3}$ to $\frac{1}{3}$, and that when this group is calculated by the series, all others follow by the above rules.

922. Graph of $y = \Gamma(x) = \int_0^\infty e^{-z} z^{x-1} dz.$

Regarded as defined by the integral, it is plain that so long as x is real and positive $\Gamma(x)$ is a positive function, and that it becomes infinite if $x=0$, as may also be seen from the fact that $\Gamma(x) = \frac{1}{x} \Gamma(x+1)$, and therefore $\Gamma(0) = \frac{\Gamma(1)}{0} = \infty$.

We have seen that

$$\frac{d^2}{dx^2} \log \Gamma(x) = \frac{1}{x^2} + \frac{1}{(x+1)^2} + \frac{1}{(x+2)^2} + \dots,$$

and therefore is infinite when $x=0$, but for all values of x from 0 to ∞ it remains positive and finite. Hence

$$\frac{d}{dx} \log \Gamma(x), \quad \text{i.e.} \quad \frac{\Gamma'(x)}{\Gamma(x)},$$

is an increasing function of x , and its value at $x=0$ is obviously $-\infty$, for

$$\frac{d}{dx} \log \Gamma(x) = -\gamma + \left(\frac{1}{1} - \frac{1}{x}\right) + \left(\frac{1}{2} - \frac{1}{x+1}\right) + \dots \quad (\text{Art. 911}).$$

Also, when x is $+\infty$,

$$\frac{d \log \Gamma(x)}{dx} = -\gamma + \frac{1}{1} + \frac{1}{2} + \dots \text{ to } \infty = +\infty.$$

Hence $\frac{\Gamma'(x)}{\Gamma(x)}$ increases from $-\infty$ through zero to $+\infty$ as x increases from 0 to ∞ and as $\Gamma(x)$ remains positive throughout, $\Gamma'(x)$ changes from negative to positive once, and once only, as x increases from 0 to ∞ .

Therefore $\Gamma(x)$ has one, and only one, stationary value, and that is a minimum, and $\Gamma(x)$ decreases from ∞ when $x=0$ to $\Gamma(1)=1$ when $x=1$, and since $\Gamma(2)=1$ and $\Gamma(1)=1$, the ordinates at $x=1$ and $x=2$ are equal, and the minimum lies somewhere between $x=1$ and $x=2$, and is numerically less than unity. From $x=2$ to $x=\infty$ the value of $\Gamma(x)$ is continually increasing.

The curve then

- (a) lies entirely on the upper side of the x -axis;
- (b) it is asymptotic to the y -axis;
- (c) it has a minimum between $x=1$ and $x=2$;
- (d) it recedes from the x -axis from $x=2$ to $x=\infty$.

The equation to find the exact position of the minimum ordinate is $\frac{d \Gamma(x)}{dx} = 0$, or writing $x=1+t$, $\frac{d}{dt} \Gamma(1+t) = 0$.

$$\text{Also} \quad \frac{d \log \Gamma(1+t)}{dt} = \frac{\Gamma'(1+t)}{\Gamma(1+t)}.$$

$$\text{Hence} \quad \frac{d}{dt} \Gamma(1+t) = \Gamma(1+t) \left[-\frac{1}{1+t} + (1-\gamma) + (S_2-1)t - (S_3-1)t^2 + \dots \right],$$

and t is to be found by trial from

$$\frac{1}{1+t} = 0.422784 \dots + (S_2-1)t - (S_3-1)t^2 + \dots;$$

and substituting for S_2 and S_3 their values in decimals to a few places, an approximate value for t may be obtained, and by the usual approximation methods the result may be found as nearly as desired. Serret gives the result to seven places, viz.

$$t = 0.4616321 \dots$$

i.e. the abscissa of the minimum ordinate is

$$x = 1 + t = 1.4616321\dots,$$

and the value of the corresponding ordinate is found to be

$$y = 0.8856032\dots*$$

In the tables for $L\Gamma(x)$, i.e. $10 + \log \Gamma(x)$, we find in the vicinity of the minimum

x	$L\Gamma(x)$	x	$L\Gamma(x)$
1.45	9.9472677	1.463	9.9472396
1.46	9.9472397	1.47	9.9472539
1.461	9.9472393	1.48	9.9473079
1.462	9.9472392		

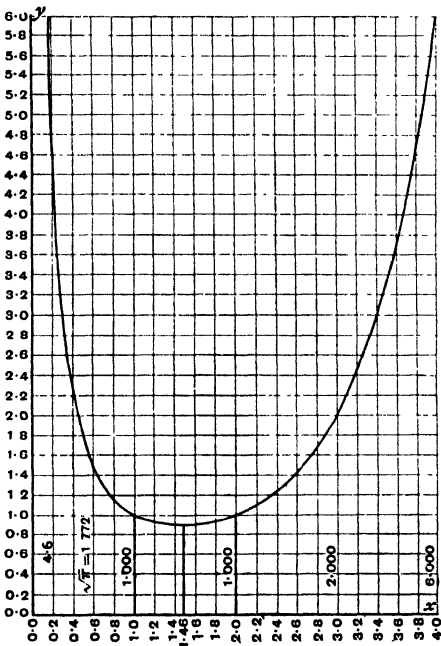

Fig. 320.

So we see from the tables that the minimum ordinate is in the vicinity of 1.462, and the value of the corresponding

* Bertrand gives 0.8856032, page 283, and again page 284, line 3, and the result is given elsewhere. This is evidently an error. The result is given correctly in Serret, *Calc. Intég.*, p. 186.

logarithm, $\bar{1}9472392$, indicates an ordinate 0.885603 approximately. The minimum ordinate is reached, therefore, a little earlier in the march of x from 1 to 2 than the half-way 1.5, which might have been expected from the very rapid fall of value in $\Gamma(x)$ between $\Gamma(0)=\infty$ and $\Gamma(1)=1$ and the much slower rise on passing $x=2$, $\Gamma(2)=1$, $\Gamma(3)=2$, $\Gamma(4)=6$, $\Gamma(5)=24$, etc.

For large values of x , $\frac{\Gamma(x+1)}{x}$ approximates to $\frac{\sqrt{2x\pi}x^xe^{-x}}{x}$,

and the graph of $y=\Gamma(x)$ to the curve $y=\sqrt{\frac{2\pi}{x}}\left(\frac{x}{e}\right)^x$.

We have now seen to what shape the several curves in the graphs in Art. 886 are gradually tending, and comparison should be made between the figures given there and the graph of the limiting form $y=\Gamma(x)$ in Fig. 320 of this article.

923. It will be noted that since $\Gamma(x)$ is decreasing from $x=0$ to $x=1.4616321\dots$ and increasing from $x=1.4616321\dots$ to $x=\infty$ much more slowly, the differences are negative for the first part of the march of $\Gamma(x)$ and positive for the second. Similarly for the differences in the tables which give $\log \Gamma(x)$ or $L\Gamma(x)$. The tabulation is only effected from $x=1$ to $x=2$, for by virtue of the reduction formula $\Gamma(x+1)=x\Gamma(x)$ this is all that is necessary. In using the tables care should be observed with regard to the change of sign of the differences, and those who wish to make close calculations should observe the remarks made by Bertrand, *Calc. Intég.*, p. 284, with regard to the behaviour of the differences both of the first and second orders.

924. The rule of interpolation commonly used is

$$u_x = u_0 + x \Delta u_0 + \frac{x(x-1)}{1 \cdot 2} \Delta^2 u_0 + \dots$$

(Boole, *Finite Differences*, Art. 2),

rather than the ordinary rule of proportional parts, which stops at the second term.

925. Expressions for

$$\frac{d}{dx} \log \Gamma(x), \quad \frac{d^2}{dx^2} \log \Gamma(x), \quad \frac{d^n}{dx^n} \log \Gamma(x), \quad \text{etc.,}$$

as definite integrals.

The expressions for $\frac{d}{dx} \log \Gamma(x)$, $\frac{d^2}{dx^2} \log \Gamma(x)$, etc., viz.

$$\frac{d}{dx} \log \Gamma(x) = Lt_{n=\infty} \left\{ \log n - \left(\frac{1}{x} + \frac{1}{x+1} + \frac{1}{x+2} + \dots + \frac{1}{x+n-1} \right) \right\}, \quad (1)$$

$$\frac{d^2}{dx^2} \log \Gamma(x) = \frac{1}{x^2} + \frac{1}{(x+1)^2} + \frac{1}{(x+2)^2} + \dots \text{ to } \infty, \dots\dots\dots (2)$$

$$\frac{d^n}{dx^n} \log \Gamma(x) = (-1)^n \Gamma(n) \left[\frac{1}{x^n} + \frac{1}{(x+1)^n} + \frac{1}{(x+2)^n} + \dots \text{ to } \infty \right], \quad (3)$$

can readily be converted into definite integrals by aid of the results

$$\int_0^\infty e^{-\beta} \beta^{n-1} d\beta = \frac{\Gamma(n)}{x^n} \dots\dots\dots (a)$$

and $\int_0^\infty \frac{e^{-z} - e^{-kz}}{z} dz = \log k. \dots\dots\dots (b)$

(a) has been proved in Art. 864.

(b) can be established thus:

$$\int_0^\infty e^{-kz} dz = \left[-\frac{e^{-kz}}{k} \right]_0^\infty = \frac{1}{k}.$$

Integrating with regard to k between limits 1 and k ,

$$\log k = \int_0^\infty \left[-\frac{e^{-kz}}{z} \right]_1^k dz = \int_0^\infty \frac{e^{-z} - e^{-kz}}{z} dz.$$

To convert

$$\frac{d}{dx} \log \Gamma(x) = Lt_{n=\infty} \left\{ \log n - \frac{1}{x} - \frac{1}{x+1} - \frac{1}{x+2} - \dots - \frac{1}{x+n-1} \right\},$$

the right side may be written, by aid of (a) and (b),

$$= Lt_{n=\infty} \left[\int_0^\infty \left(\frac{e^{-\beta} - e^{-n\beta}}{\beta} - e^{-\beta x} - e^{-\beta(x+1)} - \dots - e^{-\beta(x+n-1)} \right) d\beta \right]$$

$$= Lt_{n=\infty} \left[\int_0^\infty \left(\frac{e^{-\beta} - e^{-n\beta}}{\beta} - e^{-\beta x} \frac{1 - e^{-n\beta}}{1 - e^{-\beta}} \right) d\beta \right]$$

$$= Lt_{n=\infty} \left[\int_0^\infty \left(\frac{e^{-\beta}}{\beta} - \frac{e^{-x\beta}}{1 - e^{-\beta}} \right) d\beta - \int_0^\infty e^{-n\beta} \left(\frac{1}{\beta} - \frac{e^{-\beta}}{1 - e^{-\beta}} \right) d\beta \right]$$

$$= \int_0^\infty \left(\frac{e^{-\beta}}{\beta} - \frac{e^{-x\beta}}{1 - e^{-\beta}} \right) d\beta, \dots\dots\dots (A)$$

for the second integral disappears when n is made infinite.

926. With regard to $I_0^\infty \equiv \int_0^\infty e^{-n\beta} \left(\frac{1}{\beta} - \frac{e^{-x\beta}}{1-e^{-\beta}} \right) d\beta$, it may be desirable to make a closer investigation, for though for all values of β between ϵ and infinity where ϵ is a given small finite quantity the factor $e^{-n\beta}$ destroys the integrand when n is made infinite, there may be some doubt as to the behaviour of the expression in the immediate proximity of the lower limit.

We note that

$$\frac{1}{\beta} - \frac{e^{-x\beta}}{1-e^{-\beta}} = x - \frac{1}{2} - \left\{ \frac{x(x-1)}{2} + \frac{1}{12} \right\} \beta + \dots,$$

and is finite for all given positive values of x , however small β may be, tending to the finite limit $x - \frac{1}{2}$ when β is indefinitely diminished.

Let K be its greatest numerical value between

$$\beta=0 \quad \text{and} \quad \beta=\epsilon.$$

Then the portion of the integral I between 0 and ϵ does not exceed $K \int_0^\epsilon e^{-n\beta} d\beta$, i.e. $K \frac{1-e^{-n\epsilon}}{n}$, and therefore vanishes in the limit when n is indefinitely increased.

Hence $\int_0^\infty e^{-n\beta} \left\{ \frac{1}{\beta} - \frac{e^{-x\beta}}{1-e^{-\beta}} \right\} d\beta$ vanishes when n is made infinite, for all positive finite values of x .

927. To convert

$$\frac{d^n}{dx^n} \log \Gamma(x) \equiv (-1)^n \Gamma(n) \left[\frac{1}{x^n} + \frac{1}{(x+1)^n} + \frac{1}{(x+2)^n} + \dots \text{ad inf.} \right],$$

the right-hand side may be written by theorem (a),

$$= (-1)^n \int_0^\infty [e^{-x\beta} \beta^{n-1} + e^{-(x+1)\beta} \beta^{n-1} + e^{-(x+2)\beta} \beta^{n-1} + \dots] d\beta;$$

$$\therefore \frac{d^n}{dx^n} \log \Gamma(x) = (-1)^n \int_0^\infty \frac{\beta^{n-1} e^{-x\beta}}{1-e^{-\beta}} d\beta \quad (n \neq 2), \dots \text{(B)}$$

and this includes the case

$$\frac{d^2}{dx^2} \log \Gamma(x) = \int_0^\infty \frac{\beta e^{-x\beta}}{1-e^{-\beta}} d\beta. \dots \text{(C)}$$

928. The same method of treatment will apply in many other cases.

Thus the sum

$$\begin{aligned}
 S_p &= \frac{1}{1^p} + \frac{1}{2^p} + \frac{1}{3^p} + \dots \quad (p > 1) \\
 &= \frac{1}{\Gamma(p)} \int_0^\infty \beta^{p-1} (e^{-\beta} + e^{-2\beta} + e^{-3\beta} + \dots) d\beta \\
 &= \frac{1}{\Gamma(p)} \int_0^\infty \frac{\beta^{p-1} e^{-\beta}}{1 - e^{-\beta}} d\beta \\
 &= \frac{1}{\Gamma(p)} \int_0^\infty \frac{\beta^{p-1} e^{-\frac{\beta}{2}}}{e^{\frac{\beta}{2}} - e^{-\frac{\beta}{2}}} d\beta = 2\Gamma(p) \int_0^\infty \frac{\beta^{p-1} e^{-\frac{\beta}{2}}}{\sinh \frac{\beta}{2}} d\beta. \dots\dots\dots(D)
 \end{aligned}$$

929. Again,

$$\begin{aligned}
 s_p &= \frac{1}{1^p} + \frac{1}{3^p} + \frac{1}{5^p} + \frac{1}{7^p} + \dots \quad (p > 1) \\
 &= \frac{1}{\Gamma(p)} \int_0^\infty \beta^{p-1} (e^{-\beta} + e^{-3\beta} + e^{-5\beta} + \dots) d\beta \\
 &= \frac{1}{\Gamma(p)} \int_0^\infty \frac{\beta^{p-1} e^{-\beta}}{1 - e^{-2\beta}} d\beta = \frac{1}{2\Gamma(p)} \int_0^\infty \frac{\beta^{p-1}}{\sinh \beta} d\beta, \dots\dots\dots(E)
 \end{aligned}$$

Similarly

$$\begin{aligned}
 s_p' &= \frac{1}{1^p} - \frac{1}{3^p} + \frac{1}{5^p} - \frac{1}{7^p} + \dots \\
 &= \frac{1}{\Gamma(p)} \int_0^\infty \frac{\beta^{p-1} e^{-\beta}}{1 + e^{-2\beta}} d\beta = \frac{1}{2\Gamma(p)} \int_0^\infty \frac{\beta^{p-1}}{\cosh \beta} d\beta. \dots\dots\dots(F)
 \end{aligned}$$

And whenever such series occur the conversion to a definite integral form follows at once. For instance, in the expansion (*Diff. Calc.*, Art. 574)

$$\sec x + \tan x = 1 + A_1 \frac{x}{1!} + A_2 \frac{x^2}{2!} + A_3 \frac{x^3}{3!} + \dots,$$

$$A_n = \frac{2^{n+2} n!}{\pi^{n+1}} \left\{ 1 + \left(-\frac{1}{3}\right)^{n+1} + \left(\frac{1}{5}\right)^{n+1} + \left(-\frac{1}{7}\right)^{n+1} + \dots \right\};$$

$$\therefore A_n = 2 \left(\frac{2}{\pi}\right)^{n+1} \int_0^\infty \beta^n [e^{-\beta} + e^{-3\beta} + e^{-5\beta} + e^{-7\beta} + \dots] d\beta, \quad n \text{ odd},$$

$$\text{and } = 2 \left(\frac{2}{\pi}\right)^{n+1} \int_0^\infty \beta^n [e^{-\beta} - e^{-3\beta} + e^{-5\beta} - e^{-7\beta} + \dots] d\beta, \quad n \text{ even};$$

$$A_n = 2 \left(\frac{2}{\pi}\right)^{n+1} \int_0^\infty \frac{\beta^n e^{-\beta}}{1 + (-1)^n e^{-2\beta}} d\beta. \dots\dots\dots(G)$$

Thus the n^{th} Bernoullian number

$$B_{2n-1} = \frac{2n}{2^{2n}(2^{2n}-1)} A_{2n-1} = \frac{2n}{(2^{2n}-1)\pi^{2n}} \int_0^\infty \frac{\beta^{2n-1}}{\sinh \beta} d\beta; \dots \text{(H)}$$

and the n^{th} Eulerian number

$$E_{2n} = A_{2n} = \left(\frac{2}{\pi}\right)^{2n+1} \int_0^\infty \frac{\beta^{2n}}{\cosh \beta} d\beta. \dots \text{(I)}$$

If we write B_{2n-1} as

$$\begin{aligned} B_{2n-1} &= \frac{2(2n)!}{(2\pi)^{2n}} \left[1 + \frac{1}{2^{2n}} + \frac{1}{3^{2n}} + \dots \right] = 2(2n)! \sum_1^\infty \frac{1}{(2r\pi)^{2n}} \\ &= 4n \int_0^\infty \beta^{2n-1} (e^{-2r\beta} + e^{-4r\beta} + e^{-6r\beta} + \dots) d\beta, \end{aligned}$$

we have

$$B_{2n-1} = 4n \int_0^\infty \frac{\beta^{2n-1} e^{-2r\beta}}{1 - e^{-2r\beta}} d\beta = 2n \int_0^\infty \frac{\beta^{2n-1} e^{-r\beta}}{\sinh \pi\beta} d\beta, \dots \text{(J)}$$

a result due to Plana. (*Mem. de l'Acad. de Turin*, 1820.)*

930. **Another Method of obtaining Expressions for $\log \Gamma(x)$, $\frac{d}{dx} \log \Gamma(x)$, $\frac{d^2}{dx^2} \log \Gamma(x)$, ... $\frac{d^n}{dx^n} \log \Gamma(x)$ as Definite Integrals** is as follows:

Differentiating the equation $\Gamma(x) = \int_0^\infty e^{-a} a^{x-1} da$, we have

$$\frac{d\Gamma(x)}{dx} = \int_0^\infty e^{-a} a^{x-1} \log a da. \dots \text{(1)}$$

But
$$\int_0^\infty e^{-az} dz = \left[-\frac{e^{-az}}{a} \right]_0^\infty = \frac{1}{a},$$

and integrating this between limits 1 and a with regard to a ,

$$\log a = \int_0^\infty \frac{e^{-z} - e^{-az}}{z} dz. \dots \text{(2)}$$

$$\begin{aligned} \therefore \frac{d\Gamma(x)}{dx} &= \int_0^\infty e^{-a} a^{x-1} \left\{ \int_0^\infty \frac{e^{-z} - e^{-az}}{z} dz \right\} da \\ &= \int_0^\infty \int_0^\infty a^{x-1} \frac{e^{-a-z} - e^{-a(1+z)}}{z} du dz; \end{aligned}$$

* See Boole, *Fin. Diff.*, p. 110.

and changing the order of integration,

$$= \int_0^\infty \int_0^\infty a^{x-1} \frac{e^{-a-z} - e^{-a(1+z)}}{z} dz da = \Gamma(x) \int_0^\infty \frac{1}{z} \left\{ e^{-z} - \frac{1}{(1+z)^x} \right\} dz;$$

$$\therefore \frac{d \log \Gamma(x)}{dx} = \frac{1}{\Gamma(x)} \frac{d\Gamma(x)}{dx} = \int_0^\infty \frac{1}{z} \left\{ e^{-z} - \frac{1}{(1+z)^x} \right\} dz. \dots(3)$$

Integrating this with regard to x between limits $x=1$ and $x=x$,

$$\log \Gamma(x) = \int_0^\infty \frac{1}{z} \left\{ (x-1)e^{-z} - \frac{(1+z)^{-1} - (1+z)^{-x}}{\log(1+z)} \right\} dz. \dots(4)$$

Putting $x=2$,

$$0 = \int_0^\infty \frac{1}{z} \left\{ e^{-z} - \frac{z(1+z)^{-2}}{\log(1+z)} \right\} dz.$$

Multiply this by $x-1$ and subtract from equation (4);

$$\log \Gamma(x) = \int_0^\infty \left\{ (x-1)(1+z)^{-2} - \frac{(1+z)^{-1} - (1+z)^{-x}}{z} \right\} \frac{dz}{\log(1+z)}. \dots(5)$$

Now put $1+z=e^\beta$,

$$\log \Gamma(x) = \int_0^\infty \left\{ (x-1)e^{-\beta} - \frac{e^{-\beta} - e^{-x\beta}}{1 - e^{-\beta}} \right\} \frac{d\beta}{\beta}. \dots\dots\dots(6)$$

Differentiating this with regard to x ,

$$\frac{d}{dx} \log \Gamma(x) = \int_0^\infty \left(\frac{e^{-\beta}}{\beta} - \frac{e^{-x\beta}}{1 - e^{-\beta}} \right) d\beta; \dots\dots\dots(7)$$

and a further differentiation with regard to x gives

$$\frac{d^2}{dx^2} \log \Gamma(x) = \int_0^\infty \frac{\beta e^{-x\beta}}{1 - e^{-\beta}} d\beta. \dots\dots\dots(8)$$

Differentiating (8) $n-2$ times with regard to x , we get

$$\frac{d^n}{dx^n} \log \Gamma(x) = (-1)^n \int_0^\infty \frac{\beta^{n-1} e^{-x\beta}}{1 - e^{-\beta}} d\beta \quad (n \geq 2) \dots\dots\dots(9)$$

Results (6), (7), (8), (9) give $\log \Gamma(x)$, and its differential coefficients expressed as definite integrals.

From (9), expanding $(1 - e^{-\beta})^{-1}$, we have

$$\begin{aligned} \frac{d^n}{dx^n} \log \Gamma(x) &= (-1)^n \int_0^\infty \beta^{n-1} (e^{-x\beta} + e^{-(x+1)\beta} + e^{-(x+2)\beta} + \dots) d\beta \\ &= (-1)^n \Gamma(n) \left[\frac{1}{x^n} + \frac{1}{(x+1)^n} + \frac{1}{(x+2)^n} + \dots \text{ to } \infty \right], \end{aligned}$$

the formula of Art. 911 (6).

And so far as formulae (7), (8) and (9) are concerned, these definite integral forms are the same as those obtained in Arts. 925 to 927 from the result of Art. 911 (6).

931. Approximate Summation. Maclaurin's Formula.

As we are dealing with many series of the form

$$\frac{1}{1^p} + \frac{1}{2^p} + \frac{1}{3^p} + \dots \quad (p > 1),$$

and other forms in which in some cases an exact summation has not been effected, it is desirable to explain the method usually adopted for approximate evaluation of such summations.

Defining the symbols E , Δ as in *Differential Calculus*, Art. 550, viz. such that

$Eu_x = u_{x+1}$ and $\Delta u_x = u_{x+1} - u_x = Eu_x - u_x$ or $(E-1)u_x$; and also remembering the symbolical form of Taylor's theorem,

$$e^{hD}u_x = u_{x+h}, \text{ where } D \equiv \frac{d}{dx},$$

we have the following identity of operators:

$$E \equiv e^D \equiv \Delta + 1,$$

and it was pointed out in the *Differential Calculus* that these operative symbols obey the same elementary rules of algebra as quantities, viz. the three fundamental rules:

- (a) the associative law,
- (b) the commutative law,
- (c) the index law for positive integral exponents,

with the exception that they are not commutative with regard to variables. Hence, bearing this exception in mind, there is an algebra of operators bearing formal analogy with the ordinary algebra of quantities, and such theorems as the binomial, multinomial or exponential expansions hold.

Let us define another symbol, Σ , to be such that

$$\Sigma u_x = u_{x-1} + u_{x-2} + u_{x-3} + \dots + u_a,$$

where u_a is some fixed term of the series.

$$\text{Then} \quad \Sigma u_{x+1} - \Sigma u_x = u_x,$$

$$\text{i.e.} \quad \Sigma \Delta u_x = u_x,$$

and therefore Σ represents the inverse of the operation Δ ,

which may be written as $\frac{1}{\Delta}$ or Δ^{-1} ; and since $\Delta\{f(x)+C\}$, where C is a constant and $f(x)$ is any function of x , is equal to

$$[f(x+1)+C]-[f(x)+C]=f(x+1)-f(x),$$

so that the constant disappears, so in reversing the process, if such reversal be possible, we must restore the constant, so that we shall regard Σu_x as $\Delta^{-1}u_x+C$ where C is an arbitrary constant to be determined in each special case.

In this respect the symbol of finite summation, or integration, Σ behaves exactly as the sign $\int dx$ of the integral calculus.

$$\text{Thus } \Sigma u_x \equiv C + \frac{1}{E-1} u_x \equiv C + \frac{1}{e^D-1} u_x.$$

Now it has been shown that

$$e^t - 1 = 1 - \frac{t}{2} + \frac{B_1}{2!} t^2 - \frac{B_3}{4!} t^4 + \frac{B_5}{6!} t^6 - \dots \quad (\text{Diff. Calc., Art. 148});$$

whence dividing out by t and writing D in place of t , we have the following equivalence of operators, viz.

$$\frac{1}{e^D-1} \equiv \frac{1}{D} - \frac{1}{2} + \frac{B_1}{2!} D - \frac{B_3}{4!} D^3 + \frac{B_5}{6!} D^5 - \dots,$$

in which all the operations on the right side represent direct differentiations except the first, which represents an integration.

Applying this to any function of x , viz. u_x ,

$$\Sigma u_x = C + \int u_x dx - \frac{1}{2} u_x + \frac{B_1}{2!} \frac{du_x}{dx} - \frac{B_3}{4!} \frac{d^3 u_x}{dx^3} + \frac{B_5}{6!} \frac{d^5 u_x}{dx^5} - \dots$$

For this and many other formulae derived from the same principles, the student may consult Boole, *Finite Differences*, p. 89, etc.

932. Apply this theorem to the case of the series

$$1 + \frac{1}{2} + \frac{1}{3} + \dots + \frac{1}{x}.$$

$$\text{Here } u_x = \frac{1}{x}, \quad \Sigma u_x = 1 + \frac{1}{2} + \frac{1}{3} + \dots + \frac{1}{x-1}.$$

Hence

$$\begin{aligned} 1 + \frac{1}{2} + \frac{1}{3} + \dots + \frac{1}{x} &= \frac{1}{x} + C + \int \frac{dx}{x} - \frac{1}{2x} + \frac{B_1}{2!} \frac{d}{dx} \left(\frac{1}{x} \right) - \frac{B_3}{4!} \frac{d^3}{dx^3} \left(\frac{1}{x} \right) + \dots \\ &= C + \log_e x + \frac{1}{2x} - \frac{B_1}{2} \cdot \frac{1}{x^2} + \frac{B_3}{4} \frac{1}{x^4} - \frac{B_5}{6} \cdot \frac{1}{x^6} + \dots \end{aligned}$$

The constant C must be determined in such examples, either by reference to some known case of the summation, or by absolute calculation of the result for a particular value of x , and when once found, the formula can be used with the determined constant for summation for other values of x .

In the present case, putting $x = \infty$,

$$C = \lim_{x \rightarrow \infty} \left(1 + \frac{1}{2} + \frac{1}{3} + \dots + \frac{1}{x} - \log x \right) = \text{Euler's constant} = \gamma.$$

If this be available (see Art. 897) the series can be used for the calculation of the harmonic series to any degree of approximation required. If C be not available take the case $x=10$, and insert the values of Bernoulli's coefficients, viz.

$$B_1 = \frac{1}{6}, \quad B_3 = \frac{1}{30}, \quad B_5 = \frac{1}{42}, \quad B_7 = \frac{1}{30}, \quad B_9 = \frac{5}{8}, \text{ etc. (see Art. 879).}$$

Now

$$1 + \frac{1}{2} + \frac{1}{3} + \frac{1}{4} + \frac{1}{5} + \frac{1}{6} + \frac{1}{7} + \frac{1}{8} + \frac{1}{9} + \frac{1}{10} = 2.928\ 968\ 254\dots$$

$$\text{Also} \quad \log_e 10 = 2.302\ 585\ 09;$$

$$\therefore 2.928\ 968\ 25\dots - 2.302\ 585\ 09\dots$$

$$= C + \frac{1}{20} - \frac{1}{12} \cdot \frac{1}{10^2} + \frac{1}{120} \cdot \frac{1}{10^4} - \frac{1}{252} \cdot \frac{1}{10^6} + \frac{1}{240} \cdot \frac{1}{10^8} - \dots$$

$$\cdot 626\ 383\ 16\dots = C + \cdot 049\ 167\ 496;$$

$$\therefore C = \cdot 577\ 215\ 66\dots \quad (\text{Euler's constant}),$$

which is correct to eight places of decimals.

Hence to the same degree of approximation we may now proceed to sum the series to any other number of terms by the result

$$1 + \frac{1}{2} + \dots + \frac{1}{x} = \cdot 57721566\dots + \log_e x + \frac{1}{2x} - \frac{B_1}{2} \frac{1}{x^2} + \frac{B_3}{4} \frac{1}{x^4} - \text{etc.} \dots$$

It will be noted that to obtain eight decimal places of Euler's constant only three of the terms on the right-hand side affected the result.

933. Take the case

$$\frac{1}{1^n} + \frac{1}{2^n} + \frac{1}{3^n} + \frac{1}{4^n} + \dots + \frac{1}{x^n} \quad (n > 1).$$

Here

$$u_n = \frac{1}{x^n},$$

$$\begin{aligned} \Sigma u_n + \frac{1}{x^n} &= \frac{1}{x^n} + C + \int \frac{dx}{x^n} - \frac{1}{2} \frac{1}{x^n} + \frac{B_1}{2!} \frac{d}{dx} \frac{1}{x^n} - \frac{B_2}{4!} \frac{d^2}{dx^2} \left(\frac{1}{x^n} \right) + \frac{B_3}{6!} \frac{d^3}{dx^3} \left(\frac{1}{x^n} \right) - \dots \\ &= \frac{1}{x^n} + C - \frac{1}{n-1} \frac{1}{x^{n-1}} - \frac{1}{2x^n} - \frac{n}{12} \frac{1}{x^{n+1}} + \frac{n(n+1)(n+2)}{720} \frac{1}{x^{n+2}} - \dots \end{aligned}$$

except in the case $n=1$, when $\log x$ replaces $-\frac{1}{n-1} \frac{1}{x^{n-1}}$.

Hence
$$\frac{1}{1^n} + \frac{1}{2^n} + \frac{1}{3^n} + \dots + \frac{1}{x^n} \quad (n > 1)$$

$$= C - \frac{1}{n-1} \frac{1}{x^{n-1}} + \frac{1}{2} \frac{1}{x^n} - \frac{n}{12} \frac{1}{x^{n+1}} + \frac{n(n+1)(n+2)}{720} \frac{1}{x^{n+2}} - \text{etc.},$$

and this series can be calculated to any degree of approximation when C has been found.

In the case when n is even, the exact sums for an infinite number of terms are known for the earlier values of n . The values for $n=2, 4, 6, 8, 10$ are given in Art. 879.

When this is the case the exact value of C is known, e.g. if $n=2$, $C = \frac{\pi^2}{6}$ (Euler), and

$$\frac{1}{1^2} + \frac{1}{2^2} + \dots + \frac{1}{x^2} = \frac{\pi^2}{6} - \frac{1}{x} + \frac{1}{2x^2} - \frac{1}{6} \frac{1}{x^3} + \frac{1}{30} \frac{1}{x^5} - \frac{1}{42} \frac{1}{x^7} + \text{etc.}$$

If $n=4$, $C = \frac{\pi^4}{90}$ (Euler), and for even values of n higher than 10,

C can be found from $C = \frac{(2\pi)^{2n}}{2(2n)!} B_{2n-1}$. (See Art. 879.)

934. For odd indices we proceed as in Art. 932, and the value of the constant is to be calculated, as it is not available otherwise.

Thus, if $n=3$,

$$\frac{1}{1^3} + \frac{1}{2^3} + \frac{1}{3^3} + \dots + \frac{1}{x^3} = C - \frac{1}{2x^2} + \frac{1}{2x^3} - \frac{1}{4} \frac{1}{x^4} + \frac{1}{12} \frac{1}{x^5} - \frac{1}{12} \frac{1}{x^6} + \dots$$

Take the case $x=10$. It will be found to give $C=1.202056903\dots$ to the first nine places of decimals, and to that approximation with this value of C the formula can be used for finding the sum of any other number of terms.

The value of C is the sum to infinity, in all these examples, viz.

$$\sum_{r=1}^{\infty} \frac{1}{r^n}, \text{ except when } n=1, \text{ a case which has been considered.}$$

935. Consider finally the case

$$\log 1 + \log 2 + \log 3 + \dots + \log x.$$

Here

$$u_x = \log x;$$

$$\begin{aligned} \therefore \log(x!) &= C + \log x + \int \log x \, dx - \frac{1}{2} \log x + \frac{1}{6} \frac{1}{2!} \frac{d}{dx} \log x \\ &\quad - \frac{1}{30} \frac{1}{4!} \frac{d^3}{dx^3} \log x + \frac{1}{42} \frac{1}{6!} \frac{d^5}{dx^5} (\log x) - \dots \\ &= C + \log x + x(\log x - 1) - \frac{1}{2} \log x + \frac{1}{12} \frac{1}{x} - \frac{1}{360} \frac{1}{x^3} + \frac{1}{1260} \frac{1}{x^5} - \dots \\ &= C - x + x \log x + \frac{1}{2} \log x + \frac{1}{12} \frac{1}{x} - \frac{1}{360} \frac{1}{x^3} + \frac{1}{1260} \frac{1}{x^5} - \dots, \end{aligned}$$

and when x is made very large

$$\log(\sqrt{2\pi x} x^x e^{-x}) = C + x \log x + \frac{1}{2} \log x - x;$$

$$\therefore C = \log \sqrt{2\pi};$$

$$\therefore \log(1 \cdot 2 \cdot 3 \dots x) = \frac{1}{2} \log 2\pi - x + \left(x + \frac{1}{2}\right) \log x + \frac{1}{12} \frac{1}{x} - \frac{1}{360} \frac{1}{x^3} + \frac{1}{1260} \frac{1}{x^5} - \dots,$$

$$\text{i.e. } 1 \cdot 2 \cdot 3 \dots x = \sqrt{2\pi x} x^x e^{-x} e^{\frac{1}{12x}} e^{-\frac{1}{360x^3}} e^{\frac{1}{1260x^5}} \dots, *$$

$$\text{i.e. } 1 \cdot 2 \cdot 3 \dots x = \sqrt{2\pi x} x^x e^{-x} \left[1 + \frac{1}{12x} + \frac{1}{288x^2} - \frac{139}{51840x^3} \dots\right]$$

as a close approximation. (Cf. Arts. 877, 884.)

936. It will be seen that the formula

$$\Sigma u_x = C + \int u_x \, dx - \frac{1}{2} u_x + \frac{B_1}{2!} \frac{du_x}{dx} - \text{etc.}$$

will be of the greatest service when methods of exact summation fail. The student should, however, test the formula for himself in cases with known results, such as

$$1^3 + 2^3 + \dots + x^3 = \frac{x^2(x+1)^2}{4},$$

to gain familiarity with it.

Enough has been said to show that the summations we require in the present chapter, such as

$$S_r = \frac{1}{1^r} + \frac{1}{2^r} + \frac{1}{3^r} + \dots + \frac{1}{x^r} \quad (r > 1),$$

can be readily calculated, when wanted, to any degree of approximation which may be required, without the labour of calculating out each term separately, except for a few terms to determine the value of the constant. We have, for finding C , chosen 10 terms for the obvious reason that the arithmetical calculations of the right-hand member of the equality are thereby much simplified.

* See De Morgan, *Differential Calculus*, p. 312.

937. **A Theorem due to Cauchy.**

It is a well-known theorem in trigonometry that

$$\cot z = \frac{1}{z} - \sum_1^m \frac{2z}{r^2\pi^2 - z^2} + R_m,$$

where R_m is a quantity which may be made as small as we please by taking m large enough (see Hobson, *Trigonometry*, Art. 293). This is so whether z is real or complex. Also, when m is indefinitely increased the series is absolutely convergent for all values of z , with the exception of such as are expressed by $z = \pm r\pi$ for integral values of r .

Writing $\frac{iz}{2}$ in place of z , we have

$$\frac{1}{2} \coth \frac{z}{2} = \frac{1}{z} + \sum_1^m \frac{2z}{4r^2\pi^2 + z^2} + R'_m,$$

where R'_m , like R_m , can be made indefinitely small by increasing m without limit, and

$$\frac{1}{2} \coth \frac{z}{2} = \frac{1}{2} \left(\frac{e^z + 1}{e^z - 1} \right),$$

and can be written either as

$$\frac{1}{e^z - 1} + \frac{1}{2} \quad \text{or as} \quad \frac{e^z}{e^z - 1} - \frac{1}{2}, \quad \text{i.e.} \quad \frac{1}{1 - e^{-z}} - \frac{1}{2}.$$

Hence $\left. \begin{array}{l} \frac{1}{e^z - 1} + \frac{1}{2} - \frac{1}{z} \\ \text{or} \quad \frac{1}{1 - e^{-z}} - \frac{1}{2} - \frac{1}{z} \end{array} \right\} = \sum_1^m \frac{2z}{4r^2\pi^2 + z^2} + R'_m.$

Now, by division,

$$\frac{1}{a^2 + z^2} = \frac{1}{a^2} - \frac{z^2}{a^4} + \frac{z^4}{a^6} - \dots + (-1)^{n-1} \frac{z^{2n-2}}{a^{2n}} + (-1)^n \frac{z^{2n}}{a^{2n+2}} \epsilon,$$

where $\epsilon = \frac{a^2}{a^2 + z^2}$ and is a positive proper fraction for all real values of z , and the series would be convergent, and could be continued to infinity, provided $z < a$ if real, or mod. $z < a$ if z be complex.

Write in this identity $a = 2\pi, 4\pi, 6\pi \dots 2m\pi$ successively, and indicate by suffixes 1, 2, 3, ..., the corresponding values of ϵ , and let S_r^m denote

$$\frac{1}{1^r} + \frac{1}{2^r} + \frac{1}{3^r} + \dots + \frac{1}{m^r}.$$

Then we arrive at m equations of the type

$$\frac{1}{(2r\pi)^2 + z^2} = \frac{1}{(2r\pi)^2} - \frac{z^2}{(2r\pi)^4} + \dots + (-1)^{n-1} \frac{z^{2n-2}}{(2r\pi)^{2n}} + (-1)^n \frac{z^{2n}}{(2r\pi)^{2n+2}} \epsilon_r,$$

and, adding these equations together,

$$\sum_1^m \frac{1}{4r^2\pi^2 + z^2} = \frac{S_2^m}{(2\pi)^2} - \frac{S_4^m z^2}{(2\pi)^4} + \dots + (-1)^{n-1} \frac{S_{2n}^m z^{2n-2}}{(2\pi)^{2n}} + \frac{(-1)^n S_{2n+2}^m z^{2n}}{(2\pi)^{2n+2}} \epsilon',$$

where
$$\epsilon' S_{2n+2}^m = \sum_1^m \frac{\epsilon_r}{r^{2n+2}},$$

and if η be the greatest of the quantities $\epsilon_1, \epsilon_2, \dots$,

$$\epsilon' S_{2n+2}^m < \eta \sum_1^m \frac{1}{r^{2n+2}}, \quad \text{i.e. } \epsilon' < \eta,$$

and therefore ϵ' is also, like $\epsilon_1, \epsilon_2, \epsilon_3, \dots$, a positive proper fraction.

We thus have, taking e^z to have its principal value,

$$\left(\frac{1}{e^z - 1} + \frac{1}{2} - \frac{1}{z} \right) = \frac{2S_2^m}{(2\pi)^2} z - \frac{2S_4^m}{(2\pi)^4} z^3 + \frac{2S_6^m}{(2\pi)^6} z^5 - \dots$$

$$+ (-1)^{n-1} \frac{2S_{2n}^m}{(2\pi)^{2n}} z^{2n-1} + (-1)^n \frac{2S_{2n+2}^m}{(2\pi)^{2n+2}} z^{2n+1} \epsilon' + R'_m,$$

and if we increase m without limit, the series S_2^m, S_4^m, S_6^m , being all convergent,

$$Lt_{m \rightarrow \infty} S_r^m = \frac{1}{r} + \frac{1}{2r} + \dots \text{ to } \infty = S_r, \quad \text{and } Lt R'_m = 0.$$

Hence

$$\left(\frac{1}{e^z - 1} + \frac{1}{2} - \frac{1}{z} \right) = \frac{2S_2}{(2\pi)^2} z - \frac{2S_4}{(2\pi)^4} z^3 + \frac{2S_6}{(2\pi)^6} z^5 - \dots$$

$$+ (-1)^{n-1} \frac{2S_{2n}}{(2\pi)^{2n}} z^{2n-1} + (-1)^n \frac{2S_{2n+2}}{(2\pi)^{2n+2}} z^{2n+1} \Theta.$$

where Θ is a positive proper fraction; or, what is the same thing, $\left(\frac{1}{1 - e^{-z}} - \frac{1}{2} - \frac{1}{z} \right) =$ the same expression.

And if we write $\frac{B_{2n-1}}{(2n)!}$ for $\frac{2S_{2n}}{(2\pi)^{2n}}$, we have

$$\left. \begin{aligned} & \frac{1}{z} \left(\frac{1}{e^z - 1} + \frac{1}{2} - \frac{1}{z} \right) \\ \text{or} & \frac{1}{z} \left(\frac{1}{1 - e^{-z}} - \frac{1}{2} - \frac{1}{z} \right) \end{aligned} \right\} = \frac{B_1}{2!} - \frac{B_3}{4!} z^2 + \frac{B_5}{6!} z^4 - \dots + (-1)^{n-1} \frac{B_{2n-1}}{(2n)!} z^{2n-2}$$

$$+ (-1)^n \frac{B_{2n+1}}{(2n+2)!} z^{2n},$$

where $0 < \Theta < 1$ for all real values of z .

938. Now Cauchy has shown that Maclaurin's Theorem for the expansion of a continuous function of x , viz. $F(x)$, for the case of a real variable, still holds for a complex variable which is such that its modulus has a value lower than that for which $F(x)$ ceases to be finite or continuous (see Art. 1299).

The function $\frac{1}{e^z-1} + \frac{1}{2} - \frac{1}{z}$ only becomes infinite for values of z which are given by $z=2\lambda i\pi$, where λ is a positive or negative integer other than zero. This function is therefore capable of expansion by Maclaurin's Theorem in a convergent series within the circle of convergence of radius 2π for any real or complex value of z , whose modulus is $<2\pi$, and the form of that expansion has been given in *Diff. Calc.*, Art. 148, as

$$\frac{1}{z} \left(\frac{1}{e^z-1} + \frac{1}{2} - \frac{1}{z} \right) = \frac{B_1}{2!} - \frac{B_3}{4!} z^2 + \frac{B_5}{6!} z^4 - \dots \text{ to infinity}$$

or
$$\frac{z}{e^z-1} = 1 - \frac{z}{2} + \frac{B_1}{2!} z^2 - \frac{B_3}{4!} z^4 + \frac{B_5}{6!} z^6 - \dots,$$

and the various coefficients were defined as Bernoulli's numbers.

This series then is convergent when z is a real variable which lies between -2π and $+2\pi$, exclusive. It is also true and convergent when z is a complex variable and z lies within a circle of convergence of radius 2π .

And when the infinite series is not convergent, *i e.* when z does not lie between the limits specified, the series may be stopped at any term $(-1)^{n-1} \frac{B_{2n-1}}{(2n)!} z^{2n-2}$, and the error is then numerically less than the next term, $(-1)^n \frac{B_{2n+1}}{(2n+2)!} z^{2n}$.

This theorem is due to Cauchy.

939. Lemma. As a preliminary to what follows we may remark that such an integral as $\int_a^x \frac{\theta}{x^p} dx$, where $0 < \theta < 1$, lies intermediate between $\theta_1 \int_a^x \frac{1}{x^p} dx$ and $\theta_2 \int_a^x \frac{1}{x^p} dx$, where θ_1 and θ_2 are the greatest and least values of θ between $x=a$ and $x=x$. Therefore $\int_a^x \frac{\theta}{x^p} dx = \Theta \int_a^x \frac{dx}{x^p}$ for some value of Θ between θ_1 and θ_2 , and therefore, if θ_1 and θ_2 are positive proper fractions, so also must Θ be a positive proper fraction.

940. Now we have established the equation

$$\psi'(x) \equiv \frac{d^2}{dx^2} \log \Gamma(x) = \int_0^\infty \frac{\beta e^{-x\beta}}{1 - e^{-\beta}} d\beta \quad (\text{Art. 930, 8});$$

or, what is the same thing,

$$\psi'(x+1) \equiv \frac{d^2}{dx^2} \log \Gamma(x+1) = \int_0^\infty \frac{\beta e^{-(x+1)\beta}}{1 - e^{-\beta}} d\beta = \int_0^\infty e^{-x\beta} \frac{\beta}{e^\beta - 1} d\beta.$$

Hence, substituting for $\frac{\beta}{e^\beta - 1}$, the finite series established by Cauchy (Art. 937),

$$\begin{aligned} \psi'(x+1) \equiv \frac{d^2}{dx^2} \log \Gamma(x+1) &= \int_0^\infty e^{-x\beta} \left[1 - \frac{\beta}{2} + \frac{B_1}{2!} \beta^2 - \frac{B_3}{4!} \beta^4 + \dots \right. \\ &\quad \left. + (-1)^{n-1} \frac{B_{2n-1}}{(2n)!} \beta^{2n} + (-1)^n \frac{B_{2n+1}}{(2n+2)!} \beta^{2n+2} \Theta \right] d\beta, \\ &\quad (0 < \Theta < 1), \end{aligned}$$

$$\begin{aligned} &= \frac{1}{x} - \frac{1}{2} \cdot \frac{\Gamma(2)}{x^2} + \frac{B_1}{2!} \frac{\Gamma(3)}{x^3} - \frac{B_3}{4!} \frac{\Gamma(5)}{x^5} + \dots + (-1)^{n-1} \frac{B_{2n-1}}{(2n)!} \frac{\Gamma(2n+1)}{x^{2n+1}} \\ &\quad + (-1)^n \frac{B_{2n+1}}{(2n+2)!} \frac{\Gamma(2n+3)}{x^{2n+3}} \Theta, \quad (0 < \Theta < 1), \end{aligned}$$

i.e.

$$\begin{aligned} \psi'(x+1) \equiv \frac{d^2}{dx^2} \log \Gamma(x+1) &= \frac{1}{x} - \frac{1}{2x^2} + \frac{B_1}{x^3} - \frac{B_3}{x^5} + \dots \\ &\quad + (-1)^{n-1} \frac{B_{2n-1}}{x^{2n+1}} + (-1)^n \frac{B_{2n+1}}{x^{2n+3}} \Theta, \quad (0 < \Theta < 1). \end{aligned}$$

Integrating this result,

$$\begin{aligned} \psi(x+1) \equiv \frac{d}{dx} \log \Gamma(x+1) &= A + \log x + \frac{1}{2x} - \frac{B_1}{2x^2} + \frac{B_3}{4x^4} - \dots \\ &\quad - (-1)^{n-1} \frac{B_{2n-1}}{2n x^{2n}} - (-1)^n \frac{B_{2n+1}}{(2n+2)x^{2n+2}} \Theta_1, \end{aligned}$$

where $0 < \Theta_1 < 1$, by the lemma of the last article, A being a constant to be determined.

Let x become infinite. Then

$$\begin{aligned} A = \lim_{x \rightarrow \infty} \left[\frac{\Gamma'(x+1)}{\Gamma(x+1)} - \log x \right] &= \lim_{x \rightarrow \infty} \left[\frac{\Gamma'(x+1)}{\Gamma(x+1)} - \log(x+1) \right] \\ &\quad + \lim_{x \rightarrow \infty} \log \left(1 + \frac{1}{x} \right) = 0, \quad \text{by Art. 911 (3).} \end{aligned}$$

Hence

$$\begin{aligned} \psi(x+1) &\equiv \frac{d}{dx} \log \Gamma(x+1) = \log x + \frac{1}{2x} - \frac{B_1}{2x^2} + \frac{B_3}{4x^4} - \dots \\ &\quad - (-1)^{n-1} \frac{B_{2n-1}}{2n x^{2n}} - (-1)^n \frac{B_{2n+1}}{(2n+2)x^{2n+2}} \Theta_1, \end{aligned}$$

($0 < \Theta_1 < 1$).

Again integrating,

$$\begin{aligned} \log \Gamma(x+1) &= A' + x(\log x - 1) + \frac{1}{2} \log x + \frac{B_1}{1 \cdot 2} \frac{1}{x} - \frac{B_3}{3 \cdot 4} \cdot \frac{1}{x^3} + \dots \\ &\quad + (-1)^{n-1} \frac{B_{2n-1}}{(2n-1)2n} \frac{1}{x^{2n-1}} + (-1)^n \frac{B_{2n+1}}{(2n+1)(2n+2)} \frac{1}{x^{2n+1}} \Theta_2, \end{aligned}$$

($0 < \Theta_2 < 1$), by the lemma, where A' is a constant to be determined.

Let x become an infinite integer,

$$\begin{aligned} A' &= Lt_{x \rightarrow \infty} [\log \Gamma(x+1) - x(\log x - 1) - \frac{1}{2} \log x] \\ &= Lt_{x \rightarrow \infty} [\log(\sqrt{2x\pi} x^x e^{-x}) - (x + \frac{1}{2}) \log x + x] \\ &= \log \sqrt{2\pi}. \end{aligned}$$

Hence

$$\begin{aligned} \log \Gamma(x+1) &= \frac{1}{2} \log 2\pi + (x + \frac{1}{2}) \log x - x + \frac{B_1}{1 \cdot 2} \frac{1}{x} - \frac{B_3}{3 \cdot 4} \frac{1}{x^3} + \dots \\ &\quad + (-1)^{n-1} \frac{B_{2n-1}}{(2n-1)2n} \frac{1}{x^{2n-1}} + (-1)^n \frac{B_{2n+1}}{(2n+1)(2n+2)} \frac{1}{x^{2n+1}} \Theta_2, \end{aligned}$$

($0 < \Theta_2 < 1$).

This result is also due to Cauchy.

941. The series, if carried to infinity, is known as Stirling's Series. It is divergent, however great x may be. For the general term

$$\frac{B_{2n-1}}{(2n-1)2n} \frac{1}{x^{2n-1}} = \frac{1}{(2n-1)2n} \cdot \frac{1}{x^{2n-1}} \frac{2(2n)!}{(2\pi)^{2n}} S_{2n},$$

and the ratio of this term to the preceding term is

$$\frac{(2n-3)(2n-2)}{(2\pi x)^2} \times \frac{S_{2n}}{S_{2n-2}},$$

i.e. ultimately $\frac{n^2}{\pi^2 x^2}$, and however great x may be, will ultimately be > 1 when n is large enough. The formula can, nevertheless, be made useful for approximative purposes for calculating $\Gamma(x+1)$. For, as in the series of Art. 938, the

error in stopping at the term involving $\frac{1}{x^{2n-1}}$ has been shown to be $\Theta \frac{B_{2n+1}}{(2n+1)(2n+2)} \frac{1}{x^{2n+1}}$ ($0 < \Theta < 1$), *i.e.* the error is less than the succeeding term. And as the ratio of two consecutive terms, *viz.* $\frac{(2n-3)(2n-2)}{(2\pi x)^2} \frac{S_{2n-1}}{S_{2n-2}}$, is less than unity until $(2n-3)(2n-2) \frac{S_{2n}}{S_{2n-2}}$ exceeds $4\pi^2 x^2$, the absolute values of the several terms go on diminishing until this happens, and then increase again. Hence the closest approximation will be obtained by continuing the series until that term is reached which precedes the smallest term.

942. We have as successive approximations

$$\log \Gamma(x+1) > \frac{1}{2} \log 2\pi + (x + \frac{1}{2}) \log x - x,$$

$$\log \Gamma(x+1) < \frac{1}{2} \log 2\pi + (x + \frac{1}{2}) \log x - x + \frac{B_1}{1 \cdot 2} \frac{1}{x},$$

$$\log \Gamma(x+1) > \frac{1}{2} \log 2\pi + (x + \frac{1}{2}) \log x - x + \frac{B_1}{1 \cdot 2} \frac{1}{x} - \frac{B_3}{3 \cdot 4} \frac{1}{x^3},$$

$$\log \Gamma(x+1) < \frac{1}{2} \log 2\pi + (x + \frac{1}{2}) \log x - x + \frac{B_1}{1 \cdot 2} \frac{1}{x} - \frac{B_3}{3 \cdot 4} \frac{1}{x^3} + \frac{B_5}{5 \cdot 6} \frac{1}{x^5}, \text{ etc.}$$

And since $B_1 = \frac{1}{6}$, $B_3 = \frac{1}{30}$, $B_5 = \frac{1}{42}$, etc.,

$\Gamma(x+1)$

$$> \sqrt{2\pi x} x^x e^{-x},$$

$$< \sqrt{2\pi x} x^x e^{-x} e^{\frac{1}{12x}},$$

$$> \sqrt{2\pi x} x^x e^{-x} e^{\frac{1}{12x} - \frac{1}{360x^3}}, \text{ etc.,}$$

i.e.

$\Gamma(x+1)$

$$> \sqrt{2\pi x} x^x e^{-x},$$

$$< \sqrt{2\pi x} x^x e^{-x} \left(1 + \frac{1}{12x} + \frac{1}{288x^2} \dots \right),$$

$$> \sqrt{2\pi x} x^x e^{-x} \left(1 + \frac{1}{12x} + \frac{1}{2(12x)^2} - \frac{139}{30(12x)^3} - \frac{571}{120(12x)^4} \dots \right),$$

etc.

943. In order to facilitate calculation from the series

$$\log \Gamma(x+1) = \frac{1}{2} \log 2\pi + \left(x + \frac{1}{2}\right) \log x - x + \frac{B_1}{1 \cdot 2} \cdot \frac{1}{x} - \frac{B_3}{3 \cdot 4} \frac{1}{x^3} + \frac{B_5}{5 \cdot 6} \frac{1}{x^5} - \dots,$$

it is desirable to arrange so that x shall not be small.

For this purpose Legendre puts $x = 4 + a$; whence

$$\log \Gamma(x+1) = \log x + \log \Gamma(x) = \log x + \log \Gamma(a) + \log a(a+1)(a+2)(a+3)$$

and

$$\log_{10} \Gamma(a) = \frac{1}{2} \log_{10} 2\pi + \left(x - \frac{1}{2}\right) \log_{10} x - \mu x + \frac{\mu B_1}{1 \cdot 2} \frac{1}{x} - \frac{\mu B_3}{3 \cdot 4} \frac{1}{x^3} + \frac{\mu B_5}{5 \cdot 6} \frac{1}{x^5} - \dots - \log_{10} a(a+1)(a+2)(a+3),$$

where μ is the modulus of the logarithm tables, viz.

$$\mu = \log_{10} e = .4342944819 \dots$$

Thus, if $\log_{10} \Gamma(1.25)$ be required, $x = 5.25$, and

$$\log_{10} \Gamma(1.25) = \frac{1}{2} \log_{10} 2\pi + 4.75 \log_{10} 5.25 - \mu 5.25 + \frac{\mu}{12} \frac{1}{5.25} - \text{etc.} - \log_{10} [(1.25)(2.25)(3.25)(4.25)],$$

and by this artifice it is possible to avoid the calculation of all but the earlier terms of the series. We could make $x = 5 + a$, $6 + a$, ..., equally well, and the choice is in the hands of the calculator.

Legendre remarks as to his calculations of the seven-figure tables of $\log \Gamma(x)$ with regard to the above: "de cette manière on n'a jamais eu besoin de calculer plus de deux ou trois termes de la série $\frac{m A'}{1 \cdot 2k} - \frac{m B'}{3 \cdot 4k^2} + \frac{m C'}{5 \cdot 6k^5} - \text{etc.}$, pour avoir $\log \Gamma(a)$ approché jusqu'à sept décimales, dans tout l'intervalle depuis $a = 1$ jusqu'à $a = 2$ " (*Exercices*, p. 300).

Legendre's m , k , A' , B' , C' are what we have called μ , x , B_1 , B_3 , B_5 respectively.

944. **The Case when x is a Commensurable Number.**

We have established the result

$$\frac{d}{dx} \log \Gamma(x) = \int_0^\infty \left(\frac{e^{-\beta}}{\beta} - \frac{e^{-\beta x}}{1 - e^{-\beta}} \right) d\beta. \quad (\text{Art. 930 (7).})$$

And we have seen that Euler's constant γ is the value of

$$-\frac{d}{dx} \log \Gamma(x) \quad \text{when } x=1 \quad (\text{Art. 911 (4)})$$

that is
$$\gamma = -\int_0^{\infty} \left(\frac{e^{-\beta}}{\beta} - \frac{e^{-\beta}}{1-e^{-\beta}} \right) d\beta.$$

Hence, adding

$$\frac{d}{dx} \log \Gamma(x) + \gamma = \int_0^{\infty} \frac{e^{-\beta} - e^{-\beta x}}{1-e^{-\beta}} d\beta.$$

In the case when x is a commensurable number* this integral can be reduced to the integration of a rational integral algebraic expression, and the integration effected in finite terms in terms of the ordinary algebraic, logarithmic and inverse circular functions.

Let $x = \frac{p}{q}$, where p and q are positive integers, and let $e^{-\beta} = t^q$.

Then
$$\frac{d}{dx} \log \Gamma(x) + \gamma = q \int_0^1 \frac{t^q - t^{pq}}{t(1-t^q)} dt,$$

and the integrand is a rational integral algebraic function of t .

If $q=1$, i.e. if x be an integer, the value of $\frac{d}{dx} \log \Gamma(x)$ is given by

$$\begin{aligned} \frac{d}{dx} \log \Gamma(x) + \gamma &= \int_0^1 \frac{1-t^{x-1}}{1-t} dt \\ &= \int_0^1 (1+t+t^2+\dots+t^{x-2}) dt \\ &= \frac{1}{1} + \frac{1}{2} + \frac{1}{3} + \dots + \frac{1}{x-1}, \end{aligned}$$

as might be expected from Art. 911 (2).

945. Expansion of $\Gamma(x+1)$ derived from the Integral Definition (De Morgan).

The expansion of $\log \Gamma(1+x)$ in powers of x may be obtained directly from the definition of $\Gamma(1+x)$ as $\int_0^{\infty} e^{-v} v^x dv$.

For we have
$$Lt_{a=0} \left(\frac{1-e^{-av}}{a} \right)^x = v^x.$$

Hence
$$\Gamma(1+x) = Lt_{a=0} \int_0^{\infty} \frac{e^{-v} (1-e^{-av})^x}{a^x} dv.$$

* See Serret, *Calc. Intégral*, p. 184.

Let $e^{-av} = y$. Then $a dv = -\frac{dy}{y}$, and

$$\begin{aligned}\Gamma(1+x) &= Lt \frac{1}{a^{x+1}} \int_0^1 y^{a^{-1}} (1-y)^x dy \\ &= Lt \frac{1}{a^{x+1}} B\left(\frac{1}{a}, x+1\right) \quad \left(\text{Let } \frac{1}{a} = b, \text{ a positive integer.}\right) \\ &= Lt_{b=\infty} b^{x+1} \frac{\Gamma(b)\Gamma(x+1)}{\Gamma(b+x+1)},\end{aligned}$$

$$i.e. \quad Lt_{b=\infty} b^{x+1} \frac{\Gamma(b)}{\Gamma(x+b+1)} = 1;$$

$$\therefore Lt_{b=\infty} \frac{(x+b)(x+b-1) \dots (x+1) \Gamma(x+1)}{(b-1)(b-2) \dots 1 \cdot b^{x+1}} = 1,$$

i.e.

$$\log \Gamma(1+x) = Lt \left[x \log b - \log\left(1 + \frac{x}{1}\right) - \log\left(1 + \frac{x}{2}\right) - \dots \text{ad inf.} \right],$$

or, expanding the logarithms, assuming $x < 1$,

$$\begin{aligned}\log \Gamma(1+x) &= Lt \left[-\left(\frac{1}{1} + \frac{1}{2} + \frac{1}{3} + \dots + \frac{1}{b} - \log b\right)x \right. \\ &\quad \left. + \frac{1}{2}\left(\frac{1}{1^2} + \frac{1}{2^2} + \dots + \frac{1}{b^2}\right)x^2 - \frac{1}{3}\left(\frac{1}{1^3} + \frac{1}{2^3} + \dots + \frac{1}{b^3}\right)x^3 + \dots \right],\end{aligned}$$

and when b is indefinitely increased

$$\log \Gamma(1+x) = -\gamma x + S_2 \frac{x^2}{2} - S_3 \frac{x^3}{3} + S_4 \frac{x^4}{4} - \dots$$

for values of x , $0 < x < 1$.

This investigation is due to De Morgan.*

It was felt desirable to deduce this series directly from the integral, rather than to base it upon results deduced from the property $\Gamma(x+1) = x\Gamma(x)$, *i.e.* the difference equation $u_{x+1} = xu_x$, inasmuch as Legendre's tables of the values of the Gamma function are derived from this series and others obtained from it. And in default of direct derivation of the series from the integral itself, some doubt might be felt as to whether Legendre's tabulated results were the values of the integral itself or the values of the integral multiplied by some periodic function of x whose period is unity, which, as explained in Art. 863, would equally be a solution of the difference equation.

* De Morgan, *Diff. Calc.*, p. 584.

946. From De Morgan's investigation given above, the formal identification of $\Gamma(x+1)$ with $\Pi(x)$ for all positive values of x , may proceed as follows:

$$\Pi(x) = Lt_{\mu=\infty} \mu^x \left/ \left(1 + \frac{x}{1}\right) \left(1 + \frac{x}{2}\right) \dots \left(1 + \frac{x}{\mu}\right) \right.;$$

$$\therefore \log \Pi(x) = Lt_{\mu=\infty} \left[x \log \mu - \log \left(1 + \frac{x}{1}\right) - \log \left(1 + \frac{x}{2}\right) - \dots - \log \left(1 + \frac{x}{\mu}\right) \right],$$

and if $x < 1$, $= -\gamma x + \frac{S_2}{2} x^2 - \frac{S_3}{3} x^3 + \dots$;

$\therefore \Pi(x) = \Gamma(x+1)$ if $x < 1$ and positive.

If x lies between 1 and 2, say $x = 1 + \xi$, then, since

$$\left. \begin{aligned} \Pi(1 + \xi) &= (1 + \xi) \Pi(\xi) \\ \text{and } \Gamma(2 + \xi) &= (1 + \xi) \Gamma(1 + \xi) \end{aligned} \right\} \text{and } \Pi(\xi) = \Gamma(1 + \xi) \quad (0 < \xi < 1),$$

it follows that $\Pi(1 + \xi) = \Gamma(2 + \xi)$,

i.e. $\Pi(x) = \Gamma(1 + x)$ when x lies between 1 and 2.

Similarly if x lies between 2 and 3, etc.

Hence, for all positive values of x , $\Pi(x)$ and $\Gamma(1 + x)$ are identical.

947. **The Integration of** $\int_0^a e^{-v} v^n dv$, (a not infinite, $n > -1$).

In considering the integration of $e^{-v} v^n dv$ between limits 0 and a , where a is not infinite, we must have recourse to either

(1) an expression in series

or (2) a continued fraction.

$$\begin{aligned} (1) \quad I_n &\equiv \int_0^a e^{-v} v^n dv = \left[\frac{e^{-v} v^{n+1}}{n+1} \right]_0^a + \frac{1}{n+1} \int_0^a e^{-v} v^{n+1} dv \\ &= \frac{e^{-a} a^{n+1}}{n+1} + \frac{1}{n+1} I_{n+1}, \end{aligned}$$

and by the continued use of this rule,

$$\begin{aligned} I_n &= \frac{e^{-a} a^{n+1}}{n+1} \left[1 + \frac{a}{n+2} + \frac{a^2}{(n+2)(n+3)} + \frac{a^3}{(n+2)(n+3)(n+4)} \right. \\ &\quad \left. + \dots \text{ad inf.} \right], \end{aligned}$$

a series which is always convergent for any finite value of α , but only slowly so if α be > 1 . A little consideration will show that the integral remainder is ultimately infinitely small. Or we may proceed thus :

$$\begin{aligned} \text{Let } J_n &\equiv \int_a^\infty e^{-v} v^n dv = \left[-e^{-v} v^n \right]_a^\infty + n J_{n-1} \\ &= e^{-a} \alpha^n + n J_{n-1}; \end{aligned}$$

whence

$$\begin{aligned} J_n &= e^{-a} \alpha^n \left[1 + \frac{n}{\alpha} + \frac{n(n-1)}{\alpha^2} + \dots + \frac{n(n-1)\dots(n-r+1)}{\alpha^r} \right] \\ &\quad + n(n-1)\dots(n-r) J_{n-r-1}. \end{aligned}$$

If n be a positive integer, the integration can be effected in finite terms. But if n be negative or fractional, the series on the right-hand side is divergent if continued to infinity whatever α may be. The terms however ultimately take alternate signs, and when such is the case, and when there is convergence for a certain number of terms, and then ultimate divergence, we can apply the principle adopted in Arts. 938, 941, the convergent part making a continual approximation to the arithmetical value of the function under consideration, and the error being less than the first term omitted.*

If then J_n be thus approximated to,

$$I_n = \int_0^a e^{-v} v^n dv = \left(\int_0^\infty - \int_a^\infty \right) e^{-v} v^n dv,$$

and

$$I_n = \Gamma(n+1) - J_n.$$

948. (2) De Morgan has shown how such an integral as $\int_c^\infty e^{-v} v^n dv$ can be converted into a continued fraction.

When this is done $\int_0^r e^{-v} v^n dv = \Gamma(n+1) - \int_r^\infty e^{-v} v^n dv$, as before.

Let $\int_0^\infty e^{-v} v^n dv = e^{-r} v^n V$, where V is some function of v .

Then differentiating with regard to r ,

$$-e^{-r} v^n = e^{-r} v^n V' + n e^{-r} v^{n-1} V - e^{-r} v^n V;$$

$$\therefore rV' + nV - vV = -r,$$

or

$$vV' = (v-n)V - v.$$

Consider the equation

$$vV' = (v-a_1)V - v + b_1V^2. \dots\dots\dots(1)$$

*De Morgan, *Differential Calculus*, p. 226 and p. 590.

Putting $V = \frac{1}{1 + k_1 \frac{1}{v}}$, we derive an equation

$$vV_1' = (v - a_2)V_1 - v + b_2V_1^2, \dots\dots\dots(2)$$

where $b_1 - a_1 = k_1, \quad b_2 = k_1 = b_1 - a_1, \quad a_2 = -(a_1 + 1).$

Putting $V_1 = \frac{1}{1 + k_2 \frac{1}{v^2}}$ in equation (2), we derive an equation

$$vV_2' = (v - a_2)V_2 - v + b_2V_2^2, \dots\dots\dots(3)$$

where $b_2 - a_2 = k_2, \quad b_3 = k_2, \quad a_3 = -(a_2 + 1),$

and so on.

Then
$$r = \frac{1}{1 +} \frac{k_1 v^{-1}}{1 +} \frac{k_2 v^{-1}}{1 +} \frac{k_3 v^{-1}}{1 +} \text{ etc.}$$

In our case

$a_1 = n,$	$b_1 = 0,$	$k_1 = -n = b_2;$
$a_2 = -(1 + n),$	$b_2 = -n,$	$k_2 = 1 = b_3;$
$a_3 = n,$	$b_3 = 1,$	$k_3 = -(n - 1) = b_4;$
$a_4 = -(n + 1),$	$b_4 = -(n - 1),$	$k_4 = 2 = b_5;$
$a_5 = n,$	$b_5 = 2,$	$k_5 = 2 - n = b_6;$
	etc. ;	

whence

$$\int_0^\infty e^{-v} v^n dv = e^{-r} v^n \left[\frac{1}{1 -} \frac{nv^{-1}}{1 +} \frac{v^{-1}}{1 -} \frac{(n-1)v^{-1}}{1 +} \frac{2v^{-1}}{1 -} \frac{(n-2)v^{-1}}{1 +} \text{ etc.} \right].$$

The expression converges rapidly for large values of v .

The process above employed by De Morgan is similar to that employed by Boole, *Differential Equations*, p. 92, in the solution of Riccati's equation

$$x \frac{dy}{dx} - ay + by^2 = cx^n.$$

The equation we have just solved is a very similar equation, viz.

$$x \frac{dy}{dx} + a_1 y - b_1 y^2 = -x + xy.$$

949. More generally, consider the differential equation

$$P + Qy + Ry^2 + S \frac{dy}{dx} = 0,$$

where P, Q, R, S are functions of x alone.

Let $X_1 = Ax^a, \quad X_2 = Bx^\beta, \quad X_3 = Cx^\gamma, \text{ etc.}$

Take y_1, y_2, y_3, \dots successive new dependent variables, such that

$$y = \frac{X_1}{1 + y_1}, \quad y_1 = \frac{X_2}{1 + y_2}, \quad y_2 = \frac{X_3}{1 + y_3}, \text{ etc.}$$

Then when $A, B, C, \dots a, \beta, \gamma, \dots$ have been properly determined, we have

$$y = \frac{Ax^a}{1 +} \frac{Bx^\beta}{1 +} \frac{Cx^\gamma}{1 +} \dots'$$

viz. a solution in the form of a continued fraction. [LACROIX, t. II., p. 288.]

To begin with, using accents for differentiations,

$$y' = \frac{X'_1(1+y_1) - X_1y'_1}{(1+y_1)^2};$$

$$\therefore P + Q \frac{X_1}{1+y_1} + R \frac{X_1^2}{(1+y_1)^2} + S \frac{X'_1(1+y_1) - X_1y'_1}{(1+y_1)^2} = 0,$$

i.e. $(P + QX_1 + RX_1^2 + SX'_1) + (2P + QX_1 + SX'_1)y_1 + Py_1^2 - SX_1y'_1 = 0,$

or

$$P_1 + Q_1y_1 + R_1y_1^2 + S_1y'_1 = 0,$$

where

$$\left. \begin{aligned} P_1 &\equiv P + QX_1 + RX_1^2 + SX'_1, \\ Q_1 &\equiv 2P + QX_1 \quad + SX'_1, \\ R_1 &\equiv P, \\ S_1 &\equiv -SX_1. \end{aligned} \right\}$$

At the second substitution, viz. $y_1 = \frac{X_2}{1+y_2}$, the differential equation becomes

$$P_2 + Q_2y_2 + R_2y_2^2 + S_2y'_2 = 0,$$

where P_2, Q_2, R_2, S_2 are formed from P_1, Q_1, R_1, S_1 in the same way as the latter were formed from P, Q, R, S , and so on.

Again assuming the expansion of y in powers of x to be of the form $Ax^\alpha + A_1x^{\alpha+1} + \dots$ and the expansion of y_1 to be $Bx^\beta + B_1x^{\beta+1} + \dots$, and so on, we can by substitution in the several differential equations they satisfy obtain the values of A and α, B and β , etc., by an examination of the lowest order terms occurring, and thus express y in the form of a continued fraction.

950. Development of $\psi(a+x) \equiv \frac{d}{dx} \log \Gamma(a+x)$ in a Factorial Series.

Since

$$\begin{aligned} \Delta \psi(a+x) &= \psi(a+x+1) - \psi(a+x) = \frac{d}{dx} [\log \Gamma(a+x+1) - \log \Gamma(a+x)] \\ &= \frac{d}{dx} \log(a+x) = \frac{1}{a+x}, \end{aligned}$$

we have

$$\Delta^2 \psi(a+x) = \Delta \frac{1}{a+x} = \frac{1}{a+x+1} - \frac{1}{a+x} = \frac{(-1)}{(a+x)(a+x+1)},$$

$$\Delta^3 \psi(a+x) = \Delta^2 \frac{1}{a+x} = \frac{(-1)(-2)}{(a+x)(a+x+1)(a+x+2)},$$

and generally

$$\Delta^n \psi(a+x) = \Delta^{n-1} \frac{1}{a+x} = \frac{(-1)^{n-1} (n-1)!}{(a+x)(a+x+1) \dots (a+x+n-1)}.$$

Let

$$\psi(a+x) = A_0 + A_1 \frac{x^{(1)}}{1!} + A_2 \frac{x^{(2)}}{2!} + A_3 \frac{x^{(3)}}{3!} + \dots + A_n \frac{x^{(n)}}{n!} + \dots,$$

where $x^{(n)} \equiv x(x-1) \dots (x-n+1)$.

Then
$$\Delta\psi(a+x) = A_1 + A_2 \frac{x^{(1)}}{1!} + A_3 \frac{x^{(2)}}{2!} + \dots,$$

$$\Delta^2\psi(a+x) = A_2 + A_3 \frac{x^{(1)}}{1!} + A_4 \frac{x^{(2)}}{2!} + \dots,$$

etc.

Hence

$$A_0 = \psi(a+0), \quad A_1 = \Delta\psi(a+0), \quad A_2 = \Delta^2\psi(a+0), \dots \text{ etc.},$$

where $\Delta^n\psi(a+0)$ means the value of $\Delta^n\psi(a+x)$ when x is put = 0.

Hence

$$\begin{aligned} \psi(a+x) \equiv \frac{d}{dx} \log \Gamma(a+x) = \psi(a) + \frac{x}{a} - \frac{1}{2} \frac{x(x-1)}{a(a+1)} + \frac{1}{3} \frac{x(x-1)(x-2)}{a(a+1)(a+2)} \\ - \frac{1}{4} \frac{x(x-1)(x-2)(x-3)}{a(a+1)(a+2)(a+3)} + \dots, \end{aligned}$$

a series which will terminate in the case when x is a positive integer and is in any case convergent for real and positive values of x and a .

The value of $\psi(a)$, i.e. $\frac{d}{da} \log_e \Gamma(a)$, can be found for any particular value of a by means of the series

$$\frac{d}{dx} \log_e \Gamma(x+1) = \log_e x + \frac{1}{2x} - \frac{B_1}{2x^2} + \frac{B_3}{4x^4} - \text{etc.}$$

of Art. 940.

951. In the case when $a=1$, we have

$$\begin{aligned} \psi(1+x) = \psi(1) + \frac{x}{1!} - \frac{1}{2} \frac{x(x-1)}{2!} + \frac{1}{3} \frac{x(x-1)(x-2)}{3!} \\ - \frac{1}{4} \frac{x(x-1)(x-2)(x-3)}{4!} + \dots \end{aligned}$$

and

$$-\psi(1) = \gamma \text{ (Euler's constant).}$$

Since $\Delta x^{(n)} = nx^{(n-1)}$, this may be written symbolically as

$$\psi(1+x) = -\gamma + \Delta \left(\frac{1}{\Delta} - \frac{1}{2\Delta^2} + \frac{1}{3\Delta^3} - \dots \right) x = -\gamma + \Delta \log \left(1 + \frac{1}{\Delta} \right) x,$$

i.e.
$$\frac{d}{dx} \log \Gamma(1+x) = -\gamma + \Delta \log \left(\frac{E}{\Delta} \right) x.$$

952. Other properties of the ψ function are :

Since $\Gamma(x+1) = x\Gamma(x)$, we have by logarithmic differentiation

$$\psi(x+1) - \psi(x) = \frac{1}{x}. \dots\dots\dots(a)$$

Since $\Gamma(x)\Gamma(1-x) = \frac{\pi}{\sin x\pi}$, we have similarly

$$\psi(x) - \psi(1-x) = -\pi \cot x\pi. \dots\dots\dots(b)$$

Since $2^{2x}\Gamma(x)\Gamma(\frac{1}{2}+x) = 2\sqrt{\pi}\Gamma(2x)$, we have similarly

$$\psi(x) + \psi(\frac{1}{2}+x) = 2\psi(2x) - 2 \log 2. \dots\dots\dots(c)$$

Since $2 \Gamma(x) \Gamma\left(\frac{1-x}{2}\right) = \frac{2^x \sqrt{\pi}}{\cos \frac{x\pi}{2}} \Gamma\left(\frac{x}{2}\right)$, we have similarly

$$\psi(x) - \frac{1}{2}\psi\left(\frac{1-x}{2}\right) = \frac{1}{2}\psi\left(\frac{x}{2}\right) + \log 2 + \frac{\pi}{2} \tan \frac{x\pi}{2}. \dots\dots\dots(d)$$

Since $\Gamma(x) \Gamma\left(x + \frac{1}{n}\right) \Gamma\left(x + \frac{2}{n}\right) \dots \Gamma\left(x + \frac{n-1}{n}\right) = n^{-nx+\frac{1}{2}} (2\pi)^{\frac{n-1}{2}} \Gamma(nx)$, we have similarly

$$\psi(x) + \psi\left(x + \frac{1}{n}\right) + \psi\left(x + \frac{2}{n}\right) + \dots + \psi\left(x + \frac{n-1}{n}\right) = n\psi(nx) - n \log n. (e)$$

953. The equation $\Delta\psi(a+x) = \frac{1}{a+x}$ is of considerable service in summation of series.

1. A sum of the form

$$\begin{aligned} & \frac{1}{a+b} + \frac{1}{a+2b} + \frac{1}{a+3b} + \dots \text{ to } n \text{ terms, viz.} \\ S = \sum_{r=1}^{r=n} \frac{1}{a+rb} & \text{ can be written} \\ = \frac{1}{b} \sum_1^n \frac{1}{\frac{a}{b}+r} & = \frac{1}{b} \sum \Delta\psi\left(\frac{a}{b}+r\right) \\ = \frac{1}{b} \left[\psi\left(\frac{a}{b}+r\right) \right]_1^{n+1} & = \frac{1}{b} \left[\psi\left(\frac{a}{b}+n+1\right) - \psi\left(\frac{a}{b}+1\right) \right]. \end{aligned}$$

2. A sum of the form

$$\begin{aligned} S &= \frac{1}{a+b} - \frac{1}{a+2b} + \frac{1}{a+3b} - \frac{1}{a+4b} + \dots \text{ to } 2n \text{ terms} \\ &= \frac{1}{2b} \sum_1^n \frac{1}{\frac{a-b}{2b}+r} - \frac{1}{2b} \sum_1^n \frac{1}{\frac{a}{2b}+r} \\ &= \frac{1}{2b} \sum_1^n \Delta\psi\left(\frac{a-b}{2b}+r\right) - \frac{1}{2b} \sum_1^n \Delta\psi\left(\frac{a}{2b}+r\right) \\ &= \frac{1}{2b} \left[\psi\left(\frac{a-b}{2b}+r\right) \right]_1^{n+1} - \frac{1}{2b} \left[\psi\left(\frac{a}{2b}+r\right) \right]_1^{n+1}. \end{aligned}$$

E.g. (a) $\frac{1}{1} + \frac{1}{3} + \frac{1}{5} + \frac{1}{7} + \dots + \frac{1}{2n-1}$

$$= \frac{1}{2} \sum_0^{n-1} \frac{1}{\frac{1}{2}+r} = \frac{1}{2} \sum_0^{n-1} \Delta\psi\left(\frac{1}{2}+r\right) = \frac{1}{2} \left[\psi\left(\frac{1}{2}+r\right) \right]_0^n = \frac{1}{2} \left[\psi\left(\frac{1}{2}+n\right) - \psi\left(\frac{1}{2}\right) \right].$$

(b) $\frac{1}{1} - \frac{1}{3} + \frac{1}{5} - \frac{1}{7} + \dots$ ad inf.

$$\begin{aligned} &= \frac{1}{2} \sum_0^\infty \frac{1}{\frac{1}{2}+r} - \frac{1}{2} \sum_0^\infty \frac{1}{\frac{3}{2}+r} \\ &= \frac{1}{2} \sum \Delta\psi\left(\frac{1}{2}+r\right) - \frac{1}{2} \sum \Delta\psi\left(\frac{3}{2}+r\right) \\ &= \frac{1}{2} \left[\psi\left(\frac{1}{2}+r\right) \right]_0^\infty - \frac{1}{2} \left[\psi\left(\frac{3}{2}+r\right) \right]_0^\infty \\ &= \frac{1}{2} \left[\psi\left(\frac{3}{2}\right) - \psi\left(\frac{1}{2}\right) \right]. \end{aligned}$$

But by (b) ($x = \frac{3}{4}$), $\psi(\frac{3}{4}) - \psi(\frac{1}{4}) = \pi$;

$$\therefore \text{the series is } = \frac{\pi}{4},$$

which is well known otherwise, being Gregory's series for $\tan^{-1} 1$.

3. Sum the series

$$S = \frac{1}{1} - \frac{1}{2} + \frac{1}{3} - \frac{1}{4} + \frac{1}{5} - \dots \text{ ad inf.}$$

Here

$$\begin{aligned} S &= \frac{1}{2} \sum_0^{\infty} \frac{1}{\frac{1}{2} + r} - \frac{1}{2} \sum_0^{\infty} \frac{1}{1+r} \\ &= \frac{1}{2} \sum \Delta \psi(\frac{1}{2} + r) - \frac{1}{2} \sum \Delta \psi(1+r) \\ &= \frac{1}{2} \left[\psi(\frac{1}{2} + r) \right]_0^{\infty} - \frac{1}{2} \left[\psi(1+r) \right]_0^{\infty} \\ &= \frac{1}{2} [\psi(1) - \psi(\frac{1}{2})]. \end{aligned}$$

Now by (c) ($x = \frac{1}{2}$), $\psi(1) + \psi(\frac{1}{2}) = 2\psi(1) - 2 \log 2$;

$$\therefore \psi(1) - \psi(\frac{1}{2}) = 2 \log 2;$$

$\therefore S = \log 2$, which is well known otherwise.

We may note that it follows that

$$\begin{aligned} \psi(\frac{1}{2}) &= \psi(1) - 2 \log 2 = -\gamma - 2 \log 2 \\ &= -0.5772157 - 1.3862944 \\ &= -1.9635101\dots \end{aligned}$$

$$\begin{aligned} \text{By (c), } \psi(\frac{1}{4}) + \psi(\frac{3}{4}) &= 2\psi(\frac{1}{2}) - 2 \log 2 = 2\{\psi(1) - 2 \log 2\} - 2 \log 2 \\ &= -2\gamma - 6 \log 2 \end{aligned}$$

and $\psi(\frac{3}{4}) - \psi(\frac{1}{4}) = \pi$.

$$\text{Hence } \psi(\frac{3}{4}) = \frac{\pi}{2} - \gamma - 3 \log 2,$$

$$\psi(\frac{1}{4}) = -\frac{\pi}{2} - \gamma - 3 \log 2$$

and $\psi(\frac{1}{2}) = -\gamma - 2 \log 2.$

954. Gauss has established a remarkable result, giving for the function $\psi(x)$ the value of $\psi(1-x) + \psi(x)$ in a series of trigonometric terms in the case when x is any commensurable proper fraction. This result taken with

$$\psi(1-x) - \psi(x) = \pi \cot x\pi$$

will enable us to calculate the value of $\psi(x)$ in all such cases.

The theorem is given by Bertrand in Art. 307 of his *Calcul Intégral*.

For shortness we shall denote

$$\log x \text{ by } Lx, \quad \psi\left(\frac{r}{q}\right) \text{ by } \psi_r, \quad \cos r\theta \text{ by } c_r, \quad \log 4 \sin^2 \frac{r\theta}{2} \text{ by } L_r.$$

Then when $\theta = \frac{2\pi}{q}$ or $\frac{4\pi}{q}$ or $\frac{6\pi}{q}$... or $\frac{2(q-1)\pi}{q}$,

$$c_q = c_{2q} = c_{3q} = \dots = 1; \quad c_{q+r} = c_{2q+r} = \dots = c_r; \quad c_1 + c_2 + \dots + c_q \equiv \sum c_r = 0.$$

Writing the fundamental equation

$$\psi(x) = Lt_{n=\infty} \left[\log n - \frac{1}{x} - \frac{1}{x+1} - \frac{1}{x+2} - \dots - \frac{1}{x+n-1} \right] \text{ as}$$

$$\psi(x) = \left(l1 - \frac{1}{x} \right) + \left(l \frac{2}{1} - \frac{1}{x+1} \right) + \dots + \left(l \frac{n}{n-1} - \frac{1}{x+n-1} \right) + \left(l \frac{n+1}{n} - \frac{1}{x+n} \right) + \dots,$$

and putting $x = \frac{r}{q}$, where $r \nmid q$, and both are positive integers, we have

$$\psi_r = \left(l1 - \frac{q}{r} \right) + \left(l \frac{2}{1} - \frac{q}{q+r} \right) + \dots + \left(l \frac{n}{n-1} - \frac{q}{(n-1)q+r} \right) + \left(l \frac{n+1}{n} - \frac{q}{nq+r} \right) + \dots \quad (A)$$

Taking $r=1, 2, 3, \dots, q$ in this equation, multiplying by $\cos \theta, \cos 2\theta, \cos 3\theta, \dots, \cos q\theta$ respectively, and adding, we get

$$\sum_1^q c_r \psi_r = \left(\sum_1^q c_r l1 - \sum_1^q \frac{c_r}{r} \right) + \left(\sum_1^q c_r l \frac{2}{1} - \sum_1^q \frac{c_r}{q+r} \right) + \dots + \left(\sum_1^q c_r l \frac{n+1}{n} - \sum_1^q \frac{c_r}{nq+r} \right) + \dots$$

Now the coefficients of $\log 1, \log \frac{2}{1}, \log \frac{3}{2}$, etc., all vanish and since $c_r = c_{q+r}$, etc., the remaining terms form a continuous series to infinity, viz.

$$-q \left[\sum_1^q \frac{c_r}{r} + \sum_1^q \frac{c_{q+r}}{q+r} + \sum_1^q \frac{c_{2q+r}}{2q+r} + \dots \right] = -q \sum_1^{\infty} \frac{c_r}{r} = \frac{q}{2} \log 4 \sin^2 \frac{\theta}{2} = \frac{q}{2} L_1;$$

$$\therefore \sum_1^q c_r \psi_r = \frac{q}{2} L_1,$$

viz. an equation connecting $\psi_1, \psi_2, \psi_3, \dots, \psi_{q-1}, \psi_q$, the last of which terms is $\psi\left(\frac{q}{q}\right) = \psi(1) = -\gamma$, where γ is Euler's constant. That is

$$c_1 \psi_1 + c_2 \psi_2 + c_3 \psi_3 + \dots + c_{q-1} \psi_{q-1} = \frac{q}{2} L_1 + \gamma.$$

So far θ has stood for any of the quantities $\frac{2\pi}{q}, \frac{4\pi}{q}, \dots$ or $2\frac{q-1}{q}\pi$. Say the first. Then similar results will hold for the rest, i.e. if we take $2\theta, 3\theta, \dots, (q-1)\theta$ in place of θ . We thus get $q-1$ linear equations from which we can find $\psi\left(\frac{1}{q}\right), \psi\left(\frac{2}{q}\right), \dots, \psi\left(\frac{q-1}{q}\right)$, viz.

$$\left. \begin{aligned} c_1 \psi_1 + c_2 \psi_2 + \dots + c_p \psi_p + \dots + c_{q-p} \psi_{q-p} + \dots + c_{q-1} \psi_{q-1} &= \frac{q}{2} L_1 + \gamma, \\ c_2 \psi_1 + c_4 \psi_2 + \dots + c_{2p} \psi_p + \dots + c_{2(q-p)} \psi_{q-p} + \dots + c_{2(q-1)} \psi_{q-1} &= \frac{q}{2} L_2 + \gamma, \\ c_3 \psi_1 + c_6 \psi_2 + \dots + c_{3p} \psi_p + \dots + c_{3(q-p)} \psi_{q-p} + \dots + c_{3(q-1)} \psi_{q-1} &= \frac{q}{2} L_3 + \gamma, \\ \dots & \dots \\ c_{q-1} \psi_1 + \dots + c_{(q-1)p} \psi_p + \dots + c_{(q-1)(q-p)} \psi_{q-p} + \dots + c_{(q-1)(q-1)} \psi_{q-1} &= \frac{q}{2} L_{q-1} + \gamma; \end{aligned} \right\}$$

and in addition we have

$$c_q \psi_1 + c_{2q} \psi_2 + \dots + c_{qp} \psi_p + \dots + c_{q(q-p)} \psi_{q-p} + \dots + c_{q(q-1)} \psi_{q-1} = -(q-1)\gamma - q \log q,$$

which is merely a case of the identity (e) of Art. 952, for the coefficients $\cos q\theta, \cos 2q\theta$, etc., each = 1.

To solve these equations we multiply them, and the identity, respectively by $c_p, c_{2p}, c_{3p}, \dots, c_{qp}$.

Now note that $c_\lambda c_\mu + c_{2\lambda} c_{2\mu} + c_{3\lambda} c_{3\mu} + \dots + c_{q\lambda} c_{q\mu}$ for any integral values of λ, μ (the last term being unity, since $q\theta = a$ a multiple of 2π)

$$= \frac{1}{2} \sum_1^q c_{(\lambda+\mu)r} + \frac{1}{2} \sum_1^q c_{(\lambda-\mu)r};$$

and that each of these sums is zero, except in the two cases $\lambda \pm \mu = a$ a multiple of q , and that in the cases we have to consider λ and μ each range in value from 0 to $q-1$. Hence the only cases of this kind are when $\lambda = \mu$ or $\lambda = q - \mu$, and both would happen if $\lambda = \mu = q - \mu$, i.e. if q be even, and $\lambda = \mu = \frac{q}{2}$.

$$\text{If } \lambda = \mu, \frac{1}{2} \sum_1^q c_{(\lambda-\mu)r} = \frac{1}{2} \sum_1^q 1 = \frac{q}{2}; \quad \text{if } \lambda = q - \mu, \frac{1}{2} \sum_1^q c_{(\lambda+\mu)r} = \frac{1}{2} \sum_1^q 1 = \frac{q}{2},$$

and when q is even and $\lambda = \mu = \frac{q}{2}$, $\frac{1}{2} \sum_1^q c_{(\lambda+\mu)r} + \frac{1}{2} \sum_1^q c_{(\lambda-\mu)r} = q$.

The latter case will occur when, q being even and therefore $q-1$ odd, there is a middle term in the system of unknowns, viz. $\psi_p = \psi_{q-p} = \psi(\frac{1}{2})$, and the case need not be distinguished from the others. Thus, after multiplication by $c_p, c_{2p}, \dots, c_{qp}$ and addition, the coefficients of all the unknowns vanish except those of ψ_p and ψ_{q-p} , and the coefficients of these terms are each $\frac{q}{2}$; and if $q-1$ be odd and $p = \frac{q}{2}$, all vanish except that of $\psi(\frac{1}{2})$, which is the middle unknown of the series, and the coefficient of this term will be q .

And on the right-hand side we have

$$\begin{aligned} & \frac{q}{2} (c_p L_1 + c_{2p} L_2 + \dots + c_{(q-1)p} L_{q-1}) + \gamma (c_p + c_{2p} + \dots + c_{qp}) - q\gamma c_{qp} - q \log q \cdot c_{qp} \\ & = \frac{q}{2} (c_p L_1 + c_{2p} L_2 + \dots + c_{(q-1)p} L_{q-1}) - q\gamma - q \log q. \end{aligned}$$

In the bracket, terms equidistant from the ends pair, but if q be even there will be an unpaired term left in the middle of the series. This term is $\frac{q}{2} \cos \frac{q}{2} p\theta \log 4 \sin^2 \frac{q\theta}{4}$ which reduces, since $q\theta = 2\pi$, to $q(-1)^p \log 2$.

Hence the right-hand side becomes

$$q \left(c_p L_1 + c_{2p} L_2 + \dots + c_{\frac{q-1}{2}p} L_{\frac{q-1}{2}} \right) - q\gamma - q \log q \quad (q \text{ odd}),$$

or $q \left(c_p L_1 + c_{2p} L_2 + \dots + c_{\frac{q-2}{2}p} L_{\frac{q-2}{2}} \right) - q\gamma - q \log q + q(-1)^p \log 2 \quad (q \text{ even}).$

We thus have

$$\psi \left(1 - \frac{p}{q} \right) + \psi \left(\frac{p}{q} \right) = 2 \left\{ \sum_1^{(q-1)/2} c_{rp} L_r - \gamma - \log q \right\} \quad (q \text{ odd}),$$

or $= 2 \left\{ \sum_1^{(q-2)/2} c_{rp} L_r - \gamma - \log q + (-1)^p \log 2 \right\} \quad (q \text{ even}),$

and this, as pointed out above with

$$\psi \left(1 - \frac{p}{q} \right) - \psi \left(\frac{p}{q} \right) = \pi \cot \frac{p}{q} \pi,$$

will enable us by addition and subtraction to obtain both

$$\psi\left(1 - \frac{p}{q}\right) \text{ and } \psi\left(\frac{p}{q}\right)$$

for any integral values of p and q ($p < q$).

It will be observed that these theorems give the tangents of the slopes of the curve $y = \log \Gamma(x)$ at equal distances on opposite sides of the ordinate at $x = 0.5$.

Ex. If $p = 1, q = 3,$

$$\psi\left(\frac{2}{3}\right) - \psi\left(\frac{1}{3}\right) = \pi \cot \frac{\pi}{3} = \frac{\pi}{\sqrt{3}},$$

$$\begin{aligned} \psi\left(\frac{2}{3}\right) + \psi\left(\frac{1}{3}\right) &= 2 \left[-\gamma - \log 3 + \cos \frac{2\pi}{3} \log 4 \sin^2 \frac{\pi}{3} \right] \\ &= 2 \left[-\gamma - \log 3 - \frac{1}{2} \log 3 \right] \\ &= -2\gamma - 3 \log 3; \end{aligned}$$

$$\therefore \left. \begin{aligned} \psi\left(\frac{2}{3}\right) &= -\gamma - \frac{3}{2} \log 3 + \frac{\pi}{2\sqrt{3}}, \\ \psi\left(\frac{1}{3}\right) &= -\gamma - \frac{3}{2} \log 3 - \frac{\pi}{2\sqrt{3}}. \end{aligned} \right\}$$

955. LIST OF RESULTS.

As the results obtained in the present chapter are very numerous and necessarily scattered over many pages in the gradual development of the theory of Eulerian integrals, it may be convenient to the reader to have the principal facts arrived at collected together for ready reference. A synopsis is therefore added in two groups, the second group referring more particularly to the ψ function, which entails some repetition.

GROUP I.

1. $B(l, m) = B(m, l) = \int_0^1 x^{l-1} (1-x)^{m-1} dx.$ (Art. 857.)

2. If l, m be positive integers, $B(l, m) = \frac{(l-1)!(m-1)!}{(l+m-1)!}.$

If l only be a positive integer,

$$B(l, m) = \frac{(l-1)!}{m(m+1)\dots(m+l-1)}. \quad (\text{Art. 858.})$$

3. $B(l, m) = \int_0^\infty \frac{x^{m-1}}{(1+x)^{l+m}} dx = \int_0^\infty \frac{x^{l-1}}{(1+x)^{l+m}} dx.$ (Art. 859 (2).)

4. $\int_b^a (x-b)^{l-1} (a-x)^{m-1} dx = (a-b)^{l+m-1} B(l, m).$
(Art. 859 (4).)

5. $\int_0^{\frac{\pi}{2}} \sin^p \theta \cos^q \theta d\theta = \frac{\Gamma\left(\frac{p+1}{2}\right)\Gamma\left(\frac{q+1}{2}\right)}{2\Gamma\left(\frac{p+q}{2}+1\right)}$. (Arts. 859, 869.)
6. $\int_0^{\frac{\pi}{2}} \frac{\sin^{2l-1} \theta \cos^{2m-1} \theta}{(a \cos^2 \theta + b \sin^2 \theta)^{l+m}} d\theta = \frac{1}{2a^m b^l} B(l, m)$. (Arts. 859, 869.)
7. $\Gamma(n) = \int_0^\infty x^{n-1} e^{-x} dx$, $\frac{\Gamma(n)}{k^n} = \int_0^\infty x^{n-1} e^{-kx} dx$,
 $\Gamma\left(1+\frac{1}{r}\right) = \prod_{i=1}^\infty \frac{\left(1+\frac{1}{r}\right)^x}{\left(1+\frac{x}{r}\right)}$, $\Pi(x) = Lt_{\mu=\infty} \frac{1 \cdot 2 \dots \mu}{(n+1)(n+2)\dots(n+\mu)} \mu^x$,
 (Arts. 854, 864, 874, 889.)
8. $\Gamma(n+1) = n\Gamma(n) = \Pi(n)$.
 $\Pi(n+1) = (n+1)\Pi(n)$. (Arts. 860, 890.)
9. $\Gamma\left(\frac{1}{2}\right) = \sqrt{\pi} = \Pi\left(-\frac{1}{2}\right)$. (Arts. 864, 882.)
10. $\Gamma(x)\Gamma(1-x) = \pi \operatorname{cosec} x\pi = \Pi(-x)\Pi(x-1)$.
 $\Gamma(1+x)\Gamma(1-x) = x\pi \operatorname{cosec} x\pi$. (Arts. 872, 893.)
11. $\int_0^\pi \frac{x^{l-1}}{1+x} dx = \frac{\pi}{\sin l\pi}$ ($0 < l < 1$). (Art. 871.)
12. $\Gamma\left(\frac{1}{n}\right)\Gamma\left(\frac{2}{n}\right)\Gamma\left(\frac{3}{n}\right)\dots\Gamma\left(\frac{n-1}{n}\right) = \frac{(2\pi)^{\frac{n-1}{2}}}{n^{\frac{1}{2}}}$. (Art. 873.)
13. $n^{nx}\Gamma(x)\Gamma\left(x+\frac{1}{n}\right)\Gamma\left(x+\frac{2}{n}\right)\dots\Gamma\left(x+\frac{n-1}{n}\right) = \Gamma(nx)(2\pi)^{\frac{n-1}{2}} n^{\frac{1}{2}}$,
 $\Gamma(x)\Gamma\left(x+\frac{1}{2}\right) = \frac{\pi^{\frac{1}{2}}}{2^{2x-1}}\Gamma(2x)$, $\Gamma\left(\frac{p+1}{2}\right)\Gamma\left(\frac{p+2}{2}\right) = \frac{\pi^{\frac{1}{2}}}{2^p}\Gamma(p+1)$.
 (Arts. 903, 905.)
14. $Lt_{n=\infty} \frac{1 \cdot 2 \cdot 3 \dots n}{\sqrt{2n\pi n^n} e^{-n}} = 1$. (Art. 877.)
15. $\frac{\Gamma(n+1)}{\sqrt{2n\pi n^n} e^{-n}} = \sum_0^\infty \frac{A_{2p+1}}{2^p p!} \frac{1}{n^p}$. (Art. 884.)
16. $\gamma = 0.57721566\dots = Lt_{n=\infty} \left(\frac{1}{1} + \frac{1}{2} + \dots + \frac{1}{n} - \log n\right)$.
 (Arts. 897, 917.)
17. $\int_x^{x+n} \log \Gamma(x) dx = \log \left[\frac{x^x(x+1)^{x+1}\dots(x+n-1)^{x+n-1}(2\pi)^{\frac{n}{2}}}{e^{nx + \frac{(n-1)n}{2}}} \right]$.
 (Art. 910.)

$$18. \frac{d}{dx} \log \Gamma(x) = Lt_{n=\infty} \left[\log n - \frac{1}{x} - \frac{1}{x+1} - \frac{1}{x+2} - \dots - \frac{1}{x+n-1} \right]$$

$$= -\gamma + \left(\frac{1}{1} - \frac{1}{x} \right) + \left(\frac{1}{2} - \frac{1}{x+1} \right) + \dots \text{ ad inf.} \quad (\text{Art. 911 (5).})$$

$$19. \frac{d^2}{dx^2} \log \Gamma(x) = \frac{1}{x^2} + \frac{1}{(x+1)^2} + \frac{1}{(x+2)^2} + \dots \text{ ad inf.} \quad (\text{Art. 911 (1).})$$

$$20. Lt_{n=\infty} \left(\frac{\Gamma'(n)}{\Gamma(n)} - \log n \right) = 0. \quad (\text{Art. 911 (3).})$$

$$21. \log \Gamma(1+x) = -\gamma x + S_2 \frac{x^2}{2} - S_3 \frac{x^3}{3} + S_4 \frac{x^4}{4} - \dots \quad (\text{Arts. 911, 916.})$$

$$22. \log \Gamma(1+x) = \frac{1}{2} \log \frac{x\pi}{\sin x\pi} - \tanh^{-1} x + (1-\gamma)x$$

$$- (S_3-1) \frac{x^3}{3} - (S_5-1) \frac{x^5}{5} - \dots \quad (\text{Art. 919.})$$

23. Min. ordinate of $y = \Gamma(x)$ is at $x = 1.4616\dots$ (Art. 922).

$$24. \log \Gamma(x) = \int_0^\infty \left[(x-1)e^{-\beta} - \frac{e^{-\beta} - e^{-x\beta}}{1 - e^{-\beta}} \right] \frac{d\beta}{\beta}. \quad (\text{Art. 930 (6).})$$

$$25. \frac{d}{dx} \log \Gamma(x) = \int_0^\infty \left(\frac{e^{-\beta}}{\beta} - \frac{e^{-x\beta}}{1 - e^{-\beta}} \right) d\beta; \quad (\text{Art. 925.})$$

$$\text{also} = \int_0^\infty \left\{ e^{-\beta} - \frac{1}{(1+\beta)^x} \right\} \frac{d\beta}{\beta}. \quad (\text{Art. 930 (3).})$$

$$26. \frac{d^n}{dx^n} \log \Gamma(x) = (-1)^n \int_0^\infty \frac{\beta^{n-1} e^{-x\beta}}{1 - e^{-\beta}} d\beta \quad (n \neq 2). \quad (\text{Art. 930 (9).})$$

$$27. S_p = \frac{1}{1^p} + \frac{1}{2^p} + \frac{1}{3^p} + \dots = \frac{1}{2\Gamma(p)} \int_0^\infty \frac{\beta^{p-1} e^{-\frac{\beta}{2}}}{\sinh \frac{\beta}{2}} d\beta,$$

$$s_p = \frac{1}{1^p} + \frac{1}{3^p} + \frac{1}{5^p} + \dots = \frac{1}{2\Gamma(p)} \int_0^\infty \frac{\beta^{p-1}}{\sinh \beta} d\beta.$$

$$s'_p = \frac{1}{1^p} - \frac{1}{3^p} + \frac{1}{5^p} - \dots = \frac{1}{2\Gamma(p)} \int_0^\infty \frac{\beta^{p-1}}{\cosh \beta} d\beta. \quad (\text{Arts. 928, 929.})$$

$$28. B_{2n-1} = \frac{2n}{(2^{2n}-1)\pi^{2n}} \int_0^\infty \frac{\beta^{2n-1}}{\sinh \beta} d\beta = 2n \int_0^\infty \frac{\beta^{2n-1} e^{-\pi\beta}}{\sinh \pi\beta} d\beta,$$

$$E_{2n} = \left(\frac{2}{\pi} \right)^{2n+1} \int_0^\infty \frac{\beta^{2n}}{\cosh \beta} d\beta. \quad (\text{Art. 929.})$$

$$29. \Sigma u_x = C + \int u_x dx - \frac{1}{2} u_x + \frac{B_1}{2!} \frac{du_x}{dx} - \frac{B_3}{4!} \frac{d^3 u_x}{dx^3} + \frac{B_5}{6!} \frac{d^5 u_x}{dx^5} - \dots$$

(Art. 931.)

$$30. \frac{d}{dx} \log \Gamma(x+1) = \log x + \frac{1}{2x} - \frac{B_1}{2x^2} + \frac{B_3}{4x^4} - \dots$$

$$- (-1)^{n-1} \frac{B_{2n-1}}{2n} \frac{1}{x^{2n}} - (-1)^n \frac{B_{2n+1}}{(2n+2)} \frac{1}{x^{2n+2}} \Theta \quad (0 < \Theta < 1).$$

(Art. 940.)

$$31. \log \Gamma(x+1) = \frac{1}{2} \log 2\pi + (x + \frac{1}{2}) \log x - x + \frac{B_1}{1} \frac{1}{2x} - \frac{B_3}{3} \frac{1}{4x^3} + \dots$$

$$+ (-1)^{n-1} \frac{B_{2n-1}}{(2n-1)2n} \frac{1}{x^{2n-1}} + (-1)^n \frac{B_{2n+1}}{(2n+1)(2n+2)} \frac{1}{x^{2n+1}} \Theta$$

(0 < \Theta < 1). (Art. 940.)

$$32. \frac{\Gamma(x+1)}{\sqrt{2\pi x} x^x e^{-x}} = 1 + \frac{1}{12x} + \frac{1}{2(12x)^2} - \frac{139}{30(12x)^3} - \frac{571}{120(12x)^4} + \dots$$

See also No. 15. (Art. 942.)

956. II. GROUP OF ψ FORMULAE.

Since the ψ -function, viz. $\psi(x) = \frac{d}{dx} \log \Gamma(x)$, is a very interesting function, and very useful in itself, we gather together the principal results which refer to this function in particular.

$$1. \psi(x) = \frac{\Gamma'(x)}{\Gamma(x)} = Lt_{n \rightarrow \infty} \left[\log n - \frac{1}{x} - \frac{1}{x+1} - \dots - \frac{1}{x+n-1} \right].$$

(Art. 911.)

$$2. \psi(0) = -\infty, \quad \psi(1) = -\gamma, \quad \psi(1.4616\dots) = 0, \quad \psi(\infty) = \infty.$$

(Arts. 911 (3), 922, 923.)

$$3. \psi(x) - \psi(1) = \left(\frac{1}{1} - \frac{1}{x} \right) + \left(\frac{1}{2} - \frac{1}{x+1} \right) + \left(\frac{1}{3} - \frac{1}{x+2} \right) + \dots$$

(Art. 911.)

$$4. \psi'(x) = \frac{1}{x^2} + \frac{1}{(x+1)^2} + \frac{1}{(x+2)^2} + \dots$$

(Art. 911.)

$$5. \psi(x) = \int_0^{\infty} \left(\frac{e^{-\beta}}{\beta} - \frac{e^{-x\beta}}{1-e^{-\beta}} \right) d\beta = \int_0^{\infty} \left\{ e^{-\beta} - \frac{1}{(1+\beta)^x} \right\} \frac{d\beta}{\beta}.$$

(Arts. 925, 930 (3) and (7).)

$$6. \psi'(x) = \int_0^\infty \frac{\beta e^{-\beta}}{1 - e^{-\beta}} d\beta. \quad (\text{Art. 930 (8).})$$

$$7. \psi(x+1) = \log x + \frac{1}{2x} - \frac{B_1}{2x^2} + \frac{B_3}{4x^4} - \dots \quad (\text{Art. 940.})$$

$$8. \psi'(x+1) = \frac{1}{x} - \frac{1}{2x^2} + \frac{B_1}{x^3} - \frac{B_3}{x^5} + \dots \quad (\text{Art. 940.})$$

$$9. \psi(x) + \gamma = \int_0^\infty \frac{e^{-\beta} - e^{-x\beta}}{1 - e^{-\beta}} d\beta. \quad (\text{Art. 944.})$$

$$10. \psi(x) + \gamma = \int_0^1 \frac{1 - t^{x-1}}{1 - t} dt \quad (x \text{ integral}). \quad (\text{Art. 944.})$$

$$11. \psi(1+a) - \psi(1+b) = \int_0^1 \frac{t^b - t^a}{1 - t} dt. \quad (\text{From 10.})$$

$$12. \Delta\psi(a+x) = \frac{1}{a+x}. \quad (\text{Art. 950.})$$

$$13. \psi(x+1) - \psi(x) = \frac{1}{x}. \quad (\text{Art. 952.})$$

$$14. \psi(1-x) - \psi(x) = \pi \cot x\pi. \quad (\text{Art. 952.})$$

$$15. \psi\left(\frac{1}{2} + x\right) - \psi\left(\frac{1}{2} - x\right) = \pi \tan x\pi. \quad (\text{From 14.})$$

$$16. \psi(x) + \psi\left(\frac{1}{2} + x\right) = 2\psi(2x) - 2 \log 2. \quad (\text{Art. 952.})$$

$$17. \psi(x) - \frac{1}{2}\psi\left(\frac{1-x}{2}\right) = \frac{1}{2}\psi\left(\frac{x}{2}\right) + \log 2 + \frac{\pi}{2} \tan \frac{x\pi}{2}. \quad (\text{Art. 952.})$$

$$18. \psi(x) + \psi\left(x + \frac{1}{n}\right) + \psi\left(x + \frac{2}{n}\right) + \dots + \psi\left(x + \frac{n-1}{n}\right) \\ = n\psi(nx) - n \log n. \quad (\text{Art. 952.})$$

$$19. \psi(a+x) = \psi(a) + \frac{x}{a} - \frac{1}{2} \frac{x(x-1)}{a(a+1)} + \frac{1}{3} \frac{x(x-1)(x-2)}{a(a+1)(a+2)} - \text{etc.} \\ (\text{Art. 950.})$$

$$20. \psi\left(1 - \frac{p}{q}\right) + \psi\left(\frac{p}{q}\right) \\ = 2 \left[\psi(1) - \log q + \sum_1^{\frac{q-1}{2}} \cos \frac{2rp\pi}{q} \log 4 \sin^2 \frac{r\pi}{q} \right] \quad (q \text{ odd}) \\ (\text{Art. 953.}) \\ = 2 \left[\psi(1) - \log q + \sum_1^{\frac{q-2}{2}} \cos \frac{2rp\pi}{q} \log 4 \sin^2 \frac{r\pi}{q} \right] + (-1)^p 2 \log 2 \\ (q \text{ even}).$$

957. Table of Values of $S_p = \frac{1}{1^p} + \frac{1}{2^p} + \frac{1}{3^p} + \frac{1}{4^p} + \dots$ *ad inf.*
 up to $p=35$, which is the last in which the tenth decimal place is affected; all remaining ones to this approximation may be regarded as = 1. (De Morgan, *D.C.*, p. 554.)

p	S_p to sixteen places of decimals.
1	0.57721 56649 01532 9... + log ∞ (Euler's Const. + ∞)
2	1.64493 40668 48226 4
3	1.20205 69031 59594 3
4	1.08232 32337 11138 2
5	1.03692 77551 43370 0
6	1.01734 30619 84449 1
7	1.00834 92773 81922 7
8	1.00407 73561 97944 3
9	1.00200 83928 26082 2
10	1.00099 45751 27818 0
11	1.00049 41886 04119 4
12	1.00024 60865 53308 0
13	1.00012 27133 47578 5
14	1.00006 12481 35058 7
15	1.00003 05882 36307 0
16	1.00001 52822 59408 6
17	1.00000 76371 97637 9
18	1.00000 38172 93265 0
19	1.00000 19082 12716 6
20	1.00000 09539 62033 9
21	1.00000 04769 32986 8
22	1.00000 02384 50502 7
23	1.00000 01192 19926 0
24	1.00000 00596 08189 1
25	1.00000 00298 03503 5
26	1.00000 00149 01554 8
27	1.00000 00074 50711 8
28	1.00000 00037 25334 0
29	1.00000 00018 62659 7
30	1.00000 00009 31327 4
31	1.00000 00004 65662 9
32	1.00000 00002 32831 2
33	1.00000 00001 16415 5
34	1.00000 00000 58207 7
35	1.00000 00000 29103 8

The sixteenth decimal place is not always the sixteenth occurring,
 but the nearest in consideration of terms to follow, e.g. γ has for its
 16th, 17th, etc., ... figures 8606....
 $\log_e 10 = 2.30258 50929 94045 6840 \dots$
 Euler's Const. = $\gamma = 0.57721 56649 01532 8606 \dots$
 $\mu = 0.43429 44819 \dots$

PROBLEMS.

- Show that (i) $\Gamma(\frac{1}{3}) \Gamma(\frac{2}{3}) = \frac{2\pi}{\sqrt{3}}$; (ii) $\Gamma(\frac{1}{3}) \Gamma(\frac{5}{6}) = \pi^{\frac{1}{2}} 2^{\frac{1}{3}} \Gamma(\frac{2}{3})$.
- Show that $3^{\frac{1}{2}} \{\Gamma(\frac{1}{3})\}^2 = \pi^{\frac{1}{2}} 2^{\frac{1}{3}} \Gamma(\frac{1}{6})$.
- Show that $\Gamma(1) \Gamma(2) \Gamma(3) \dots \Gamma(9) = \frac{(2\pi)^{\frac{9}{2}}}{\sqrt{10}}$.

4. Show that $2^n \Gamma(n + \frac{1}{2}) = 1 \cdot 3 \cdot 5 \dots (2n - 1) \sqrt{\pi}$, where n is a positive integer. [OXFORD II. P., 1888.]

5. Show that $\Gamma(\frac{3}{2} - x) \Gamma(\frac{3}{2} + x) = (\frac{1}{4} - x^2) \pi \sec \pi x$, provided $-1 < 2x < 1$.

6. Show by means of the transformation $xy = u, y = u + v$, that

$$\int_0^1 \int_0^1 \frac{(1-x)^{m-1} y^m (1-y)^{n-1}}{(1-xy)^{m+n-1}} dx dy = B(m, n).$$

[COLL. γ , 1901.]

7. By means of the integral $\int_0^1 x^{m-1} (1-x^a)^n dx$, prove that

$$\frac{1}{(m) n!} - \frac{1}{(m+a)(n-1)!} + \frac{1}{(m+2a)(n-2)!} - \dots + \frac{(-1)^n}{(m+na) n!} \\ = \frac{a^n}{m(m+a)(m+2a) \dots (m+na)}.$$

[ST. JOHN'S, 1884.]

Show that this integral may be expressed as $\frac{n! \Gamma(\frac{m}{a})}{a \Gamma(\frac{m}{a} + n + 1)}$.

8. Show that the product of the series

$$1 + \frac{1}{2} \cdot \frac{1}{17} + \frac{1 \cdot 3}{2 \cdot 4} \cdot \frac{1}{33} + \frac{1 \cdot 3 \cdot 5}{2 \cdot 4 \cdot 6} \cdot \frac{1}{49} + \text{etc.}$$

and $1 + \frac{1}{2} \cdot \frac{1}{25} + \frac{1 \cdot 3}{2 \cdot 4} \cdot \frac{1}{41} + \frac{1 \cdot 3 \cdot 5}{2 \cdot 4 \cdot 6} \cdot \frac{1}{57} + \text{etc.}$ is $\frac{\pi}{16}$.

[COLLEGES α , 1883.]

9. Prove by the substitution $x^2 = \xi$ that

$$\int_0^\infty e^{-x^2} x^{2n} dx = \sqrt{\pi} \frac{1 \cdot 3 \cdot 5 \dots (2n-1)}{2 \cdot 4 \cdot 6 \dots 2n} \int_0^\infty e^{-x^2} x^{2n+1} dx,$$

where n is a positive integer.

[See also Art. 223 (5).]

[COLLEGES α , 1890.]

10. Show that if K be any positive constant,

$$\int_0^K \int_0^{K-x} e^{-x-y} x^{l-1} y^{m-1} dx dy = \int_0^1 (1-v)^{l-1} v^{m-1} dv \cdot \int_0^K e^{-u} u^{l+m-1} du,$$

and by proceeding to a limit express $B(l, m)$ in terms of Gamma functions. [OXF. II. P., 1902.]

11. Show that the sum of the series

$$\frac{1}{n+1} + m \frac{1}{n+2} + \frac{m(m+1)}{2!} \frac{1}{n+3} + \frac{m(m+1)(m+2)}{3!} \frac{1}{n+4} + \dots$$

is $\Gamma(n+1) \Gamma(1-m) / \Gamma(n-m+2)$,

where $n > -1$, and $m < 1$.

[COLL. γ , 1899.]

12. From the value in Gamma functions of $\int_0^{\frac{\pi}{2}} \sin^p \theta \cos^q \theta d\theta$, show that

$$2^p \Gamma\left(\frac{p+1}{2}\right) \Gamma\left(\frac{p+2}{2}\right) = \sqrt{\pi} \Gamma(p+1)$$

for all real values of p .

[TRINITY, 1886.]

13. Prove that $\int_5^{\infty} e^{-x^2} dx = e^{-25} \times 0.09811$ nearly. [TRINITY, 1896.]

14. Prove that

$$\Gamma(n) = \frac{1}{n} \frac{\left(1 + \frac{1}{1}\right)^n}{\left(1 + \frac{1}{1}\right)} \cdot \frac{\left(1 + \frac{1}{2}\right)^n}{\left(1 + \frac{1}{2}\right)} \cdot \frac{\left(1 + \frac{1}{3}\right)^n}{\left(1 + \frac{1}{3}\right)} \dots \text{to } \infty$$

and $\Gamma(n+1) = \prod_{r=1}^{r=n} \frac{\left(1 + \frac{1}{r}\right)^n}{\left(1 + \frac{n}{r}\right)}$.

[OXFORD II. P., 1903.]

15. Show that, when x is positive,

$$2^{2x-1} B(x, x) = \sqrt{\pi} \frac{\Gamma(x)}{\Gamma\left(x + \frac{1}{2}\right)} = \sum_{n=0}^{\infty} \frac{2n!}{2^{2n} n! n!} \frac{1}{x+n}.$$

[MATH. TRIP., 1897.]

16. Prove that, if x be positive,

$$x \left(\frac{1+x}{2}\right)^{\frac{1}{2}} \left(\frac{2+x}{3}\right)^{\frac{1}{3}} \left(\frac{3+x}{4}\right)^{\frac{1}{4}} \dots \text{to } \infty = e^{\sqrt{\pi} \int_1^x \frac{\Gamma(x)}{\Gamma(x+1)} dx}.$$

[MATH. TRIPOS, 1897.]

17. Show that, when x is a real positive quantity not greater than unity,

$$e \Gamma(x) = f(x) + \sum_{n=0}^{\infty} \frac{1}{x(x+1)(x+2)\dots(x+n)}$$

where $f(x)$ is a function of x not greater than unity.

[MATH. TRIPOS, 1897.]

18. If n lie between zero and unity, prove that

$$\int_0^{\frac{\pi}{2}} (\tan x)^n dx = \frac{1}{2} \frac{\pi}{\sin \frac{n+1}{2} \pi}.$$

[COLL. a, 1890.]

19. Show that the perimeter of a loop of the curve $r^n = a^n \cos n\theta$ is

$$\frac{a}{n} 2^{\frac{1}{n}-1} \left(\Gamma \frac{1}{2n}\right)^2 / \left(\Gamma \frac{1}{n}\right).$$

20. Show that if x, y be a point on the ellipse $x^2/a^2 + y^2/b^2 = 1$, and $2r$ be the conjugate diameter, and the integral be taken round the whole perimeter, then

$$\int \frac{x^l y^l}{r^{2l+2}} ds = \frac{2 \left\{ \Gamma\left(\frac{l+1}{2}\right) \right\}^2}{\Gamma(l+1)} \cdot \frac{1}{ab}. \quad [\text{COLLEGES, 1892.}]$$

21. Express in Gamma functions

$$\int_0^1 (1-x^n)^{\frac{1}{n}} dx. \quad [\text{TRINITY, 1896.}]$$

22. Express in Gamma functions the area of the curve $yc^x = ax^c$ ($c > 0$) for positive values of x (0 to ∞), also the volume generated by its revolution round the axis of x . [ST. JOHN'S, 1883.]

23. If $2 \sin n\pi \Gamma(n) \phi(n) = (2\pi)^n \phi(1-n) \{(-\iota)^{n-1} + \iota^{n-1}\}$ where $\iota = \sqrt{-1}$ and $\phi(n)$ is some function of n , prove that

$$\Gamma\left(\frac{n}{2}\right) \pi^{-\frac{n}{2}} \phi(n)$$

remains unaltered when $1-n$ is written for n . [COLLEGES a, 1881.]

24. Prove that

$$\int_a^\infty e^{-at} dt = \frac{e^{-ax}}{2a} \left[\frac{1}{1+} \frac{q}{1+} \frac{2q}{1+} \frac{3q}{1+} \frac{4q}{1+} \text{ etc.} \right], \quad \text{where } q = \frac{1}{2a^2}.$$

[DE MORGAN, *Diff. Cal.*, p. 591.]

25. Prove that

$$\int_v^\infty e^{-v} \log v dv = e^{-v} \left[\log v + \frac{v^{-1}}{1+} \frac{v^{-1}}{1+} \frac{v^{-1}}{1+} \frac{2v^{-1}}{1+} \frac{2v^{-1}}{1+} \frac{3v^{-1}}{1+} \frac{3v^{-1}}{1+} \text{ etc.} \right].$$

[DE MORGAN, p. 591.]

26. Prove that

$$\frac{d}{dx} \log \Gamma(1+x) = -\gamma + x - \frac{1}{2} \frac{x(x-1)}{1 \cdot 2} + \frac{1}{3} \frac{x(x-1)(x-2)}{1 \cdot 2 \cdot 3} - \dots$$

[DE MORGAN, p. 593.]

27. If $\phi(x) = \frac{d}{dx} \log \Gamma(1+x)$ and x be a positive integer, show that

$$\phi(x) = \phi(0) + 1 + \frac{1}{2} + \frac{1}{3} + \dots + \frac{1}{x}.$$

Prove further that

$$\phi(0) = \int_0^\infty e^{-x} \log x dx,$$

and has a finite value.

[I. C. S., 1898.]

28. If $(1+x)^n = 1 + A_1x + A_2x^2 + \dots$, where n is any positive quantity, prove that

$$1 + A_1^2 + A_2^2 + \dots = \frac{2^{2n} \Gamma(n + \frac{1}{2})}{\sqrt{\pi} \Gamma(n + 1)}.$$

[MATH. TRIPOS, 1895.]

29. Prove that if

$$f(x) = f(0) + xf'(0) + \frac{x^2}{2!}f''(0) + \dots + \frac{x^n}{n!}f^n(\theta x),$$

$$\int_0^\infty \frac{f^n(\theta x)}{x^r} dx = \frac{\Gamma(n+1)\Gamma(r)}{\Gamma(n+r)} \int_0^\infty \frac{f^n(x)}{x^r} dx,$$

r being any positive quantity.

[If $r > 1$ both integrals generally = ∞ .]

[WOLSTENHOLME, *Educ. Times*.]

30. Prove by changing the order of integration or otherwise that

$$\int_0^x \frac{dy}{\sqrt{x-y}} \int_0^y \frac{f'(\xi) d\xi}{\sqrt{y-\xi}} = \pi \{f(x) - f(0)\}.$$

[MATH. TRIPOS, 1875.]

31. Show that

$$\int \frac{dx}{1+x^n} = \frac{x}{1+x} + \frac{n+1}{1+x} \frac{x^n}{(n+1)(2n+1)} + \frac{(n+1)^2 x^n}{1+x} \frac{(2n+1)(3n+1)}{(3n+1)(4n+1)} + \frac{(2n)^2 x^n}{1+x} \frac{(2n+1)^2 x^n}{(4n+1)(5n+1)} + \dots$$

[LACROIX, *Calc. Diff.*, vol. ii., p. 292.]

Deduce expressions for $\log 1+x$ and $\tan^{-1}x$ as continued fractions.

32. Prove that

$$\prod_1^\infty \left(1 + \frac{x^2}{n^2}\right) = x^{-3} / \Gamma(x) \Gamma(x\omega) \Gamma(x\omega^2), \text{ where } \omega = e^{\frac{2i\pi}{3}}.$$

[ST. JOHN'S, 1891.]

33. Evaluate the modulus of $\Gamma(\frac{1}{2} + \sqrt{-1}a)$. [SMITH'S PRIZE, 1875.]

34. Show that for very large integral values of n , $\Gamma(n + \frac{1}{2})$ is very nearly the geometric mean between $\Gamma(n)$ and $\Gamma(n+1)$.

[OXFORD, 1892.]

35. If b be a large whole number, show that, provided $x > -1$,

$$(x+1)(x+2) \dots (x+b) = b^x \frac{\Gamma(b+1)}{\Gamma(x+1)}, \text{ very nearly.}$$

[DE MORGAN, *Diff. Calc.*, p. 585.]

36. Writing $\phi(x) \equiv e^x \cdot x! / \sqrt{2\pi} x^{x+\frac{1}{2}}$, prove by the aid of Wallis' theorem that $\phi(2x) = [\phi(x)]^2$ when x is large.

Then show that for any value of x ,

(a) $\frac{\phi(x)}{\phi(x+1)} = e^{-1+(x+\frac{1}{2})\log(1+\frac{1}{x})}$.

(b) $\log \frac{\phi(x)}{\phi(x+1)} = \frac{1}{12x^2} - \frac{1}{12x^3} + \frac{3}{40x^4} - \dots + \frac{(n-1)}{2n(n+1)} \frac{(-1)^n}{x^n} + \dots$

(c) $\frac{\phi(x)}{\phi(x+1)} < e^{\frac{1}{12x^2}}$. (d) $\log \frac{\phi(x)}{\phi(x+1)} < \frac{1}{12x(x+1)}$.

(e) $\frac{\phi(x)}{\phi(2x)} = \frac{\theta_0}{x^2} + \frac{\theta_1}{(x+1)^2} + \frac{\theta_2}{(x+2)^2} + \dots + \frac{\theta_{x-1}}{(2x-1)^2}$,

where $\theta_0, \theta_1, \theta_2, \dots$ are numbers between 0 and $\frac{1}{12}$.

(f) $\frac{\phi(x)}{\phi(2x)} = e^\theta$ ($0 < \theta < \frac{1}{12}$),

and finally deduce Stirling's theorem,

$$1 \cdot 2 \cdot 3 \dots x = \sqrt{2\pi} e^{-x} x^{x+\frac{1}{2}} (1 + \epsilon_x),$$

where ϵ_x denotes a positive quantity which vanishes when $x = \infty$.

[SERRET, *Calc. Intég.*, p. 207.]

37. Show that, if x be a whole number,

$$\log \Gamma(x+1) = \frac{1}{2} \log 2\pi - x + (x + \frac{1}{2}) \log x + \sum_{m=0}^{m=\infty} \left[\left(x + m + \frac{1}{2}\right) \log \left(1 + \frac{1}{x+m}\right) - 1 \right].$$

[GUDERMANN.]

38. Show that

$$1 \cdot 2 \cdot 3 \dots x > \sqrt{2\pi x} x^x e^{-x} \quad \text{and} \quad < \sqrt{2\pi x} x^x e^{-x + \frac{1}{12x}}$$

when x is large.

[SERRET, *Calc. Intég.*, p. 213.]

39. Writing

$$\phi(x) = Lt_{m=\infty} \frac{(m!)^n n^{mn+1}}{(mn)! m^{\frac{n-1}{2}}}, \quad \psi(m) = \frac{m!}{m^{m+\frac{1}{2}}}, \quad \text{and} \quad u_n = \sqrt{n} Lt \frac{[\psi(m)]^n}{\psi(mn)},$$

prove that

$$u_n = u_2^{n-1}, \quad u_2 = \frac{\phi(2)}{\sqrt{2}} = \sqrt{2\pi}, \quad \phi(n) = n^{\frac{1}{2}} (2\pi)^{\frac{n-1}{2}}.$$

Hence deduce Gauss' theorem,

$$n^{nx} \Gamma(x) \Gamma\left(x + \frac{1}{n}\right) \dots \Gamma\left(x + \frac{n-1}{n}\right) = (2\pi)^{\frac{n-1}{2}} n^{\frac{1}{2}} \Gamma(nx).$$

[SERRET, *Calc. Intégral*, p. 190.]

40. Prove that

$$\sum_{r=0}^{\infty} \left\{ \frac{1}{(x+r)^n} - \frac{1}{r^n} \right\} = \frac{(-1)^n}{\Gamma(n)} \int_0^1 \frac{1-v^x}{1-v} (\log v)^{n-1} dv.$$

[Cf. DE MORGAN, *Diff. C.*, p. 594.]

41. Prove that

$$\frac{d}{dx} \log \Gamma(x) = \log x + \int_0^{\infty} \left\{ e^{-xt} - (1+t)^{-x} \right\} \frac{dt}{t},$$

and that

$$\frac{1}{\Gamma(x+1)} = e^{Cx} \prod_{n=1}^{\infty} \left[\left(1 + \frac{x}{n} \right) e^{-\frac{x}{n}} \right],$$

where C is a certain constant.

[MATH. TRIPOS, Pt. II., 1915.]

42. If the binomial expansion for a positive index be written

$$(a+b)^n = \sum \binom{n}{r} a^r b^{n-r},$$

show that

$$\sum \binom{n}{r} B(n-r+1, r+1) = 1.$$

Prove also that

$$\frac{2\pi}{3\sqrt{3}} = 1 + \frac{(1!)^2}{3!} + \frac{(2!)^2}{5!} + \frac{(3!)^2}{7!} + \frac{(4!)^2}{9!} + \dots$$

43. Show that $(1000)!$ lies between

$$4 \cdot 02387 \times 10^{2567} \quad \text{and} \quad 4 \cdot 02388 \times 10^{2567},$$

and is a number with 2568 figures in the ordinary system of numeration, its logarithm being $2567 \cdot 6046442\dots$

[COURNOT, *Théorie des Fonctions*, vol. II., p. 472.]

44. Show that if

$$\begin{aligned} \log \Gamma(x+1) = & \log \sqrt{2\pi} + (x + \frac{1}{2}) \log x - x + \frac{B_1}{1 \cdot 2x} - \frac{B_3}{3 \cdot 4x^3} + \dots \\ & + (-1)^{n-1} \frac{B_{2n-1}}{(2n-1)(2n)x^{2n-1}} + (-1)^n \frac{R}{(2n+2)!}, \end{aligned}$$

then

$$R = \int_0^{\infty} e^{-ax} a^{2n} f^{2n+2}(\theta a) da,$$

where $f(a) \equiv \frac{a}{e^a - 1}$ and θ is a positive proper fraction.

[LIOUVILLE, *Journal de Mathématiques*, Tom. iv., p. 317.]

If λ_{2n+2} be the maximum numerical value of $f^{2n+2}(a)$ between the limits $a=0$, $a=\infty$, show that

$$\frac{R}{(2n+2)!} < \frac{\lambda_{2n+2}}{(2n+1)(2n+2)} \frac{1}{x^{2n+1}},$$

and examine the nature of the approximation attained by the omission of all the terms which contain Bernoulli's coefficients.

[LIOUVILLE, *J. de M.*; also COURNOT, *Théorie des Fonctions*, p. 474.]

45. Starting with

$$\begin{aligned} \log \Gamma(x) &= \int_0^\infty \left[(x-1)e^{-\beta} - \frac{e^{-\beta} - e^{-x\beta}}{1 - e^{-\beta}} \right] d\beta \\ &= \int_0^\infty (P + Qe^{-x\beta}) d\beta, \text{ say,} \end{aligned}$$

and putting R for the two terms with negative indices in the development of Q in ascending powers of β , namely $\frac{1}{\beta^2} + \frac{1}{2\beta}$, let

$$F(x) = \int_0^\infty (P + Re^{-x\beta}) d\beta \quad \text{and} \quad \varpi(x) = \int_0^\infty (Q - R)e^{-x\beta} d\beta.$$

Then show that

- (1) $\varpi(\frac{1}{2}) = \frac{1}{2} \log \frac{e}{2}$. (2) $F(\frac{1}{2}) = \frac{1}{2} \log \frac{2\pi}{e}$.
 (3) $F(x) - F(\frac{1}{2}) = \frac{1}{2} - x + (x - \frac{1}{2}) \log x$. (4) $\Gamma(x) = e^{-x} x^{x-1} \sqrt{2\pi} e^{\varpi(x)}$.
 (5) That when x is large $e^{\varpi(x)}$ differs but little from unity.
 (6) $\log \Gamma(x+1) = \frac{1}{2} \log 2\pi + (x + \frac{1}{2}) \log x - x$

$$+ \int_0^\infty \left(\frac{1}{1 - e^{-\beta}} - \frac{1}{\beta} - \frac{1}{2} \right) e^{-\beta x} \frac{d\beta}{\beta}, \quad \text{and}$$

(7) Deduce the equation,

$$\begin{aligned} \log \Gamma(x+1) &= \frac{1}{2} \log(2\pi) + (x + \frac{1}{2}) \log x - x + \frac{B_1}{1 \cdot 2} \frac{1}{x} - \frac{B_3}{3 \cdot 4} \frac{1}{x^3} + \dots \\ &+ (-1)^{n-1} \frac{B_{2n-1}}{(2n-1) 2n} \frac{1}{x^{2n-1}} + (-1)^n \frac{B_{2n+1}}{(2n+1)(2n+2)} \frac{1}{x^{2n+1}} \Theta, \\ &0 < \Theta < 1. \quad [\text{BERTRAND, } \textit{Calc. Integral}, \text{ p. 265.}] \end{aligned}$$

46. Show that

$$(1) \quad \gamma = \int_0^\infty \left(\frac{1}{1 - e^{-\beta}} - \frac{1}{\beta} \right) e^{-\beta} d\beta.$$

$$(2) \quad \log \Gamma(x+1) = \int_0^\infty \frac{e^{-\beta}}{\beta} \left\{ x - \frac{1 - e^{-\beta x}}{1 - e^{-\beta}} \right\} d\beta.$$

[TODHUNTER, *Int. Calc.*, p. 392.]

47. If A_r be the acute angle whose tangent is the n^{th} power of the reciprocal of the r^{th} of the prime numbers 2, 3, 5, ..., show that

$$\cos 2A_1 \cos 2A_2 \cos 2A_3 \cos 2A_4 \dots \text{ to } \infty = 2 \frac{B_{2n}}{B_n^2} \frac{\{(2n)!\}^2}{(4n)!},$$

where B_n is the n^{th} number of Bernoulli. [MATH. TRIPOS, 1897]

48. If $I = \int_0^1 \frac{dx}{\sqrt{1-x^3}}$, show that

$$\begin{aligned} \Gamma\left(\frac{1}{8}\right) &= \pi^{\frac{1}{2}} 2^{\frac{1}{2}} 3^{\frac{1}{2}} I^{\frac{1}{2}}, & \Gamma\left(\frac{1}{3}\right) &= \pi^{\frac{1}{2}} 2^{\frac{1}{2}} 3^{\frac{1}{2}} I^{\frac{1}{2}}, \\ \Gamma\left(\frac{2}{3}\right) &= \pi^{\frac{1}{2}} 2^{\frac{1}{2}} 3^{-\frac{1}{2}} I^{-\frac{1}{2}}, & \Gamma\left(\frac{5}{8}\right) &= \pi^{\frac{1}{2}} 2^{\frac{1}{2}} 3^{-\frac{1}{2}} I^{-\frac{1}{2}}. \end{aligned}$$

49. If $I = \int_0^1 \frac{dx}{\sqrt{1-x^5}}$ and $J = \int_0^1 \frac{x dx}{\sqrt{1-x^5}}$, show that

$$\begin{aligned} \Gamma(\frac{1}{10}) &= \pi^{1/5} 2^{1/5} 5^{1/5} S_1^{-1/5} S_4^{1/5} I^{1/2} J^{1/2}, & \Gamma(\frac{2}{10}) &= \pi^{1/5} 2^{2/5} 5^{1/5} S_1^{-1/5} S_4^{-1/5} I^{1/2} J^{1/2}, \\ \Gamma(\frac{3}{10}) &= \pi^{1/5} 2^{-2/5} 5^{1/5} S_1^{1/5} S_3^{-1} S_4^{1/5} I^{1/2} J^{-1/2}, & \Gamma(\frac{4}{10}) &= \pi^{1/5} 2^{-1/5} 5^{1/5} S_1^{-1/5} S_4^{-1/5} I^{-1/2} J^{1/2}, \end{aligned}$$

where $S_1 = \sin \frac{\pi}{10}$, $S_2 = \sin \frac{2\pi}{10}$, $S_3 = \sin \frac{3\pi}{10}$, $S_4 = \sin \frac{4\pi}{10}$,

and write down the values of $\Gamma(\frac{6}{10})$, $\Gamma(\frac{7}{10})$, $\Gamma(\frac{8}{10})$, $\Gamma(\frac{9}{10})$, in similar form.

50. Show that $\int_0^\infty x^2 [\log(1+e^x) - x] dx = \frac{7\pi^4}{360}$.

[OXFORD I. P., 1914.]

51. Prove that the volume in the positive octant bounded by the planes $x=0$, $y=0$, $z=h$ and the surface $z^m/c^m = x^m/a^m + y^m/b^m$ is equal to

$$abh \left(\frac{h}{c}\right)^m \frac{\left\{ \Gamma\left(\frac{1}{m}\right) \right\}^2}{2(m+2) \Gamma\left(\frac{2}{m}\right)}.$$

[MATH. TRIP., PART II., 1913.]

52. Prove that $e^{h \frac{d^2}{dx^2}} \{ \phi(x) \} = \frac{1}{\sqrt{\pi}} \int_{-\infty}^{\infty} e^{-y^2} \phi(x+2y\sqrt{h}) dy$,

and apply the result to prove that if $1+4hk$ be positive,

$$e^{h \frac{d^2}{dx^2}} \{ x e^{-kx^2} \} = \frac{x}{(1+4hk)^{1/2}} e^{-\frac{kx^2}{1+4hk}}.$$

[MATH. TRIP., 1870 (WOLSTENHOLME).]

53. When n is a positive integer, we have evidently

$$1 \cdot 2 \cdot 3 \dots 2n = 2^{2n} \cdot 1 \cdot 2 \dots n \cdot \frac{1}{2} \cdot \frac{3}{2} \dots (n - \frac{1}{2});$$

prove that this equation, when expressed by means of the function Γ , is true for any positive value of n . [SIR G. G. STOKES, S. P., 1870.]

54. Prove that the limiting value of

$$2n+1 - 2 \log \frac{(2n+1)^n}{1 \cdot 3 \cdot 5 \dots (2n-1)},$$

when n is indefinitely increased, is $\log 2$.

[R. P.]

CHAPTER XXV.

LEJEUNE-DIRICHLET INTEGRALS, LIOUVILLE INTEGRALS, ETC.

958. We have seen that the formula (i_1 and i_2 both +ve)

$$\int_0^1 x^{i_1-1} (1-x)^{i_2-1} dx = \frac{\Gamma(i_1)\Gamma(i_2)}{\Gamma(i_1+i_2)}$$

leads at once, by putting y for ax , to

$$\int_0^a x^{i_1-1} (a-x)^{i_2-1} dx = a^{i_1+i_2-1} \frac{\Gamma(i_1)\Gamma(i_2)}{\Gamma(i_1+i_2)}.$$

Now, consider the double integral

$$I = \iint x_1^{i_1-1} x_2^{i_2-1} dx_1 dx_2$$

for all positive values of x_1 and x_2 , which are such that their sum cannot be greater than unity.

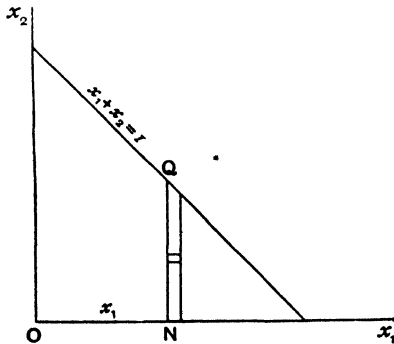

Fig. 321.

Then the limits for x_2 must be from 0 to $1-x_1$, x_1 remaining constant in the integration with regard to x_2 , and the limits for x_1 will be from 0 to 1.

The geometrical interpretation is that we are adding up all such products as $x_1^{i_1-1} x_2^{i_2-1} \delta x_1 \delta x_2$ as lie within the triangle formed by the axes Ox_1 , Ox_2 , and the straight line $x_1 + x_2 = 1$. We use this notation rather than the ordinary x - y notation for Cartesians, because we propose to generalise the theorem for any number of variables. The limits must then be such as to add up all elements in a strip NQ parallel to the x_2 -axis, *i.e.* x_2 increases from 0 to $1 - x_1$, and in summing the strips, x_1 increases from $x_1 = 0$ to $x_1 = 1$.

$$\begin{aligned} \text{Then } I &= \int_0^1 x_1^{i_1-1} \left[\frac{x_2^{i_2}}{i_2} \right]_0^{1-x_1} dx_1 = \frac{1}{i_2} \int_0^1 x_1^{i_1-1} (1-x_1)^{i_2} dx_1 \\ &= \frac{1}{i_2} \frac{\Gamma(i_1)\Gamma(i_2+1)}{\Gamma(i_1+i_2+1)} = \frac{\Gamma(i_1)\Gamma(i_2)}{\Gamma(i_1+i_2+1)}. \end{aligned}$$

959. Take next the case of the triple integral

$$I = \iiint x_1^{i_1-1} x_2^{i_2-1} x_3^{i_3-1} dx_1 dx_2 dx_3$$

for positive values of x_1 , x_2 , x_3 , such that $x_1 + x_2 + x_3 \leq 1$.

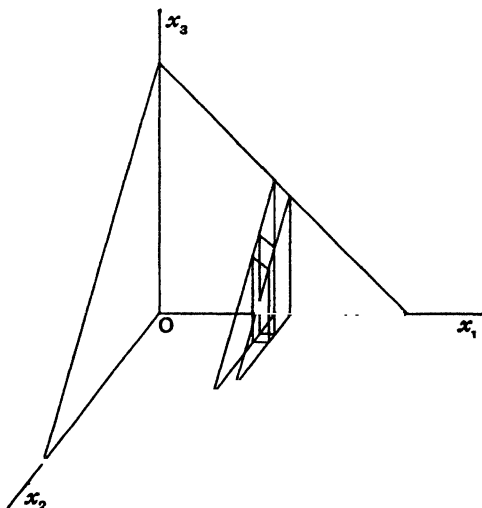

Fig. 322.

The geometrical interpretation is that we are to add up all elements such as $x_1^{i_1-1} x_2^{i_2-1} x_3^{i_3-1} \delta x_1 \delta x_2 \delta x_3$ which lie within the tetrahedron bounded by the coordinate planes x_1Ox_2 , x_2Ox_3 , x_3Ox_1 and the plane $x_1 + x_2 + x_3 = 1$.

Then dividing by planes parallel to the coordinate planes in the same way as explained in previous chapters, we have first to integrate with regard to x_3 , keeping x_1 and x_2 constant, that is, for all values of x_3 which lie between $x_3=0$ and $x_3=1-x_1-x_2$, which, interpreted geometrically, means the addition of all elements which lie in an elementary prism parallel to the x_3 -axis and whose ends lie respectively in the plane of $x_3=0$ and the plane $x_1+x_2+x_3=1$. Then, keeping x_1 constant, we have to integrate for all values of x_2 from $x_2=0$ to the value of x_2 which makes $1-x_1-x_2$ vanish; which means that we are to add up all the prisms which lie in a thin slice parallel to the plane of $x_1=0$. Finally, we are to integrate from $x_1=0$ to $x_1=1$, which means that we are to add up all the slices within the tetrahedron.

$$\begin{aligned} \text{Then } I &= \int_0^1 \int_0^{1-x_1} \int_0^{1-x_1-x_2} x_1^{i_1-1} x_2^{i_2-1} x_3^{i_3-1} dx_1 dx_2 dx_3 \\ &= \int_0^1 \int_0^{1-x_1} x_1^{i_1-1} x_2^{i_2-1} \frac{(1-x_1-x_2)^{i_3}}{i_3} dx_1 dx_2 \\ &= \int_0^1 x_1^{i_1-1} \cdot \frac{B(i_2, i_3+1)}{i_3} (1-x_1)^{i_2+i_3} dx_1 \end{aligned}$$

[by applying the result $\int_0^k x^{i-1} (k-x)^{j-1} dx = k^{i+j-1} B(i, j)$].

$$\begin{aligned} \text{Hence } I &= \frac{B(i_2, i_3+1)}{i_3} \cdot B(i_1, i_2+i_3+1) \\ &= \frac{\Gamma(i_2)\Gamma(i_3)}{\Gamma(i_2+i_3+1)} \frac{\Gamma(i_1)\Gamma(i_2+i_3+1)}{\Gamma(i_1+i_2+i_3+1)} = \frac{\Gamma(i_1)\Gamma(i_2)\Gamma(i_3)}{\Gamma(i_1+i_2+i_3+1)}. \end{aligned}$$

960. Similarly, in the case of four or more variables; but geometrical interpretation fails. It is, however, clear that if we are to integrate

$$I = \iiint\int x_1^{i_1-1} x_2^{i_2-1} x_3^{i_3-1} x_4^{i_4-1} dx_1 dx_2 dx_3 dx_4$$

for positive values of x_1, x_2, x_3, x_4 , which are such that

$$x_1+x_2+x_3+x_4 > 1,$$

(1) when x_1, x_2, x_3 are kept constant, x_4 will range from $x_4=0$ to such value of x_4 as will make

$$1-x_1-x_2-x_3-x_4$$

zero, i.e. from $x_4=0$ to $x_4=1-x_1-x_2-x_3$.

- (2) Having integrated with regard to x_4 , we now keep x_1, x_2 constant, and in integration with regard to x_3 , x_3 must vary from $x_3=0$ to such value as will make $1-x_1-x_2-x_3$ vanish, *i.e.* x_3 must not exceed $1-x_1-x_2$, *i.e.* the limits are 0 and $1-x_1-x_2$.
- (3) Integration with regard to x_4 and x_3 having now been completed, x_1 is to be kept constant whilst integration with regard to x_2 is effected, and x_2 must range from $x_2=0$ to such a value as will not make $1-x_1-x_2$ negative, *i.e.* x_2 must not exceed $1-x_1$. The limits are therefore 0 and $1-x_1$.

(4) Finally, the limits for x_1 are 0 to 1.

Hence

$$\begin{aligned}
 I &= \int_0^1 \int_0^{1-x_1} \int_0^{1-x_1-x_2} \int_0^{1-x_1-x_2-x_3} x_1^{i_1-1} x_2^{i_2-1} x_3^{i_3-1} x_4^{i_4-1} dx_1 dx_2 dx_3 dx_4 \\
 &= \int_0^1 \int_0^{1-x_1} \int_0^{1-x_1-x_2} x_1^{i_1-1} x_2^{i_2-1} x_3^{i_3-1} \frac{(1-x_1-x_2-x_3)^{i_4}}{i_4} dx_1 dx_2 dx_3 \\
 &= \int_0^1 \int_0^{1-x_1} x_1^{i_1-1} x_2^{i_2-1} (1-x_1-x_2)^{i_3+i_4} \frac{B(i_3, i_4+1)}{i_4} dx_1 dx_2 \\
 &= \frac{B(i_3, i_4+1)}{i_4} \int_0^1 x_1^{i_1-1} (1-x_1)^{i_2+i_3+i_4} B(i_2, i_3+i_4+1) dx_1 \\
 &= \frac{B(i_3, i_4+1)}{i_4} B(i_2, i_3+i_4+1) B(i_1, i_2+i_3+i_4+1) \\
 &= \frac{\Gamma(i_3)\Gamma(i_4)}{\Gamma(i_3+i_4+1)} \cdot \frac{\Gamma(i_2)\Gamma(i_3+i_4+1)}{\Gamma(i_2+i_3+i_4+1)} \cdot \frac{\Gamma(i_1)\Gamma(i_2+i_3+i_4+1)}{\Gamma(i_1+i_2+i_3+i_4+1)} \\
 &= \frac{\Gamma(i_1)\Gamma(i_2)\Gamma(i_3)\Gamma(i_4)}{\Gamma(i_1+i_2+i_3+i_4+1)},
 \end{aligned}$$

and the rule indicated obviously holds for any number of integrations, *viz.*

$$\iiint \dots \int x_1^{i_1-1} x_2^{i_2-1} \dots x_n^{i_n-1} dx_1 dx_2 \dots dx_n,$$

for positive values of the variables such that their sum does not exceed unity = $\frac{\Gamma(i_1)\Gamma(i_2)\dots\Gamma(i_n)}{\Gamma(\sigma+1)}$, where $\sigma = i_1 + i_2 + \dots + i_n$.

961. An Extension.

Similarly, if the limiting equation had been

$$x_1 + x_2 + \dots + x_n \succ c \quad (\text{instead of } \succ 1),$$

the limits would have been,

$$\text{for } x_n, \quad \text{from } 0 \text{ to } c - x_1 - x_2 - \dots - x_{n-1};$$

$$\text{for } x_{n-1}, \quad \text{from } 0 \text{ to } c - x_1 - x_2 - \dots - x_{n-2},$$

etc.;

but we may deduce the result from that already obtained by putting

$$x_1 = cx_1', \quad x_2 = cx_2', \quad \text{etc.},$$

so that

$$x_1' + x_2' + \dots \succ 1.$$

Thus we obtain

$$\begin{aligned} I &= c^\sigma \iiint \dots \int (x_1')^{i_1-1} (x_2')^{i_2-1} \dots (x_n')^{i_n-1} dx_1' dx_2' \dots dx_n', \\ &= c^\sigma \frac{\Gamma(i_1) \Gamma(i_2) \dots \Gamma(i_n)}{\Gamma(\sigma+1)}, \quad \text{where } \sigma = i_1 + i_2 + \dots + i_n. \end{aligned}$$

962. DIRICHLET'S THEOREM.

We are now in a position to establish a remarkable theorem due to Gustav Peter Lejeune-Dirichlet,* who was successor to Gauss at Gottingen in 1855.†

The theorem is known as Dirichlet's Theorem, and is of great use in analysis.

The theorem is that when there are any number of variables x_1, x_2, \dots, x_n , and integration is conducted for all positive values limited by the condition

$$\left(\frac{x_1}{a_1}\right)^{p_1} + \left(\frac{x_2}{a_2}\right)^{p_2} + \dots + \left(\frac{x_n}{a_n}\right)^{p_n} \succ 1,$$

then

$$\begin{aligned} I &\equiv \iiint \dots \int x_1^{i_1-1} x_2^{i_2-1} x_3^{i_3-1} \dots x_n^{i_n-1} dx_1 dx_2 dx_3 \dots dx_n \\ &= \frac{a_1^{i_1} a_2^{i_2} \dots a_n^{i_n}}{p_1 p_2 \dots p_n} \cdot \frac{\Gamma\left(\frac{i_1}{p_1}\right) \Gamma\left(\frac{i_2}{p_2}\right) \dots \Gamma\left(\frac{i_n}{p_n}\right)}{\Gamma\left(\frac{i_1}{p_1} + \frac{i_2}{p_2} + \dots + \frac{i_n}{p_n} + 1\right)} = \frac{\prod_1 \left\{ \frac{a_r^{i_r}}{p_r} \Gamma\left(\frac{i_r}{p_r}\right) \right\}}{\Gamma\left(1 + \sum_1 \frac{i_r}{p_r}\right)}, \end{aligned}$$

the several quantities $i_1, i_2, i_3, \dots, i_n; a_1, a_2, \dots, a_n; p_1, p_2, \dots, p_n$, being all positive, and Π denoting the product of the factors indicated.

* Liouville's *Journal*, vol. iv., p. 168.

† *Cajori, Hist. of Math.*, p. 367; Kummer, *Gedächtnissrede auf G. P. Lejeune-Dirichlet*,

The limiting equation $\left(\frac{x_1}{a_1}\right)^{p_1} + \left(\frac{x_2}{a_2}\right)^{p_2} + \dots \geq 1$ may be made linear by the change of variables $\xi_1 = \left(\frac{x_1}{a_1}\right)^{p_1}$, $\xi_2 = \left(\frac{x_2}{a_2}\right)^{p_2}$, etc.,

which give $\frac{1}{\xi_1} \frac{\partial \xi_1}{\partial x_1} = \frac{p_1}{x_1}$, $\frac{1}{\xi_2} \frac{\partial \xi_2}{\partial x_2} = \frac{p_2}{x_2}$, etc.,

and $J' = p_1 p_2 \dots p_n \frac{\xi_1}{x_1} \cdot \frac{\xi_2}{x_2} \cdot \frac{\xi_3}{x_3} \dots \frac{\xi_n}{x_n}$.

The transformed integral is then

$$I \equiv \frac{1}{p_1 p_2 \dots p_n} \iint \dots \int \frac{x_1^{i_1} x_2^{i_2} \dots x_n^{i_n}}{\xi_1 \xi_2 \dots \xi_n} d\xi_1 d\xi_2 \dots d\xi_n \\ = \frac{a_1^{i_1} a_2^{i_2} \dots a_n^{i_n}}{p_1 p_2 \dots p_n} \iint \dots \int \xi_1^{i_1 - 1} \xi_2^{i_2 - 1} \dots \xi_n^{i_n - 1} d\xi_1 d\xi_2 \dots d\xi_n,$$

with the limiting equation $\xi_1 + \xi_2 + \dots + \xi_n \geq 1$;

$$\therefore I = \frac{a_1^{i_1} a_2^{i_2} \dots a_n^{i_n}}{p_1 p_2 \dots p_n} \frac{\Gamma\left(\frac{i_1}{p_1}\right) \Gamma\left(\frac{i_2}{p_2}\right) \dots \Gamma\left(\frac{i_n}{p_n}\right)}{\Gamma\left(\frac{i_1}{p_1} + \frac{i_2}{p_2} + \dots + \frac{i_n}{p_n} + 1\right)} = \frac{\prod_1^n \left\{ \frac{a_r^{i_r}}{p_r} \Gamma\left(\frac{i_r}{p_r}\right) \right\}}{\Gamma\left(1 + \sum_1^n \frac{i_r}{p_r}\right)}$$

as stated.

963. As before, if our limiting condition had been

$$\left(\frac{x_1}{a_1}\right)^{p_1} + \left(\frac{x_2}{a_2}\right)^{p_2} + \dots + \left(\frac{x_n}{a_n}\right)^{p_n} \geq c \text{ (instead of } \geq 1),$$

we should have, after transformation as above,

$$\xi_1 + \xi_2 + \dots + \xi_n \geq c,$$

and making the further transformation

$$\xi_1 = c \xi_1', \quad \xi_2 = c \xi_2', \quad \dots \text{ etc.},$$

$$\xi_1' + \xi_2' + \dots + \xi_n' \geq 1,$$

and the result would be

$$I = \frac{a_1^{i_1} a_2^{i_2} \dots a_n^{i_n}}{p_1 p_2 \dots p_n} c^\sigma \frac{\Gamma\left(\frac{i_1}{p_1}\right) \Gamma\left(\frac{i_2}{p_2}\right) \dots \Gamma\left(\frac{i_n}{p_n}\right)}{\Gamma(\sigma + 1)},$$

where

$$\sigma = \frac{i_1}{p_1} + \frac{i_2}{p_2} + \dots + \frac{i_n}{p_n},$$

$$\text{i.e.} \quad I = c^\sigma \frac{\prod_1^n \left\{ \frac{a_r^{i_r}}{p_r} \Gamma\left(\frac{i_r}{p_r}\right) \right\}}{\Gamma\left(1 + \sum_1^n \frac{i_r}{p_r}\right)}.$$

964. Ex. Find the centroid of an octant of the solid bounded by

$$\left(\frac{x}{a}\right)^{2k} + \left(\frac{y}{b}\right)^{2k} + \left(\frac{z}{c}\right)^{2k} = 1,$$

the volume-density at any point being given by $\rho = \mu x^l y^m z^n$.

Here
$$\bar{x} = \frac{\iiint \rho x \, dx \, dy \, dz}{\iiint \rho \, dx \, dy \, dz} = \frac{\iiint x^{l+1} y^m z^n \, dx \, dy \, dz}{\iiint x^l y^m z^n \, dx \, dy \, dz}.$$

The Numerator =
$$a^{l+2} b^{m+1} c^{n+1} \frac{\Gamma\left(\frac{l+2}{2k}\right) \Gamma\left(\frac{m+1}{2k}\right) \Gamma\left(\frac{n+1}{2k}\right)}{\Gamma\left(\frac{l+2}{2k} + \frac{m+1}{2k} + \frac{n+1}{2k} + 1\right)}.$$

The Denominator =
$$a^{l+1} b^{m+1} c^{n+1} \frac{\Gamma\left(\frac{l+1}{2k}\right) \Gamma\left(\frac{m+1}{2k}\right) \Gamma\left(\frac{n+1}{2k}\right)}{\Gamma\left(\frac{l+1}{2k} + \frac{m+1}{2k} + \frac{n+1}{2k} + 1\right)}.$$

Hence
$$\bar{x} = a \frac{\Gamma\left(\frac{l+2}{2k}\right) \Gamma\left(\frac{l+m+n+3}{2k} + 1\right)}{\Gamma\left(\frac{l+1}{2k}\right) \Gamma\left(\frac{l+m+n+4}{2k} + 1\right)}.$$

In the case of an octant of a uniform ellipsoid $l = m = n = 0, k = 1,$

$$\bar{x} = a \frac{1}{\Gamma\left(\frac{3}{2}\right)} \frac{\Gamma\left(\frac{3}{2}\right)}{\Gamma(3)} = a \cdot \frac{\frac{3}{2} \cdot \frac{1}{2}}{2} = \frac{3}{8}a.$$

Similarly for y and z .

965. **A Particular Case.**

In the case when $p_1 = p_2 = \dots = p_n = 1$

and $a_1 = a_2 = \dots = a_n = a,$

the theorem reduces back to

$$I = \iiint \dots \int x_1^{i_1-1} x_2^{i_2-1} \dots x_n^{i_n-1} dx_1 dx_2 \dots dx_n$$

$$= a^{i_1+i_2+\dots+i_n} \frac{\Gamma(i_1) \Gamma(i_2) \dots \Gamma(i_n)}{\Gamma(i_1+i_2+\dots+i_n+1)},$$

and the limiting equation is

$$x_1 + x_2 + \dots + x_n \geq a,$$

viz. the fundamental case of Art. 961 assumed.

966. **Extension.**

If the lower limits had not been zero in each case, but such that $x_1 + x_2 + \dots + x_n$ is to be not less than b nor greater than $a,$

i.e. $b < \Sigma x_r < a$; then plainly we must subtract from the result obtained, the integral found by making

$$x_1 + x_2 + \dots + x_n \geq b,$$

and the result will be

$$[a^{i_1+i_2+\dots+i_n} - b^{i_1+i_2+\dots+i_n}] \frac{\Gamma(i_1)\Gamma(i_2)\dots\Gamma(i_n)}{\Gamma(i_1+i_2+\dots+i_n+1)}.$$

967. If the difference between a and b be an infinitesimal difference δb , then to the first order

$$\begin{aligned} a^{i_1+i_2+\dots+i_n} - b^{i_1+i_2+\dots+i_n} &= (b + \delta b)^{i_1+i_2+\dots+i_n} - b^{i_1+i_2+\dots+i_n} \\ &= (i_1+i_2+\dots+i_n)b^{i_1+i_2+\dots+i_n-1}\delta b, \end{aligned}$$

and the result will be

$$b^{i_1+i_2+\dots+i_n-1}\delta b \frac{\Gamma(i_1)\Gamma(i_2)\Gamma(i_3)\dots\Gamma(i_n)}{\Gamma(i_1+i_2+\dots+i_n)}.$$

For example, to verify this in a simple case, consider the volume of a triangular plate bounded by the coordinate planes, and the planes

$$x + y + z = b \quad \text{and} \quad x + y + z = b + \delta b.$$

Here

$$\begin{aligned} i_1 = i_2 = i_3 = 1, \quad p_1 = p_2 = p_3 = 1, \\ V = b^2 \delta b \cdot \frac{1 \cdot 1 \cdot 1}{2} = \frac{1}{2} b^2 \delta b = \delta \left(\frac{b}{3} \cdot \frac{b^2}{2} \right), \end{aligned}$$

i.e. the change in the volume of the tetrahedron bounded by the coordinate planes, and the plane which makes intercepts b on the axes, when b increases to $b + \delta b$.

968. Liouville's Extension.

If we require to find the value of

$$I = \iiint \dots \int x_1^{i_1-1} x_2^{i_2-1} \dots x_n^{i_n-1} f(x_1 + x_2 + \dots + x_n) dx_1 dx_2 \dots dx_n,$$

subject to the conditions that x_1, x_2, \dots, x_n are all positive, but

$$x_1 + x_2 + \dots + x_n \geq a \quad \text{and} \quad \leq b,$$

we may then take the case when

$$x_1 + x_2 + \dots + x_n$$

lies between v and $v + \delta v$, for which

$$x_1 + x_2 + \dots + x_n$$

differs from v by an infinitesimal ϵ .

Then for this limitation the integral takes the value

$$\begin{aligned} v^{i_1+i_2+\dots+i_n-1} \delta v f(v + \epsilon) \frac{\Gamma(i_1)\Gamma(i_2)\dots\Gamma(i_n)}{\Gamma(i_1+\dots+i_n)} \\ = v^{i_1+i_2+\dots+i_n-1} \delta v f(v) \frac{\Gamma(i_1)\dots\Gamma(i_n)}{\Gamma(i_1+\dots+i_n)} \end{aligned}$$

to the first order of infinitesimals. And therefore, for the whole range of values from $v=b$ to $v=a$,

$$I = \frac{\Gamma(i_1)\Gamma(i_2)\dots\Gamma(i_n)}{\Gamma(i_1+i_2+\dots+i_n)} \int_b^a v^{i_1+i_2+\dots+i_n-1} f(v) dv.$$

969. Exactly in the same way, if we require

$$I = \iint \dots \int x_1^{i_1-1} \dots x_n^{i_n-1} f\left\{\left(\frac{x_1}{a_1}\right)^{p_1} + \dots + \left(\frac{x_n}{a_n}\right)^{p_n}\right\} dx_1 \dots dx_n$$

for all positive values of the variables such that

$$\left(\frac{x_1}{a_1}\right)^{p_1} + \left(\frac{x_2}{a_2}\right)^{p_2} + \dots + \left(\frac{x_n}{a_n}\right)^{p_n} \succ h_1 \text{ and } \prec h_2.$$

Let
$$\left(\frac{x_1}{a_1}\right)^{p_1} + \left(\frac{x_2}{a_2}\right)^{p_2} + \dots + \left(\frac{x_n}{a_n}\right)^{p_n}$$

lie between v and $v+\delta v, = v+\epsilon$, say, where ϵ is an infinitesimal.

Then for this limitation,

$$\left[I \right]_v^{v+\delta v} = \frac{a_1^{i_1} a_2^{i_2} \dots a_n^{i_n}}{p_1 p_2 \dots p_n} v^{k-1} \delta v f(v+\epsilon) \frac{\Gamma\left(\frac{i_1}{p_1}\right) \Gamma\left(\frac{i_2}{p_2}\right) \dots \Gamma\left(\frac{i_n}{p_n}\right)}{\Gamma(k)},$$

where
$$k = \frac{i_1}{p_1} + \frac{i_2}{p_2} + \dots + \frac{i_n}{p_n},$$

and $\delta v f(v+\epsilon)$ differs from $f(v) \delta v$ by a second-order infinitesimal at most, supposing $f(v)$ and $f'(v)$ finite and continuous for the range. Hence in the limit, when we integrate with regard to v from $v=h_2$ to $v=h_1$,

$$I = \frac{a_1^{i_1} a_2^{i_2} \dots a_n^{i_n}}{p_1 p_2 \dots p_n} \frac{\Gamma\left(\frac{i_1}{p_1}\right) \Gamma\left(\frac{i_2}{p_2}\right) \dots \Gamma\left(\frac{i_n}{p_n}\right)}{\Gamma\left(\frac{i_1}{p_1} + \frac{i_2}{p_2} + \dots + \frac{i_n}{p_n}\right)} \int_{h_2}^{h_1} v^{k-1} f(v) dv,$$

where
$$k = \frac{i_1}{p_1} + \frac{i_2}{p_2} + \dots + \frac{i_n}{p_n}.$$

This extension of Dirichlet's theorem is due to Liouville.*

970. An Application.

As an example of this theorem, consider

$$\iint \dots \int \sqrt{a^2 - x_1^2 - x_2^2 - \dots - x_n^2}$$

for positive values of the variables with the condition

$$x_1^2 + x_2^2 + \dots + x_n^2 = va^2 \succ a^2.$$

* Liouville's *Journal*, vol. iv., p. 231.

Here $p_1 = p_2 = \dots = p_n = 2$, $i_1 = i_2 = \dots = i_n = 1$,

$$a_1 = a_2 = \dots = a_n = a; \quad h_1 = 1, \quad h_2 = 0, \quad k = \frac{n}{2}$$

$$\begin{aligned} \text{Then } I &= \frac{\alpha^n}{2^n} \frac{\left[\Gamma\left(\frac{1}{2}\right)\right]^n}{\Gamma\left(\frac{n}{2}\right)} \int_0^1 \frac{v^{\frac{n}{2}-1}}{\alpha\sqrt{1-v}} dv = \frac{\alpha^{n-1}}{2^n} \frac{\left[\Gamma\left(\frac{1}{2}\right)\right]^n}{\Gamma\left(\frac{n}{2}\right)} \int_0^1 v^{\frac{n}{2}-1} (1-v)^{\frac{1}{2}-1} dv \\ &= \frac{\alpha^{n-1}}{2^n} \frac{\left[\Gamma\left(\frac{1}{2}\right)\right]^n}{\Gamma\left(\frac{n}{2}\right)} \cdot \frac{\Gamma\left(\frac{n}{2}\right)\Gamma\left(\frac{1}{2}\right)}{\Gamma\left(\frac{n+1}{2}\right)} = \frac{\alpha^{n-1}}{2^n} \frac{\pi^{\frac{n+1}{2}}}{\Gamma\left(\frac{n+1}{2}\right)}. \end{aligned}$$

Thus, for example, in the case $n=2$,

$$\iint \frac{dx_1 dx_2}{\sqrt{a^2 - x_1^2 - x_2^2}} = \frac{a}{4} \frac{\pi^{\frac{3}{2}}}{\frac{1}{2}\pi^{\frac{1}{2}}} = \frac{\pi a}{2}.$$

Hence the area of the portion of a sphere $x^2 + y^2 + z^2 = a^2$ which lies in the first octant, and which is

$$\iint \frac{dx dy}{z}, \quad \text{i.e. } a \iint \frac{dx dy}{\sqrt{a^2 - x^2 - y^2}}, \quad \text{is } = a \cdot \frac{\pi a}{2},$$

and the area of the surface of the whole sphere $= 4\pi a^2$.

$$\text{Again } (n=3), \quad \iiint \frac{dx_1 dx_2 dx_3}{\sqrt{a^2 - x_1^2 - x_2^2 - x_3^2}} = \frac{\pi^2 a^2}{8}$$

(Gregory's *Examples*, p. 474).

$$\text{and } (n=4), \quad \iiint \frac{dx_1 dx_2 dx_3 dx_4}{\sqrt{a^2 - x_1^2 - x_2^2 - x_3^2 - x_4^2}} = \frac{a^3}{16} \frac{\pi^{\frac{5}{2}}}{\Gamma\left(\frac{5}{2}\right)} = \frac{\pi^3 a^3}{12},$$

etc.

971. Boole's Theorem.

Consider $I = \iiint \dots \int F(a_1 x_1 + a_2 x_2 + \dots + a_n x_n) dx_1 dx_2 \dots dx_n$ for all real values of x_1, x_2, \dots, x_n negative or positive, such that

$$x_1^2 + x_2^2 + \dots \leq c^2.$$

Change the variables by the orthogonal transformation in the margin.

Then $J=1$ and the relations of the transformation system are

$$\sum l^2 = 1, \quad \text{etc.},$$

$$\sum m = 0, \quad \text{etc.},$$

$$\text{and } \sum_1^n x_r^2 = \sum_1^n u_r^2;$$

	u_1	u_2	u_3	...
x_1	l_1	l_2	l_3	...
x_2	m_1	m_2	m_3	...
x_3	n_1	n_2	n_3	...
...

* Gregory's *Examples*, p. 474.

and suppose the transformation to have been so chosen that

$$a_1x_1 + a_2x_2 + \dots + a_nx_n = ku_1, \quad \text{where } k^2 = \sum_1^n a_r^2.$$

Then
$$I = \int \dots \int_{(n \text{ signs})} F(ku_1) du_1 du_2 \dots du_n.$$

Now for the first $n-1$ integrations, u_1 remains constant, and

$$\int \dots \int_{(n-1 \text{ signs})} du_2 du_3 \dots du_n,$$

where

$$\begin{aligned} u_2^2 + u_3^2 + \dots + u_n^2 &\not\geq c^2 - u_1^2, \\ &= 2^{n-1} \frac{(c^2 - u_1^2)^{\frac{n-1}{2}}}{2^{n-1}} \frac{(\Gamma \frac{1}{2})^{n-1}}{\Gamma(\frac{n+1}{2})}, \end{aligned}$$

the first factor 2^{n-1} occurring because at each of the $n-1$ integrations the result is to be doubled to take into account the possible negative signs of the respective variables. Hence, dropping the suffix, we have

$$I = \frac{\pi^{\frac{n-1}{2}}}{\Gamma(\frac{n+1}{2})} \int_{-c}^c F(ku) (c^2 - u^2)^{\frac{n-1}{2}} du.$$

(See "Catalan's Theorem," Liouville's *Journal*, vol. vi., p. 81, and Boole's remarks upon it, *Cambridge Math. Journal*, vol. iii., p. 277.)

972. Consider next the integration

$$I = \int \dots \int_{(n \text{ signs})} \frac{F(a_1x_1 + a_2x_2 + \dots + a_nx_n)}{\sqrt{c^2 - x_1^2 - x_2^2 - \dots - x_n^2}} dx_1 dx_2 \dots dx_n,$$

where $x_1^2 + x_2^2 + \dots + x_n^2 \not\geq c^2,$

for real values of $x_1, x_2, \dots, x_n.$

Changing the variables by the same orthogonal transformation as before,

$$I = \int \dots \int_{(n \text{ signs})} \frac{F(ku_1)}{\sqrt{c^2 - u_1^2 - u_2^2 - u_3^2 \dots - u_n^2}} du_1 du_2 \dots du_n.$$

Now for the first $n-1$ integrations, u_1 remains a constant, and

$$\int \dots \int_{(n-1 \text{ signs})} \frac{du_2 du_3 \dots du_n}{(c^2 - u_1^2 - u_2^2 - u_3^2 \dots - u_n^2)^{\frac{1}{2}}} = 2^{n-1} \frac{(c^2 - u_1^2)^{\frac{n-1}{2}}}{2^{n-1}} \frac{\pi^{\frac{n}{2}}}{\Gamma(\frac{n}{2})},$$

by Art. 970, the first factor 2^{n-1} being introduced because the several variables are not now restricted as to sign as was the case in Art. 970, so that at each of the $(n-1)$ integrations the result must be doubled. Also at the final integration the limits must be $-c$ to $+c$ for the same reason. Hence, dropping the suffix,

$$I = \frac{\pi^{\frac{n}{2}}}{\Gamma\left(\frac{n}{2}\right)} \int_{-c}^c F(ku)(c^2 - u^2)^{\frac{n}{2}-1} du.*$$

973. Further Generalisation.

We next consider the still more general integral

$$I = \iint \dots \int F\left(\frac{x_1^2}{a_1^2} + \dots + \frac{x_n^2}{a_n^2}\right) f(A_1 x_1 + \dots + A_n x_n) dx_1 \dots dx_n$$

for all real values of x_1, x_2, \dots, x_n , such that

$$\frac{x_1^2}{a_1^2} + \frac{x_2^2}{a_2^2} + \dots + \frac{x_n^2}{a_n^2} \leq 1.$$

First we expand $F(v)$ in powers of $1-v$, say $\sum B_p(1-v)^p$ [or if it be possible to expand in positive *integral* powers of $1-v$, we may write $1-v=w$; then $F(v)=F(1-w)$, and by Maclaurin's theorem, we may put

$$F(v) = F(1) - wF'(1) + \frac{w^2}{2!} F''(1) - \dots + (-1)^p \frac{w^p}{p!} F^{(p)}(1) + \dots \Big].$$

Then we consider the integration of

$$\iint \dots \int \left(1 - \frac{x_1^2}{a_1^2} - \dots - \frac{x_n^2}{a_n^2}\right)^p f(A_1 x_1 + \dots + A_n x_n) dx_1 \dots dx_n.$$

If I_p be the result of this integration, the whole result will be

$$\sum B_p I_p$$

[or $I_0 F(1) - I_1 F'(1) + \frac{I_2}{2!} F''(1) - \dots + (-1)^p \frac{I_p}{p!} F^{(p)}(1) + \dots$,
as the case may be].

To obtain I_p , first put

$$x_1 = a_1 \xi_1, \quad x_2 = a_2 \xi_2, \quad x_3 = a_3 \xi_3, \quad \dots \quad x_n = a_n \xi_n.$$

Then $J = a_1 a_2 \dots a_n$ and

$$\frac{I_p}{a_1 a_2 \dots a_n} = \iint \dots \int (1 - \xi_1^2 - \dots - \xi_n^2)^p f(A_1 a_1 \xi_1 + \dots + A_n a_n \xi_n) d\xi_1 \dots d\xi_n.$$

* See Todhunter, *D.C.*, Art. 281; Gregory, *D. and I.C.*, p. 474.

Now make a further transformation to variables u_1, u_2, \dots, u_n by the orthogonal transformation formulae in the margin. The Jacobian of this system is unity, and

$$\xi_1^2 + \xi_2^2 + \dots = u_1^2 + u_2^2 + \dots ;$$

and further choose u_1 to be

$$(A_1 u_1 \xi_1 + A_2 u_2 \xi_2 + \dots) / k,$$

where $k^2 = A_1^2 u_1^2 + \dots + A_n^2 u_n^2$.

	u_1	u_2	...	u_n
ξ_1	l_1	l_2	...	l_n
ξ_2	m_1	m_2	...	m_n
...
ξ_n

$$\text{Then } I_p = a_1 \dots a_n \iint \dots \int (1 - u_1^2 - \dots - u_n^2)^p f(ku_1) du_1 \dots du_n.$$

In the integration with regard to u_2, u_3, \dots, u_n , the remaining variable u_1 remains constant, and

$$\begin{aligned} & \iint \dots \int_{(n-1 \text{ signs})} (1 - u_1^2 - u_2^2 - \dots - u_n^2)^p du_2 du_3 \dots du_n, \\ &= \frac{1}{2^{n-1}} \frac{\left[\Gamma\left(\frac{1}{2}\right) \right]^{n-1}}{\Gamma\left(\frac{n-1}{2}\right)} \int_0^{1-u_1^2} z^{\frac{n-1}{2}-1} (1 - u_1^2 - z)^p dz, \end{aligned}$$

if restricted to positive values of u_2, u_3 , etc.; and if the several variables may have full scope as to sign between the specified limits, each of these $n-1$ integrations must be doubled.

The result of the $n-1$ integrations is in that case

$$\begin{aligned} & \frac{\Gamma\left(\frac{1}{2}\right)^{n-1}}{\Gamma\left(\frac{n-1}{2}\right)} \frac{\Gamma\left(\frac{n-1}{2}\right) \Gamma(p+1)}{\Gamma\left(\frac{n+1}{2} + p\right)} (1 - u_1^2)^{\frac{n-1}{2} + p} \\ &= \frac{\pi^{\frac{n-1}{2}} \Gamma(p+1)}{\Gamma\left(\frac{n+1}{2} + p\right)} (1 - u_1^2)^{\frac{n-1}{2} + p}. \end{aligned}$$

Therefore, as the limits of the final integration with regard to u_1 are from -1 to $+1$,

$$I_p = a_1 a_2 \dots a_n \frac{\pi^{\frac{n-1}{2}} \Gamma(p+1)}{\Gamma\left(\frac{n+1}{2} + p\right)} \int_{-1}^1 (1 - u^2)^{\frac{n-1}{2} + p} f(ku) du,$$

it being now unnecessary to retain the suffix of the u . Hence

$$I = a_1 a_2 \dots a_n \pi^{\frac{n-1}{2}} \Sigma B_p \frac{\Gamma(p+1)}{\Gamma\left(\frac{n+1}{2} + p\right)} \int_{-1}^1 (1-u^2)^{\frac{n-1}{2}+p} f(ku) du,$$

where $k^2 = A_1^2 a_1^2 + A_2^2 a_2^2 + \dots + A_n^2 a_n^2$.

This result, of course, includes former cases discussed.

974. Extension.

If the limits had been defined so that

$$x_1^2/a_1^2 + x_2^2/a_2^2 + \dots + x_n^2/a_n^2 \succ \alpha^2 \quad (\text{instead of } \succ 1),$$

we could deduce the new result from the former by writing

$$a_1 \alpha \text{ in place of } a_1, \quad a_2 \alpha \text{ in place of } a_2, \quad \text{and so on,}$$

and therefore $k \alpha$ in place of k ;

and, finally, if the scope of the range of the variables is still further limited by

$$x_1^2/a_1^2 + \dots + x_n^2/a_n^2 \succ \alpha^2 \quad \text{and} \quad \prec \beta^2,$$

we must subtract all cases for which $x_1^2/a_1^2 + \dots + x_n^2/a_n^2$ is $\succ \beta^2$, and we shall have

$$\begin{aligned} & I/a_1 a_2 \dots a_n \pi^{\frac{n-1}{2}} \\ &= \Sigma B_p \frac{\Gamma(p+1)}{\Gamma\left(\frac{n+1}{2} + p\right)} \int_{-1}^1 (1-u^2)^{\frac{n-1}{2}+p} [a^n f(kau) - \beta^n f(k\beta u)] du. \end{aligned}$$

975. Deductions.

Compare with the foregoing results the series of integrals

$$\int x_1^{i_1-1} x_2^{i_2-1} dx_1, \quad \text{where } x_1 + x_2 = 1,$$

$$\iint x_1^{i_1-1} x_2^{i_2-1} x_3^{i_3-1} dx_1 dx_2, \quad \text{where } x_1 + x_2 + x_3 = 1,$$

etc.,

$$\iiint \dots \int x_1^{i_1-1} \dots x_n^{i_n-1} dx_1 \dots dx_{n-1}, \quad \text{where } x_1 + \dots + x_{n-1} + x_n = 1,$$

for positive values of the several variables.

Take for instance the second. Here $x_3 = 1 - x_1 - x_2$, and the integration

$$I \equiv \iint x_1^{i_1-1} x_2^{i_2-1} (1-x_1-x_2)^{i_3-1} dx_1 dx_2$$

is to be conducted for all positive values of x_1, x_2 , such that $x_1 + x_2 \geq 1$,

$$\begin{aligned} \text{Then } I &= \frac{\Gamma(i_1)\Gamma(i_2)}{\Gamma(i_1+i_2)} \int_0^1 v^{i_1+i_2-1}(1-v)^{i_3-1} dv \\ &= \frac{\Gamma(i_1)\Gamma(i_2)}{\Gamma(i_1+i_2)} \frac{\Gamma(i_1+i_2)\Gamma(i_3)}{\Gamma(i_1+i_2+i_3)} = \frac{\Gamma(i_1)\Gamma(i_2)\Gamma(i_3)}{\Gamma(i_1+i_2+i_3)}. \end{aligned}$$

976. Similarly, in the general case,

$$I = \int \dots \int_{(n-1 \text{ signs})} x_1^{i_1-1} x_2^{i_2-1} \dots x_{n-1}^{i_{n-1}-1} x_n^{i_n-1} dx_1 dx_2 \dots dx_{n-1}$$

for positive values of x_1, x_2, \dots, x_n , such that $x_1 + \dots + x_{n-1} + x_n = 1$,

$$I = \int \dots \int_{(n-1 \text{ signs})} x_1^{i_1-1} \dots x_{n-1}^{i_{n-1}-1} (1-x_1-\dots-x_{n-1})^{i_n-1} dx_1 \dots dx_{n-1},$$

where $x_1 + x_2 + \dots + x_{n-1} \geq 1$

$$\begin{aligned} &= \frac{\Gamma(i_1)\Gamma(i_2)\dots\Gamma(i_{n-1})}{\Gamma(i_1+i_2+\dots+i_{n-1})} \int_0^1 v^{i_1+i_2+\dots+i_{n-1}-1} (1-v)^{i_n-1} dv \\ &= \frac{\Gamma(i_1)\Gamma(i_2)\dots\Gamma(i_{n-1})}{\Gamma(i_1+i_2+\dots+i_{n-1})} \frac{\Gamma(i_1+i_2+\dots+i_{n-1})\Gamma(i_n)}{\Gamma(i_1+i_2+\dots+i_{n-1}+i_n)} \\ &= \frac{\Gamma(i_1)\Gamma(i_2)\dots\Gamma(i_n)}{\Gamma(i_1+i_2+\dots+i_n)}. \end{aligned}$$

Thus, if $A \equiv \int \dots \int_{(n \text{ signs})} x_1^{i_1-1} \dots x_n^{i_n-1} dx_1 \dots dx_n$, for $\sum_1^n x_r \geq 1$,

and $B \equiv \int \dots \int_{(n-1 \text{ signs})} x_1^{i_1-1} \dots x_{n-1}^{i_{n-1}-1} dx_1 \dots dx_{n-1}$, for $\sum_1^n x_r = 1$,

we have $(i_1 + i_2 + \dots + i_n)A = B = \frac{\Gamma(i_1)\Gamma(i_2)\dots\Gamma(i_n)}{\Gamma(i_1+i_2+\dots+i_n)}$.

977. In the same way, if we require the value of

$$I = \int \dots \int_{(n-1 \text{ signs})} x_1^{i_1-1} x_2^{i_2-1} \dots x_{n-1}^{i_{n-1}-1} x_n^{i_n-p_n} dx_1 dx_2 \dots dx_{n-1}.$$

for positive values of the variables, such that

$$\left(\frac{x_1}{a_1}\right)^{p_1} + \left(\frac{x_2}{a_2}\right)^{p_2} + \dots + \left(\frac{x_{n-1}}{a_{n-1}}\right)^{p_{n-1}} + \left(\frac{x_n}{a_n}\right)^{p_n} = 1,$$

we have
$$x_n = \alpha_n \left\{ 1 - \left(\frac{x_1}{\alpha_1} \right)^{p_1} - \dots - \left(\frac{x_{n-1}}{\alpha_{n-1}} \right)^{p_{n-1}} \right\}^{\frac{1}{p_n}},$$

and
$$I = \iiint \dots \int x_1^{i_1-1} x_2^{i_2-1} \dots x_{n-1}^{i_{n-1}-1} \alpha_n^{i_n-p_n} \times \left\{ 1 - \left(\frac{x_1}{\alpha_1} \right)^{p_1} - \dots - \left(\frac{x_{n-1}}{\alpha_{n-1}} \right)^{p_{n-1}} \right\}^{i_n-1} dx_1 dx_2 \dots dx_{n-1},$$

where
$$\left(\frac{x_1}{\alpha_1} \right)^{p_1} + \dots + \left(\frac{x_{n-1}}{\alpha_{n-1}} \right)^{p_{n-1}} \leq 1,$$

$$= \frac{\alpha_1^{i_1} \dots \alpha_{n-1}^{i_{n-1}} \alpha_n^{i_n-p_n}}{p_1 \dots p_{n-1}} \frac{\Gamma\left(\frac{i_1}{p_1}\right) \dots \Gamma\left(\frac{i_{n-1}}{p_{n-1}}\right)}{\Gamma\left(\frac{i_1}{p_1} + \dots + \frac{i_{n-1}}{p_{n-1}}\right)} \int_0^1 v^{\lambda-1} (1-v)^{i_n-1} dv,$$

where
$$\lambda = \frac{i_1}{p_1} + \frac{i_2}{p_2} + \dots + \frac{i_{n-1}}{p_{n-1}};$$

$$\therefore I = \frac{p_n}{\alpha_n^{p_n}} \frac{\alpha_1^{i_1} \alpha_2^{i_2} \dots \alpha_n^{i_n}}{p_1 p_2 \dots p_n} \frac{\Gamma\left(\frac{i_1}{p_1}\right) \Gamma\left(\frac{i_2}{p_2}\right) \dots \Gamma\left(\frac{i_n}{p_n}\right)}{\Gamma\left(\frac{i_1}{p_1} + \frac{i_2}{p_2} + \dots + \frac{i_n}{p_n}\right)}.$$

978. Ex. Find the value of $\iiint v^{\lambda-1} \mu^{\mu-1} z^{\nu-1} dx dy$ for all points of the ellipsoidal surface $x^2/a^2 + y^2/b^2 + z^2/c^2 = 1$ which lie in the positive octant.

Here $i_1 = \lambda, i_2 = \mu, i_3 = \nu + 1, p_1 = p_2 = p_3 = 2, \alpha_1 = a, \alpha_2 = b, \alpha_3 = c,$

$$I = \frac{2}{c^2} \frac{2}{a^2} \frac{2}{b^2} \frac{2}{c^2} \frac{\Gamma\left(\frac{\lambda}{2}\right) \Gamma\left(\frac{\mu}{2}\right) \Gamma\left(\frac{\nu+1}{2}\right)}{\Gamma\left(\frac{\lambda}{2} + \frac{\mu}{2} + \frac{\nu+1}{2}\right)}.$$

Thus, for instance,

$$\iiint z dx dy = \frac{2}{c^2} \frac{2}{a^2} \frac{2}{b^2} \frac{2}{c^2} \frac{\pi \Gamma\left(\frac{3}{2}\right)}{\Gamma\left(\frac{3}{2}\right)} = \frac{4}{3} \pi abc.$$

979. **Relation of the Integral Forms discussed.**

We note then that the two integrals

$$A \equiv \iiint \dots \int x_1^{i_1-1} x_2^{i_2-1} \dots x_n^{i_n-1} dx_1 dx_2 \dots dx_n, \text{ for } \sum_1^n \left(\frac{x_r}{\alpha_r}\right)^{p_r} \leq 1,$$

(n signs)

$$B \equiv \iiint \dots \int x_1^{i_1-1} x_2^{i_2-1} \dots x_{n-1}^{i_{n-1}-1} x_n^{i_n-p_n} dx_1 dx_2 \dots dx_{n-1}, \text{ for } \sum_1^n \left(\frac{x_r}{\alpha_r}\right)^{p_r} = 1,$$

(n-1 signs)

for positive values of the variables in each case, are so related that

$$\sum_1^n \frac{i_r}{p_r} A = \frac{a_n p_n}{p_n} B = \frac{a_1^{i_1} a_2^{i_2} \dots a_n^{i_n}}{p_1 p_2 \dots p_n} \frac{\Gamma\left(\frac{i_1}{p_1}\right) \Gamma\left(\frac{i_2}{p_2}\right) \dots \Gamma\left(\frac{i_n}{p_n}\right)}{\Gamma\left(\frac{i_1}{p_1} + \frac{i_2}{p_2} + \dots + \frac{i_n}{p_n}\right)}.$$

980. A LEMMA.

In order to abbreviate the work of the articles which follow, let us note that the Binomial expansion

$$(1-z)^{-n} = 1 + nz + \frac{n(n+1)}{2!} z^2 + \dots + \frac{n(n+1)\dots(n+r-1)}{r!} z^r + \dots$$

may be written as $\sum_0^\infty K_r^{(n)} z^r$, where $K_r^{(n)} = \frac{\Gamma(n+r)}{\Gamma(n)} \frac{1}{r!}$,

and that, writing $i_1 + i_2 = j_2$, $i_1 + i_2 + i_3 = j_3$, etc., we have

$$\begin{aligned} K_r^{(n)} \frac{\Gamma(i_1) \Gamma(i_2+r)}{\Gamma(i_1+i_2+r)} &= \frac{\Gamma(j_2+r)}{\Gamma(j_2)r!} \cdot \frac{\Gamma(i_1) \Gamma(i_2+r)}{\Gamma(j_2+r)} \\ &= \frac{\Gamma(i_1) \Gamma(i_2)}{\Gamma(j_2)} \cdot \frac{\Gamma(i_2+r)}{\Gamma(i_2)r!} = \frac{\Gamma(i_1) \Gamma(i_2)}{\Gamma(i_1+i_2)} K_r^{(i_2)}, \end{aligned}$$

$$\begin{aligned} K_r^{(n)} \frac{\Gamma(i_1) \Gamma(i_2) \Gamma(i_3+r)}{\Gamma(i_1+i_2+i_3+r)} &= \frac{\Gamma(j_3+r)}{\Gamma(j_3)r!} \cdot \frac{\Gamma(i_1) \Gamma(i_2) \Gamma(i_3+r)}{\Gamma(j_3+r)} \\ &= \frac{\Gamma(i_1) \Gamma(i_2) \Gamma(i_3)}{\Gamma(j_3)} \cdot \frac{\Gamma(i_3+r)}{\Gamma(i_3)r!} = \frac{\Gamma(i_1) \Gamma(i_2) \Gamma(i_3)}{\Gamma(i_1+i_2+i_3)} K_r^{(i_3)}, \end{aligned}$$

etc.,

and

$$\begin{aligned} K_\rho^{(n, i_1)} \frac{\Gamma(i_1) \Gamma(i_2+\rho) \Gamma(i_3+r)}{\Gamma(i_1+i_2+\rho+i_3+r)} &= \frac{\Gamma(j_3+r+\rho)}{\Gamma(j_3+r)\rho!} \cdot \frac{\Gamma(i_1) \Gamma(i_2+\rho) \Gamma(i_3+r)}{\Gamma(j_3+\rho+r)} \\ &= \frac{\Gamma(i_1) \Gamma(i_2) \Gamma(i_3+r)}{\Gamma(j_3+r)} \cdot \frac{\Gamma(i_2+\rho)}{\Gamma(i_2)\rho!} = \frac{\Gamma(i_1) \Gamma(i_2) \Gamma(i_3+r)}{\Gamma(i_1+i_2+i_3+r)} K_\rho^{(i_2)}, \end{aligned}$$

etc.

981. We propose now to consider integrals of the class

$$I_n = \iiint \dots \int \frac{x_1^{i_1-1} x_2^{i_2-1} \dots x_n^{i_n-1} f\left(\sum_1^n A_r x_r\right) dx_1 dx_2 \dots dx_n}{(\lambda + a_1 x_1 + a_2 x_2 + \dots + a_n x_n)^{i_1+i_2+\dots+i_n}}$$

for all positive values of the variables, such that

$$h_1 < A_1 x_1 + A_2 x_2 + \dots + A_n x_n < h_2,$$

all the letters involved representing positive quantities.

Putting

$$A_1 x_1 = \xi_1, \quad A_2 x_2 = \xi_2, \quad \text{etc.,} \quad \text{and} \quad \frac{a_1}{A_1} = b_1, \quad \frac{a_2}{A_2} = b_2, \quad \text{etc.,}$$

$$I_n = \frac{1}{A_1^{i_1} A_2^{i_2} \dots A_n^{i_n}} \iint \dots \int \frac{\xi_1^{i_1-1} \dots \xi_n^{i_n-1} f(\xi_1 + \dots + \xi_n) d\xi_1 \dots d\xi_n}{(\lambda + b_1 \xi_1 + b_2 \xi_2 + \dots + b_n \xi_n)^{i_1+i_2+\dots+i_n}}$$

Consider first the case of a double integral,

$$I_2 = \frac{1}{A_1^{i_1} A_2^{i_2}} \iint \frac{\xi_1^{i_1-1} \xi_2^{i_2-1} f(\xi_1 + \xi_2)}{(\lambda + b_1 \xi_1 + b_2 \xi_2)^{i_1+i_2}} d\xi_1 d\xi_2,$$

a particular case of which is discussed by Todhunter (*Int. Calc.*, p. 263). Of the two quantities b_1, b_2 , let b_1 be the one which is not less than the other. Then

$$\lambda + b_1 \xi_1 + b_2 \xi_2 \equiv (\lambda + b_1(\xi_1 + \xi_2)) - (b_1 - b_2)\xi_2, \quad = u - v, \quad \text{say,}$$

where $v = (b_1 - b_2)\xi_2$. Then as $\lambda + b_1 \xi_1 + b_2 \xi_2$ is a positive quantity, we have $v < u$, and

$$\begin{aligned} (\lambda + b_1 \xi_1 + b_2 \xi_2)^{-(i_1+i_2)} &= (u-v)^{-(i_1+i_2)} = u^{-(i_1+i_2)} \left(1 - \frac{v}{u}\right)^{-(i_1+i_2)} \\ &= u^{-(i_1+i_2)} \sum_0^{\infty} K_r^{(i_1+i_2)} (b_1 - b_2)^r \left(\frac{\xi_2}{u}\right)^r, \end{aligned}$$

a convergent binomial expansion. Hence the integral becomes

$$\begin{aligned} &\frac{1}{A_1^{i_1} A_2^{i_2}} \iint \frac{\xi_1^{i_1-1} \xi_2^{i_2-1} f(\xi_1 + \xi_2)}{u^{(i_1+i_2)}} \sum_0^{\infty} K_r^{(i_1+i_2)} (b_1 - b_2)^r \left(\frac{\xi_2}{u}\right)^r d\xi_1 d\xi_2 \\ &= \frac{1}{A_1^{i_1} A_2^{i_2}} \sum_0^{\infty} K_r^{(i_1+i_2)} (b_1 - b_2)^r \iint \frac{\xi_1^{i_1-1} \xi_2^{i_2+r-1} f(\xi_1 + \xi_2)}{u^{i_1+i_2+r}} d\xi_1 d\xi_2, \end{aligned}$$

and u being a function of $\xi_1 + \xi_2$, we have, by Art. 968,

$$\begin{aligned} I_2 &= \frac{1}{A_1^{i_1} A_2^{i_2}} \sum_0^{\infty} K_r^{(i_1+i_2)} (b_1 - b_2)^r \frac{\Gamma(i_1) \Gamma(i_2+r)}{\Gamma(i_1+i_2+r)} \int_{h_1}^{h_2} \frac{t^{i_1+i_2+r-1} f(t)}{(\lambda + b_1 t)^{i_1+i_2+r}} dt \\ &= \frac{1}{A_1^{i_1} A_2^{i_2}} \sum_0^{\infty} \frac{\Gamma(i_1) \Gamma(i_2)}{\Gamma(i_1+i_2)} K_r^{(i_1+i_2)} (b_1 - b_2)^r \int_{h_1}^{h_2} \frac{t^{i_1+i_2+r-1} f(t)}{(\lambda + b_1 t)^{i_1+i_2+r}} dt \\ &= \frac{1}{A_1^{i_1} A_2^{i_2}} \frac{\Gamma(i_1) \Gamma(i_2)}{\Gamma(i_1+i_2)} \int_{h_1}^{h_2} \frac{t^{i_1+i_2-1} f(t)}{(\lambda + b_1 t)^{i_1+i_2}} \sum_0^{\infty} K_r^{(i_1+i_2)} (b_1 - b_2)^r \frac{t^r}{(\lambda + b_1 t)^r} dt \\ &= \frac{1}{A_1^{i_1} A_2^{i_2}} \frac{\Gamma(i_1) \Gamma(i_2)}{\Gamma(i_1+i_2)} \int_{h_1}^{h_2} \frac{t^{i_1+i_2-1} f(t)}{(\lambda + b_1 t)^{i_1+i_2}} \left\{1 - \frac{(b_1 - b_2)t}{\lambda + b_1 t}\right\}^{-i_2} dt \\ &= \frac{1}{A_1^{i_1} A_2^{i_2}} \frac{\Gamma(i_1) \Gamma(i_2)}{\Gamma(i_1+i_2)} \int_{h_1}^{h_2} \frac{t^{i_1+i_2-1} f(t)}{(\lambda + b_1 t)^{i_1} (\lambda + b_2 t)^{i_2}} dt \\ &= \frac{\Gamma(i_1) \Gamma(i_2)}{\Gamma(i_1+i_2)} \int_{h_1}^{h_2} \frac{t^{i_1+i_2-1} f(t) dt}{(A_1 \lambda + a_1 t)^{i_1} (A_2 \lambda + a_2 t)^{i_2}}. \end{aligned}$$

982. Next take the case of the triple integral

$$I_3 = \frac{1}{A_1^{i_1} A_2^{i_2} A_3^{i_3}} \iiint \frac{\xi_1^{i_1-1} \xi_2^{i_2-1} \xi_3^{i_3-1} f(\xi_1 + \xi_2 + \xi_3) d\xi_1 d\xi_2 d\xi_3}{(\lambda + b_1 \xi_1 + b_2 \xi_2 + b_3 \xi_3)^{i_1+i_2+i_3}}$$

Of these three quantities b_1, b_2, b_3 , let b_1 be that which is not less than either of the other two. Then

$$\lambda + b_1 \xi_1 + b_2 \xi_2 + b_3 \xi_3 = \{\lambda + b_1(\xi_1 + \xi_3) + b_2 \xi_2\} - (b_1 - b_3) \xi_3, = u - v, \text{ say,}$$

where $v = (b_1 - b_3) \xi_3$, and is $< u$ and positive. Let $i_1 + i_2 + i_3 = j_3$. Then

$$(\lambda + b_1 \xi_1 + b_2 \xi_2 + b_3 \xi_3)^{-j_3} = u^{-j_3} \left(1 - \frac{v}{u}\right)^{-j_3} = u^{-j_3} \sum_0^{\infty} K_r^{(j_3)} (b_1 - b_3)^r \left(\frac{\xi_3}{u}\right)^r,$$

a convergent binomial expansion.

$$\therefore I_3 = \sum_0^{\infty} \frac{(b_1 - b_3)^r}{A_1^{i_1} A_2^{i_2} A_3^{i_3}} \iiint \frac{\xi_1^{i_1-1} \xi_2^{i_2-1} \xi_3^{i_3-1} f\left(\sum_1^3 \xi_r\right)}{u^{j_3}} K_r^{(j_3)} \left(\frac{\xi_3}{u}\right)^r d\xi_1 d\xi_2 d\xi_3,$$

where u is, however, $\lambda + b_1(\xi_1 + \xi_2) + b_2 \xi_2$, and is not this time a function of the sum of the variables. Hence a further transformation is necessary.

We may write

$$u \equiv \lambda + b_1(\xi_1 + \xi_2) + b_2 \xi_2 = [\lambda + b_1(\xi_1 + \xi_2 + \xi_3)] - (b_1 - b_2) \xi_2 = U - V, \text{ say,}$$

where $V \equiv (b_1 - b_2) \xi_2$ is $< U$, and U is a function of $\xi_1 + \xi_2 + \xi_3$.

Also, writing $i_1 + i_2 + i_3 + r = j_3'$ where necessary to shorten

$$u^{-j_3'} = U^{-j_3'} \left(1 - \frac{V}{U}\right)^{-j_3'} = U^{-j_3'} \sum K_\rho^{(j_3')} (b_1 - b_2)^\rho \left(\frac{\xi_2}{U}\right)^\rho,$$

a convergent binomial expansion.

Hence

$$\begin{aligned} & \iiint \frac{\xi_1^{i_1-1} \xi_2^{i_2-1} \xi_3^{i_3+i_1+r-1} f(\sum \xi)}{u^{i_1+i_2+i_3+r}} d\xi_1 d\xi_2 d\xi_3 \\ &= \iiint \frac{\xi_1^{i_1-1} \xi_2^{i_2-1} \xi_3^{i_3+i_1+r-1}}{U^{j_3'}} f(\sum \xi) \sum_{\rho=0}^{\infty} K_\rho^{(j_3')} (b_1 - b_2)^\rho \left(\frac{\xi_2}{U}\right)^\rho d\xi_1 d\xi_2 d\xi_3 \\ &= \iiint \sum_{\rho=0}^{\infty} K_\rho^{(j_3')} (b_1 - b_2)^\rho \frac{\xi_1^{i_1-1} \xi_2^{i_2+\rho-1} \xi_3^{i_3+i_1+r-1}}{U^{j_3'+\rho}} f(\sum \xi) d\xi_1 d\xi_2 d\xi_3 \\ &= \int_{b_1}^{\infty} \sum_{\rho=0}^{\infty} K_\rho^{(j_3')} \frac{\Gamma(i_1) \Gamma(i_2+\rho) \Gamma(i_3+r)}{\Gamma(i_1+i_2+\rho+i_3+r)} (b_1 - b_2)^\rho \frac{t^{i_2+\rho-1} f(t)}{(\lambda + b_1 t)^{j_3'+\rho}} dt \end{aligned}$$

$$\begin{aligned}
&= \int_{h_1}^{h_2} \frac{\Gamma(i_1)\Gamma(i_2)\Gamma(i_3+r)}{\Gamma(i_1+i_2+i_3+r)} \frac{t^{i_3'-1}}{(\lambda+b_1t)^{i_3}} \sum_{\rho=0}^{\rho=\infty} K_{\rho}^{(i_2)} (b_1-b_2)^{\rho} \frac{t^{\rho}}{(\lambda+b_1t)^{\rho}} f(t) dt \\
&= \frac{\Gamma(i_1)\Gamma(i_2)\Gamma(i_3+r)}{\Gamma(i_1+i_2+i_3+r)} \int_{h_1}^{h_2} \frac{t^{i_3'-1}}{(\lambda+b_1t)^{i_3}} \left\{ 1 - \frac{(b_1-b_2)t}{\lambda+b_1t} \right\}^{-i_2} f(t) dt \\
&= \frac{\Gamma(i_1)\Gamma(i_2)\Gamma(i_3+r)}{\Gamma(i_1+i_2+i_3+r)} \int_{h_1}^{h_2} \frac{t^{i_3'-1} f(t) dt}{(\lambda+b_1t)^{i_1+i_2+r} (\lambda+b_2t)^{i_2}}; \\
\therefore I &= \sum_{r=0}^{r=\infty} \frac{(b_1-b_2)^r}{A_1^{i_1} A_2^{i_2} A_3^{i_3}} K_r^{(i_2)} \frac{\Gamma(i_1)\Gamma(i_2)\Gamma(i_3+r)}{\Gamma(i_1+i_2+i_3+r)} \int_{h_1}^{h_2} \frac{t^{i_3'-1} f(t) dt}{(\lambda+b_1t)^{i_1+i_2+r} (\lambda+b_2t)^{i_2}} \\
&= \frac{1}{A_1^{i_1} A_2^{i_2} A_3^{i_3}} \frac{\Gamma(i_1)\Gamma(i_2)\Gamma(i_3)}{\Gamma(i_1+i_2+i_3)} \int_{h_1}^{h_2} \frac{t^{i_3'-1} f(t)}{(\lambda+b_1t)^{i_1+i_2} (\lambda+b_2t)^{i_2}} \sum_{r=0}^{r=\infty} K_r^{(i_2)} \frac{(b_1-b_2)^r t^r}{(\lambda+b_1t)^r} dt \\
&= \frac{1}{A_1^{i_1} A_2^{i_2} A_3^{i_3}} \frac{\Gamma(i_1)\Gamma(i_2)\Gamma(i_3)}{\Gamma(i_1+i_2+i_3)} \int_{h_1}^{h_2} \frac{t^{i_3'-1} f(t)}{(\lambda+b_1t)^{i_1+i_2} (\lambda+b_2t)^{i_2}} \left\{ 1 - \frac{(b_1-b_2)t}{\lambda+b_1t} \right\}^{-i_2} dt \\
&= \frac{1}{A_1^{i_1} A_2^{i_2} A_3^{i_3}} \frac{\Gamma(i_1)\Gamma(i_2)\Gamma(i_3)}{\Gamma(i_1+i_2+i_3)} \int_{h_1}^{h_2} \frac{t^{i_3'-1} f(t)}{\prod_1^3 (\lambda+b_s t)^{i_s}} dt \\
&= \frac{\Gamma(i_1)\Gamma(i_2)\Gamma(i_3)}{\Gamma(i_1+i_2+i_3)} \int_{h_1}^{h_2} \frac{t^{i_3'-1} f(t) dt}{\prod_1^3 (A_s \lambda + a_s t)^{i_s}}.
\end{aligned}$$

983. Exactly the same process will hold for a multiple integral of higher order, so that in general we have

$$I_n = \frac{\Gamma(i_1)\Gamma(i_2)\dots\Gamma(i_n)}{\Gamma(i_1+i_2+\dots+i_n)} \int_{h_1}^{h_2} \frac{t^{i_1+i_2+\dots+i_n-1} f(t)}{\prod_1^n (A_s \lambda + a_s t)^{i_s}} dt.$$

984. Extension.

The result may obviously be extended to the integral

$$I_n = \iiint \dots \int \frac{x_1^{i_1-1} x_2^{i_2-1} \dots x_n^{i_n-1} f\left(\sum_1^n A_r x_r^{a_r}\right) dx_1 dx_2 \dots dx_n}{(\lambda + a_1 x_1^{a_1} + a_2 x_2^{a_2} + \dots + a_n x_n^{a_n})^k},$$

where $k = \frac{i_1}{a_1} + \frac{i_2}{a_2} + \dots + \frac{i_n}{a_n}$,

all the letters involved being positive quantities and the conditions of the limits being

$$h_1 < A_1 x_1^{a_1} + A_2 x_2^{a_2} + \dots + A_n x_n^{a_n} < h_2.$$

For putting $A_1 x_1^{a_1} = \xi_1$, $A_2 x_2^{a_2} = \xi_2$, etc., $\frac{a_1}{A_1} = b_1$, $\frac{a_2}{A_2} = b_2$, etc., we have

$$I_n = \frac{1}{\prod_1^n a_r A_r^{a_r}} \int \dots \int \frac{\xi_1^{i_1} \dots \xi_n^{i_n} f(\xi_1 + \dots + \xi_n)}{(\lambda + b_1 \xi_1 + \dots + b_n \xi_n)^k} \frac{d\xi_1 d\xi_2 \dots d\xi_n}{\xi_1 \xi_2 \dots \xi_n}$$

$$= \frac{1}{a_1 a_2 \dots a_n} \frac{\Gamma(i_1) \Gamma(i_2) \dots \Gamma(i_n)}{\Gamma(i_1 + i_2 + \dots + i_n)} \int_{h_1}^{h_2} \frac{t^{k-1} f(t) dt}{\prod_1^n (A_s \lambda + a_s t)^{i_s}}$$

Thus in all such cases the multiple integral is reduced to a single integration.

985. **Differentiation with regard to a parameter contained in the integrand.**

In a multiple integral

$$u = \int_{a_1}^{b_1} \int_{a_2}^{b_2} \dots \int_{a_n}^{b_n} \phi(x_1, x_2, \dots, x_n, c) dx_1 dx_2 \dots dx_n,$$

which contains a constant c , differentiation with regard to c may be effected by the same rule as for a single integral, provided that the limits of the several integrals are all independent of c . That is

$$\frac{\partial u}{\partial c} = \int_{a_1}^{b_1} \int_{a_2}^{b_2} \dots \int_{a_n}^{b_n} \frac{\partial \phi}{\partial c} dx_1 dx_2 \dots dx_n.$$

The proof of this is the same as in the case of a single integral.

986. **Liouville's Integral.**

Consider the case

$$I = \int_0^\infty \int_0^\infty \dots \int_0^\infty e^{-t} x_1^{\frac{1}{n}-1} x_2^{\frac{2}{n}-1} \dots x_{n-1}^{\frac{n-1}{n}-1} dx_1 dx_2 \dots dx_{n-1}, *$$

where $t \equiv x_1 + x_2 + \dots + x_{n-1} + \frac{\alpha^n}{x_1 x_2 \dots x_{n-1}}$,

an integral discussed by Liouville.

Differentiating with respect to α ,

$$\frac{dI}{d\alpha} = -n\alpha^{n-1} \int_0^\infty \dots \int_0^\infty e^{-t} x_1^{\frac{1}{n}-1} x_2^{\frac{2}{n}-1} \dots x_{n-1}^{\frac{n-1}{n}-1} \frac{dx_1 \dots dx_{n-1}}{x_1 x_2 \dots x_{n-1}}.$$

* Bertrand, *Calc. Intégral*, p. 476.

Now introduce another variable x_n defined by

$$x_1 x_2 \dots x_{n-1} x_n = a^n,$$

i.e. change to a system

$$x_1 = \frac{a^n}{x_2 x_3 \dots x_n}, \quad x_2 = x_2, \quad x_3 = x_3, \dots, x_{n-1} = x_{n-1}.$$

$$\text{Then } J = \frac{\partial(x_1, x_2, \dots, x_{n-1})}{\partial(x_2, x_3, \dots, x_n)} = (-1)^{n-1} \frac{a^n}{x_2 x_3 \dots x_n^2}.$$

Then $t \equiv x_1 + x_2 + \dots + x_{n-1} + \frac{a^n}{x_1 x_2 \dots x_{n-1}}$ is replaced by

$$x_2 + x_3 + \dots + x_n + \frac{a^n}{x_2 x_3 \dots x_n}, = t' \text{ say,}$$

and $x_1^{\frac{1}{n}-1} x_2^{\frac{2}{n}-1} \dots x_{n-1}^{\frac{n-1}{n}-1} \frac{dx_1 dx_2 \dots dx_{n-1}}{x_1 x_2 \dots x_{n-1}}$ is replaced by

$$J \left[\frac{a^n}{x_2 x_3 \dots x_n} \right]^{\frac{1}{n}-1} x_2^{\frac{2}{n}-1} x_3^{\frac{3}{n}-1} \dots x_{n-1}^{\frac{n-1}{n}-1} \frac{dx_2 dx_3 \dots dx_n}{a^n/x_n},$$

i.e. $(-1)^{n-1} a^{1-n} x_2^{\frac{1}{n}-1} x_3^{\frac{2}{n}-1} x_4^{\frac{3}{n}-1} \dots x_n^{\frac{n-1}{n}-1} dx_2 dx_3 \dots dx_n,$

and in the transformation of the multiple integral the sign is adjusted by a proper assignment of the limits.

Hence, as x_n is ∞ when x_1 is zero and *vice versa*, we have

$$\frac{dI}{da} = -n a^{n-1} \int_0^\infty \dots \int_0^\infty a^{1-n} e^{-t} x_2^{\frac{1}{n}-1} x_3^{\frac{2}{n}-1} \dots x_n^{\frac{n-1}{n}-1} dx_2 dx_3 \dots dx_n$$

$= -nI$ (for if a is increased I is decreased).

Hence $\frac{dI}{I} = -n da$, $\log I = -na + \text{const.}$, $I = Ce^{-na}$.

To find C , take the case $a=0$.

Then I becomes

$$\int_0^\infty \int_0^\infty \dots \int_0^\infty e^{-(x_1+x_2+\dots+x_{n-1})} x_1^{\frac{1}{n}-1} x_2^{\frac{2}{n}-1} \dots x_{n-1}^{\frac{n-1}{n}-1} dx_1 dx_2 \dots dx_{n-1},$$

and as the variables are independent and the limits constants, this may be written

$$\left[\int_0^\infty e^{-x_1} x_1^{\frac{1}{n}-1} dx_1 \right] \times \left[\int_0^\infty e^{-x_2} x_2^{\frac{2}{n}-1} dx_2 \right] \dots \times \left[\int_0^\infty e^{-x_{n-1}} x_{n-1}^{\frac{n-1}{n}-1} dx_{n-1} \right],$$

that is $\Gamma\left(\frac{1}{n}\right)\Gamma\left(\frac{2}{n}\right)\Gamma\left(\frac{3}{n}\right)\dots\Gamma\left(\frac{n-1}{n}\right)$ or $(2\pi)^{\frac{n-1}{2}}n^{-\frac{1}{2}}$.

Hence $C = (2\pi)^{\frac{n-1}{2}}n^{-\frac{1}{2}}$.

Hence the value of the integral is

$$I = (2\pi)^{\frac{n-1}{2}}n^{-\frac{1}{2}}e^{-na}.$$

987. Liouville's Method of proving Gauss' Theorem.

Consider the product

$$\Gamma(x)\Gamma\left(x+\frac{1}{n}\right)\Gamma\left(x+\frac{2}{n}\right)\dots\Gamma\left(x+\frac{n-1}{n}\right).$$

This may be written

$$\begin{aligned} &\int_0^\infty e^{-x_1}x_1^{x-1}dx_1 \times \int_0^\infty e^{-x_2}x_2^{x+\frac{1}{n}-1}dx_2 \dots \times \int_0^\infty e^{-x_n}x_n^{x+\frac{n-1}{n}-1}dx_n \\ &= \int_0^\infty \int_0^\infty \dots \int_0^\infty e^{-(x_1+x_2+\dots+x_n)}x_1^{x-1}x_2^{x+\frac{1}{n}-1} \dots x_n^{x+\frac{n-1}{n}-1} dx_1 dx_2 \dots dx_n. \end{aligned}$$

Now change the variables according to the scheme

$$x_1 = \frac{z^n}{x_2 x_3 \dots x_n}, \quad x_2 = x_2, \quad x_3 = x_3 \dots x_n = x_n.$$

Then $J = \frac{nz^{n-1}}{x_2 x_3 \dots x_n}$, and the integral may be written

$$\begin{aligned} &\int_0^\infty \int_0^\infty \dots \int_0^\infty e^{-\left(x_2+x_3+\dots+x_n+\frac{z^n}{x_2 x_3 \dots x_n}\right)} \frac{nz^{n-1}}{x_2 x_3 \dots x_n} \\ &\quad \times \left(\frac{z^n}{x_2 x_3 \dots x_n}\right)^{x-1} x_2^{x+\frac{1}{n}-1} x_3^{x+\frac{2}{n}-1} \dots x_n^{x+\frac{n-1}{n}-1} dz dx_2 dx_3 \dots dx_n, \end{aligned}$$

that is

$$\begin{aligned} &n \int_0^\infty \int_0^\infty \dots \int_0^\infty e^{-t} z^{nx-1} x_2^{\frac{1}{n}-1} x_3^{\frac{2}{n}-1} \dots x_n^{\frac{n-1}{n}-1} dz dx_2 dx_3 \dots dx_n \\ &= n \int_0^\infty (2\pi)^{\frac{n-1}{2}} n^{-\frac{1}{2}} e^{-nz} z^{nx-1} dz, \text{ by the preceding article,} \\ &= n^{\frac{1}{2}} (2\pi)^{\frac{n-1}{2}} \int_0^\infty e^{-nz} z^{nx-1} dz = n^{\frac{1}{2}-nx} (2\pi)^{\frac{n-1}{2}} \Gamma(nx), \end{aligned}$$

viz.

$$n^{nx} \Gamma(x)\Gamma\left(x+\frac{1}{n}\right)\dots\Gamma\left(x+\frac{n-1}{n}\right) = n^{\frac{1}{2}} (2\pi)^{\frac{n-1}{2}} \Gamma(nx),$$

which is Gauss' result.

PROBLEMS.

1. Find the mass of the triangular lamina bounded by the axes of coordinates and the line $x + y = a$ for a law of surface density $\mu x^p y^q$.

2. Find the mass of the tetrahedron bounded by the coordinate planes and the plane $a^{-1}x + b^{-1}y + c^{-1}z = 1$, the volume density being $\rho = \mu xyz$.

3. Find the centroid of the area in the first quadrant bounded by the lines $x + y = h_1$, $x + y = h_2$, for a law of surface density $\sigma = \mu x^p y^q$.

4. Find the centroid of the volume in the first octant bounded by the coordinate planes and the two planes

$$a^{-1}x + b^{-1}y + c^{-1}z = \delta_1, \quad a^{-1}x + b^{-1}y + c^{-1}z = \delta_2,$$

for the following laws of volume-density :

(i) $\rho = \mu(a^{-1}x + b^{-1}y + c^{-1}z)$, (ii) $\rho = \mu x^p y^q z^r$, (iii) $\rho = \mu(x^2 + y^2 + z^2)$.

5. Apply Dirichlet's theorem to find the mass of an octant of an ellipsoid in which the density at any point varies as the square of the product of the distances of the point from the principal sections of the ellipsoid.

6. Find the moment of inertia about the x -axis of the portion of the sphere $x^2 + y^2 + z^2 = a^2$, which lies in the positive octant, supposing the law of volume density to be $\rho = \mu xyz$. Obtain the corresponding result for an octant of the ellipsoid $x^2/a^2 + y^2/b^2 + z^2/c^2 = 1$.

7. Find the mass of the positive octant of a sphere of radius R , whose centre is the origin, for a law of volume density

$$\rho = \mu(a, b, c, f, g, h)(x, y, z)^2.$$

8. Find the mass, centroid and moments of inertia about the axes, of the positive octant of the ellipsoid $x^2/a^2 + y^2/b^2 + z^2/c^2 = 1$, for a law of volume density $\rho = \mu(x^2 + y^2 + z^2)$.

9. Show that the volume of the solid, the equation of whose surface is $a^{-4}x^4 + b^{-4}y^4 + c^{-4}z^4 = 1$, is $\frac{abc\sqrt{2}}{12\pi} \{\Gamma(\frac{1}{4})\}^4$.

10. A homogeneous solid is bounded by the surface

$$(x/a)^{\frac{3}{2}} + (y/b)^{\frac{3}{2}} + (z/c)^{\frac{3}{2}} = 1.$$

Show that the centroid of the portion of it in the positive octant is the point

$$\left(\frac{21a}{128}, \frac{21b}{128}, \frac{21c}{128}\right). \quad [\text{Oxf. II. PUb., 1901.}]$$

11. Find the position of the centroid of the portion of the solid bounded by

$$(x/a)^{2l} + (y/b)^{2m} + (z/c)^{2n} = 1,$$

which lies in the positive octant, the volume density being $\mu x^p y^q z^r$.

12. Show that $\iint x^{2l-1} y^{2m-1} dx dy$ for positive values of x and y , such that $x^2 + y^2 \leq c^2$, is

$$\frac{1}{4} c^{2l+2m} \frac{\Gamma(l) \Gamma(m)}{\Gamma(l+m+1)}. \quad [\text{I. C. S., 1893.}]$$

13. Obtain an expression for the value of

$$\iint x^{2l-1} y^{2m-1} f(ax^2 + by^2) dx dy$$

for all positive values of x and y , such that $ax^2 + by^2 \leq c^2$.

[I. C. S., 1893.]

14. Prove that the value of the volume integral

$$\iiint (\lambda x + \mu y + \nu z)^{2n} dx dy dz,$$

taken through the volume of the ellipsoid $x^2/a^2 + y^2/b^2 + z^2/c^2 = 1$, λ, μ, ν being constants and n a positive integer, is

$$4\pi abc (\lambda^2 a^2 + \mu^2 b^2 + \nu^2 c^2)^n / (2n+1)(2n+3).$$

[I. C. S., 1912.]

15. Find the value for positive values of x, y, z of

$$\iiint xyz \sin(x+y+z) dx dy dz$$

with condition $x+y+z \leq \frac{1}{2}\pi$.

[I. C. S., 1899.]

16. Prove that $\int_0^\infty \int_0^\infty \phi(x+y) x^\alpha y^\beta dx dy$

$$= \frac{\Gamma(\alpha+1) \Gamma(\beta+1)}{\Gamma(\alpha+\beta+2)} \int_0^\infty \phi(z) z^{\alpha+\beta+1} dz,$$

and extend the theorem to any number of variables. [COLL. γ , 1887.]

17. Prove that the area of the curve

$$(ax+by)^{2n} + (bx-ay)^{2n} = 1 \quad \text{is} \quad \left[\Gamma\left(\frac{1}{2n}\right) \right]^2 / n(a^2+b^2) \Gamma\left(\frac{1}{n}\right).$$

[COLL. γ , 1891.]

18. Find the volume enclosed by the surface

$$(x/a)^{2n} + (y/b)^{2n} + (z/c)^{2n} = 1,$$

where n is an integer.

[MATH. TRIP., PART II., 1919.]

Show that the distance of the centroid of the portion for which x is positive from the plane $x=0$ is

$$\bar{x} = \frac{3a}{4} \Gamma\left(\frac{1}{n}\right) \Gamma\left(\frac{3}{2n}\right) / \Gamma\left(\frac{2}{n}\right) \Gamma\left(\frac{1}{2n}\right).$$

19. Prove that
$$\iint \left(1 - \frac{x^2}{a^2} - \frac{y^2}{b^2}\right)^{\rho-1} f(ax + \beta y) dx dy$$

$$= \sqrt{\pi} ab \frac{\Gamma(\rho)}{\Gamma(\rho + \frac{1}{2})} \int_{-1}^1 (1 - t^2)^{\rho-\frac{1}{2}} f(kt) dt,$$

where $k = (a^2 a^2 + b^2 \beta^2)^{\frac{1}{2}}$, the double integral being taken for all values of x and y , such that

$$x^2/a^2 + y^2/b^2 < 1. \quad [\gamma, 1899.]$$

20. Show that, xyz being equal to a^3 ,

$$\int_0^\infty \int_0^\infty \int_0^\infty e^{-(x^4+y^4+z^4+u^4)} yz^2 dx dy dz = \frac{\pi^{\frac{3}{2}}}{32\sqrt{2}e^{4a^4}}.$$

[ST. JOHN'S, 1882.]

21. Show that

$$\iiint \frac{dx dy dz}{(\rho + \alpha x^2 + \beta y^2 + \gamma z^2)^{\frac{3}{2}}} = \frac{\pi}{6} \frac{abc}{\rho \sqrt{(\rho + a^2 \alpha)(\rho + b^2 \beta)(\rho + c^2 \gamma)}},$$

where x, y, z have all positive values such that

$$x^2/a^2 + y^2/b^2 + z^2/c^2 < 1. \quad [\text{COLLEGES } \gamma, 1891.]$$

22. Prove that

$$\iint \frac{(1-x-y)^{k-1} x^{m-1} y^{n-1}}{(\rho + \alpha x + \beta y)^{k+m+n+1}} dx dy$$

$$= \frac{\Gamma(k) \Gamma(m) \Gamma(n)}{\Gamma(k+m+n+1)} \left\{ \frac{k}{\rho} + \frac{m}{\rho + \alpha} + \frac{n}{\rho + \beta} \right\} \frac{1}{\rho^k (\rho + \alpha)^m (\rho + \beta)^n},$$

the integral extending to all positive values of x and y such that

$$x + y < 1. \quad [\text{COLLEGES } \gamma, 1891.]$$

23. Show that

$$\iint \dots \int \frac{x_1^{i_1-1} x_2^{i_2-1} \dots x_n^{i_n-1} f(x_1^{i_1} + x_2^{i_2} + \dots + x_n^{i_n})}{(\lambda + a_1 x_1^{i_1} + a_2 x_2^{i_2} + \dots + a_n x_n^{i_n})^n} dx_1 dx_2 \dots dx_n$$

$$= \frac{(-1)^{n-1}}{i_1 i_2 \dots i_n} \frac{1}{\Gamma(n)} \sum \frac{1}{(a_1 - a_2)(a_1 - a_3) \dots (a_1 - a_n)} \int_0^1 \frac{f(t)}{\lambda + a_1 t} dt,$$

the summation referring to a cyclical change of letters from a_1 to a_n , and the integration being effected for all positive values of the variables for which $x_1^{i_1} + x_2^{i_2} + \dots \geq 1$.

24. Prove that, n, r being positive whole numbers,

$$\int_0^\infty \int_0^\infty \dots \int_0^\infty \frac{dx_1 dx_2 \dots dx_{2n}}{\left(a^2 + \sum_1^{2n} x_r^2\right)^{\frac{2n+2r+1}{2}}} = \frac{\pi^n}{2a^{2r+1}} \frac{(n+r-1)!}{(2n+2r-1)!} \frac{(2r)!}{r!}.$$

[MATH. TRIP., 1870, WOLSTENHOLME.]

25. Prove that

$$\int_0^{x_1} \frac{dx_2}{(x_1 - x_2)^{\frac{n-1}{n}}} \int_0^{x_2} \frac{dx_3}{(x_2 - x_3)^{\frac{n-1}{n}}} \int_0^{x_3} \frac{dx_4}{(x_3 - x_4)^{\frac{n-1}{n}}} \cdots \int_0^{x_n} \frac{f'(\xi) d\xi}{(x_n - \xi)^{\frac{n-1}{n}}} \\ = \left\{ \Gamma\left(\frac{1}{n}\right) \right\}^n \{f(x_1) - f(0)\}.$$

(See Ex. 30, Ch. XXIV.)

[MATH. TRIPOS, 1875.]

26. Prove that

$$\int_0^\infty \int_0^\infty e^{-(x_1 + x_2 + \frac{a^3}{x_1 x_2})} x_1^{\frac{1}{3}} x_2^{\frac{2}{3}} \frac{dx_1}{x_1} \frac{dx_2}{x_2} = e^{-3a} \Gamma\left(\frac{1}{3}\right) \Gamma\left(\frac{2}{3}\right).$$

[LIOUVILLE.]

27. If n be a positive integer, show that for an integration conducted over a triangle of area Δ in the x - y plane

$$\iint y^n dx dy = \Delta H_n,$$

where H_n is the arithmetic mean of the homogeneous products of the ordinates of the corners, and find the corresponding result for any plane polygon.

[ROUTH, *Rigid Dyn.*, p. 425.]

28. Show that if the integration be conducted for all positive values of x_1, x_2, x_3, x_4 such that $x_1 + x_2 \geq 1$ and $x_3 + x_4 \geq 1$, then

$$\iiint \int x_1^{i_1-1} x_2^{i_2-1} x_3^{i_3-1} x_4^{i_4-1} dx_1 dx_2 dx_3 dx_4 \\ = \Gamma(i_1) \Gamma(i_2) \Gamma(i_3) \Gamma(i_4) / \Gamma(i_1 + i_2 + 1) \Gamma(i_3 + i_4 + 1).$$

29. If $t \equiv x_1^n + x_2^n + \dots + x_n^n$ and $x_1 x_2 \dots x_n = a^n$, evaluate the integral

$$\int_0^\infty \int_0^\infty \dots \int_0^\infty e^{-t} x_1^1 x_2^2 x_3^3 \dots x_{n-1}^{n-1} \frac{dx_1}{x_1} \frac{dx_2}{x_2} \dots \frac{dx_{n-1}}{x_{n-1}}.$$

30. If $t \equiv x_1^{\frac{n}{1}} + x_2^{\frac{n}{2}} + x_3^{\frac{n}{3}} + \dots + x_n^{\frac{n}{n}}$ and $x_1^{\frac{1}{1}} x_2^{\frac{1}{2}} x_3^{\frac{1}{3}} \dots x_n^{\frac{1}{n}} = a$, show that

$$\int_0^\infty \int_0^\infty \dots \int_0^\infty e^{-t} dx_1 dx_2 \dots dx_{n-1} = \frac{n!}{n^{\frac{n}{2}+1}} \frac{(2\pi)^{\frac{n-1}{2}}}{e^{na}}.$$

CHAPTER XXVI.

DEFINITE INTEGRALS (I).

988. It has been stated that when $\int \phi(x) dx$ can be integrated, and the result of the indefinite integration is $\psi(x)$, then the quantity $\psi(b) - \psi(a)$ is denoted by $\int_a^b \phi(x) dx$; and it has been shown that $\psi(b) - \psi(a)$ is the result of obtaining the limit when h is indefinitely small of

$$h[\phi(a) + \phi(a+h) + \phi(a+2h) + \dots + \phi\{(a+(n-1)h)\}],$$

where $b = a + nh$; and the process of obtaining the value of $\int_a^b \phi(x) dx$ has been termed a Definite Integration.

We have performed this definite integration in many cases, first of all obtaining the indefinite integral by the rules of the early chapters and so finding $\psi(x)$, and then inserting the values of the limits to obtain the expression $\psi(b) - \psi(a)$; and in doing this our chief attention has been centred upon the discovery of the function $\psi(x)$, whose differential coefficient is $\phi(x)$; *i.e.* upon the reversal of the general problem of differentiation.

It will have been gathered from the last two chapters that the value of the definite integral between certain specific limits can be obtained in many instances by some artifice, even in cases where it is not possible to perform the indefinite integration; *i.e.* that it is possible sometimes to arrive at the value of $\psi(b) - \psi(a)$ without finding the form of $\psi(x)$ at all. Such a case was that of $\int_0^{\infty} e^{-x^2} dx$ discussed in Art. 864, where the

indefinite integration of e^{-x^2} could not be expressed in finite terms, but for which the definite integral from 0 to ∞ was discovered to be $\frac{\sqrt{\pi}}{2}$. It is to this class of definite integral in particular that we now turn our attention, and it is to this class—viz. where the integrand does not admit of indefinite integration in finite terms—that the term Definite Integral is by convention mainly confined.

A very large number of such results have been found. A collection of such definite integrals was made by Bierens de Haan, and published under the title *Tables d'Intégrales Définies* (Amsterdam).

989. The artifices employed are numerous and of great variety and ingenuity. It is impossible to give an exhaustive list, but some of the more common devices are as follow :

(a) The use of a reduction formula connecting the integral sought with one or more other integrals already found, or more capable of investigation, or with some multiple of itself.

(b) The integral $\int_a^d \phi(x) dx$ may be regarded as

$$\left(\int_a^b + \int_b^c + \int_c^d \right) \phi(x) dx,$$

in which the notation will explain itself. That is, the summation from a to d may be broken up into sections, (a to b), (b to c), etc., and each part may be considered separately.

(c) The expansion of the function to be integrated, or of some factor of it in a convergent series, or in partial fractions, with the integration of the several terms and a final summation of the results.

(d) Change of the variable with the corresponding change in the limits.

(e) Differentiation or integration of a known integral with regard to some constant which it may contain.

(f) A factor of the function to be integrated may itself be the result of a known integration between certain

constant limits. Upon substituting this integral for the factor a double integral may be formed, and a change in the order of integration or a transformation to a system of new variables may succeed in obtaining the value of the integral under consideration.

- (g) Investigation of the integral from the original summation definition of an integral.
- (h) The application of some general theorem such as those already considered in the Eulerian integrals or Dirichlet's integrals, or the theorems of Frullani, Cauchy, Kummer, Poisson or Abel, which will be severally discussed in their proper places.
- (i) Several of these methods may be combined.
- (j) The application of Cauchy's theorem in integrating round some closed contour. Contour integration will be reserved for a special chapter.
- (k) The substitution of a complex quantity for a constant involved in a known integral, and in its result, followed by equating real and unreal parts, frequently suggests new integrals; but the method requires great caution if it is to be regarded as rigidly establishing the values of the resulting definite integrals without further investigation. But it frequently happens that such suggested results can be established by other means.

These are the principal devices used. There are many others applicable to particular forms. A general statement such as the above is necessarily vague on account of its generality. The student should examine the mode of procedure in the numerous cases which we shall have to discuss, and note for himself the method adopted.

990. Illustrations of Definite Integrals deduced by Change of the Variable.

$$1. I = \int_0^{\frac{\pi}{2}} \log \sin \theta \, d\theta \quad [\text{Euler, } \textit{Actu Petrop.}, \text{ vol. i., p. 2}].$$

$$\text{Writing } \theta = \frac{\pi}{2} - \phi, \quad I = - \int_{\frac{\pi}{2}}^0 \log \cos \phi \, d\phi = \int_0^{\frac{\pi}{2}} \log \cos \theta \, d\theta.$$

Adding, we have

$$\begin{aligned}
 2I &= \int_0^{\frac{\pi}{2}} (\log \sin \theta + \log \cos \theta) d\theta = \int_0^{\frac{\pi}{2}} (\log \sin 2\theta - \log 2) d\theta \\
 &= \int_0^{\frac{\pi}{2}} \log \sin 2\theta d\theta - \frac{\pi}{2} \log 2, \text{ and writing } \chi \text{ for } 2\theta, \\
 \int_0^{\frac{\pi}{2}} \log \sin 2\theta d\theta &= \frac{1}{2} \int_0^{\pi} \log \sin \chi d\chi = \int_0^{\frac{\pi}{2}} \log \sin \theta d\theta = I; \\
 \therefore 2I &= I - \frac{\pi}{2} \log 2, \text{ giving } I = \frac{\pi}{2} \log \frac{1}{2}.
 \end{aligned}$$

Hence $\int_0^{\frac{\pi}{2}} \log \sin \theta d\theta = \int_0^{\frac{\pi}{2}} \log \cos \theta d\theta = \frac{\pi}{2} \log \frac{1}{2}$(1)

It also follows that

$$\int_0^{\frac{\pi}{2}} (\log \sin \theta - \log \cos \theta) d\theta = 0, \text{ i.e. } \int_0^{\frac{\pi}{2}} \log \tan \theta d\theta = 0, \dots(2)$$

and $\int_0^{\frac{\pi}{2}} \log \sec \theta d\theta = \int_0^{\frac{\pi}{2}} \log \operatorname{cosec} \theta d\theta = \frac{\pi}{2} \log 2$(3)

If we write $\sin \theta = x$ we have another form of the same integral, viz.

$$\int_0^1 \frac{\log x}{\sqrt{1-x^2}} dx = \frac{\pi}{2} \log \frac{1}{2}; \dots\dots\dots(4)$$

or again, putting $x = e^{-y}$,

$$\int_0^{\infty} \frac{y}{\sqrt{e^{2y}-1}} dy = \frac{\pi}{2} \log 2 \text{ or } \int_0^{\infty} \frac{xe^{-\frac{1}{2}x}}{\sqrt{\sinh x}} dx = \frac{\pi}{\sqrt{2}} \log 2; \dots\dots\dots(5)$$

or again, integrating (1) by parts,

$$\begin{aligned}
 \left[\theta \log \sin \theta \right]_0^{\frac{\pi}{2}} - \int_0^{\frac{\pi}{2}} \theta \cot \theta d\theta &= \frac{\pi}{2} \log \frac{1}{2}; \\
 \therefore \int_0^{\frac{\pi}{2}} \theta \cot \theta d\theta &= \frac{\pi}{2} \log 2; \dots\dots\dots(6)
 \end{aligned}$$

or integrating again,

$$\begin{aligned}
 \left[\frac{\theta^2}{2} \cot \theta \right]_0^{\frac{\pi}{2}} + \int_0^{\frac{\pi}{2}} \frac{\theta^2}{2} \operatorname{cosec}^2 \theta d\theta &= \frac{\pi}{2} \log 2; \\
 \therefore \int_0^{\frac{\pi}{2}} \frac{\theta^2}{\sin^2 \theta} d\theta &= \pi \log 2; \dots\dots\dots(7)
 \end{aligned}$$

or, which is the same thing, putting $\cot \theta = x$,

$$\int_0^{\infty} (\cot^{-1} x)^2 dx = \pi \log 2 \dots\dots\dots(8)$$

2. $I = \int_0^\pi \frac{\theta \sin \theta d\theta}{a + b \cos^2 \theta}$, a and b both positive (Poisson, *Journal de l'École Polytechnique*, xvii., p. 624, case where $a = b = 1$).

Writing $\pi - \phi$ for θ ,

$$\begin{aligned} I &= - \int_\pi^0 \frac{(\pi - \phi) \sin \phi}{a + b \cos^2 \phi} d\phi = \pi \int_0^\pi \frac{\sin \phi}{a + b \cos^2 \phi} d\phi - I; \\ \therefore 2I &= \frac{\pi}{b} \int_0^\pi \frac{\sin \phi d\phi}{\frac{a}{b} + \cos^2 \phi} = \frac{\pi}{b} \left[-\sqrt{\frac{b}{a}} \tan^{-1} \sqrt{\frac{b}{a}} \cos \phi \right]_0^\pi \\ &= \frac{\pi}{\sqrt{ab}} 2 \tan^{-1} \sqrt{\frac{b}{a}}; \quad \therefore I = \frac{\pi}{\sqrt{ab}} \tan^{-1} \sqrt{\frac{b}{a}}. \end{aligned}$$

The case $a = b = 1$ gives $\int_0^\pi \frac{\theta \sin \theta}{1 + \cos^2 \theta} d\theta = \pi \tan^{-1} 1 = \frac{\pi^2}{4}$.

991. In illustration of the method of expansion we may, for the same example in the case $a > b$, expand $\left(1 + \frac{b}{a} \cos^2 \theta\right)^{-1}$. Then

$$I = \frac{1}{a} \int_0^\pi \left[\theta \sin \theta - \frac{b}{a} \theta \sin \theta \cos^2 \theta + \frac{b^2}{a^2} \theta \sin \theta \cos^4 \theta - \dots \right] d\theta,$$

a convergent expansion if $b < a$.

But

$$\begin{aligned} \int_0^\pi \theta \sin \theta \cos^{2n} \theta d\theta &= \left[-\frac{\theta \cos^{2n+1} \theta}{2n+1} \right]_0^\pi + \frac{1}{2n+1} \int_0^\pi \cos^{2n+1} \theta d\theta = \frac{\pi}{2n+1} + 0; \\ \therefore I &= \frac{\pi}{a} \left[\frac{1}{1} - \frac{1}{3} \frac{b}{a} + \frac{1}{5} \frac{b^2}{a^2} - \dots \right] \\ &= \frac{\pi}{\sqrt{ab}} \tan^{-1} \sqrt{\frac{b}{a}} \text{ by Gregory's Series.} \end{aligned}$$

If, however, $a < b$ the expansion used would be divergent, and the method would fail.

992. Illustrations of a Combination of Methods.

Let $I = \int_0^\pi x \sin^n x dx$. Write $x = \pi - y$.

$$I = \int_0^\pi (\pi - y) \sin^n y dy = \pi \int_0^\pi \sin^n y dy - I;$$

$$\therefore I = \frac{\pi}{2} \int_0^\pi \sin^n x dx = \pi \int_0^{\frac{\pi}{2}} \sin^n x dx,$$

and the result can be written down.

This integral is useful, in cases where $F(x)$ is capable of expansion in powers of $\sin x$, for finding $\int_0^\pi x F(x) dx$.

$$\begin{aligned}
 \text{Ex. 1. } I &= \int_0^{\pi} \frac{x}{\sin x} \log(1 + n \sin x) dx \quad (n < 1) \\
 &= \int_0^{\pi} x \left[n - \frac{n^2}{2} \sin x + \frac{n^3}{3} \sin^2 x - \dots \right] dx \\
 &= \frac{n\pi^2}{2} - \frac{n^2}{2} \pi + \frac{n^3}{3} \pi \frac{1}{2} - \frac{n^4}{4} \pi \frac{2}{3} + \frac{n^5}{5} \pi \frac{3}{4} \frac{1}{2} - \frac{n^6}{6} \pi \frac{4}{5} \frac{2}{3} + \dots \\
 &= \frac{\pi^2}{2} \left(n + \frac{1}{2} \frac{n^3}{3} + \frac{1 \cdot 3}{2 \cdot 4} \frac{n^5}{5} + \dots \right) - \pi \left[\frac{n^2}{2} + \frac{2}{3} \frac{n^4}{4} + \frac{2 \cdot 4}{3 \cdot 5} \frac{n^6}{6} \dots \right] \\
 &= \frac{\pi^2}{2} \sin^{-1} n - \pi \left(\frac{\sin^{-1} n}{2} \right)^2. \quad (\text{See } \textit{Diff. Calc.}, \text{ p. 90, Ex. 3, Part 3.})
 \end{aligned}$$

$$\begin{aligned}
 \text{Ex. 2. } I &= \int_0^{\pi} \frac{x dx}{1 + \cos a \sin x} \\
 &= \int_0^{\pi} x (1 - \cos a \sin x + \cos^2 a \sin^2 x - \dots) dx \\
 &= \pi \left[\frac{\pi}{2} - \cos a + \cos^2 a \frac{1}{2} \frac{\pi}{2} - \cos^3 a \frac{2}{3} + \cos^4 a \frac{3}{4} \frac{1}{2} \frac{\pi}{2} - \cos^5 a \frac{4}{5} \frac{2}{3} + \dots \right] \\
 &= -\pi \left[\cos a + \frac{2}{3} \cos^3 a + \frac{2 \cdot 4}{3 \cdot 5} \cos^5 a + \dots \right] \\
 &\quad + \frac{\pi^2}{2} \left[1 + \frac{1}{2} \cos^2 a + \frac{1 \cdot 3}{2 \cdot 4} \cos^4 a + \frac{1 \cdot 3 \cdot 5}{2 \cdot 4 \cdot 6} \cos^6 a + \dots \right] \\
 &= -\pi \frac{\sin^{-1} \cos a}{\sqrt{1 - \cos^2 a}} + \frac{\pi^2}{2} (1 - \cos^2 a)^{-\frac{1}{2}} \quad (\text{See } \textit{Diff. Calc.}, \text{ Ex. 3, p. 85.}) \\
 &= -\pi \frac{\frac{\pi}{2} - a}{\sin a} + \frac{\pi^2}{2 \sin a} = \pi \frac{a}{\sin a} \quad (\text{WOLSTENHOLME.})
 \end{aligned}$$

This integral might be treated thus :

Write $\pi - x$ for x .

$$\begin{aligned}
 I &= \int_0^{\pi} \frac{(\pi - x) dx}{1 + \cos a \sin x} = \pi \int_0^{\pi} \frac{dx}{1 + \cos a \sin x} - I; \\
 \therefore I &= \frac{\pi}{2} \int_0^{\pi} \frac{dx}{1 + \cos a \sin x} = \frac{\pi}{2} \int_0^{\pi} \frac{\sec^2 \frac{x}{2} dx}{1 + 2 \cos a \tan \frac{x}{2} + \tan^2 \frac{x}{2}} \\
 &= \frac{\pi}{\sin a} \left\{ \tan^{-1} \left(\frac{\tan \frac{x}{2} + \cos a}{\sin a} \right) \right\}_0^{\pi} = \frac{\pi}{\sin a} \left[\frac{\pi}{2} - \tan^{-1} \cot a \right] \\
 &= \frac{\pi}{\sin a} \cdot \tan^{-1}(\tan a) = \pi \frac{a}{\sin a}.
 \end{aligned}$$

EXAMPLES.

1. Prove that $\int_{\frac{1}{2}}^{\frac{1}{2}} \sqrt{x^2 + 1} dx = \frac{1}{2} \frac{8}{8} \frac{5}{8} + \frac{1}{2} \log \frac{5}{2}$. [ST. JOHN'S, 1884.]

2. Prove that $\int_0^{\frac{\pi}{4}} \sec^3 \theta d\theta = \frac{1}{\sqrt{2}} + \frac{1}{2} \log(\sqrt{2} + 1)$.
[MATH. TRIPOS, 1889.]

3. Prove that $\int_0^{\infty} \phi(x) dx = \int_0^1 \left[\phi(x) + \frac{1}{x^2} \phi\left(\frac{1}{x}\right) \right] dx$.
[ST. JOHN'S, 1882 and 1887.]

4. Show that, n being a positive integer,

$$(n-1) \int \frac{\log x}{(1+x)^n} dx = \frac{1}{1+x} + \frac{1}{2(1+x)^2} + \frac{1}{3(1+x)^3} + \dots$$

$$+ \frac{1}{n-2} \frac{1}{(1+x)^{n-2}} + \log \frac{x}{1+x} - \frac{\log x}{(1+x)^{n-1}},$$

and that

$$(a) \int_0^{\infty} \frac{\log x}{(1+x)^n} dx = -\frac{1}{n-1} \left(\frac{1}{1} + \frac{1}{2} + \frac{1}{3} + \dots + \frac{1}{n-2} \right).$$

$$(b) \int_0^{\infty} \frac{\log x}{(1+x)^4} dx = -\frac{1}{2}. \quad \text{[ST. JOHN'S, 1882.]}$$

$$(c) \int_0^{\infty} \frac{1-3x}{(1+x)^5} (\log x)^2 dx = 1. \quad \text{[ST. JOHN'S, 1882.]}$$

5. Prove that

$$\int_0^{\frac{\pi}{2}} (\sin \theta - \cos \theta) \log(\sin \theta + \cos \theta) d\theta = 0. \quad \text{[ST. JOHN'S, 1884.]}$$

6. Prove that

$$\int_0^{\pi} \theta^3 \log \sin \theta d\theta = \frac{3\pi}{2} \int_0^{\pi} \theta^2 \log(\sqrt{2} \sin \theta) d\theta. \quad \text{[ST. JOHN'S, 1884.]}$$

7. Prove that

$$(i) \int_{-\infty}^{\infty} \frac{dx}{(x^2 \pm ax + a^2)(x^2 \pm bx + b^2)} = \frac{2\pi}{\sqrt{3}} \frac{a+b}{ab(a^2+ab+b^2)}.$$

$$(ii) \int_{-\infty}^{\infty} \frac{dx}{(x^2 \pm ax + a^2)(x^2 \mp bx + b^2)} = \frac{2\pi}{\sqrt{3}} \frac{1}{ab(a+b)}. \quad \text{[COLLEGES \gamma, 1891.]}$$

8. Show that
$$\int_0^{\frac{\pi}{2}} \frac{x}{\tan x} dx = \frac{\pi}{2} \log 2. \quad [\text{OXFORD II. P., 1888.}]$$

9. Show that

$$\int_0^{\infty} \left(\frac{\tan^{-1} x}{x} \right)^3 dx = \frac{1}{2} \pi (3 \log_e 2 - \frac{1}{4} \pi^2). \quad [\text{MATH. TRIPOS, 1887.}]$$

10. Show that

$$\int_0^a \sinh px \sin \frac{k\pi x}{a} dx = - \frac{ka\pi \sinh(pa)(-1)^k}{p^2 a^2 + k^2 \pi^2}. \quad [\text{CLARE, CAIUS AND KING'S, 1885.}]$$

11. Prove that

$$(1) \int_0^{\frac{\pi}{4}} \frac{\sin^2 x dx}{e^{2mx} (\cos x - m \sin x)^2} = \frac{1}{2m(1+m^2)} \left[\frac{1+m}{1-m} e^{-m\frac{\pi}{2}} - 1 \right].$$

$$(2) \int_0^{\frac{\pi}{4}} \frac{\cos^2 x dx}{e^{2mx} (\sin x + m \cos x)^2} = \frac{1}{2m(1+m^2)} \left[\frac{1-m}{1+m} e^{-m\frac{\pi}{2}} + 1 \right].$$

[ST. JOHN'S, 1886.]

12. Prove that
$$\int_0^{\pi} \frac{x}{1 + \sin^2 x} dx = \frac{\pi^2}{2\sqrt{2}}. \quad [\text{OXF. II. P., 1885.}]$$

13. Show that

$$\int_{-\frac{\pi}{4}}^{\frac{\pi}{4}} \log(\sin x + \cos x) dx = -\frac{\pi}{4} \log 2. \quad [\text{COLLEGES, 1886.}]$$

14. Show that
$$\int_0^{\infty} \frac{dx}{e^x \sqrt{\sinh 2x}} = \frac{\pi}{2\sqrt{2}}. \quad [\text{ST. JOHN'S, 1890.}]$$

15. Prove that

$$\int_{1-b}^b x f\{x(1-x)\} dx = \frac{1}{2} \int_{1-b}^b f\{x(1-x)\} dx.$$

[COLLEGES, 1882.]

16. Prove that
$$\int_0^{\frac{\pi}{2}} \sin^n 2\theta \log \tan \theta d\theta = 0,$$
 where n is any positive integer
[COLLEGES, 1882.]

17. Prove that

$$\int_b^a \frac{x^{n-1} \{(n-2)x^2 + (n-1)(a+b)x + nab\}}{(x+a)^2(x+b)^2} dx = \frac{a^{n-1} - b^{n-1}}{2(a+b)}.$$

[ST. JOHN'S, 1890.]

18. Establish the result

$$\int_0^{\pi} \frac{x^2 \sin 2x \sin \left(\frac{\pi}{2} \cos x \right)}{2x - \pi} dx = \frac{8}{\pi}.$$

[MATH. TRIPOS, 1882.]

19. Prove that

$$\int_0^{\frac{\pi}{2}} \left\{ \left(\frac{3}{x^2} - 1 \right) \sin x - \frac{3}{x} \cos x \right\}^2 dx = \frac{\pi}{4} - \frac{24}{\pi^3}. \quad [\text{COLLEGES } \beta, 1890.]$$

20. Prove that $\int_0^{\frac{\pi}{2}} \log(1 + \tan \theta) d\theta = \frac{\pi \log 2}{8}$. [TRINITY, 1885.]

21. If α be any angle between $\frac{\pi}{2}$ and $-\frac{\pi}{2}$, show that

$$\int_0^{\alpha} \log(1 + \tan \alpha \tan x) dx = \alpha \log \sec \alpha. \quad [\epsilon, 1884.]$$

22. Prove that, in general,

$$\int_{\beta}^{\alpha} F \left\{ \log_e \frac{x\sqrt{e}}{x+1} \cdot \log_e \frac{x}{(x+1)\sqrt{e}} \right\} \frac{2x+1}{x^2(x+1)^2} dx = 0,$$

where

$$\alpha = \frac{1}{\sqrt{e}-1}, \quad \beta = \frac{\sqrt{e}}{1-\sqrt{e}},$$

and F is any function.

[ϵ , 1881.]

23. Prove that

$$\int_0^{\frac{\pi}{2}} \log(\sin^2 \theta + k^2 \cos^2 \theta) d\theta = \pi \log \frac{1+k}{2} \quad (k \geq 0).$$

[Oxf. I. P., 1918.]

24. Prove that

$$\int_{-\infty}^{\infty} f\left(a^2x^2 + \frac{b^2}{x^2}\right) dx = \frac{1}{a} \int_{-\infty}^{\infty} f(x^2 + 2ab) dx.$$

993. Integrals of form $\int_0^{\infty} \frac{\sin^m rx}{x^n} dx$, ($m < n$), etc.

Consider the integral $I = \int_0^{\infty} \frac{\sin rx}{x} dx$, r being a real constant.

If we write $rx = y$, $I = \int_0^{\infty} \frac{\sin y}{y} dy = \int_0^{\infty} \frac{\sin x}{x} dx$, which is independent of r . But it is obvious upon changing the sign of r in the original integral that the sign of the result must be changed, for all elements of the integrand $\frac{\sin rx}{x}$ change sign.

Further, when $r=0$ the value of I is zero. Here then is a curious discontinuity which must be examined.

The integral is of great importance in the theory of definite integrals, and we propose to illustrate by means of it several methods of procedure as mentioned above.

994. METHOD I. By breaking up the Integration into Sections.

$$\begin{aligned} \text{We have } I \equiv \int_0^{\infty} \frac{\sin x}{x} dx = & \left[\left(\int_0^{\pi} + \int_{\pi}^{2\pi} \right) + \left(\int_{2\pi}^{3\pi} + \int_{3\pi}^{4\pi} \right) + \dots \right. \\ & \left. + \left(\int_{(2n-2)\pi}^{(2n-1)\pi} + \int_{(2n-1)\pi}^{2n\pi} \right) + \dots \right] \frac{\sin x}{x} dx, \end{aligned}$$

a notation which will need no explanation.

In these pairs of successive integrals put $x = \pi - y$, $\pi + y$; $3\pi - y$, $3\pi + y$; ... $(2n-1)\pi - y$, $(2n-1)\pi + y$; etc.

Then

$$\int_{(2n-2)\pi}^{(2n-1)\pi} \frac{\sin x}{x} dx = - \int_{\pi(2n-1)}^0 \frac{\sin y}{\pi - y} dy = \int_0^{\pi} \frac{\sin y}{(2n-1)\pi - y} dy,$$

$$\text{and } \int_{(2n-1)\pi}^{2n\pi} \frac{\sin x}{x} dx = - \int_0^{\pi} \frac{\sin y}{(2n-1)\pi + y} dy.$$

Thus, putting $n = 1, 2, 3 \dots$ successively, the integral becomes

$$\begin{aligned} I &= \int_0^{\pi} \sin y \left[\frac{1}{\pi - y} - \frac{1}{\pi + y} + \frac{1}{3\pi - y} - \frac{1}{3\pi + y} + \dots \right] dy \\ &= \int_0^{\pi} \sin y \frac{1}{2} \tan \frac{y}{2} dy \quad (\text{Hobson, Trigonometry, p. 335.}) \\ &= \int_0^{\pi} \sin^2 \frac{y}{2} dy = \frac{1}{2} \int_0^{\pi} (1 - \cos y) dy = \frac{\pi}{2}. \end{aligned}$$

995. If we put $x = -y$ it is clear that

$$\int_0^{\infty} \frac{\sin x}{x} dx = - \int_0^{-\infty} \frac{\sin y}{y} dy = \int_{-\infty}^0 \frac{\sin y}{y} dy = \int_{-\infty}^0 \frac{\sin x}{x} dx.$$

Hence

$$\int_{-\infty}^{\infty} \frac{\sin x}{x} dx = \left(\int_{-\infty}^0 + \int_0^{\infty} \right) \frac{\sin x}{x} dx = 2 \int_0^{\infty} \frac{\sin x}{x} dx = 2 \cdot \frac{\pi}{2} = \pi.$$

996. If r be positive we have, by putting $rx = y$,

$$\int_0^{\infty} \frac{\sin rx}{x} dx = \int_0^{\infty} \frac{\sin y}{y} dy = \frac{\pi}{2}.$$

If r be negative we have, by putting $rx = y$,

$$\begin{aligned} \int_0^{\infty} \frac{\sin rx}{x} dx &= \int_0^{-\infty} \frac{\sin y}{y} dy = - \int_{-\infty}^0 \frac{\sin y}{y} dy \\ &= - \int_0^{\infty} \frac{\sin y}{y} dy = - \frac{\pi}{2}. \end{aligned}$$

If r be zero the integrand is zero, and

$$\int_0^{\infty} \frac{\sin rx}{x} dx = 0.$$

997. If the integrand be regarded as a function of r the discontinuity may be exhibited geometrically by tracing the graph of $y = \int_0^{\infty} \frac{\sin x\theta}{\theta} d\theta$, which will consist of

the straight line $y = -\frac{\pi}{2}$, from $x = -\infty$ to $x = 0$;

the point $x = 0, y = 0$, when $x = 0$;

the straight line $y = \frac{\pi}{2}$, from $x = 0$ to $x = \infty$;

and is shown in Fig. 323.

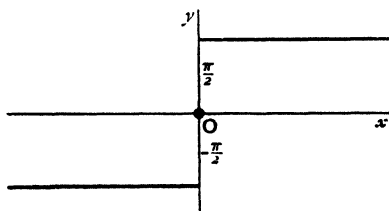

Fig. 323.

998. The graph of the *integrand*, viz. $\frac{\sin x}{x}$, is shown in Fig. 324.

The integral $\int_0^{\infty} \frac{\sin x}{x} dx$ is the difference of the areas between the x -axis and the successive portions of the curve which lie above the x -axis

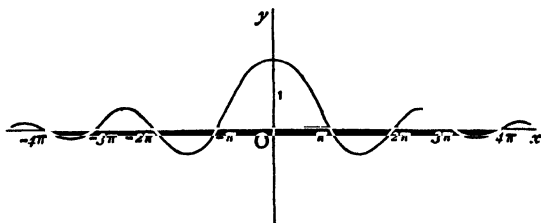

Fig. 324.

in the first quadrant and below it in the fourth quadrant. The successive maxima rapidly diminish. The positions of these maxima are given by the equation $\tan x = x$, and can be determined graphically as the intersections of the graphs of $y = \tan x$ and $y = x$. They occur in each case a little

earlier than midway between two successive cuts of the curve $y = \frac{\sin x}{x}$ by the x -axis, but rapidly approximate to the midway as x increases.

999. METHOD II. **A Further Illustration of breaking up the Integration into Sections.**

Since the y -axis is an axis of symmetry for the graph of $\frac{\sin x}{x}$ we may take

$$I \equiv \int_0^{\infty} \frac{\sin x}{x} dx = \frac{1}{2} \int_{-\infty}^{\infty} \frac{\sin x}{x} dx;$$

$$\therefore 2I = \left(\int_0^{\pi} + \int_{\pi}^{2\pi} + \int_{2\pi}^{3\pi} + \int_{3\pi}^{4\pi} + \dots \right) \left(\frac{\sin x}{x} dx \right).$$

$$\left(+ \int_{-\pi}^0 + \int_{-2\pi}^{-\pi} + \int_{-3\pi}^{-2\pi} + \dots \right)$$

In the integrals in the first row put

$$x = y, \quad \pi + y, \quad 2\pi + y, \quad 3\pi + y, \text{ etc.},$$

and in the second row

$$x = -\pi + y, \quad -2\pi + y, \quad -3\pi + y, \text{ etc.}$$

Then

$$2I = \int_0^{\pi} \sin y \left[\frac{1}{y} - \frac{1}{\pi + y} + \frac{1}{2\pi + y} - \frac{1}{3\pi + y} + \dots \right. \\ \left. - \frac{1}{-\pi + y} + \frac{1}{-2\pi + y} - \frac{1}{-3\pi + y} + \dots \right] dy$$

$$= \int_0^{\pi} \sin y \left[\frac{1}{y} - \frac{1}{y + \pi} - \frac{1}{y - \pi} + \frac{1}{y + 2\pi} + \frac{1}{y - 2\pi} - \dots \right] dy$$

$$= \int_0^{\pi} \sin y \cdot \operatorname{cosec} y \, dy = \int_0^{\pi} 1 \, dy = \pi$$

giving $I = \frac{\pi}{2}$ as before. (Hobson, *Trigonometry*, Art. 295)

This proof is similar to that of Method I, but makes use of the expression for $\operatorname{cosec} y$ in partial fractions instead of that for $\tan \frac{y}{2}$.

1000. METHOD III. **Illustrating Differentiation under an Integration Sign.**

(1) Consider the integral $I = \int_0^{\infty} e^{-kx} \frac{\sin r, x}{x} dx$, where r is positive and k any finite positive quantity, which we shall ultimately diminish without limit.

Then so long as k lies between 0 and $+\infty$,

$$\begin{aligned} \frac{\delta I}{\delta r} &= \int_0^\infty e^{-kx} \frac{\sin(r+\delta r)x - \sin rx}{\delta r} \frac{dx}{x} = \int_0^\infty e^{-kx} \cos(r+\theta \delta r)x dx, \quad (0 < \theta < 1), \\ &= \frac{k}{k^2 + (r + \theta \delta r)^2}, \quad (\text{Art. 96}), \end{aligned}$$

and proceeding to the limit when δr is indefinitely small,

$$\frac{dI}{dr} = \frac{k}{k^2 + r^2}, \quad \text{whence } I \equiv \int_0^\infty e^{-kx} \frac{\sin rx}{x} dx = \tan^{-1} \frac{r}{k},$$

no constant being needed since each side vanishes with r .

If in this result we diminish k indefinitely towards zero, the integral tends to the limit $\int_0^\infty \frac{\sin rx}{x} dx$, and $\tan^{-1} \frac{r}{k}$ tends to the limit $\frac{\pi}{2}$ or $-\frac{\pi}{2}$ according as r is positive or negative. But if $r=0$ the integral is obviously zero.

Hence $\int_0^\infty \frac{\sin rx}{x} dx = \frac{\pi}{2}$, 0 or $-\frac{\pi}{2}$ according as $r >$, = or $<$ 0.

(2) As a further illustration of this method, let

$$I_n \equiv \int_0^{\frac{\pi}{2}} \frac{d\theta}{(\alpha \cos^2 \theta + \beta \sin^2 \theta)^n},$$

α and β being of the same sign, so that the subject of integration has no infinity between the limits.

Let $\Delta \equiv \frac{\partial}{\partial \alpha} + \frac{\partial}{\partial \beta}$. Then $\Delta I_n = -n I_{n+1}$.

Hence

$$I_{n+1} = \frac{-1}{n} \Delta I_n = \frac{(-1)^2}{n(n-1)} \Delta^2 I_{n-1} = \text{etc.} = \frac{(-1)^n}{n!} \Delta^n I_1.$$

$$\text{Also } I_1 = \frac{1}{\beta} \int_0^{\frac{\pi}{2}} \frac{\sec^2 \theta d\theta}{\beta + \tan^2 \theta} = \frac{1}{\sqrt{\alpha\beta}} \left[\tan^{-1} \left(\sqrt{\frac{\beta}{\alpha}} \tan \theta \right) \right]_0^{\frac{\pi}{2}} = \frac{\pi}{2\sqrt{\alpha\beta}}.$$

Hence

$$I_2 = (-1) \frac{\pi}{2} \Delta \frac{1}{\sqrt{\alpha\beta}} = \frac{\pi}{4} \frac{1}{\sqrt{\alpha\beta}} \left(\frac{1}{\alpha} + \frac{1}{\beta} \right).$$

Similarly

$$I_3 = \frac{\pi}{16} \frac{1}{\sqrt{\alpha\beta}} \left(\frac{3}{\alpha^2} + \frac{2}{\alpha\beta} + \frac{3}{\beta^2} \right), \text{ and so on.}$$

And since

$$\begin{aligned} \left(\frac{\partial}{\partial \alpha} \right)^p \left(\frac{\partial}{\partial \beta} \right)^q \alpha^{-\frac{1}{2}} \beta^{-\frac{1}{2}} &= \frac{(-1)^{p+q}}{2^{p+q}} (1.3 \dots 2p-1)(1.3 \dots 2q-1) \frac{1}{\sqrt{\alpha\beta}} \frac{1}{\alpha^p \beta^q} \\ &= \frac{(-1)^{p+q} (2p)! (2q)!}{2^{2(p+q)} (p!) (q!)} \frac{1}{\sqrt{\alpha\beta}} \frac{1}{\alpha^p \beta^q}, \end{aligned}$$

the general result is

$$I_{n+1} = \frac{\pi}{2} \frac{(-1)^n}{n!} \left(\frac{\partial}{\partial a} + \frac{\partial}{\partial \beta} \right)^n \frac{1}{\sqrt{a\beta}}$$

$$= \frac{\pi}{2} \frac{(-1)^n}{n!} \sum_0^n n C_p \frac{(-1)^p (2p)! (2q)!}{2^{2n}} \frac{1}{p! q!} \frac{1}{\sqrt{a\beta} a^p \beta^q},$$

i.e. $I_{n+1} = \frac{\pi}{2^{2n+1}} \frac{1}{\sqrt{a\beta}} \sum_0^n \frac{(2p)! (2q)!}{(p!)^2 (q!)^2} \frac{1}{a^p \beta^q}$, where $p+q=n$.

Also, since

$$\frac{\partial I_n}{\partial a} = -n \int_0^{\frac{\pi}{2}} \frac{\cos^2 \theta \, d\theta}{(a \cos^2 \theta + \beta \sin^2 \theta)^{n+1}}, \quad \frac{\partial I_n}{\partial \beta} = -n \int_0^{\frac{\pi}{2}} \frac{\sin^2 \theta \, d\theta}{(a \cos^2 \theta + \beta \sin^2 \theta)^{n+1}},$$

all integrals of the forms

$$\int_0^{\frac{\pi}{2}} \frac{d\theta}{(a \cos^2 \theta + \beta \sin^2 \theta)^n}, \quad \int_0^{\frac{\pi}{2}} \frac{\cos^2 \theta \, d\theta}{(a \cos^2 \theta + \beta \sin^2 \theta)^n}, \quad \int_0^{\frac{\pi}{2}} \frac{\sin^2 \theta \, d\theta}{(a \cos^2 \theta + \beta \sin^2 \theta)^n},$$

can be computed, n being a positive integer and a, β of the same sign.

1001. Since

$$\int e^{-ax} \cos bx \, dx = e^{-ax} \frac{b \sin bx - a \cos bx}{a^2 + b^2} + \text{const.}$$

and $\int e^{-ax} \sin bx \, dx = -e^{-ax} \frac{b \cos bx + a \sin bx}{a^2 + b^2} + \text{const.},$

we have $\left. \begin{aligned} \int_0^\infty e^{-ax} \cos bx \, dx &= \frac{a}{a^2 + b^2} \dots\dots(1), \\ \int_0^\infty e^{-ax} \sin bx \, dx &= \frac{b}{a^2 + b^2} \dots\dots(2), \end{aligned} \right\} a \text{ being supposed positive.}$

Integrating the first of these equations with regard to b from 0 to b ,

$$\int_0^\infty e^{-ax} \frac{\sin bx}{x} \, dx = \tan^{-1} \frac{b}{a}, \dots\dots\dots(3)$$

and integrating the second from c to b (both positive) and

$$\int_0^\infty e^{-ax} \frac{\cos bx - \cos cx}{x} \, dx = \frac{1}{2} \log \frac{a^2 + c^2}{a^2 + b^2} \dots\dots\dots(4)$$

When a diminishes indefinitely the limiting form of (3) is

$$\int_0^\infty \frac{\sin bx}{x} \, dx = \frac{\pi}{2} \quad \text{or} \quad \frac{-\pi}{2}, \dots\dots\dots(5)$$

according as b is positive or negative.

If in equation (4) we make a diminish indefinitely,

$$\int_0^\infty \frac{\cos bx - \cos cx}{x} \, dx = \log \frac{c}{b} \dots\dots\dots(6)$$

If we differentiate (1) and (2) $n-1$ times with regard to a ,

$$\int_0^\infty x^{n-1} e^{-ax} \cos bx \, dx = (-1)^{n-1} \frac{d^{n-1}}{da^{n-1}} \frac{a}{a^2 + b^2} = \frac{(n-1)!}{b^n} \cos n\theta \sin^n \theta,$$

where $\tan \theta = \frac{b}{a}$,

and $\int_0^\infty x^{n-1} e^{-ax} \sin bx \, dx = (-1)^{n-1} \frac{d^{n-1}}{da^{n-1}} \frac{b}{a^2 + b^2} = \frac{(n-1)!}{b^n} \sin n\theta \sin^n \theta.$

Here n is a positive integer and a is positive.

The case when n is not a positive integer is considered later.

1002. METHOD IV. Deduction of a Definite Integral from the Summation Definition.

We may employ either of the well-known trigonometrical series

$$\frac{\pi - \theta}{2} = \sin \theta + \frac{1}{2} \sin 2\theta + \frac{1}{3} \sin 3\theta + \dots \text{ ad inf. } (\pi > \theta > -\pi),$$

$$\frac{\pi}{4} = \sin \theta + \frac{1}{3} \sin 3\theta + \frac{1}{5} \sin 5\theta + \dots \text{ ad inf. } (\pi > \theta > -\pi),$$

to obtain the value of $\int_0^{\infty} \frac{\sin x}{x} dx$.

$$\begin{aligned} (1) \quad \int_0^{\infty} \frac{\sin x}{x} dx &= Lt_{h=0} h \left(\frac{\sin h}{h} + \frac{\sin 2h}{2h} + \frac{\sin 3h}{3h} + \dots \right) \\ &= Lt_{h=0} \left(\frac{\sin h}{1} + \frac{\sin 2h}{2} + \frac{\sin 3h}{3} + \dots \right) \\ &= Lt_{h=0} \frac{\pi - h}{2} = \frac{\pi}{2}. \end{aligned}$$

$$\begin{aligned} (2) \quad \int_0^{\infty} \frac{\sin x}{x} dx &= Lt_{h=0} 2h \left(\frac{\sin h}{h} + \frac{\sin 3h}{3h} + \frac{\sin 5h}{5h} + \dots \right) \\ &= Lt_{h=0} 2 \left(\frac{\sin h}{1} + \frac{\sin 3h}{3} + \frac{\sin 5h}{5} + \dots \right) \\ &= 2 \times \frac{\pi}{4} = \frac{\pi}{2}. \end{aligned}$$

[For the first series see *Diff. Calc.*, p. 108, Ex. 21 (2).

For the second add to the first $\frac{\theta}{2} = \sin \theta - \frac{1}{2} \sin 2\theta + \frac{1}{3} \sin 3\theta - \dots$, or otherwise. (Hobson, *Trigonometry*, p. 288.)

See Bertrand, *Calcul. Diff. et Int.*, vol. i., pages 304, 383.]

1003. METHOD V. Again illustrating Derivation from the Definition of an Integral as a Summation.

Consider the series

$$S = \frac{e^{-q\theta} \sin \theta}{1} + \frac{e^{-2q\theta} \sin 2\theta}{2} + \frac{e^{-3q\theta} \sin 3\theta}{3} + \dots \text{ ad inf.}$$

Let
$$C = \frac{e^{-q\theta} \cos \theta}{1} + \frac{e^{-2q\theta} \cos 2\theta}{2} + \frac{e^{-3q\theta} \cos 3\theta}{3} + \dots$$

These series are convergent so long as q is positive.

$$\begin{aligned} C + iS &= \sum_1^{\infty} \frac{e^{-nq\theta} e^{ni\theta}}{n} = -\log(1 - e^{-q\theta} e^{i\theta}) \\ &= -\log \sqrt{1 - 2e^{-q\theta} \cos \theta + e^{-2q\theta}} + i \tan^{-1} \frac{e^{-q\theta} \sin \theta}{1 - e^{-q\theta} \cos \theta}; \\ \therefore S &= \tan^{-1} \frac{\sin \theta}{e^{q\theta} - \cos \theta}. \end{aligned}$$

In the limit when θ is made indefinitely small,

$$S = \tan^{-1} L_{\theta=0} \frac{\cos \theta}{q e^{q\theta} + \sin \theta} = \tan^{-1} \frac{1}{q} = \frac{\pi}{2} - \tan^{-1} q.$$

Now

$$\begin{aligned} \int_0^{\infty} \frac{e^{-qx} \sin x}{x} dx &= L_{h=0} h \left[\frac{e^{-qh} \sin h}{h} + \frac{e^{-2qh} \sin 2h}{2h} + \frac{e^{-3qh} \sin 3h}{3h} + \dots \right] \\ &= L_{h=0} \left[\frac{e^{-qh} \sin h}{1} + \frac{e^{-2qh} \sin 2h}{2} + \frac{e^{-3qh} \sin 3h}{3} + \dots \right], \\ \int_0^{\infty} \frac{e^{-qx} \sin x}{x} dx &= \frac{\pi}{2} - \tan^{-1} q. \end{aligned}$$

Now let q diminish indefinitely to zero, the limit towards which the result tends without limit is

$$\int_0^{\infty} \frac{\sin x}{x} dx = \frac{\pi}{2}.$$

1004. The integral $I = \int_0^{\infty} \frac{e^{-qx} \sin rx}{x} dx = \tan^{-1} \frac{r}{q}$ may be established for the case $q > r$ thus; expanding $\sin rx$, we have

$$I = \int_0^{\infty} e^{-qx} \left(r - \frac{r^3 x^2}{3!} + \frac{r^5 x^4}{5!} - \dots \right) dx.$$

But
$$\int_0^{\infty} x^n e^{-qx} dx = \frac{n!}{q^{n+1}};$$

$$\therefore I = \frac{r}{q} - \frac{1}{3} \frac{r^3}{q^3} + \frac{1}{5} \frac{r^5}{q^5} - \dots = \tan^{-1} \frac{r}{q}.$$

This series, however, is divergent if $q < r$. See Art. 1000 (1).

1005. METHOD VI. Illustration of Use of Change of Order of Integration.

Consider the double integral

$$I \equiv \int_0^{\infty} \int_0^{\infty} e^{-xy} \sin rx \, dx \, dy.$$

Integrating first with respect to y ,

$$I \equiv \int_0^{\infty} \left[-e^{-xy} \frac{\sin rx}{x} \right]_{y=0}^{y=\infty} dx = \int_0^{\infty} \frac{\sin rx}{x} dx.$$

Changing the order of integration, integrate first with regard to x ,

$$\begin{aligned} I &\equiv \int_0^{\infty} \left[-e^{-xy} \frac{y \sin rx + r \cos rx}{r^2 + y^2} \right]_{x=0}^{x=\infty} dy \\ &= \int_0^{\infty} \frac{r}{r^2 + y^2} dy = \left[\tan^{-1} \frac{y}{r} \right]_0^{\infty} = \frac{\pi}{2} \quad \text{or} \quad -\frac{\pi}{2}, \end{aligned}$$

according as r is positive or negative ;

$$\therefore \int_0^{\infty} \frac{\sin rx}{x} dx = \frac{\pi}{2} \quad \text{or} \quad -\frac{\pi}{2},$$

according as r is positive or negative.

1006. METHOD VII. The integral may also be established by the method of contour integration. (See Art. 1302.)

1007. The expression for $\cot z$ in partial fractions (Hobson, *Trigonometry*, p. 334) is

$$\begin{aligned}\cot z &= \frac{1}{z} + \frac{1}{z+\pi} + \frac{1}{z-\pi} + \frac{1}{z+2\pi} + \frac{1}{z-2\pi} + \frac{1}{z+3\pi} + \frac{1}{z-3\pi} + \dots \\ &= \frac{1}{z} + 2z \sum_1^{\infty} \frac{1}{z^2 - r^2 \pi^2}.\end{aligned}$$

If $\phi(z)$ be any periodic function of z with periodicity π , i.e. such that $\phi(z) = \phi(z+r\pi)$ for all positive or negative integral values of r , we have

$$\int_{-\infty}^{\infty} \frac{\phi(z)}{z} dz = \left\{ \begin{array}{l} \int_0^{\pi} + \int_{\pi}^{2\pi} + \int_{2\pi}^{3\pi} + \dots \\ + \int_{-\pi}^0 + \int_{-2\pi}^{-\pi} + \int_{-3\pi}^{-2\pi} + \dots \end{array} \right\} \frac{\phi(z)}{z} dz.$$

In these integrals, put

$$z = y, \quad \pi + y, \quad 2\pi + y \dots \text{ in the first row,}$$

and

$$-\pi + y, \quad -2\pi + y \dots \text{ in the second row.}$$

$$\int_{r\pi}^{(r+1)\pi} \frac{\phi(z)}{z} dz = \int_0^{\pi} \frac{\phi(r\pi + y)}{r\pi + y} dy = \int_0^{\pi} \frac{\phi(y)}{r\pi + y} dy,$$

$$\int_{-(r-1)\pi}^{-r\pi} \frac{\phi(z)}{z} dz = \int_0^{\pi} \frac{\phi(y - r\pi)}{y - r\pi} dy = \int_0^{\pi} \frac{\phi(y)}{y - r\pi} dy.$$

Hence

$$\begin{aligned}\int_{-\infty}^{\infty} \frac{\phi(z)}{z} dz &= \int_0^{\pi} \phi(y) \left[\frac{1}{y} + \frac{1}{y+\pi} + \frac{1}{y-\pi} + \frac{1}{y+2\pi} + \frac{1}{y-2\pi} + \dots \right] dy \\ &= \int_0^{\pi} \phi(y) \cot y dy,\end{aligned}$$

$$\text{i.e. } \int_{-\infty}^{\infty} \frac{\phi(x) dx}{x} = \int_0^{\pi} \phi(x) \cot x dx, \quad \text{where } \phi(x) = \phi(x+r\pi).$$

$$\text{Thus, if } \phi(x) = \tan x, \quad \int_{-\infty}^{\infty} \frac{\tan x}{x} dx = \int_0^{\pi} \tan x \cot x dx = \pi.$$

Also $\frac{\tan x}{x}$ is not affected by a change of sign of x , and its graph is symmetrical about the y -axis.

$$\text{Hence } \int_0^{\infty} \frac{\tan x}{x} dx = \frac{1}{2} \int_{-\infty}^{\infty} \frac{\tan x}{x} dx = \frac{\pi}{2},$$

and writing rx for x ,

$$\int_0^\infty \frac{\tan rx}{x} dx = \frac{\pi}{2}, \quad -\frac{\pi}{2} \text{ or } 0 \text{ as } r \text{ is } +ve, -ve \text{ or zero.}$$

1008. We now proceed to consider some consequences of the result

$$\int_0^\infty \frac{\sin rx}{x} dx = \frac{\pi}{2}.$$

By the ordinary method of summation, we have

$${}^p C_0 \sin 2px + {}^p C_1 \sin(2p-2)x + \dots + {}^p C_{p-1} \sin 2x = 2^p \cos^p x \sin px;$$

$$\therefore \int_0^\infty \frac{\cos^p x \sin px}{x} dx = \frac{1}{2^p} \cdot \frac{\pi}{2} [{}^p C_0 + {}^p C_1 + \dots + {}^p C_{p-1}] = \frac{\pi}{2} \left(1 - \frac{1}{2^p}\right).$$

1009. In the same way

$${}^p C_0 \sin 2px - {}^p C_1 \sin(2p-2)x + \dots + (-1)^{p-1} {}^p C_{p-1} \sin 2x$$

$$= (-1)^{\frac{p}{2}} 2^p \sin^p x \sin px, \quad (p \text{ even})$$

$$\text{or } = (-1)^{\frac{p-1}{2}} 2^p \sin^p x \cos px, \quad (p \text{ odd}).$$

$$\text{Hence } \int_0^\infty \frac{\sin^{2n} x \sin 2nx}{x} dx = \frac{(-1)^n}{2^{2n}} \cdot \frac{\pi}{2} [(1-1)^{2n} - 1] = (-1)^{n+1} \frac{\pi}{2^{2n+1}},$$

$$\text{and } \int_0^\infty \frac{\sin^{2n+1} x \cos(2n+1)x}{x} dx = \frac{(-1)^n}{2^{2n+1}} \frac{\pi}{2} [(1-1)^{2n+1} + 1] = (-1)^n \frac{\pi}{2^{2n+1}}.$$

1010. Again,

$$\int_0^\infty \frac{\sin^{2n+1} x}{x} dx = \frac{(-1)^n}{2^{2n}} \int_0^\infty [\sin(2n+1)x - {}^{2n+1} C_1 \sin(2n-1)x + \dots + (-1)^n {}^{2n+1} C_n \sin x] \frac{dx}{x}$$

$$= \frac{(-1)^n}{2^{2n}} \frac{\pi}{2} [1 - {}^{2n+1} C_1 + {}^{2n+1} C_2 - \dots + (-1)^n {}^{2n+1} C_n]$$

$$= \frac{1}{2^{2n}} \frac{\pi}{2} \times \text{coeff. of } z^n \text{ in } (1+z)^{2n+1} \times (1+z)^{-1} = \frac{\pi}{2^{2n+1}} {}^{2n} C_n$$

$$= \frac{\pi}{2} \frac{1 \cdot 3 \cdot 5 \dots (2n-1)}{2 \cdot 4 \cdot 6 \dots 2n}.$$

1011. Let a and b be any two positive quantities ($a > b$).

$$\text{Then } \int_0^\infty \frac{\sin(a+b)x}{x} dx = \frac{\pi}{2} \quad \text{and} \quad \int_0^\infty \frac{\sin(a-b)x}{x} dx = \frac{\pi}{2}.$$

Hence, adding and subtracting,

$$\int_0^\infty \frac{\sin ax \cos bx}{x} dx = \frac{\pi}{2} \quad \text{and} \quad \int_0^\infty \frac{\cos ax \sin bx}{x} dx = 0.$$

We may then state that

$$\int_0^{\infty} \frac{\sin px \cos qx}{x} dx = \frac{\pi}{2} \text{ or } 0, \text{ according as } p > q \text{ or } < q$$

both being considered positive.

If $p=q$,

$$\int_0^{\infty} \frac{\sin px \cos qx}{x} dx = \frac{1}{2} \int_0^{\infty} \frac{\sin 2px}{x} dx = \frac{1}{2} \cdot \frac{\pi}{2} = \frac{\pi}{4}.$$

1012. Graphical Illustrations.

Consider the graph of $y = \int_0^{\infty} \frac{\sin x\theta \cos \theta}{\theta} d\theta$.

We may write this as $y = \frac{1}{2} \int_0^{\infty} \frac{\sin(x+1)\theta + \sin(x-1)\theta}{\theta} d\theta$.

$$\text{If } x > 1, \quad y = \frac{1}{2} \left(\frac{\pi}{2} + \frac{\pi}{2} \right) = \frac{\pi}{2}.$$

$$\text{If } x = 1, \quad y = \frac{1}{2} \left(\frac{\pi}{2} + 0 \right) = \frac{\pi}{4}.$$

$$\text{If } x < 1 \text{ and } > -1, \quad y = \frac{1}{2} \left(\frac{\pi}{2} - \frac{\pi}{2} \right) = 0.$$

$$\text{If } x = -1, \quad y = \frac{1}{2} \left(0 - \frac{\pi}{2} \right) = -\frac{\pi}{4}.$$

$$\text{If } x < -1, \quad y = \frac{1}{2} \left(-\frac{\pi}{2} - \frac{\pi}{2} \right) = -\frac{\pi}{2}.$$

Hence the graph is discontinuous and as shown in Fig. 325.

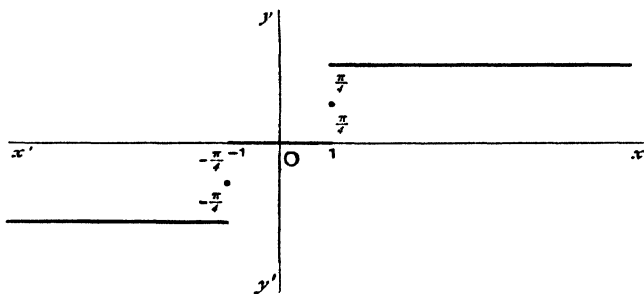

Fig. 325.

1013. Graph of $y = \int_0^{\infty} \frac{\sin \theta \cos x\theta}{\theta} d\theta$

$$= \frac{1}{2} \int_0^{\infty} \frac{\sin(1+x)\theta + \sin(1-x)\theta}{\theta} d\theta.$$

Here, if $x > 1$, $y = \frac{1}{2} \left(\frac{\pi}{2} - \frac{\pi}{2} \right) = 0$;
 $x = 1$, $y = \frac{1}{2} \left(\frac{\pi}{2} + 0 \right) = \frac{\pi}{4}$;
 $-1 < x < 1$, $y = \frac{1}{2} \left(\frac{\pi}{2} + \frac{\pi}{2} \right) = \frac{\pi}{2}$;
 $x = -1$, $y = \frac{1}{2} \left(0 + \frac{\pi}{2} \right) = \frac{\pi}{4}$;
 $x < -1$, $y = \frac{1}{2} \left(-\frac{\pi}{2} + \frac{\pi}{2} \right) = 0$;

and the graph is as shown in Fig. 326.

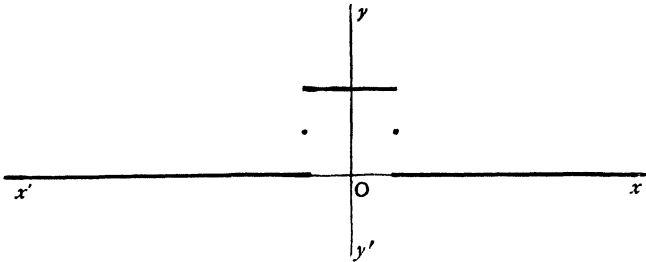

Fig. 326.

being again discontinuous at $x = 1$ and $x = -1$.

1014. Consider the integral

$$\int_0^h \frac{\cos z - 1}{z} dz,$$

and put $z = ax$ and $z = bx$ therein alternately.

Then
$$\int_0^{\frac{h}{a}} \frac{\cos ax - 1}{x} dx = \int_0^{\frac{h}{b}} \frac{\cos bx - 1}{x} dx,$$

i.e.
$$\int_0^{\frac{h}{a}} \frac{\cos ax - \cos bx}{x} dx - \int_{\frac{h}{a}}^{\frac{h}{b}} \frac{\cos bx}{x} dx = \int_{\frac{h}{a}}^{\frac{h}{b}} \frac{1}{x} dx = \log \frac{b}{a}.$$

Now
$$\int_{\frac{h}{a}}^{\frac{h}{b}} \frac{\cos bx}{x} dx = \left[\frac{\sin bx}{b} \cdot \frac{1}{x} \right]_{\frac{h}{a}}^{\frac{h}{b}} + \frac{1}{b} \int_{\frac{h}{a}}^{\frac{h}{b}} \frac{\sin bx}{x^2} dx,$$

and when h is increased indefinitely, becomes $\frac{1}{b} \int_{\frac{h}{a}}^{\frac{h}{b}} \frac{\sin bx}{x^2} dx,$

and this must lie in numerical magnitude intermediate between the results obtained by replacing $\sin bx$ by -1 and by $+1$

respectively, *i.e.* between $\pm \frac{1}{b} \left[-\frac{1}{x} \right]_{\frac{h}{a}}^{\frac{h}{b}}$ or $\pm \frac{a \sim b}{bh}$, *i.e.* ± 0 .

Therefore the second integral, for the infinite interval between $\frac{h}{a}$ and $\frac{h}{b}$ vanishes, and we have

$$\int_0^\infty \frac{\cos ax - \cos bx}{x} dx = \log \frac{b}{a}.$$

This is a special case of a theorem due to Frullani to be proved later (Art. 1183).

1015. It follows that

$$\int_0^x \frac{\sin \frac{b-a}{2} x \sin \frac{b+a}{2} x}{x} dx = \frac{1}{2} \log \frac{b}{a},$$

i.e. $\int_0^\infty \frac{\sin px \sin qx}{x} dx = \frac{1}{2} \log \frac{p+q}{p-q}$ ($p > q$ and both positive).

We have now considered

$$\int_0^\infty \frac{\sin px \sin qx}{x} dx = \frac{1}{2} \log \frac{p+q}{p-q},$$

and $\int_0^\infty \frac{\sin px \cos qx}{x} dx = \frac{\pi}{2}$ or 0 , as $p >$ or $< q$ (Art. 1011).

Also $\int_0^\infty \frac{\cos px \cos qx}{x} dx$ is infinite (Art. 348).

1016. Taking $y = \int_0^\infty \frac{\sin r\theta}{\theta} d\theta = \frac{\pi}{2}$ or $-\frac{\pi}{2}$,

as r is positive or negative, or 0 if $r=0$, integrate with regard to r from $r=0$ to $r=r$,

$$y = \int_0^\infty \frac{1 - \cos r\theta}{\theta^2} d\theta = \frac{\pi r}{2} \text{ or } -\frac{\pi r}{2}, \dots\dots\dots(1)$$

as r is positive or negative, or 0 if $r=0$; *i.e.* putting $2r$ for r ,

$$y = \int_0^\infty \frac{\sin^2 r\theta}{\theta^2} d\theta = \frac{\pi r}{2} \text{ or } -\frac{\pi r}{2}, \dots\dots\dots(2)$$

as r is positive or negative, or 0 if r be zero.

1017. To illustrate this geometrically, consider the graph of

$$y = \frac{2}{\pi} \int_0^{\infty} \frac{\sin^2 x \theta}{\theta^2} d\theta,$$

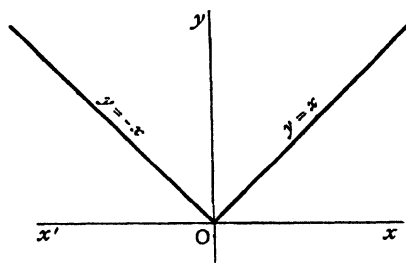

Fig. 327.

which consists of the parts of the lines $y = \pm x$ which lie in the first and second quadrants.

1018. Integrate equation (1) with respect to r between limits 0 and r .

Then $\int_0^{\infty} \frac{r\theta \sin r\theta}{\theta^3} d\theta = \frac{\pi}{4} r^2$ or $-\frac{\pi}{4} r^2$, as r is positive or negative.

Thus the graph of $y = \frac{4}{\pi} \int_0^{\infty} \frac{x\theta \sin x\theta}{\theta^3} d\theta$ consists of the parts of the two parabolas $y = x^2$ and $y = -x^2$, as x is positive or negative, which lie in the first and third quadrants.

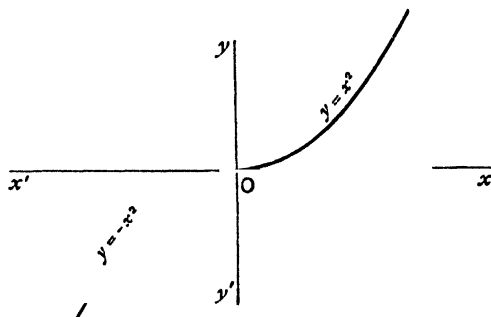

Fig. 328.

Similarly we might proceed to further integrations.

1019. Graph of $y = \frac{2a}{\pi} \int_0^{\infty} \frac{\sin^2\left(\theta \sin \frac{x}{a}\right)}{\theta^2} d\theta$.

Since a change of sign of x evidently does not affect the value of the integral, the y -axis is an axis of symmetry.

Also

$y = a \sin \frac{x}{a}$ if $\sin \frac{x}{a}$ be positive and $y = -a \sin \frac{x}{a}$ if $\sin \frac{x}{a}$ be negative.

Hence the graph is that shown in Fig. 329.

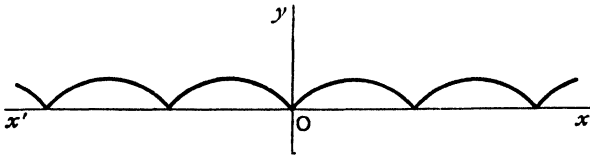

Fig. 329.

1020. If we integrate $\int_0^{\infty} \frac{\sin r\theta}{\theta} d\theta = +\frac{\pi}{2}$ with regard to r between limits q and p (both positive and $p > q$), we obtain

$$\int_0^{\infty} \frac{\cos q\theta - \cos p\theta}{\theta^2} d\theta = \frac{\pi}{2}(p - q),$$

i.e.
$$\int_0^{\infty} \frac{\sin \frac{p+q}{2}\theta \sin \frac{p-q}{2}\theta}{\theta^2} d\theta = \frac{\pi}{4}(p - q),$$

or putting $p + q = 2a$, $p - q = 2b$,

$$\int_0^{\infty} \frac{\sin a\theta \sin b\theta}{\theta^2} d\theta = \frac{\pi}{2}b,$$

where b is the smaller of the two quantities a and b .

1021. Trace the graph of $y = \int_0^{\infty} \frac{\sin^2 \theta \cos r\theta}{\theta^2} d\theta$.

In the first place a change of sign of r does not affect y . Hence the y -axis is an axis of symmetry.

Also we have

$$\begin{aligned} y &= \frac{1}{2} \int_0^{\infty} \frac{\sin \theta}{\theta^2} \{\sin(x+1)\theta - \sin(x-1)\theta\} d\theta \\ &= \frac{1}{2} \int_0^{\infty} \frac{\sin \theta \sin(x+1)\theta}{\theta^2} d\theta - \frac{1}{2} \int_0^{\infty} \frac{\sin \theta \sin(x-1)\theta}{\theta^2} d\theta. \end{aligned}$$

$$\text{If } x > 2, \quad y = \frac{1}{2} \cdot \frac{\pi}{2} \cdot 1 - \frac{1}{2} \cdot \frac{\pi}{2} \cdot 1 = 0.$$

$$\text{If } x = 2, \quad y = \frac{1}{2} \cdot \frac{\pi}{2} \cdot 1 - \frac{1}{2} \cdot \frac{\pi}{2} \cdot 0 = \frac{\pi}{4}.$$

$$\text{If } 2 > x > 1, \quad y = \frac{1}{2} \cdot \frac{\pi}{2} \cdot 1 - \frac{1}{2} \cdot \frac{\pi}{2} (x-1) = \frac{\pi}{4}(2-x).$$

$$\text{If } x = 1, \quad y = \frac{1}{2} \cdot \frac{\pi}{2} \cdot 1 - 0 = \frac{\pi}{4}.$$

$$\text{If } 1 > x > 0, \quad y = \frac{1}{2} \cdot \frac{\pi}{2} \cdot 1 + \frac{1}{2} \cdot \frac{\pi}{2} (1-x) = \frac{\pi}{4}(2-x).$$

$$\text{If } x = 0, \quad y = \frac{1}{2} \cdot \frac{\pi}{2} + \frac{1}{2} \cdot \frac{\pi}{2} = \frac{\pi}{2}.$$

The graph therefore consists of :

- (a) the portion of the x -axis from $x=2$ to $x=\infty$,
- (b) the portion of the line $y = \frac{\pi}{2} - \frac{\pi x}{4}$ from $x=0$ to $x=2$,
- (c) the portion of $y = \frac{\pi}{2} + \frac{\pi x}{4}$ from $x=-2$ to $x=0$,
- (d) the portion of the x -axis from $x=-\infty$ to $x=-2$.

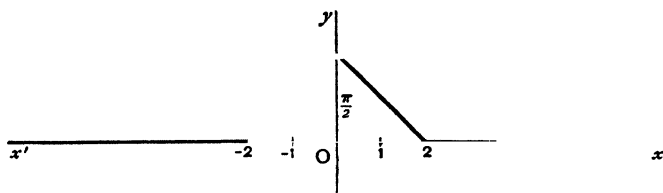

Fig. 330.

And the discontinuous nature is shown in the illustration (Fig. 330).

1022. Trace the graph of $y = \int_0^x \frac{\sin^2 \theta \sin x \theta}{\theta^2} d\theta$. (Math. Tripos, 1895.)

We note in the first place that a change of sign of x gives a change of sign of y . That is, the origin is a centre of symmetry.

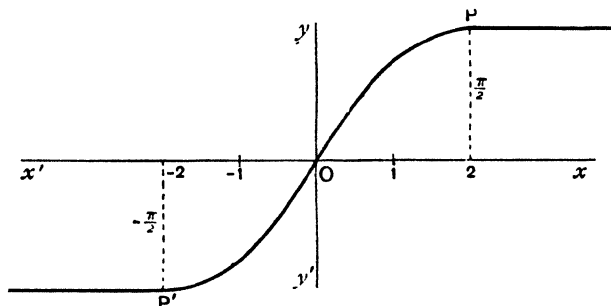

Fig. 331.

$$\text{Also } \frac{dy}{dx} = \int_0^\infty \frac{\sin^2 \theta \cos x \theta}{\theta^2} d\theta = \begin{cases} \pi(2-x)/4 & \text{from } x=0 \text{ to } x=2, \\ 0 & \text{from } x=2 \text{ to } x=\infty; \end{cases}$$

$$\therefore y = \begin{cases} A + \pi(4x - x^2)/8 & \text{from } x=0 \text{ to } x=2, \\ B & \text{from } x=2 \text{ to } x=\infty, \end{cases}$$

where A and B are constants.

Moreover, the difference of adjacent ordinates at $x-\epsilon$, $x+\epsilon$, being to the first order $2\epsilon \int_0^\infty \frac{\sin^2 \theta \cos x \theta}{\theta^2} d\theta$, ultimately vanishes with ϵ , and therefore there is no abrupt change of ordinate at any point on the graph.

Again, $y=0$ if $x=0$; $\therefore A=0$;

and at $x=2$, $A + \pi(4 \cdot 2 - 2^2)/8 = B$; $\therefore B = \frac{\pi}{2}$.

Therefore the graph in the first quadrant consists of a portion of the parabola $y = \pi(4x - x^2)/8$ from $x=0$ to $x=2$, the vertex being at $(2, \pi/2)$, and a line, $2y = \pi$, parallel to the x -axis from $x=2$ to $x=\infty$.

And remembering that there is symmetry with regard to the origin, the graph is as shown in Fig. 331.

It appears that the points P, P' , where two of the discontinuities occur, are the vertices of the two parabolic arcs, and that at the third discontinuity which occurs at the origin the parabolas have the same tangent.

The discontinuities occur in the *second* differential coefficient.

$$1023. \text{ Cases of } \int_0^{\infty} \frac{\sin^m x}{x^n} dx.$$

Let $u_{m,n} = \int_0^{\infty} \frac{\sin^m x}{x^n} dx$, where m is not less than n , and m, n are either both odd or both even positive integers > 2 . We have proved in Art. 265 a reduction formula connecting $u_{m,n}$, $u_{m,n-2}$ and $u_{m-2,n-2}$, viz.

$$(n-1)(n-2)u_{m,n} + m^2 u_{m,n-2} - m(m-1)u_{m-2,n-2} = 0.$$

Now we have $u_{1,1} = \frac{\pi}{2}$, $u_{2,2} = \frac{\pi}{2}$ (Art. 1016),

$$\text{and } u_{3,1} = \int_0^{\infty} \frac{\sin^3 x}{x} dx = \frac{1}{4} \int_0^{\infty} \frac{3 \sin x - \sin 3x}{x} dx = \frac{1}{4} [3-1] \frac{\pi}{2} = \frac{\pi}{4};$$

and from the reduction formula,

$$\left. \begin{array}{l} m=3 \\ n=3 \end{array} \right\} 2 \cdot 1 u_{3,3} + 9 u_{3,1} - 3 \cdot 2 u_{1,1} = 0;$$

$$\therefore 2u_{3,3} = 6 \cdot \frac{\pi}{2} - 9 \cdot \frac{\pi}{4} = \frac{3\pi}{4}; \quad \therefore u_{3,3} = \frac{3\pi}{8}.$$

$$\begin{aligned} \text{Also } u_{5,1} &= \int_0^{\infty} \frac{\sin^5 x}{x} dx = \frac{1}{2^4} \int_0^{\infty} \frac{\sin 5x - 5 \sin 3x + 10 \sin x}{x} dx \\ &= \frac{1}{2^4} (1 - 5 + 10) \frac{\pi}{2} = \frac{3\pi}{16}. \end{aligned}$$

Then the reduction formula,

$$\left. \begin{array}{l} m=5 \\ n=3 \end{array} \right\} \text{ gives } 2 \cdot 1 u_{5,3} + 25 u_{5,1} - 5 \cdot 4 u_{3,1} = 0,$$

$$\text{and } \left. \begin{array}{l} m=5 \\ n=5 \end{array} \right\} \text{ gives } 4 \cdot 3 u_{5,5} + 25 u_{5,3} - 5 \cdot 4 u_{3,3} = 0;$$

$$\text{whence } u_{5,3} = \frac{5\pi}{32}, \quad u_{5,5} = \frac{115}{384} \pi, \text{ etc.}$$

1024. In order to generalise these results it will be plain that it is necessary to express $\sin^{2r+1}x$ in the form

$$A \sin x + B \sin 3x + C \sin 5x + \dots,$$

and then we shall have

$$u_{2r+1,1} = \int_0^{\infty} \frac{\sin^{2r+1}x}{x} dx = \frac{\pi}{2} (A + B + C + \dots)$$

(see Art. 1010).

And similarly if we can obtain

$\sin^{2r-1}x \cos x$ in the form $A_1 \sin 2x + B_1 \sin 4x + C_1 \sin 6x + \dots$, we shall have

$$\begin{aligned} u_{2r,2} &= \int_0^{\infty} \frac{\sin^{2r}x}{x^2} dx = \left[-\frac{\sin^{2r}x}{x} \right]_0^{\infty} + 2r \int_0^{\infty} \frac{\sin^{2r-1}x \cos x}{x} dx \\ &= 2r \int_0^{\infty} \frac{\sin^{2r-1}x \cos x}{x} dx \\ &= 2r(A_1 + B_1 + C_1 + \dots) \frac{\pi}{2}, \end{aligned}$$

and the sums $A + B + C + \dots$, and $A_1 + B_1 + C_1 + \dots$ are easy to find. (Art. 1026.)

1025. It has been shown in Art. 1010 that

$$u_{2r+1,1} = \frac{\pi}{2} \frac{1 \cdot 3 \cdot 5 \dots (2r-1)}{2 \cdot 4 \cdot 6 \dots 2r},$$

and this with the reduction formula will enable us to obtain the values of all integrals of form $u_{2n+1,2p+1}$ ($n \leq p$).

Thus, if $r=3$,
$$u_{7,1} = \frac{1 \cdot 3 \cdot 5}{2 \cdot 4 \cdot 6} \cdot \frac{\pi}{2} = \frac{5\pi}{2^5},$$

and

$$\left. \begin{aligned} 2 \cdot 1 u_{7,3} + 49 u_{7,1} - 42 u_{5,1} &= 0, \\ 4 \cdot 3 u_{7,5} + 49 u_{7,3} - 42 u_{5,3} &= 0, \\ 6 \cdot 5 u_{7,7} + 49 u_{7,5} - 42 u_{5,5} &= 0, \end{aligned} \right\}$$

giving $u_{7,3} = \frac{7\pi}{64}$, $u_{7,5} = \frac{77\pi}{768}$, $u_{7,7} = \frac{5887\pi}{23040}$, and so on.

Collecting the results, we have

$$u_{1,1} = \frac{\pi}{2},$$

$$u_{3,1} = \frac{\pi}{4}, \quad u_{3,3} = \frac{3\pi}{8},$$

$$u_{5,1} = \frac{3\pi}{16}, \quad u_{5,3} = \frac{5\pi}{32}, \quad u_{5,5} = \frac{115\pi}{384},$$

$$u_{7,1} = \frac{5\pi}{32}, \quad u_{7,3} = \frac{7\pi}{64}, \quad u_{7,5} = \frac{77\pi}{768}, \quad u_{7,7} = \frac{5887\pi}{23040},$$

etc.

$$u_{2r+1,1} = \frac{1 \cdot 3 \cdot 5 \dots (2r-1)}{2 \cdot 4 \cdot 6 \dots 2r} \cdot \frac{\pi}{2}, \quad \text{the same result as } \int_0^{\frac{\pi}{2}} \sin^{2r} \theta d\theta.$$

1026. Again by differentiating the formula

$$2^{2r}(-1)^r \sin^{2r} x = 2 \sum_{s=0}^{s=r-1} (-1)^s {}^{2r}C_s \cos(2r-2s)x + (-1)^r {}^{2r}C_r,$$

we obtain

$$2r \sin^{2r-1} x \cos x = \frac{(-1)^{r-1}}{2^{2r-1}} \sum_{s=0}^{s=r-1} (-1)^s (2r-2s) {}^{2r}C_s \sin(2r-2s)x,$$

and the sum of the coefficients required (Art. 1024) is

$$\begin{aligned} & \frac{(-1)^{r-1}}{2^{2r} \cdot r} \{2r {}^{2r}C_0 - (2r-2) {}^{2r}C_1 + (2r-4) {}^{2r}C_2 - \dots + (-1)^{r-1} 2 {}^{2r}C_{r-1}\} \\ &= \frac{1}{2^{2r-1} \cdot r} \{2 {}^{2r}C_{r-1} - 2 {}^{2r}C_{r-2} + 3 {}^{2r}C_{r-3} - \dots + (-1)^{r-1} r {}^{2r}C_0\} \\ &= \frac{1}{2^{2r-1} \cdot r} \times \text{coef. of } z^{r-1} \text{ in } (1+z)^{2r} \times (1+z)^{-2} \\ &= \frac{1}{2^{2r-1} \cdot r} \times \text{coef. of } z^{r-1} \text{ in } (1+z)^{2r-2} = \frac{1}{2^{2r-1} \cdot r} \frac{(2r-2)!}{\{(r-1)!\}^2}. \end{aligned}$$

$$\text{Hence } u_{2r,2} \equiv \int_0^{\frac{\pi}{2}} \frac{\sin^{2r} x}{x^2} dx = \frac{1 \cdot 3 \cdot 5 \dots (2r-3)}{2 \cdot 4 \cdot 6 \dots (2r-2)} \frac{\pi}{2} \text{ if } r \neq 2,$$

$$\text{and } = \frac{\pi}{2} \text{ if } r=1, \text{ and } = \frac{\pi}{4} \text{ if } r=2.$$

1027. Thus

$$u_{2,2} = \frac{\pi}{2}; \quad u_{1,2} = \frac{\pi}{4}; \quad u_{3,2} = \frac{1 \cdot 3}{2 \cdot 4} \cdot \frac{\pi}{2} = \frac{3\pi}{16}; \quad u_{5,2} = \frac{1 \cdot 3 \cdot 5}{2 \cdot 4 \cdot 6} \cdot \frac{\pi}{2} = \frac{5\pi}{32}; \quad \text{etc.},$$

the first of these having been found before.

And now the reduction formula can be used,

$$(n-1)(n-2)u_{m,n} + m^2 u_{m,n-2} - m(m-1)u_{m-2,n-2} = 0 \quad (m \nless n),$$

$$\left. \begin{array}{l} m=4 \\ n=4 \end{array} \right\} 3 \cdot 2u_{4,4} + 16u_{4,2} - 4 \cdot 3u_{2,2} = 0;$$

$$\left. \begin{array}{l} m=6 \\ n=4 \end{array} \right\} 3 \cdot 2u_{6,4} + 36u_{6,2} - 6 \cdot 5u_{4,2} = 0;$$

$$\left. \begin{array}{l} m=6 \\ n=6 \end{array} \right\} 5 \cdot 4u_{6,6} + 36u_{6,4} - 6 \cdot 5u_{4,4} = 0;$$

etc.,

$$\text{giving } u_{4,4} = \frac{\pi}{3}, \quad u_{6,4} = \frac{\pi}{8}, \quad u_{6,6} = \frac{11\pi}{40}, \quad \text{etc.},$$

and collecting the results,

$$u_{2,2} = \frac{\pi}{2},$$

$$u_{4,2} = \frac{\pi}{4}, \quad u_{4,4} = \frac{\pi}{3},$$

$$u_{6,2} = \frac{3\pi}{16}, \quad u_{4,4} = \frac{\pi}{8}, \quad u_{6,6} = \frac{11\pi}{40},$$

$$u_{8,2} = \frac{5\pi}{32}, \text{ etc. ;}$$

and generally,

$$u_{2r,2} = \frac{1 \cdot 3 \cdot 5 \dots (2r-3)}{2 \cdot 4 \cdot 6 \dots (2r-2)} \cdot \frac{\pi}{2} \quad (r \neq 2), \text{ and therefore } = \int_0^{\frac{\pi}{2}} \sin^{2r-2} \theta d\theta.$$

1028. A result due to Wolstenholme follows at once, viz.

$$\int_{-\infty}^{\infty} \frac{\sin^2 x}{x^2} F(\sin^2 x) dx = \int_0^{\pi} F(\sin^2 x) dx,$$

provided $F(z)$ be any function of z which can be expanded in a convergent series of positive integral powers of z . For let

$$F(z) \equiv A_0 + A_1 z + A_2 z^2 + \dots$$

Then

$$\begin{aligned} \int_{-\infty}^{\infty} \frac{\sin^2 x}{x^2} F(\sin^2 x) dx &= 2 \int_0^{\infty} \frac{\sin^2 x}{x^2} (A_0 + A_1 \sin^2 x + A_2 \sin^4 x + \dots) dx \\ &= 2(A_0 u_{2,2} + A_1 u_{4,2} + A_2 u_{6,2} + \dots) \\ &= 2 \int_0^{\frac{\pi}{2}} (A_0 + A_1 \sin^2 x + A_2 \sin^4 x + \dots) dx \\ &= 2 \int_0^{\frac{\pi}{2}} F(\sin^2 x) dx = \int_0^{\pi} F(\sin^2 x) dx. \end{aligned}$$

1029. It is also plain that if $F(\sin \theta, \cos \theta)$ can be expressed in the form $A \sin p\theta + B \sin q\theta + C \sin r\theta + \dots$,

where $p, q, r \dots$ are all positive; then

$$\int_0^{\infty} \frac{F(\sin \theta, \cos \theta)}{\theta} d\theta = (A + B + C + \dots) \frac{\pi}{2},$$

or if $F(\sin \theta, \cos \theta)$ can be expressed as

$$A \cos p\theta + B \cos q\theta + C \cos r\theta + \dots,$$

where p, q, r are all positive, and if $A + B + C + \dots = 0$, then

$$\begin{aligned} \int_0^{\infty} \frac{F(\sin \theta, \cos \theta)}{\theta^2} d\theta &= \int_0^{\infty} \frac{A \cos p\theta + B \cos q\theta + \dots}{\theta^2} d\theta \\ &= \int_0^{\infty} \frac{A(\cos p\theta - 1) + B(\cos q\theta - 1) + \dots}{\theta^2} d\theta \\ &= -\frac{\pi}{2} (Ap + Bq + Cr + \dots), \end{aligned}$$

and evidently other propositions of similar kind may be enunciated.

1030. Ex. 1. Since $u_{2r+1,1} = \frac{1 \cdot 3 \cdot 5 \dots (2r-1)}{2 \cdot 4 \cdot 6 \dots 2r} \cdot \frac{\pi}{2}$, we have

$$\begin{aligned} & \int_0^\infty \log \frac{1+n \sin ax}{1-n \sin ax} \frac{dx}{x} \quad (n < 1, a > 0) \\ &= 2 \int_0^\infty \left(\frac{n}{1} \sin ax + \frac{n^3}{3} \sin^3 ax + \frac{n^5}{5} \sin^5 ax + \dots \right) \frac{dx}{x} \\ &= 2 \left[\frac{n}{1} \cdot \frac{\pi}{2} + \frac{n^3}{3} \cdot \frac{1}{2} \cdot \frac{\pi}{2} + \frac{n^5}{5} \cdot \frac{1 \cdot 3}{2 \cdot 4} \cdot \frac{\pi}{2} + \dots \right] = \pi \sin^{-1} n \quad (\text{Diff. Calc., p. 85}); \\ &\therefore \int_0^\infty \tanh^{-1}(n \sin ax) \frac{dx}{x} = \frac{\pi}{2} \sin^{-1} n; \end{aligned}$$

and if $n = \frac{1}{2}$, $\int_0^\infty \tanh^{-1}\left(\frac{1}{2} \sin ax\right) \frac{dx}{x} = \frac{\pi^2}{12}$.

Ex. 2. Since $u_{2r,2} = \frac{1 \cdot 3 \cdot 5 \dots (2r-3)}{2 \cdot 4 \cdot 6 \dots (2r-2)} \cdot \frac{\pi}{2}$ ($r > 2$),

$$\begin{aligned} & \int_0^\infty \log \frac{1+n \sin^2 ax}{1-n \sin^2 ax} \frac{dx}{x^2} \quad (n < 1, a > 0) \\ &= 2 \int_0^\infty \left(\frac{n}{1} \sin^2 ax + \frac{n^3}{3} \sin^6 ax + \frac{n^5}{5} \sin^{10} ax + \dots \right) \frac{dx}{x^2} \\ &= 2a \frac{\pi}{2} \left(n + \frac{n^3}{3} \frac{1 \cdot 3}{2 \cdot 4} + \frac{n^5}{5} \frac{1 \cdot 3 \cdot 5 \cdot 7}{2 \cdot 4 \cdot 6 \cdot 8} + \dots \right); \\ &\therefore \int_0^\infty \tanh^{-1}(n \sin^2 ax) \frac{dx}{x^2} = \frac{\pi a}{2} \{ \sqrt{1+n} - \sqrt{1-n} \}. \end{aligned}$$

Ex. 3. $I \equiv \int_{-\infty}^{\infty} \frac{\sin^2 x}{x^2} \tanh^{-1}\left(\cos \frac{\alpha}{2} \sin^2 x\right) dx$.

By Wolstenholme's principle given above, this integral

$$\begin{aligned} &= 2 \int_0^{\frac{\pi}{2}} \tanh^{-1}\left(\cos \frac{\alpha}{2} \sin^2 x\right) dx \\ &= 2 \int_0^{\frac{\pi}{2}} \left[\cos \frac{\alpha}{2} \sin^2 x + \frac{1}{3} \cos^3 \frac{\alpha}{2} \sin^6 x + \frac{1}{5} \cos^5 \frac{\alpha}{2} \sin^{10} x + \dots \right] dx \\ &= 2 \frac{\pi}{2} \left[\cos \frac{\alpha}{2} \frac{1}{2} + \frac{1}{3} \cos^3 \frac{\alpha}{2} \frac{5}{2} \frac{3}{6} \frac{1}{4} \frac{1}{2} + \frac{1}{5} \cos^5 \frac{\alpha}{2} \frac{9}{10} \frac{7}{8} \frac{5}{6} \frac{3}{4} \frac{1}{2} + \dots \right]. \end{aligned}$$

Now $\frac{(1-z)^{-\frac{1}{2}} - (1+z)^{-\frac{1}{2}}}{2z} = \frac{1}{2} + \frac{1 \cdot 3 \cdot 5}{2 \cdot 4 \cdot 6} z^2 + \frac{1 \cdot 3 \cdot 5 \cdot 7 \cdot 9}{2 \cdot 4 \cdot 6 \cdot 8 \cdot 10} z^4 + \dots$;

$\therefore \frac{1}{2} \int_0^{\frac{\pi}{2}} \left[\frac{1}{(1-z)^{\frac{1}{2}}} - \frac{1}{(1+z)^{\frac{1}{2}}} \right] \frac{dz}{z} = \frac{1}{2} z + \frac{1 \cdot 3 \cdot 5}{2 \cdot 4 \cdot 6} \frac{z^3}{3} + \frac{1 \cdot 3 \cdot 5 \cdot 7 \cdot 9}{2 \cdot 4 \cdot 6 \cdot 8 \cdot 10} \frac{z^5}{5} + \dots$;

and writing $z = \cos 2\theta$, this integral

$$\begin{aligned} &= -\frac{1}{2\sqrt{2}} \int_{\frac{\pi}{4}}^{\frac{3\pi}{4}} \left(\frac{1}{\sin \theta} - \frac{1}{\cos \theta} \right) \frac{4 \sin \theta \cos \theta}{\cos 2\theta} d\theta \\ &= \sqrt{2} \int_0^{\frac{\pi}{4}} \frac{d\theta}{\cos \theta + \sin \theta} = \log \cot \left(\frac{\theta}{2} + \frac{\pi}{8} \right). \end{aligned}$$

Hence putting $4\theta = \alpha$, $I = \pi \log \cot \frac{\pi + \alpha}{8}$.

1031. If p and q be positive integers and $p < q$, the integral $I = \int_0^\infty \frac{\sin^p x}{x^q} dx$ may be investigated by a method which does not entail the successive calculation of previous results of the same form leading up to this integral, as was done in Art. 1023.

Since
$$\int_0^\infty z^{q-1} e^{-zx} dz = \frac{\Gamma(q)}{x^q},$$

we have
$$\int_0^\infty \frac{\sin^p x}{x^q} dx = \frac{1}{(q-1)!} \int_0^\infty \int_0^\infty z^{q-1} e^{-zx} \sin^p x dz dx.$$

Now, p being taken greater than unity, and a positive

$$\int_0^\infty e^{-ax} \sin^p x dx = \frac{p(p-1)}{p^2 + a^2} \int_0^\infty e^{-ax} \sin^{p-2} x dx \quad (\text{Art. 104})$$

$$= \frac{p!}{(a^2 + p^2)(a^2 + (p-2)^2) \dots (a^2 + 2^2)} \frac{1}{a} \text{ if } p \text{ be even}$$

or
$$= \frac{p!}{(a^2 + p^2)(a^2 + (p-2)^2) \dots (a^2 + 1^2)} \text{ if } p \text{ be odd.}$$

Hence

$$\int_0^\infty \frac{\sin^p x}{x^q} dx = \frac{p!}{(q-1)!} \int_0^\infty \frac{z^{q-1} dz}{z(z^2 + 2^2)(z^2 + 4^2) \dots (z^2 + p^2)} \text{ if } p \text{ be even}$$

and
$$= \frac{p!}{(q-1)!} \int_0^\infty \frac{z^{q-1} dz}{(z^2 + 1^2)(z^2 + 3^2)(z^2 + 5^2) \dots (z^2 + p^2)} \text{ if } p \text{ be odd.}$$

The integrand can then be put into partial fractions of the form:

$$p \text{ even, } \sum_1^{\frac{p}{2}} \frac{A_{2k}}{z^2 + (2k)^2} \quad \text{or} \quad \sum_1^{\frac{p}{2}} \frac{A_{2k} z}{z^2 + (2k)^2}$$

(q even) (q odd);

$$p \text{ odd, } \sum_1^{\frac{p+1}{2}} \frac{B_{2k-1}}{z^2 + (2k-1)^2} \quad \text{or} \quad \sum_1^{\frac{p+1}{2}} \frac{B_{2k-1} z}{z^2 + (2k-1)^2}$$

(q odd) (q even);

and their coefficients have been found in Arts. 162 to 165.

In the two cases p even, } p odd, } the integrals are of the
 q even, } q odd, }

inverse tangent species, viz.

$$\int_0^\infty \frac{dz}{z^2 + n^2} = \left[\frac{1}{n} \tan^{-1} \frac{z}{n} \right]_0^\infty = \frac{1}{n} \frac{\pi}{2};$$

but in the remaining cases the integrals are logarithmic.

1032. Particular cases are simple.

$$\begin{aligned} \text{Thus } \int_0^\infty \frac{\sin^3 x}{x^3} dx &= \frac{3!}{2!} \int_0^\infty \frac{z^2 dz}{(z^2+1^2)(z^2+3^2)} = 3 \int_0^\infty \left[-\frac{1}{8} \frac{1}{z^2+1^2} + \frac{9}{8} \frac{1}{z^2+3^2} \right] dz \\ &= \frac{3}{8} \left[\frac{9}{3} \tan^{-1} \frac{z}{3} - \tan^{-1} z \right]_0^\infty = \frac{3}{8} \cdot \left(\frac{9}{3} - 1 \right) \frac{\pi}{2} = \frac{3\pi}{8}, \\ \int_0^\infty \frac{\sin^3 x}{x^2} dx &= \frac{3!}{1!} \int_0^\infty \frac{z dz}{(z^2+1^2)(z^2+3^2)} = 6 \int_0^\infty \left(\frac{1}{8} \frac{z}{z^2+1^2} - \frac{1}{8} \frac{z}{z^2+3^2} \right) dz \\ &= \frac{3}{4} \cdot \frac{1}{2} \left[\log \frac{z^2+1^2}{z^2+3^2} \right]_0^\infty = \frac{3}{8} \log 3^2 = \frac{3}{4} \log 3. \end{aligned}$$

1033. The general result is not difficult to obtain; the integrations have already been performed in Arts. 162, etc.

$$\int_0^\infty \frac{\sin^p x}{x^q} dx = \frac{p!}{(q-1)!} \int_0^\infty \frac{z^{q-2} dz}{(z^2+2^2)(z^2+4^2) \dots (z^2+p^2)} \quad \left(\begin{array}{l} p \text{ even,} \\ q \text{ even} \end{array} \right) \text{ and } p < q;$$

and by writing $q-2$ for $2q$ }
and p for $2n$ } in result (A) of Art. 162,

$$\int_0^\infty \frac{\sin^p x}{x^q} dx = \frac{(-1)^{\frac{p+q}{2}}}{(q-1)!} \frac{\pi}{2^p} \left[{}^p C_0 p^{q-1} - {}^p C_1 (p-2)^{q-1} + \dots + (-1)^{\frac{p}{2}-1} {}^p C_{\frac{p}{2}-1} 2^{q-1} \right] \dots (A)$$

And if p be odd }
and q be odd } and $p < q$,

$$\int_0^\infty \frac{\sin^p x}{x^q} dx = \frac{p!}{(q-1)!} \int_0^\infty \frac{z^{q-1} dz}{(z^2+1^2)(z^2+3^2) \dots (z^2+p^2)};$$

and writing $q-1$ for $2q$ }
and p for $2n-1$ } in result (C) of Art. 164, the integral

$$= \frac{(-1)^{\frac{q-p}{2}}}{(q-1)!} \frac{\pi}{2^p} \left[{}^p C_0 p^{q-1} - {}^p C_1 (p-2)^{q-1} + {}^p C_2 (p-4)^{q-1} - \dots + (-1)^{\frac{p}{2}} {}^p C_{\frac{p}{2}} 1^{q-1} \right]. \quad (B)$$

If p be even }
and q be odd } and $p < q$,

$$\int_0^\infty \frac{\sin^p x}{x^q} dx = \frac{p!}{(q-1)!} \int_0^\infty \frac{z^{q-2} z dz}{(z^2+2^2)(z^2+4^2) \dots (z^2+p^2)};$$

and writing $q-3$ for $2q$ }
and p for $2n$ } in result (B) of Art. 163, the indefinite integral is

$$\begin{aligned} \frac{1}{(q-1)!} \frac{(-1)^{\frac{p+q-1}{2}}}{2^p} \left[{}^p C_0 p^{q-1} \log(z^2+p^2) - {}^p C_1 (p-2)^{q-1} \log\{z^2+(p-2)^2\} + \dots \right. \\ \left. + (-1)^{\frac{p}{2}-1} {}^p C_{\frac{p}{2}-1} 2^{q-1} \log(z^2+2^2) \right]. \end{aligned}$$

Now in the expansion of $(e^x - e^{-x})^p \equiv (2x + \dots)^p = 2^p x^p + \dots$ there are no terms of lower degree than x^p . Hence, if q be $\nless p$, the coefficient of x^{q-1} is zero; i.e. the coefficient of x^{q-1} in

$$\begin{aligned} {}^p C_0 e^{px} - {}^p C_1 e^{(p-2)x} + {}^p C_2 e^{(p-4)x} - \dots + (-1)^{\frac{p}{2}-1} {}^p C_{\frac{p}{2}-1} e^{2x} + (-1)^{\frac{p}{2}} {}^p C_{\frac{p}{2}} \\ + (-1)^{\frac{p}{2}+1} {}^p C_{\frac{p}{2}+1} e^{-2x} + \dots + {}^p C_p e^{-px} \end{aligned}$$

is zero ; and p being even and q odd,

$${}^p C_0 p^{q-1} - {}^p C_1 (p-2)^{q-1} + {}^p C_2 (p-4)^{q-1} - \dots + (-1)^{\frac{p}{2}-1} {}^p C_{\frac{p}{2}-1} 2^{q-1}$$

vanishes identically. Hence, multiplying this expression by $\log z^2$, and subtracting it from the portion of the indefinite integral in square brackets, we have

$${}^p C_0 p^{q-1} \log \left(1 + \frac{p^2}{z^2} \right) - {}^p C_1 (p-2)^{q-1} \log \left\{ 1 + \frac{(p-2)^2}{z^2} \right\} + \dots + (-1)^{\frac{p}{2}-1} {}^p C_{\frac{p}{2}-1} 2^{q-1} \log \left(1 + \frac{2^2}{z^2} \right),$$

which vanishes when z is infinitely large.

Hence

$$\int_0^\infty \frac{\sin^p x}{x^q} dx = \frac{(-1)^{\frac{p+q+1}{2}}}{(q-1)!} \frac{1}{2^{p-1}} \left[{}^p C_0 p^{q-1} \log p - {}^p C_1 (p-2)^{q-1} \log (p-2) + {}^p C_2 (p-4)^{q-1} \log (p-4) - \dots + (-1)^{\frac{p}{2}-1} {}^p C_{\frac{p}{2}-1} 2^{q-1} \log 2 \right]. \dots (C)$$

Finally, if p be odd } and $p < q$,
and q be even }

$$\int_0^\infty \frac{\sin^p x}{x^q} dx = \frac{p!}{(q-1)!} \int_0^\infty \frac{z^{q-2} dz}{(z^2+1^2)(z^2+3^2)(z^2+5^2)\dots(z^2+p^2)};$$

and writing $q-1$ for $2q+1$ } in result (D) of Art. 165, the indefinite
and p for $2n-1$ }

$$\frac{1}{(q-1)!} \frac{(-1)^{\frac{q-p-1}{2}}}{2^p} \left[{}^p C_0 p^{q-1} \log (z^2+p^2) - {}^p C_1 (p-2)^{q-1} \log \{z^2+(p-2)^2\} + \dots + (-1)^{\frac{p-1}{2}} {}^p C_{\frac{p-1}{2}} 1^{q-1} \log (z^2+1^2) \right];$$

and in this case (p odd, q even) we have, in the same way as before,

$${}^p C_0 p^{q-1} - {}^p C_1 (p-2)^{q-1} + {}^p C_2 (p-4)^{q-1} - \dots + (-1)^{\frac{p-1}{2}} {}^p C_{\frac{p-1}{2}} 1^{q-1} \equiv 0,$$

an identity. Multiplying by $\log z^2$ and subtracting from the portion of the indefinite integral in square brackets, we get

$${}^p C_0 p^{q-1} \log \left(1 + \frac{p^2}{z^2} \right) - {}^p C_1 (p-2)^{q-1} \log \left\{ 1 + \frac{(p-2)^2}{z^2} \right\} + \dots + (-1)^{\frac{p-1}{2}} {}^p C_{\frac{p-1}{2}} 1^{q-1} \log \left(1 + \frac{1}{z^2} \right),$$

which vanishes when z is infinitely large.

Hence we get

$$\int_0^\infty \frac{\sin^p x}{x^q} dx = \frac{(-1)^{\frac{q-p+1}{2}}}{(q-1)!} \frac{1}{2^{p-1}} \left[{}^p C_0 p^{q-1} \log p - {}^p C_1 (p-2)^{q-1} \log (p-2) + \dots + (-1)^{\frac{p-1}{2}} {}^p C_{\frac{p-1}{2}} 1^{q-1} \log 1 \right], \dots (D)$$

the last term vanishing.

Hence, **summing up**, the four results may be written as

$$\int_0^{\infty} \frac{\sin^p x}{x^q} dx = \frac{(-1)^{\frac{p-q}{2}}}{(q-1)!} \frac{\pi}{2^p} \left[p^{q-1} - p(p-2)^{q-1} + \frac{p(p-1)}{1 \cdot 2} (p-4)^{q-1} - \dots \right]$$

to $\frac{p}{2}$ or $\frac{p+1}{2}$ terms, if $p-q$ be even, or as

$$= \frac{(-1)^{\frac{p-q-1}{2}}}{(q-1)!} \frac{1}{2^{p-1}} \left[p^{q-1} \log p - p(p-2)^{q-1} \log(p-2) \right. \\ \left. + \frac{p(p-1)}{1 \cdot 2} (p-4)^{q-1} \log(p-4) - \dots \right]$$

to $\frac{p}{2}$ or $\frac{p+1}{2}$ terms, if $p-q$ be odd; p being $\lessdot q$.

This generalisation is due to the late Prof. Wolstenholme.

It will be noticed that more is effected by the treatment of $\int_0^{\infty} \frac{\sin^p x}{x^q} dx$ in this article than in Art. 1023, as the limitation p, q , both even or both odd, is now avoided.

1034. Thus, for instance,

$$\int_0^{\infty} \frac{\sin^6 x}{x^4} dx = \frac{(-1)}{3!} \frac{\pi}{2^6} [6^3 - 6 \cdot 4^3 + 15 \cdot 2^3] = -\frac{\pi}{3 \cdot 2^7} (-48) = \frac{\pi}{2^3} = \frac{\pi}{8},$$

$$\int_0^{\infty} \frac{\sin^6 x}{x^5} dx = \frac{1}{3!} \frac{1}{2^4} \{5^3 \log 5 - 5 \cdot 3^3 \log 3\}.$$

EXAMPLES.

1. Show that

$$\int_0^{\infty} \frac{\sin x}{x} dx = \int_0^{\infty} \left(\frac{\sin x}{x} \right)^2 dx = 4 \int_0^{\infty} \left(\frac{\sin x}{x} \right)^3 dx = 3 \int_0^{\infty} \left(\frac{\sin x}{x} \right)^4 dx.$$

[MATH. TRIPOS, 1884.]

2. Prove that (1) $\int_0^{\infty} \frac{\sin^{2n+1} x}{x} dx = \frac{1 \cdot 3 \dots (2n-1)}{2 \cdot 4 \dots 2n} \cdot \frac{\pi}{2}$;

(2) $\int_0^{\infty} \frac{\sin^{2n+1} x}{x^3} dx = \frac{1 \cdot 3 \dots (2n-3)(2n+1)}{2 \cdot 4 \dots 2n} \cdot \frac{\pi}{4}$.

[TRINITY, 1889.]

3. Prove that $\int_0^{\infty} \frac{\sin x}{x} dx = \int_0^{\infty} \frac{\tan x}{x} dx = \frac{\pi}{2}$. [MATH. TRIPOS, 1887.]

4. Find the value of $\int_0^1 \left(\sin x + \sin \frac{1}{x} \right) \frac{dx}{x}$. [COLLEGES β , 1888.]

5. Trace the locus $y = \int_0^{\infty} \frac{\cos \theta \sin^3 \theta x}{\theta} d\theta$.

6. Describe the discontinuous surface $\frac{\pi z}{2} = \int_0^\infty \frac{\sin x\theta \cos y\theta}{\theta} d\theta$.

[TRINITY, 1888.]

7. Show that

$$\int_0^\infty \{ \phi 0 - x^2 \phi 1 + x^4 \phi 2 - \text{etc.} \} dx = \frac{1}{2} \pi \phi \left(-\frac{1}{2} \right),$$

and apply this theorem to find $\int_0^\infty \frac{\sin ax}{x} dx$.

[GLAISHER.]

8. Discuss the locus

$$y = \int_0^\infty \sin \frac{(2x - n + 1)\theta}{2} \sin \frac{n\theta}{2} \operatorname{cosec} \frac{\theta}{2} \frac{d\theta}{\theta}$$

where n is a positive integer.

9. If $0 < a < \pi$, prove that

$$(i) \int_0^\infty \log \frac{1 + \sin a \sin x}{1 - \sin a \sin x} \frac{dx}{x} = \pi a;$$

$$(ii) \int_0^\infty \log \frac{1 + \sin^2 a \sin^2 x}{1 - \sin^2 a \sin^2 x} \frac{dx}{x^2} = \pi (\sqrt{1 + \sin^2 a} - \cos a).$$

10. Prove that $\int_{-\infty}^\infty \frac{\sin^2 x \cos^2 x}{x^2(1 + \sin^2 x)} dx = \pi(\sqrt{2} - 1)$.

1035. Let $I_1 = \int e^{-ax} \cos bx dx$, $I_2 = \int e^{-ax} \sin bx dx$, ($a + \infty$).

Then $I_1 = e^{-ax} \frac{-a \cos bx + b \sin bx}{a^2 + b^2}$, and $[I_1]_0^\infty = \frac{a}{a^2 + b^2}$,

$I_2 = e^{-ax} \frac{-a \sin bx - b \cos bx}{a^2 + b^2}$, and $[I_2]_0^\infty = \frac{b}{a^2 + b^2}$.

Integrating each with regard to a , from $a=p$ to $a=q$,

$$\int_0^\infty \frac{e^{-qx} - e^{-px}}{x} \cos bx dx = \frac{1}{2} \log \frac{p^2 + b^2}{q^2 + b^2} \dots \dots \dots (1)$$

$$\int_0^\infty \frac{e^{-qx} - e^{-px}}{x} \sin bx dx = \tan^{-1} \frac{p}{b} - \tan^{-1} \frac{q}{b} \dots \dots \dots (2)$$

The case $\left. \begin{matrix} p = \infty \\ q = 0 \end{matrix} \right\}$ in (2) gives

$$\int_0^\infty \frac{\sin bx}{x} dx = \pm \frac{\pi}{2} \text{ as } b \text{ is } +\infty \text{ or } -\infty.$$

1036. Again starting with the same integrals, integrate with regard to b ; then

$$\int_0^{\infty} e^{-ax} \frac{\sin px - \sin qx}{x} dx = \tan^{-1} \frac{p}{a} - \tan^{-1} \frac{q}{a}, \dots \dots \dots (3)$$

$$\int_0^{\infty} e^{-ax} \frac{\cos px - \cos qx}{x} dx = \frac{1}{2} \log \frac{a^2 + q^2}{a^2 + p^2}. \dots \dots \dots (4)$$

Then

$$\int_0^{\infty} e^{-ax} \frac{\sin px}{x} dx = \tan^{-1} \frac{p}{a}; \quad \int_0^{\infty} e^{-ax} \frac{\text{vers } px}{x} dx = \frac{1}{2} \log \left(1 + \frac{p^2}{a^2} \right).$$

1037. Consider the Integral $I = \int_0^{\infty} e^{-x^2} \cos ax \, dx$.

(Laplace, *Mémoires de l'Institut*, 1809, p. 367.)

Differentiating with regard to a ,

$$\begin{aligned} \frac{dI}{da} &= - \int_0^{\infty} e^{-x^2} x \sin ax \, dx = \left[\frac{e^{-x^2}}{2} \sin ax \right]_0^{\infty} - \frac{a}{2} \int_0^{\infty} e^{-x^2} \cos ax \, dx \\ &= - \frac{a}{2} I; \end{aligned}$$

$\therefore I = A e^{-\frac{a^2}{4}}$ where A is independent of a . Putting $a=0$,

$$I_{a=0} = \int_0^{\infty} e^{-x^2} dx = \frac{\sqrt{\pi}}{2}; \quad \therefore A = \frac{\sqrt{\pi}}{2}. \quad \text{Hence } I = \frac{\sqrt{\pi}}{2} e^{-\frac{a^2}{4}}.$$

The proof is that of Legendre (*Exercices*, p. 362).

1038. Laplace established the result by aid of the integral

$$\int_0^{\infty} x^{2n} e^{-x^2} dx = \frac{1}{2} \Gamma \left(\frac{2n+1}{2} \right),$$

$$\begin{aligned} \text{viz. } I &= \int_0^{\infty} e^{-x^2} \left(1 - \frac{a^2 x^2}{2!} + \frac{a^4 x^4}{4!} - \dots \right) dx \\ &= \frac{\sqrt{\pi}}{2} \left(1 - \frac{a^2}{2!} \frac{1}{2} + \frac{a^4}{4!} \cdot \frac{1}{2 \cdot 2} - \dots \right) \\ &= \frac{\sqrt{\pi}}{2} \left(1 - \frac{a^2}{4} + \frac{1}{1 \cdot 2} \frac{a^4}{4^2} - \frac{1}{1 \cdot 2 \cdot 3} \frac{a^6}{4^3} + \dots \right) = \frac{\sqrt{\pi}}{2} e^{-\frac{a^2}{4}}. \end{aligned}$$

1039. Differentiating I n times with respect to a (*D.C.*, Art. 106),

$$\begin{aligned} \int_0^{\infty} e^{-x^2} x^n \cos \left(ax + \frac{n\pi}{2} \right) dx &= \frac{\sqrt{\pi}}{2} \frac{d^n}{da^n} \left(e^{-\frac{a^2}{4}} \right) \\ &= (-1)^n \frac{\sqrt{\pi}}{2} e^{-\frac{a^2}{4}} \left\{ \frac{(2a)^n}{4^n} - \frac{n(n-1)(2a)^{n-2}}{1! 4^{n-1}} + \frac{n(n-1)(n-2)(n-3)(2a)^{n-4}}{2! 4^{n-2}} - \dots \right\} \\ &= (-1)^n \frac{\sqrt{\pi}}{2^{n+1}} e^{-\frac{a^2}{4}} \left\{ a^n - \frac{n(n-1)}{1!} a^{n-2} + \frac{n(n-1)(n-2)(n-3)}{2!} a^{n-4} - \dots \right\}. \end{aligned}$$

1040. Integrating I with regard to a , from 0 to a ,

$$\int_0^{\infty} e^{-ax} \frac{\sin ax}{x} dx = \frac{\sqrt{\pi}}{2} \int_0^a e^{-a^2} da = \frac{\sqrt{\pi}}{2} \int_0^a \left(1 - \frac{a^2}{4} + \frac{1}{2!} \frac{a^4}{4^2} - \dots\right) da$$

$$= \frac{\sqrt{\pi}}{2} \left\{ a - \frac{a^3}{4 \cdot 3} + \frac{1}{2!} \frac{a^5}{4^2 \cdot 5} - \frac{1}{3!} \frac{a^7}{4^3 \cdot 7} + \dots \right\},$$

a rapidly converging series for small values of a , but not capable of summation by means of the known algebraic or trigonometric functions.

1041. Laplace's integral $I = \int_0^{\infty} e^{-ax^2} \cos 2bx dx = \frac{\sqrt{\pi}}{2a} e^{-\frac{b^2}{a}}$ follows immediately from the form of Art. 1037 by writing therein $\frac{2b}{a}$ for a and $x = ay$.

It should be noted that the process of differentiation in Art. 1037 is legitimate though the upper limit is infinite. (See remarks in Art. 356.)

For, taking the present form, the integrand $e^{-ax^2} \cos 2bx$ remains finite for all values of x . Change b to $b + \delta b$. Then

$$I + \delta I = \int_0^{\infty} e^{-ax^2} \cos 2(b + \delta b)x dx.$$

Hence

$$\frac{\delta I}{\delta b} = \int_0^{\infty} e^{-ax^2} \frac{\cos 2(b + \delta b)x - \cos 2bx}{\delta b} dx = \int_0^{\infty} e^{-ax^2} \{-2x \sin 2bx + \epsilon\} dx,$$

where ϵ is a finite quantity which vanishes in the limit when δb is made infinitesimally small,

$$i.e. \quad \frac{\delta I}{\delta b} = -2 \int_0^{\infty} x e^{-ax^2} \sin 2bx dx + \int_0^{\infty} \epsilon \cdot e^{-ax^2} dx.$$

If ϵ_1 be the greatest numerical value of ϵ in the range of values of x from 0 to ∞ , the second term is numerically $< \epsilon_1 \int_0^{\infty} e^{-ax^2} dx$, i.e. $< \epsilon_1 \frac{\sqrt{\pi}}{2a}$, and therefore vanishes in the limit when ϵ is infinitesimally small.

The process of differentiation is therefore justifiable.

$$\text{Proceeding as before,} \quad \frac{dI}{db} = -\frac{2b}{a^2} I, \quad I = A e^{-\frac{b^2}{a}};$$

$$\text{and putting } b=0, \quad I = \int_0^{\infty} e^{-ax^2} dx = \frac{\sqrt{\pi}}{2a}; \quad \therefore A = \frac{\sqrt{\pi}}{2a},$$

$$\text{and} \quad I = \frac{\sqrt{\pi}}{2a} e^{-\frac{b^2}{a}}.$$

EXAMPLES.

1. Show that

$$\int_0^{\infty} x e^{-x^2} \sin ax \, dx = \frac{\sqrt{\pi}}{4} e^{-\frac{a^2}{4}} a,$$

$$\int_0^{\infty} x^2 e^{-x^2} \cos ax \, dx = \frac{\sqrt{\pi}}{4} e^{-\frac{a^2}{4}} \left(1 - \frac{a^2}{2}\right),$$

$$\int_0^{\infty} x^3 e^{-x^2} \sin ax \, dx = \frac{\sqrt{\pi}}{8} e^{-\frac{a^2}{4}} \left(3a - \frac{a^3}{2}\right),$$

$$\int_0^{\infty} x^4 e^{-x^2} \cos ax \, dx = \frac{\sqrt{\pi}}{8} e^{-\frac{a^2}{4}} \left(3 - 3a^2 + \frac{a^4}{4}\right),$$

$$\int_0^{\infty} x^5 e^{-x^2} \sin ax \, dx = \frac{\sqrt{\pi}}{16} e^{-\frac{a^2}{4}} \left(15a - 5a^3 + \frac{a^5}{4}\right),$$

and show that we can calculate

$$\int_0^{\infty} [\phi(x^2) \cos ax + \psi(x^2)x \sin ax] e^{-x^2} \, dx$$

when $\phi(x^2)$ and $\psi(x^2)$ are rational integral functions of x^2 .[LEGENRE, *Exercices*, p. 363.]2. Show that if $I = \int_0^{\infty} e^{-x^2} \sin ax \, dx$, then

$$I = \frac{1}{2} e^{-\frac{a^2}{4}} \int_0^a e^{\frac{a^2}{4} - a^2} da = \frac{1}{2} \left(a - \frac{a^3}{2 \cdot 3} + \frac{a^5}{3 \cdot 4 \cdot 5} - \frac{a^7}{4 \cdot 5 \cdot 6 \cdot 7} + \dots \right).$$

[LEGENRE, *ibid.*]3. If $I = \frac{1}{2} e^{-\frac{a^2}{4}} \int_0^a e^{\frac{a^2}{4} - a^2} da$, prove that

$$\int_0^{\infty} e^{-x^2} x \cos ax \, dx = \frac{1}{2} - \frac{1}{2} a I,$$

$$\int_0^{\infty} e^{-x^2} x^2 \sin ax \, dx = \frac{1}{4} a + \frac{1}{2} I \left(1 - \frac{a^2}{2}\right),$$

$$\int_0^{\infty} e^{-x^2} x^3 \cos ax \, dx = \frac{1}{2} - \frac{a^2}{8} - \frac{1}{4} I \left(3a - \frac{a^3}{2}\right),$$

$$\int_0^{\infty} e^{-x^2} x^4 \sin ax \, dx = \frac{5}{8} a - \frac{a^3}{16} + \frac{1}{4} I \left(3 - 3a^2 + \frac{a^4}{4}\right),$$

etc.

[LEGENRE, *ibid.*]

4. Show that

$$(i) \int_0^{\infty} e^{-x^2} \left(\frac{1}{2} a \sin ax + x \cos ax\right) dx = \frac{1}{2};$$

$$(ii) \int_0^{\infty} e^{-x^2} \left(1 - \frac{1}{2} a^2 - 2x^2\right) \sin ax \, dx = -\frac{1}{2} a.$$

[LEGENRE, *ibid.*]

1042. The Integral $I \equiv \int_0^\infty \frac{dx}{(a^2+x^2)(b^2+x^2)} = \frac{\pi}{2} \frac{1}{ab(a+b)}$ is useful in a certain class of Definite Integrals, (a and b both +ve).

Since $\frac{1}{(a^2+x^2)(b^2+x^2)} = \frac{1}{b^2-a^2} \left(\frac{1}{a^2+x^2} - \frac{1}{b^2+x^2} \right)$, we have

$$I \equiv \frac{1}{b^2-a^2} \left[\frac{1}{a} \tan^{-1} \frac{x}{a} - \frac{1}{b} \tan^{-1} \frac{x}{b} \right]_0^\infty = \frac{1}{b^2-a^2} \left(\frac{1}{a} - \frac{1}{b} \right) \frac{\pi}{2} = \frac{\pi}{2} \frac{1}{ab(a+b)}.$$

Thus, if
$$u = \int_0^\infty \frac{\tan^{-1} \frac{x}{a}}{x(b^2+x^2)} dx, \quad (a, b \text{ both } +ve),$$

$$\frac{du}{da} = - \int_0^\infty \frac{dx}{(a^2+x^2)(b^2+x^2)} = - \frac{\pi}{2} \frac{1}{ab(a+b)} = - \frac{\pi}{2b^2} \left(\frac{1}{a+b} - \frac{1}{a} \right);$$

$$\therefore u = \frac{\pi}{2b^2} \log \frac{a+b}{a} + A,$$

where A is independent of a . But when $a = \infty, u = 0; \therefore A = 0;$

$$\therefore \int_0^\infty \frac{\tan^{-1} \frac{x}{a}}{x(b^2+x^2)} dx = \frac{\pi}{2b^2} \log \left(1 + \frac{b}{a} \right). \dots\dots\dots(1)$$

Putting $x = b \tan \theta$, we have
$$\int_0^{\frac{\pi}{2}} \frac{\tan^{-1} \left(\frac{b}{a} \tan \theta \right)}{\tan \theta} d\theta = \frac{\pi}{2} \log \left(1 + \frac{b}{a} \right),$$

or writing c for $\frac{b}{a}, \int_0^{\frac{\pi}{2}} \cot \theta \tan^{-1}(c \tan \theta) d\theta = \frac{\pi}{2} \log(1+c). \dots\dots\dots(2)$

The particular case $c = 1$ gives
$$\int_0^{\frac{\pi}{2}} \theta \cot \theta d\theta = \frac{\pi}{2} \log 2. \dots\dots\dots(3)$$

Integrating by parts,
$$[\theta \log \sin \theta]_0^{\frac{\pi}{2}} - \int_0^{\frac{\pi}{2}} \log \sin \theta d\theta = \frac{\pi}{2} \log 2,$$

or
$$\int_0^{\frac{\pi}{2}} \log \sin \theta d\theta = \frac{\pi}{2} \log \frac{1}{2}, \dots\dots\dots(4)$$

as in Art. 990.

1043. The Integral $I = \int_0^b \frac{\tan^{-1} \frac{x}{a}}{x\sqrt{b^2-x^2}} dx, (b > a)$, is of similar form,

but best evaluated by expansion. Put $x = b \sin \theta$.

$$\begin{aligned} I &= \int_0^{\frac{\pi}{2}} \frac{\tan^{-1} \left(\frac{b}{a} \sin \theta \right)}{b \sin \theta} d\theta = \frac{1}{a} \int_0^{\frac{\pi}{2}} \left(1 - \frac{b^2 \sin^2 \theta}{a^2} + \frac{b^4 \sin^4 \theta}{a^4} - \dots \right) d\theta \\ &= \frac{\pi}{2b} \left(\frac{b}{a} - \frac{1}{2} \cdot \frac{1}{3} \frac{b^3}{a^3} + \frac{1.3}{2.4} \cdot \frac{1}{5} \frac{b^5}{a^5} - \dots \right) = \frac{\pi}{2b} \sinh^{-1} \left(\frac{b}{a} \right), \end{aligned}$$

i.e.
$$\int_0^{\frac{\pi}{2}} \operatorname{cosec} \theta \tan^{-1}(c \sin \theta) d\theta = \frac{\pi}{2} \sinh^{-1} c = \frac{\pi}{2} \log(c + \sqrt{1+c^2}),$$

or, for the case $c=1$,

$$\int_0^{\frac{\pi}{2}} \frac{\tan^{-1}(\sin \theta)}{\sin \theta} d\theta = \frac{\pi}{2} \log(1 + \sqrt{2}).$$

1044. Let $I \equiv \int_0^{\infty} \frac{\log(1+a^2x^2)}{b^2+x^2} dx$. Then $\frac{dI}{da} = \int_0^{\infty} \frac{2ax^2}{(1+a^2x^2)(b^2+x^2)} dx$

$$= \frac{2}{1-a^2b^2} \int_0^{\infty} \left(\frac{1}{a} \cdot \frac{1}{1+x^2} - ab^2 \frac{1}{b^2+x^2} \right) dx = \frac{2}{1-a^2b^2} \frac{\pi}{2} [1-ab] = \frac{\pi}{1+ab},$$

(a, b each being taken $+$ “).

Hence $I = \frac{\pi}{b} \log(1+ab) + A$, where A is independent of a . Also $I=0$ if $a=0$; $\therefore A=0$;

$$\therefore \int_0^{\infty} \frac{\log(1+a^2x^2)}{b^2+x^2} dx = \frac{\pi}{b} \log(1+ab).$$

It follows that $\int_0^{\infty} \frac{\log(c^2+x^2)}{b^2+x^2} dx = \int_0^{\infty} \frac{\log c^2}{b^2+x^2} dx + \int_0^{\infty} \frac{\log(1+\frac{x^2}{c^2})}{b^2+x^2} dx$

$$= \frac{\log c^2}{b} \cdot \frac{\pi}{2} + \frac{\pi}{b} \log\left(1+\frac{b}{c}\right) = \frac{\pi}{b} \log(c+b),$$

(b, c each $+$ “).

And writing $x=b \tan \theta$,

$$\int_0^{\frac{\pi}{2}} \log(c^2+b^2 \tan^2 \theta) d\theta = \pi \log(b+c); \text{ and adding } \int_0^{\frac{\pi}{2}} \log \cos^2 \theta d\theta = \pi \log \frac{1}{2},$$

$$\therefore \int_0^{\frac{\pi}{2}} \log(b^2 \sin^2 \theta + c^2 \cos^2 \theta) d\theta = \pi \log \frac{b+c}{2}, \quad (b, c +\text{“}).$$

1045. Again, taking the expression for $\frac{\tan x}{x}$ in partial fractions (logarithmic differential of $\cos x$ expressed in factors), viz.

$$\frac{\tan x}{x} = \sum_1^{\infty} \frac{2 \cdot 2^2}{(2r-1)^2 \pi^2 - 2^2 x^2},$$

put $x = \pi k z i$; then

$$\frac{\pi \tanh \pi k z}{k z} = \sum_1^{\infty} \frac{2 \cdot 2^2}{(2r-1)^2 + 2^2 k^2 z^2},$$

and $\frac{\pi}{k} \int_0^{\infty} \frac{\tanh \pi k z}{(a^2+z^2) z} dz = \sum_1^{\infty} \int_0^{\infty} \frac{2 dz}{k^2 (a^2+z^2) \left\{ \left(\frac{2r-1}{2k} \right)^2 + z^2 \right\}}$

$$= \sum_1^{\infty} \frac{2}{k^2} \frac{\pi}{2a \cdot \frac{2r-1}{2k} \left(a + \frac{2r-1}{2k} \right)},$$

and $\int_0^{\infty} \frac{\tanh \pi k z}{(a^2+z^2) z} dz = \frac{4k}{a} \sum_1^{\infty} \frac{1}{(2r-1)(2ka+2r-1)}.$

Thus, in the case $a=k=1$,

$$\begin{aligned} \int_0^\infty \frac{\tanh \pi z}{(1+z^2)} \frac{dz}{z} &= 4 \left[\frac{1}{1 \cdot 3} + \frac{1}{3 \cdot 5} + \frac{1}{5 \cdot 7} + \dots \text{ad. inf.} \right] \\ &= 2 \left[\frac{1}{1} - \frac{1}{3} + \frac{1}{3} - \frac{1}{5} + \frac{1}{5} - \frac{1}{7} + \dots \right] = 2, \end{aligned}$$

or taking $a=1$ and k any positive integer,

$$\begin{aligned} \int_0^\infty \frac{\tanh k\pi z}{(1+z^2)} \frac{dz}{z} &= 4k \left[\frac{1}{1 \cdot (2k+1)} + \frac{1}{3(2k+3)} + \frac{1}{5(2k+5)} + \dots \right] \\ &= 2 \left[\left(\frac{1}{1} - \frac{1}{2k+1} \right) + \left(\frac{1}{3} - \frac{1}{2k+3} \right) + \dots + \left(\frac{1}{2k+1} - \frac{1}{4k+1} \right) + \dots \right] \\ &= 2 \left(\frac{1}{1} + \frac{1}{3} + \frac{1}{5} + \dots + \frac{1}{2k-1} \right), \end{aligned}$$

and if a, k be any two positive integers, the series will terminate as in the last case.

$$\begin{aligned} \int_0^\infty \frac{\tanh k\pi z}{(a^2+z^2)} \frac{dz}{z} &= \frac{4k}{a} \frac{1}{2ka} \Sigma \left(\frac{1}{2r-1} - \frac{1}{2ka+2r-1} \right) \\ &= \frac{2}{a^2} \left[\left(\frac{1}{1} - \frac{1}{2ka+1} \right) + \left(\frac{1}{3} - \frac{1}{2ka+3} \right) + \dots + \left(\frac{1}{2ka+1} - \frac{1}{4ka+1} \right) + \dots \right] \\ &= \frac{2}{a^2} \left[1 + \frac{1}{3} + \frac{1}{5} + \dots + \frac{1}{2ka-1} \right]. \end{aligned}$$

If $k = \frac{1}{2}$ and a an even number, the series will also terminate.

Thus
$$\int_0^\infty \frac{\tanh \frac{\pi z}{2}}{(a^2+z^2)} \frac{dz}{z} = \frac{2}{a^2} \Sigma \left(\frac{1}{2r-1} - \frac{1}{a+2r-1} \right).$$

If $a = 2n$, this becomes

$$\begin{aligned} \int_0^\infty \frac{\tanh \frac{\pi z}{2}}{\{(2n)^2+z^2\}} \frac{dz}{z} &= \frac{2}{4n^2} \left[\left(\frac{1}{1} - \frac{1}{2n+1} \right) + \left(\frac{1}{3} - \frac{1}{2n+3} \right) + \dots \right] \\ &= \frac{1}{2n^2} \left(1 + \frac{1}{3} + \dots + \frac{1}{2n-1} \right). \end{aligned}$$

But if a be odd, $= 2n+1$, the series does not terminate.

$$\begin{aligned} \int_0^\infty \frac{\tanh \frac{\pi z}{2}}{\{(2n+1)^2+z^2\}} \frac{dz}{z} &= \frac{2}{(2n+1)^2} \left\{ \left(\frac{1}{1} - \frac{1}{2n+2} \right) + \left(\frac{1}{3} - \frac{1}{2n+4} \right) + \dots \right\} \\ &= \frac{2}{(2n+1)^2} \left[\log 2 + \frac{1}{2} + \frac{1}{4} + \dots + \frac{1}{2n} \right] \\ &= \frac{1}{(2n+1)^2} \left[\log 4 + \frac{1}{1} + \frac{1}{2} + \frac{1}{3} + \dots + \frac{1}{n} \right]. \end{aligned}$$

Similarly if $2k$ be any odd number $= 2p+1$, i.e. $k = \frac{2p+1}{2}$,

$$\int_0^\infty \frac{\tanh \frac{2p+1}{2} \pi z}{(a^2+z^2)} \frac{dz}{z} = \frac{2}{a^2} \Sigma \left(\frac{1}{2r-1} - \frac{1}{(2p+1)a+2r-1} \right),$$

and this will terminate, or will not terminate, according as a is even or odd.

If a be even, $=2n$, the result is

$$\begin{aligned} &= \frac{1}{2n^2} \left[\left(\frac{1}{1} - \frac{1}{2n(2p+1)+1} \right) + \left(\frac{1}{3} - \frac{1}{2n(2p+1)+3} \right) + \dots \right] \\ &= \frac{1}{2n^2} \left\{ \frac{1}{1} + \frac{1}{3} + \dots + \frac{1}{2n(2p+1)-1} \right\}. \end{aligned}$$

If a be odd, $=2n+1$, the result is

$$= \frac{2}{(2n+1)^2} \left[\log 2 + \frac{1}{2} + \frac{1}{4} + \frac{1}{6} + \dots + \frac{1}{(2n+1)(2p+1)-1} \right].$$

1046. Let
$$I \equiv \int_0^{\infty} e^{-c^2(x^2+\frac{a^2}{x^2})} dx. \quad (a+ve).$$

[Laplace, *Mém. de l'Inst.*, 1820, for the case $c=1$.]

The integrand is finite for the whole range of integration. Change a to $a+\delta a$.

Then
$$I + \delta I = \int_0^{\infty} e^{-c^2 \left\{ x^2 + \frac{(a+\delta a)^2}{x^2} \right\}} dx.$$

Hence
$$\frac{\delta I}{\delta a} = \int_0^{\infty} e^{-c^2 x^2} \left\{ e^{-\frac{a^2 c^2}{x^2}} \left(-\frac{2c^2 a}{x^2} \right) + \epsilon \right\} dx,$$

where ϵ becomes infinitesimally small and ultimately vanishes when δa is indefinitely diminished.

$$\therefore \frac{\delta I}{\delta a} = -2c^2 a \int_0^{\infty} \frac{1}{x^2} e^{-c^2(x^2+\frac{a^2}{x^2})} dx + \int_0^{\infty} \epsilon \cdot e^{-c^2 x^2} dx.$$

Let ϵ_1 be the greatest numerical value of ϵ in the range of x .

Then the second term is $< \epsilon_1 \int_0^{\infty} e^{-c^2 x^2} dx$; i.e. $< \epsilon_1 \cdot \frac{\sqrt{\pi}}{2c}$, and ultimately vanishes with δa .

Hence the process of differentiation with regard to a under the integration sign with an infinite limit is justifiable.

In the first put $x=a/y$.

Then

$$\frac{dI}{da} = 2c^2 \int_{\infty}^0 e^{-c^2 \left(\frac{a^2}{y^2} + y^2 \right)} dy = -2c^2 I; \quad \therefore I = Ae^{-2c^2 a},$$

where A is independent of a .

But when $a=0$,

$$I_{a=0} = \int_0^{\infty} e^{-c^2 x^2} dx = \frac{\sqrt{\pi}}{2c}; \quad \therefore A = \frac{\sqrt{\pi}}{2c}, \quad c \text{ being supposed } +ve.$$

Hence

$$I \equiv \int_0^\infty e^{-c^2(x^2 + \frac{a^2}{x^2})} dx = \frac{\sqrt{\pi}}{2c} e^{-2c^2 a} \left(\text{or } -\frac{\sqrt{\pi}}{2c} e^{-2c^2 a} \text{ if } c \text{ be } -ve \right).$$

Laplace's form, viz. the case $c=1$, gives

$$\int_0^\infty e^{-x^2 - \frac{a^2}{x^2}} dx = \frac{\sqrt{\pi}}{2} e^{-2a}, \quad (a + ve).$$

If we replace a^2 by $b^2 a^2$ and c^2 by $\frac{k}{a^2}$, we have the form

$$\int_0^\infty e^{-k \left(\frac{x^2}{a^2} + \frac{b^2}{x^2} \right)} dx = \frac{\sqrt{\pi}}{2} \cdot \frac{a}{\sqrt{k}} e^{-2k \frac{b}{a}}, \dots\dots\dots(1)$$

where a, b, k are positive.

This result may be written

$$\int_0^\infty e^{-k \left(\frac{x}{a} - \frac{b}{x} \right)^2} dx = \frac{a}{2} \sqrt{\frac{\pi}{k}} \dots\dots\dots(2)$$

1047. Cor. 1. If $k=1$ and $a=b$, we have

$$I_1 \equiv \int_0^\infty e^{-\left(\frac{x^2}{a^2} + \frac{a^2}{x^2} \right)} dx = \frac{\sqrt{\pi}}{2} a e^{-2} \dots\dots\dots(3)$$

Cor. 2. If we differentiate I_1 with respect to a , we have

$$\frac{dI_1}{da} \equiv \int_0^\infty \left(\frac{2x^2}{a^3} - \frac{2a}{x^2} \right) e^{-\left(\frac{x^2}{a^2} + \frac{a^2}{x^2} \right)} dx = \frac{\sqrt{\pi}}{2} e^{-2},$$

i.e. $\int_0^\infty \left(\frac{x^2}{a^2} - \frac{a^2}{x^2} \right) e^{-\left(\frac{x^2}{a^2} + \frac{a^2}{x^2} \right)} dx = \frac{1}{2} \sqrt{\pi} a e^{-2} \dots\dots\dots(4)$

Differentiating (1) with regard to k , and then putting $k=1$ and $a=b$,

$$\int_0^\infty \left(\frac{x^2}{a^2} + \frac{a^2}{x^2} \right) e^{-\left(\frac{x^2}{a^2} + \frac{a^2}{x^2} \right)} dx = \frac{1}{2} \sqrt{\pi} a e^{-2} \dots\dots\dots(5)$$

(4) and (5) give

$$\int_0^\infty \frac{x^2}{a^2} e^{-\left(\frac{x^2}{a^2} + \frac{a^2}{x^2} \right)} dx = \frac{3}{4} \sqrt{\pi} a e^{-2}, \dots\dots(6) \quad \int_0^\infty \frac{a^2}{x^2} e^{-\left(\frac{x^2}{a^2} + \frac{a^2}{x^2} \right)} dx = \frac{1}{4} \sqrt{\pi} a e^{-2}, \dots\dots(7)$$

Cor. 3. We also have

$$\int_0^\infty e^{-k \frac{x^2}{a^2}} \left(e^{-k \frac{b_1^2}{x^2}} - e^{-k \frac{b_2^2}{x^2}} \right) dx = \frac{\sqrt{\pi} a}{2\sqrt{k}} \left(e^{-2k \frac{b_1}{a}} - e^{-2k \frac{b_2}{a}} \right),$$

and making a indefinitely large,

$$\int_0^\infty \left(e^{-k \frac{b_1^2}{x^2}} - e^{-k \frac{b_2^2}{x^2}} \right) dx = \frac{\sqrt{\pi}}{2\sqrt{k}} \cdot 2k(b_2 - b_1) = \sqrt{\pi k}(b_2 - b_1) \dots\dots\dots(8)$$

1048. Let $I = \int_0^{\infty} \frac{\cos rx}{a^2 + x^2} dx$ (a positive).

We have $\int_0^{\infty} 2ze^{-(a^2+x^2)z^2} dz = \frac{1}{a^2+x^2}$.

Then

$$\begin{aligned} I &= \int_0^{\infty} \int_0^{\infty} \cos rx \cdot 2ze^{-(a^2+x^2)z^2} dx dz \\ &= \int_0^{\infty} 2ze^{-a^2z^2} \left(\int_0^{\infty} e^{-x^2z^2} \cos rx dx \right) dz \\ &= \int_0^{\infty} 2ze^{-a^2z^2} \left(\frac{\sqrt{\pi}}{2z} e^{-\frac{r^2}{4z^2}} \right) dz = \sqrt{\pi} \int_0^{\infty} e^{-(a^2z^2 + \frac{r^2}{4z^2})} dz \\ &= \sqrt{\pi} \cdot \frac{\sqrt{\pi}}{2a} e^{-ar} \text{ or } \sqrt{\pi} \frac{\sqrt{\pi}}{2a} e^{+ar}, \text{ as } r \text{ is positive or negative.} \end{aligned}$$

$\therefore I = \int_0^{\infty} \frac{\cos rx}{a^2+x^2} dx = \frac{\pi}{2a} e^{-ar}$ or $\frac{\pi}{2a} e^{ar}$, as r is positive or negative.

This integral is more commonly written as

$$\int_0^{\infty} \frac{\cos rx}{1+x^2} dx = \frac{\pi}{2} e^{-r} \text{ or } \frac{\pi}{2} e^r, \text{ as } r \text{ is positive or negative.}$$

This result is due to Laplace (*Bulletin de la Soc. Phil.* 1811).

1049. Both results may be expressed in one as

$$\int_0^{\infty} \frac{\cos rx}{1+x^2} dx = \frac{\pi}{2} \left\{ \frac{e^r}{1+0^{-r}} + \frac{e^{-r}}{1+0^r} \right\},$$

for 0^r is zero or infinite according as r is positive or negative.

This form was given in Crelle's *Journal*, vol. x., and is due to Libri. (See Gregory's *Examples*, p. 486.)

1050. Differentiating with regard to r , we obtain the integral ($a + re$)

$$\int_0^{\infty} \frac{x \sin rx}{a^2+x^2} dx = \frac{\pi}{2} e^{-ar} \text{ or } -\frac{\pi}{2} e^{ar}, \text{ as } r \text{ is positive or negative.}$$

This integral vanishes if $r=0$.

The differentiation under the integral sign may be shown to be justifiable, although the upper limit is infinite, in the same manner as in previous cases.

1051. If we integrate with respect to r between limits r_1 and r_2 (both positive),

$$\int_0^{\infty} \frac{\sin r_2 x - \sin r_1 x}{x(a^2+x^2)} dx = \frac{\pi}{2a^2} (e^{-ar_1} - e^{-ar_2}).$$

If $r_1=0$, we have

$$\int_0^{\infty} \frac{\sin rx}{x(a^2+x^2)} dx = \frac{\pi}{2a^2}(1-e^{-ar}),$$

a result given by Laplace (*Mémoires de l'Académie*, 1782).

If we write $x = \tan \theta$ in the integral

$$\int_0^{\infty} \frac{\cos rx}{1+x^2} dx = \frac{\pi}{2} e^{-r} \text{ or } \frac{\pi}{2} e^r,$$

we have $\int_0^{\frac{\pi}{2}} \cos(r \tan \theta) d\theta = \frac{\pi}{2} e^{-r} \text{ or } \frac{\pi}{2} e^r,$

according as r is positive or negative.

1052. Graphical Illustrations.

Graph of $y = \frac{2}{\pi} \int_0^x \frac{\cos x\theta}{1+\theta^2} d\theta.$

We have $y = e^{-x}$ or $y = e^x$, according as x is positive or negative, the y -axis being an axis of symmetry.

The logarithmic curve is traced in *Diff. Calc.*, Art. 442.

The graph now required consists of the two portions of the above curves which run asymptotically to the x -axis from their point of intersection upon the y -axis (Fig. 332).

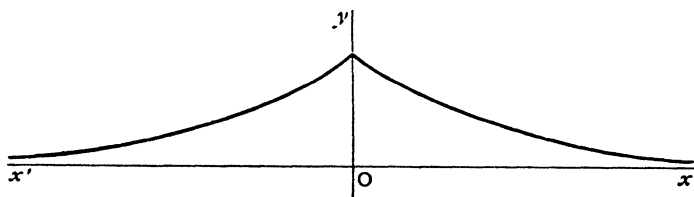

Fig. 332.

1053. Graph of $y = \frac{2}{\pi} \int_0^x \frac{\cos x\theta \cos a\theta}{1+\theta^2} d\theta.$

The y axis is again an axis of symmetry,

$$y = \frac{1}{\pi} \int_0^{\infty} \frac{\cos(x+a)\theta}{1+\theta^2} d\theta + \frac{1}{\pi} \int_0^{\infty} \frac{\cos(x-a)\theta}{1+\theta^2} d\theta.$$

If a be regarded as a positive constant and $x > a$, we have

$$y = \frac{1}{\pi} \left[\frac{\pi}{2} e^{-(x+a)} + \frac{\pi}{2} e^{-(x-a)} \right] = \cosh a \cdot e^{-x}.$$

If $a > x > 0$, we have

$$y = \frac{1}{\pi} \left[\frac{\pi}{2} e^{-(x+a)} + \frac{\pi}{2} e^{(x-a)} \right] = \cosh x \cdot e^{-a}.$$

The graph therefore consists of a portion of a catenary from $x=0$ to $x=a$

and a portion of the logarithmic curve from $x=a$ to $x=\infty$, with the image with regard to the y -axis of these portions (Fig. 333).

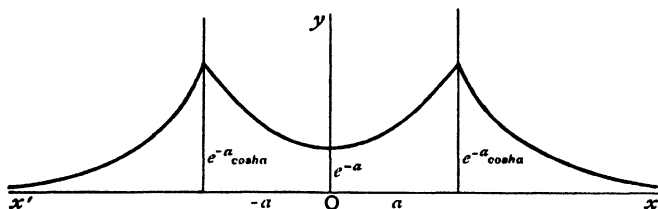

Fig. 333.

1054. Graph of
$$\frac{\pi y}{2a} = \int_0^\infty \frac{\cos\left(\theta \log \frac{a^2}{x^2}\right)}{1 + \theta^2} d\theta.$$

Here, if $x < a$,
$$\frac{\pi y}{2a} = \frac{\pi}{2} e^{-\log \frac{a^2}{x^2}} = \frac{\pi}{2} e^{\log \frac{x^2}{a^2}} = \frac{\pi x^2}{2 a^2},$$

i.e. $x^2 = ay$, a parabola;

if $x > a$,
$$\frac{\pi y}{2a} = \frac{\pi}{2} e^{\log \frac{a^2}{x^2}} = \frac{\pi a^2}{2 x^2},$$

$$x^2 y = a^3,$$

and the y -axis is obviously an axis of symmetry (Fig. 334).

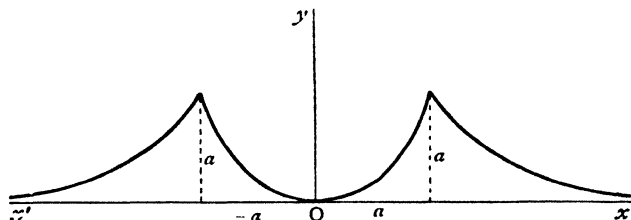

Fig. 334.

1055. Graph of
$$\frac{\pi y}{2a} = \int_0^\infty \frac{\cos\left(\theta \log \sin^2 \frac{x}{a}\right)}{1 + \theta^2} d\theta.$$

$\log \sin^2 \frac{x}{a}$ is negative. Hence

$$\frac{\pi y}{2a} = \frac{\pi}{2} e^{\log \sin^2 \frac{x}{a}} = \frac{\pi}{2} \sin^2 \frac{x}{a} \quad \text{and} \quad y = a \sin^2 \frac{x}{a} \quad (\text{Fig. 335}).$$

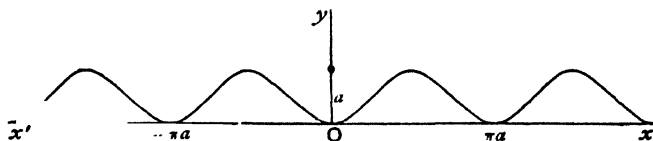

Fig. 335.

1056. Another mode of discussing the integrals of Arts. 1048 to 1051 is as follows :

$$\text{Let } u = \int_0^{\infty} \frac{\sin rx}{x(a^2+x^2)} dx, \quad (a \text{ positive}).$$

$$\text{Then } \frac{du}{dr} = \int_0^{\infty} \frac{\cos rx}{a^2+x^2} dx, \quad \frac{d^2u}{dr^2} = - \int_0^{\infty} \frac{x \sin rx}{a^2+x^2} dx;$$

$$\therefore \frac{d^2u}{dr^2} - a^2u = - \int_0^{\infty} \left(x + \frac{a^2}{x}\right) \frac{\sin rx}{a^2+x^2} dx = - \int_0^{\infty} \frac{\sin rx}{x} dx$$

$$= -\pi/2, 0 \text{ or } +\pi/2, \text{ as } r \text{ is } +ve, \text{ zero or } -ve;$$

$$\therefore u = \pi/2a^2 + Ae^{-ar} + Be^{ar} \text{ for any positive value of } r$$

(I.C. for Beginners, p. 250),

where A and B are constants as regards r .

But u is finite when r is infinite; $\therefore B=0$. Also there is obviously no discontinuity in the value of $\frac{du}{dr}$, which is also finite for all values of r , as r diminishes through the value zero and becomes negative; for a small negative value of r gives the same value to $\int_0^{\infty} \frac{\cos rx}{a^2+x^2} dx$ as an equal small positive value, and when r is zero the value is $\int_0^{\infty} \frac{dx}{a^2+x^2}$, i.e. $\frac{\pi}{2a}$.

Therefore $-Aa = \pi/2a$ and $A = -\pi/2a^2$; $\therefore u = \frac{\pi}{2a^2}(1 - e^{-ar})$.

$$\therefore \left. \begin{aligned} I_1 &= \int_0^{\infty} \frac{\sin rx}{x(a^2+x^2)} dx = \frac{\pi}{2a^2}(1 - e^{-ar}) \\ I_2 &= \int_0^{\infty} \frac{\cos rx}{a^2+x^2} dx = \frac{\pi}{2a} e^{-ar} \\ I_3 &= \int_0^{\infty} \frac{x \sin rx}{a^2+x^2} dx = \frac{\pi}{2} e^{-ar} \end{aligned} \right\} \begin{matrix} (\alpha + ve) \\ (r + ve) \end{matrix}$$

The collected results are for the various signs of a and r :

	$a +$ $r +$	$a +$ $r -$	$a -$ $r +$	$a -$ $r -$
I_1	$\frac{\pi}{2a^2}(1 - e^{-ar})$	$-\frac{\pi}{2a^2}(1 - e^{ar})$	$\frac{\pi}{2a^2}(1 - e^{ar})$	$-\frac{\pi}{2a^2}(1 - e^{-ar})$
I_2	$\frac{\pi}{2a} e^{-ar}$	$\frac{\pi}{2a} e^{ar}$	$-\frac{\pi}{2a} e^{ar}$	$-\frac{\pi}{2a} e^{-ar}$
I_3	$\frac{\pi}{2} e^{-ar}$	$-\frac{\pi}{2} e^{ar}$	$\frac{\pi}{2} e^{ar}$	$-\frac{\pi}{2} e^{-ar}$

1057. **A Reduction Formula.**

Let $I_n = \int_0^\infty \frac{\cos rx}{(a^2 + x^2)^n} dx$. Then $I_1 = \frac{\pi}{2} a^{-1} e^{-ra}$,

and $\frac{dI_n}{da} = -2na \int_0^\infty \frac{\cos rx}{(a^2 + x^2)^{n+1}} dx = -2naI_{n+1}$.

Therefore the successive integrals for the cases $n=2, n=3$, etc., may be calculated by the rule $I_{n+1} = -\frac{1}{2na} \frac{dI_n}{da}$.

In each case $\frac{\pi}{2} e^{-ra}$ will appear as a factor. Let $I_n = \frac{\pi}{2} A_n e^{-ra}$

Then $\frac{dI_n}{da} = \frac{\pi}{2} \left(\frac{dA_n}{da} - rA_n \right) e^{-ra}$ and $I_{n+1} = \frac{\pi}{2} A_{n+1} e^{-ra}$.

Hence the form of A_n may be calculated by successive applications of the formula

$$A_{n+1} = \frac{1}{2n} \left[r \frac{A_n}{a} - \frac{1}{a} \frac{dA_n}{da} \right], \quad \text{where } A_1 = a^{-1}.$$

$$\text{Thus } A_2 = \frac{1}{2} \frac{1}{1!} [r^2 a^{-2} + a^{-3}],$$

$$A_3 = \frac{1}{2^2} \frac{1}{2!} [r^2 a^{-3} + 3ra^{-4} + 3a^{-5}],$$

$$A_4 = \frac{1}{2^3} \frac{1}{3!} [r^3 a^{-4} + 6r^2 a^{-5} + 15ra^{-6} + 15a^{-7}], \quad \text{and so on.}$$

So that if

$$A_n = \frac{1}{2^{n-1}} \frac{1}{(n-1)!} [K_1 r^{n-1} a^{-n} + K_2 r^{n-2} a^{-(n+1)} + K_3 r^{n-3} a^{-(n+2)} + \dots \text{ to } n \text{ terms}],$$

$$A_{n+1} = \frac{1}{2^n} \frac{1}{n!} [K_1 r^n a^{-(n+1)} + K_2 r^{n-1} a^{-(n+2)} + K_3 r^{n-2} a^{-(n+3)} + \dots \\ + nK_1 r^{n-1} a^{-(n+2)} + (n+1)K_2 r^{n-2} a^{-(n+3)} + \dots],$$

and the coefficients in A_{n+1} are

$$K_1 (=1), \quad K_2 + nK_1, \quad K_3 + (n+1)K_2, \quad K_4 + (n+2)K_3, \quad \text{etc. } \dots, \quad (2n-1)K_n,$$

and the law of formation of the successive sets of coefficients is easy.

It may be shown by induction that the general formula is

$$A_n = \frac{1}{2^{n-1}(n-1)!} \left[r^{n-1} a^{-n} + \frac{n(n-1)}{2} r^{n-2} a^{-(n+1)} \right. \\ + \frac{(n+1)n(n-1)(n-2)}{2 \cdot 4} r^{n-3} a^{-(n+2)} \\ \left. + \frac{(n+2)(n+1)n(n-1)(n-2)(n-3)}{2 \cdot 4 \cdot 6} r^{n-4} a^{-(n+3)} + \dots \right].$$

$$\text{Thus } \int_0^{\infty} \frac{\cos rx}{(a^2+x^2)^n} dx = \frac{\pi}{2^n} \frac{e^{-ar}}{(n-1)!} \left[r^{n-1} a^{-n} + \frac{n(n-1)}{2} r^{n-2} a^{-(n+1)} \right. \\ \left. + \frac{(n+1)n(n-1)(n-2)}{2 \cdot 4} r^{n-3} a^{-(n+2)} + \dots \text{ to } n \text{ terms} \right].$$

$$\text{In the same way } \int_0^{\infty} \frac{x \sin rx}{(a^2+x^2)^n} dx = \frac{\pi}{4} \frac{e^{-ra}}{(n-1)!} r A_{n-1},$$

or we may deduce the result from the former by differentiation with regard to r .

$$1058. \text{ Consider the Integral } I = \int_0^{\pi} \frac{\sin rx dx}{x(x^4+2a^2x^2\cos 2a+\alpha^4)}.$$

We have

$$\frac{dI}{dr} = \int_0^{\pi} \frac{\cos rx dx}{x^4+2a^2x^2\cos 2a+\alpha^4}; \quad \frac{d^2I}{dr^2} = \int_0^{\pi} \frac{-x \sin rx dx}{x^4+2a^2x^2\cos 2a+\alpha^4}; \\ \frac{d^3I}{dr^3} = \int_0^{\pi} \frac{-x^2 \cos rx dx}{x^4+2a^2x^2\cos 2a+\alpha^4}; \quad \frac{d^4I}{dr^4} = \int_0^{\pi} \frac{x^3 \sin rx dx}{x^4+2a^2x^2\cos 2a+\alpha^4}.$$

Hence, when the first of these integrals has been found, the other four of this particular class follow by differentiation. Adding the fifth to $(-2a^2\cos 2a)$ times the third and a^4 times the first, we have

$$\frac{d^4I}{dr^4} - 2a^2\cos 2a \frac{d^2I}{dr^2} + a^4I = \int_0^{\pi} \frac{\sin rx}{x} dx = \frac{\pi}{2}, \quad 0 \quad \text{or} \quad -\frac{\pi}{2},$$

according as r is positive, zero or negative. We shall assume r positive, for the case r negative will be at once deducible from our result by changing the sign of r . We also take a positive and a an acute angle.

The differential equation is of the ordinary class with linear coefficients (*I.C. for Beginners*, pages 244 to 263). It may be written

$$[\{ D^2 - a^2\cos 2a \}^2 + a^4\sin^2 2a] I = \frac{\pi}{2},$$

and the general solution is

$$I = \frac{\pi}{2a^4} + e^{-ar\cos a} \{ A_1 \cos(ar \sin a) + A_2 \sin(ar \sin a) \} \\ + e^{ar\cos a} \{ A_3 \cos(ar \sin a) + A_4 \sin(ar \sin a) \}.$$

Since an infinite value of r does not make I infinite, the last two terms must vanish, i.e. $A_3 = A_4 = 0$. And when r is diminished indefinitely to zero, I should vanish. Therefore we have $A_1 = -\frac{\pi}{2a^4}$.

To determine the remaining constant A_2 , we may differentiate with regard to r ; we obtain

$$\frac{dI}{dr} = -a \cos a e^{-ar\cos a} \{ A_1 \cos(ar \sin a) + A_2 \sin(ar \sin a) \} \\ - a \sin a e^{-ar\cos a} \{ A_1 \sin(ar \sin a) - A_2 \cos(ar \sin a) \},$$

and when r is diminished indefinitely to zero this becomes in the limit

$$\frac{dI}{dr} = -a \cos a \cdot A_1 + a \sin a \cdot A_2.$$

But when r is diminished indefinitely to zero, we ultimately have

$$\frac{dI}{dr} = \int_0^{\infty} \frac{dx}{x^4 + 2a^2x^2 \cos 2a + a^4} = \frac{\pi}{4a^3 \cos a} \quad (\text{see p. 159, Vol. I.});$$

$$\therefore a \sin a \cdot A_2 - a \cos a \cdot A_1 = \frac{\pi}{4a^3 \cos a},$$

$$\text{i.e.} \quad a \sin a \cdot A_2 = -\frac{\pi}{2a^3} \cos a + \frac{\pi}{4a^3 \cos a} = -\frac{\pi \cos 2a}{4a^3 \cos a},$$

$$\text{and} \quad A_2 = -\frac{\pi}{2a^4} \cot 2a.$$

$$\text{Hence} \quad I = \frac{\pi}{2a^4} [1 - e^{-ar \cos a} \{ \cos(ar \sin a) + \cot 2a \sin(ar \sin a) \}]$$

$$= \frac{\pi}{2a^4} \left\{ 1 - e^{-ar \cos a} \frac{\sin(ar \sin a + 2a)}{\sin 2a} \right\},$$

i.e. we have for values of $r > 0$

$$\int_0^{\infty} \frac{\sin rx \, dx}{x(x^4 + 2a^2x^2 \cos 2a + a^4)} = \frac{\pi}{2a^4} \left\{ 1 - e^{-ar \cos a} \frac{\sin(ar \sin a + 2a)}{\sin 2a} \right\},$$

$$\int_0^{\infty} \frac{\cos rx \, dx}{x^4 + 2a^2x^2 \cos 2a + a^4} = \frac{\pi}{2a^3} e^{-ar \cos a} \frac{\sin(a + ar \sin a)}{\sin 2a},$$

$$\int_0^{\infty} \frac{x \sin rx \, dx}{x^4 + 2a^2x^2 \cos 2a + a^4} = \frac{\pi}{2a^2} e^{-ar \cos a} \frac{\sin(ar \sin a)}{\sin 2a},$$

$$\int_0^{\infty} \frac{x^2 \cos rx \, dx}{x^4 + 2a^2x^2 \cos 2a + a^4} = \frac{\pi}{2a} e^{-ar \cos a} \frac{\sin(a - ar \sin a)}{\sin 2a},$$

$$\int_0^{\infty} \frac{x^3 \sin rx \, dx}{x^4 + 2a^2x^2 \cos 2a + a^4} = \frac{\pi}{2} e^{-ar \cos a} \frac{\sin(2a - ar \sin a)}{\sin 2a}.$$

1059. Taking for instance the case when $\alpha = \frac{\pi}{4}$, $a = r\sqrt{2}$, so that $a \sin \alpha = c$,

$$\int_0^{\infty} \frac{\sin rx \, dx}{x(x^4 + 4c^4)} = \frac{\pi}{8c^4} \left\{ 1 - e^{-rc} \sin \left(rc + \frac{\pi}{2} \right) \right\} = \frac{\pi}{8c^4} (1 - e^{-rc} \cos rc),$$

$$\int_0^{\infty} \frac{\cos rx \, dx}{x^4 + 4c^4} = -\frac{\pi}{4c^3 \sqrt{2}} e^{-rc} \sin \left(rc + \frac{5\pi}{4} \right) = \frac{\pi}{8c^3} e^{-rc} (\sin rc + \cos rc),$$

$$\int_0^{\infty} \frac{x \sin rx \, dx}{x^4 + 4c^4} = \frac{\pi}{4c^2} e^{-rc} \sin \left(rc + \frac{8\pi}{4} \right) = \frac{\pi}{4c^2} e^{-rc} \sin rc.$$

$$\int_0^{\infty} \frac{x^2 \cos rx \, dx}{x^4 + 4c^4} = \frac{\pi}{2c\sqrt{2}} e^{-rc} \sin \left(rc + \frac{11\pi}{4} \right) = \frac{\pi}{4c} e^{-rc} (\cos rc - \sin rc),$$

$$\int_0^{\infty} \frac{x^3 \sin rx \, dx}{x^4 + 4c^4} = -\frac{\pi}{2} e^{-rc} \sin \left(rc + \frac{14\pi}{4} \right) = \frac{\pi}{2} e^{-rc} \cos rc.$$

1060. Consider $I = \int_0^{\infty} \frac{\sin rx}{x(x^6 + a^6)} dx$, r positive, }
 a positive. }

$$\text{We have} \quad \frac{dI}{dr} = \int_0^{\infty} \frac{\cos rx}{x^6 + a^6} dx; \quad \frac{d^2 I}{dr^2} = -\int_0^{\infty} \frac{x \sin rx}{x^6 + a^6} dx;$$

$$\frac{d^3 I}{dr^3} = -\int_0^{\infty} \frac{x^2 \cos rx}{x^6 + a^6} dx; \quad \frac{d^4 I}{dr^4} = \int_0^{\infty} \frac{x^3 \sin rx}{x^6 + a^6} dx;$$

$$\frac{d^5 I}{dr^5} = \int_0^\infty \frac{x^4 \cos rx}{x^6 + a^6} dx; \quad \frac{d^6 I}{dr^6} = - \int_0^\infty \frac{x^5 \sin rx}{x^6 + a^6} dx;$$

$$\therefore \frac{d^6 I}{dr^6} - a^6 I = - \int_0^\infty \left(x^5 + \frac{a^6}{x} \right) \frac{\sin rx}{x^6 + a^6} dx = - \int_0^\infty \frac{\sin rx}{x} dx = - \frac{\pi}{2}.$$

Solving this equation,

$$I = \frac{\pi}{2a^6} + A_1 e^{-ar} + A_2 e^{-\frac{ar}{2}} \cos\left(\frac{ar\sqrt{3}}{2} + A_3\right) + B_1 e^{ar} + B_2 e^{\frac{ar}{2}} \cos\left(\frac{ar\sqrt{3}}{2} + B_3\right).$$

Now, since the integral obviously remains finite when r becomes infinite, the terms with positive indices in their exponential factors must disappear.

Hence $B_1 = 0$ and $B_2 = 0$, and the form of the integral reduces to

$$I = \frac{\pi}{2a^6} + A_1 e^{-ar} + A_2 e^{-\frac{ar}{2}} \cos\left(\frac{ar\sqrt{3}}{2} + A_3\right).$$

Now I , $\frac{d^2 I}{dr^2}$, $\frac{d^4 I}{dr^4}$ ultimately vanish with r .

These considerations will determine A_1 , A_2 , A_3 .

$$\text{Now } \frac{d^n I}{dr^n} = A_1 (-a)^n e^{-ar} + A_2 a^n e^{-\frac{ar}{2}} \cos\left(\frac{ar\sqrt{3}}{2} + A_3 + n \cdot \frac{2\pi}{3}\right);$$

we therefore have

$$\left. \begin{aligned} 0 &= \frac{\pi}{2a^6} + A_1 + A_2 \cos A_3, \\ 0 &= + A_1 a^2 + A_2 a^2 \cos\left(A_3 + \frac{4\pi}{3}\right), \\ 0 &= + A_1 a^4 + A_2 a^4 \cos\left(A_3 + \frac{8\pi}{3}\right), \end{aligned} \right\} \begin{aligned} &\text{whence } A_3 = 0, \\ &A_2 = 2A_1 = -\frac{\pi}{3a^6}. \end{aligned}$$

Hence, for values of $r > 0$,

$$\int_0^\infty \frac{\sin rx}{x(x^6 + a^6)} dx = \frac{\pi}{6a^6} \left[3 - e^{-ar} - 2e^{-\frac{ar}{2}} \cos \frac{ar\sqrt{3}}{2} \right],$$

$$\int_0^\infty \frac{\cos rx}{x^6 + a^6} dx = \frac{\pi}{6a^6} \left[e^{-ar} - 2e^{-\frac{ar}{2}} \cos\left(\frac{ar\sqrt{3}}{2} + \frac{2\pi}{3}\right) \right],$$

$$\int_0^\infty \frac{x \sin rx}{x^6 + a^6} dx = \frac{\pi}{6a^6} \left[e^{-ar} + 2e^{-\frac{ar}{2}} \cos\left(\frac{ar\sqrt{3}}{2} + \frac{4\pi}{3}\right) \right],$$

$$\int_0^\infty \frac{x^2 \cos rx}{x^6 + a^6} dx = \frac{\pi}{6a^6} \left[-e^{-ar} + 2e^{-\frac{ar}{2}} \cos\left(\frac{ar\sqrt{3}}{2} + \frac{6\pi}{3}\right) \right],$$

$$\int_0^\infty \frac{x^3 \sin rx}{x^6 + a^6} dx = \frac{\pi}{6a^6} \left[-e^{-ar} - 2e^{-\frac{ar}{2}} \cos\left(\frac{ar\sqrt{3}}{2} + \frac{8\pi}{3}\right) \right],$$

$$\int_0^\infty \frac{x^4 \cos rx}{x^6 + a^6} dx = \frac{\pi}{6a^6} \left[e^{-ar} - 2e^{-\frac{ar}{2}} \cos\left(\frac{ar\sqrt{3}}{2} + \frac{10\pi}{3}\right) \right],$$

$$\int_0^\infty \frac{x^5 \sin rx}{x^6 + a^6} dx = \frac{\pi}{6a^6} \left[e^{-ar} + 2e^{-\frac{ar}{2}} \cos\left(\frac{ar\sqrt{3}}{2} + \frac{12\pi}{3}\right) \right],$$

some of which admit of a little simplification, but are left in their present form as exhibiting the general law followed by the several members of the group.

1061. The same process may evidently be extended to any integral of the class

$$\int_0^\infty \frac{\sin rx dx}{x(r^{2n} + 2a^{2n}x^{2n} \cos na + a^{4n})},$$

and its family of $2n$ other integrals may be obtained by differentiating $2n$ times with regard to r . But we exhibit another method of procedure in Art. 1067, which avoids the labour of determination of the various constants.

1062. We have seen that

$$\int_0^\infty \frac{\cos rx dx}{x^2 + a^2} = \frac{\pi}{2a} e^{-ar} \quad \text{or} \quad \frac{\pi}{2a} e^{ar},$$

according as r is positive or negative, a being supposed positive.

If a be negative, since the integrand is unaltered, the result will be $-\frac{\pi}{2a} e^{ar}$ or $-\frac{\pi}{2a} e^{-ar}$, according as r is positive or negative (see Art. 1056). The result must be positive in either case, and the index of the exponential must be negative, for the integral does not become infinite when r becomes infinite.

The four results are therefore

$$\begin{aligned} & \frac{\pi}{2a} e^{-ar}, \left(\begin{matrix} a + ve \\ r + ve \end{matrix} \right); & \frac{\pi}{2a} e^{ar}, \left(\begin{matrix} a + ve \\ r - ve \end{matrix} \right); \\ & -\frac{\pi}{2a} e^{ar}, \left(\begin{matrix} a - ve \\ r + ve \end{matrix} \right); & -\frac{\pi}{2a} e^{-ar}, \left(\begin{matrix} a - ve \\ r - ve \end{matrix} \right). \end{aligned}$$

Taking the case a and r both positive, it is clear that the integrand is not affected by a change of sign of x .

Hence

$$\int_{-\infty}^0 \frac{\cos rx}{x^2 + a^2} dx = \int_0^\infty \frac{\cos rx}{x^2 + a^2} dx, \quad \text{and} \quad \int_{-\infty}^\infty \frac{\cos rx}{x^2 + a^2} dx = \frac{\pi}{a} e^{-ar}, \dots (1)$$

with the modifications above specified, if a or r or both of them be negative.

Again,

$$\int_{-\infty}^\infty \frac{\sin rx}{x^2 + a^2} dx = 0, \dots \dots \dots (2)$$

for elements of the summation represented by the integral, for which the values of x are equal but of opposite sign, cancel each other.

1063. These facts enable us to calculate

$$I = \int_{-\infty}^{\infty} \frac{\cos rx}{(x-b)^2 + a^2} dx.$$

For, putting $x=b+z$, $I = \int_{-\infty}^{\infty} \frac{\cos rb \cos rz - \sin rb \sin rz}{z^2 + a^2} dz$
 $= \cos rb \int_{-\infty}^{\infty} \frac{\cos rz}{z^2 + a^2} dz - \sin rb \int_{-\infty}^{\infty} \frac{\sin rz}{z^2 + a^2} dz,$

i.e. $\int_{-\infty}^{\infty} \frac{\cos rx}{(x-b)^2 + a^2} dx = \frac{\pi}{a} e^{-ar} \cos br \quad (r > 0, a > 0). \dots\dots(3)$

It will be observed that this is independent of the sign of b , but subject to the same modifications as before with regard to the signs of a and r .

Differentiating (3) with regard to r ,

$$\int_{-\infty}^{\infty} \frac{x \sin rx}{(x-b)^2 + a^2} dx = \frac{\pi}{a} e^{-ar} (a \cos br + b \sin br); \dots\dots(4)$$

and integrating (3) with regard to r from $r=0$ to $r=r$,

$$\int_{-\infty}^{\infty} \frac{\sin rx dx}{x\{(x-b)^2 + a^2\}} = \frac{\pi}{a(a^2 + b^2)} \{a - e^{-ar}(a \cos br - b \sin br)\}, \dots(5)$$

where each formula is subject to the same modifications as before with regard to the signs of a and r if they be not both +ve.

Putting $b = p \cos \alpha$, $a = p \sin \alpha$, $\alpha < \pi$, p positive, we have the integrals

$$\int_{-\infty}^{\infty} \frac{\sin rx dx}{x(x^2 - 2px \cos \alpha + p^2)} = \frac{\pi}{p^2} + \frac{\pi}{p^2 \sin \alpha} e^{-pr \sin \alpha} \sin(pr \cos \alpha - \alpha),$$

$$\int_{-\infty}^{\infty} \frac{\cos rx dx}{x^2 - 2px \cos \alpha + p^2} = \frac{\pi}{p \sin \alpha} e^{-pr \sin \alpha} \cos(pr \cos \alpha),$$

$$\int_{-\infty}^{\infty} \frac{x \sin rx dx}{x^2 - 2px \cos \alpha + p^2} = \frac{\pi}{\sin \alpha} e^{-pr \sin \alpha} \sin(pr \cos \alpha + \alpha),$$

which again can be readily modified as before for the cases in which any of the constants involved have negative values.

1064. Again, differentiating $\int_{-\infty}^{\infty} \frac{\sin rx}{x^2 + a^2} dx = 0$ with regard to r , we have

$$\int_{-\infty}^{\infty} \frac{x \cos rx}{x^2 + a^2} dx = 0;$$

and from this we may obtain the value of the integral

$$I_1 \equiv \int_{-\infty}^{\infty} \frac{x \cos rx}{(x-b)^2 + a^2} dx.$$

$$\begin{aligned} \text{Putting } x=b+z, \quad I_1 &= \int_{-\infty}^{\infty} \frac{(b+z) \cos rz}{z^2+a^2} dz \\ &= \int_{-\infty}^{\infty} \frac{b \cos br \cos rz + z \cos br \cos rz - b \sin br \sin rz - z \sin br \sin rz}{z^2+a^2} dz \\ &= b \cos br \int_{-\infty}^{\infty} \frac{\cos rz}{z^2+a^2} dz - \sin br \int_{-\infty}^{\infty} \frac{z \sin rz}{z^2+a^2} dz, \end{aligned}$$

since the other two integrals vanish,

$$= b \cos br \frac{\pi}{a} e^{-ar} - \sin br \pi e^{-ar};$$

$$\therefore \int_{-\infty}^{\infty} \frac{x \cos rx}{(x-b)^2+a^2} dx = \frac{\pi}{a} e^{-ar} (b \cos br - a \sin br),$$

and

$$\int_{-\infty}^{\infty} \frac{x \cos rx}{x^2-2px \cos a + p^2} dx = \frac{\pi}{\sin a} e^{-pr \sin a} \cos(pr \cos a + a),$$

where $b = p \cos a$, $a = p \sin a$, and it is understood that a is positive, p positive, $\sin a$ positive; and the formula can be readily modified as before to meet other cases, and other integrals may be deduced by integration with regard to r .

1065. The integral $I = \int_{-\infty}^{\infty} \frac{\sin rx}{(x-b)^2+a^2} dx$ may also be obtained in the same way. Put $x=b+z$.

$$\begin{aligned} I &= \int_{-\infty}^{\infty} \frac{\sin br \cos rz + \cos br \sin rz}{z^2+a^2} dz \\ &= \sin br \int_{-\infty}^{\infty} \frac{\cos rz}{z^2+a^2} dz + \cos br \int_{-\infty}^{\infty} \frac{z \sin rz}{z^2+a^2} dz = \frac{\pi}{a} e^{-ar} \sin br, \end{aligned}$$

for the second integral vanishes.

$$\begin{aligned} \text{Since } \int_{-\infty}^{\infty} \frac{\cos rx}{(x-b)^2+a^2} dx &= \frac{\pi}{a} e^{-ar} \cos br; \\ \int_{-\infty}^{\infty} \frac{\sin rx}{(x-b)^2+a^2} dx &= \frac{\pi}{a} e^{-ar} \sin br; \\ \int_{-\infty}^{\infty} \frac{x \cos rx}{(x-b)^2+a^2} dx &= \frac{\pi}{a} e^{-ar} (b \cos br - a \sin br); \\ \int_{-\infty}^{\infty} \frac{x \sin rx}{(x-b)^2+a^2} dx &= \frac{\pi}{a} e^{-ar} (a \cos br + b \sin br), \end{aligned}$$

it follows that by differentiating $n-1$ times with respect to a^2 , we can obtain the following integrals:

$$\begin{aligned} \int_{-\infty}^{\infty} \frac{\cos rx}{\{(x-b)^2+a^2\}^n} dx &= P \cos br; & \int_{-\infty}^{\infty} \frac{\sin rx}{\{(x-b)^2+a^2\}^n} dx &= P \sin br; \\ \int_{-\infty}^{\infty} \frac{x \cos rx}{\{(x-b)^2+a^2\}^n} dx &= Pb \cos br - Q \sin br; \\ \int_{-\infty}^{\infty} \frac{x \sin rx}{\{(x-b)^2+a^2\}^n} dx &= Q \cos br + Pb \sin br, \end{aligned}$$

where

$$P \equiv \frac{(-1)^{n-1} \pi}{(n-1)!} \left(\frac{d}{2a da} \right)^{n-1} \left(\frac{e^{-ar}}{a} \right), \quad Q \equiv \frac{(-1)^{n-1} \pi}{(n-1)!} \left(\frac{d}{2a da} \right)^{n-1} (e^{-ar}).$$

1066. It follows that if $f(x)$ and $\phi(x)$ be rational integral algebraic functions of x , of which the degree of $f(x)$ in x is lower than that of $\phi(x)$, and if the roots of $\phi(x)=0$ be all unreal, then since $\frac{f(x)}{\phi(x)}$ may be expressed as the sum of a set of partial fractions of the types

$$\frac{Ax+B}{(x-b)^2+a^2}, \quad \frac{A'x+B'}{\{(x-b')^2+a'^2\}^n},$$

the latter only occurring in the case of $\phi(x)$ having repeated imaginary roots, we can obtain the value of any definite integral of either of the forms

$$\int_{-\infty}^{\infty} \frac{f(x)}{\phi(x)} \sin rx \, dx \quad \text{or} \quad \int_{-\infty}^{\infty} \frac{f(x)}{\phi(x)} \cos rx \, dx.$$

$$\text{Ex. 1. } \int_{-\infty}^{\infty} \frac{\cos rx \, dx}{(x^2+a^2)(x^2+b^2)(x^2+c^2)} = \sum \frac{1}{(a^2-b^2)(a^2-c^2)} \int_{-\infty}^{\infty} \frac{\cos rx}{x^2+a^2} \, dx = \text{etc.}$$

$$\text{Ex. 2. } \int_{-\infty}^{\infty} \frac{\sin rx \, dx}{(x^2+a^2)(x^2+b^2)(x^2+c^2)} = 0.$$

1067. Integrals of the class $\int_0^{\infty} \frac{\cos rx}{x^{2n}+a^{2n}} \, dx$ may also be conveniently treated as follows, without the formation of a differential equation as used in Art. 1060.

Putting $\frac{1}{x^{2n}+a^{2n}}$ into partial fractions, we have

$$\frac{1}{x^{2n}+a^{2n}} = \frac{1}{na^{2n-1}} \sum_{\lambda=0}^{n-1} \frac{a-x \cos a_{\lambda}}{(x-a \cos a_{\lambda})^2+a^2 \sin^2 a_{\lambda}},$$

where $a_{\lambda} = \frac{2\lambda+1}{2n} \pi$, and a_{λ} is less than π for the whole range of values of λ from 0 to $n-1$, and $\sin a_{\lambda}$ is therefore positive.

$$\begin{aligned} \int_{-\infty}^{\infty} \frac{\cos rx}{x^{2n}+a^{2n}} \, dx &= \frac{1}{na^{2n-1}} \sum_0^{n-1} \int_{-\infty}^{\infty} \frac{(a-x \cos a_{\lambda}) \cos rx \, dx}{(x-a \cos a_{\lambda})^2+a^2 \sin^2 a_{\lambda}} \\ &= \frac{1}{na^{2n-1}} \sum_0^{n-1} \frac{\pi}{\sin a_{\lambda}} e^{-ar \sin a_{\lambda}} \{ \cos(ar \cos a_{\lambda}) - \cos a_{\lambda} \cos(ar \cos a_{\lambda} + a_{\lambda}) \} \\ &= \frac{\pi}{na^{2n-1}} \sum_0^{n-1} e^{-ar \sin a_{\lambda}} \sin(ar \cos a_{\lambda} + a_{\lambda}); \end{aligned}$$

and since the integrand $\frac{\cos rx}{x^{2n}+a^{2n}}$ is not affected by a change of sign of x , we have

$$\int_0^{\infty} \frac{\cos rx}{x^{2n}+a^{2n}} dx = \frac{1}{2} \int_{-\infty}^{\infty} \frac{\cos rx}{x^{2n}+a^{2n}} dx.$$

$$\text{Therefore } I \equiv \int_0^{\infty} \frac{\cos rx}{x^{2n}+a^{2n}} dx$$

$$= \frac{\pi}{2n\alpha^{2n-1}} \sum_0^{n-1} e^{-ar \sin \frac{2\lambda+1}{2n} \pi} \sin \left(ar \cos \frac{2\lambda+1}{2n} \pi + \frac{2\lambda+1}{2n} \pi \right).$$

The other members of the family of integrals obtainable from this are

$$\int_0^{\infty} \frac{\sin rx}{x(x^{2n}+a^{2n})} dx \text{ by integration with regard to } r, \text{ from } r=0 \text{ to } r=r, \text{ and}$$

$$\int_0^{\infty} \frac{x \sin rx}{x^{2n}+a^{2n}} dx, \quad \int_0^{\infty} \frac{x^2 \cos rx}{x^{2n}+a^{2n}} dx, \quad \int_0^{\infty} \frac{x^3 \sin rx}{x^{2n}+a^{2n}} dx, \dots \int_0^{\infty} \frac{x^{2n-1} \sin rx}{x^{2n}+a^{2n}} dx,$$

the latter system by differentiation with regard to r .

Since

$$\frac{d}{dr} e^{-ar \sin a} \sin(ar \cos a + a) = a e^{-ar \sin a} \sin \left(ar \cos a + 2a + \frac{\pi}{2} \right),$$

we have

$$\int_0^{\infty} \frac{x^k \cos \left(rx + \frac{k\pi}{2} \right)}{x^{2n}+a^{2n}} dx = \frac{d^k I}{dr^k}$$

$$= \frac{\pi}{2n\alpha^{2n-1}} \alpha^k \sum_0^{n-1} e^{-ar \sin \frac{2\lambda+1}{2n} \pi} \sin \left[ar \cos \frac{2\lambda+1}{2n} \pi + (k+1) \frac{2\lambda+1}{2n} \pi + \frac{k\pi}{2} \right],$$

where $k \geq 2n-1$, which gives all the integrals from

$$\int_0^{\infty} \frac{x \sin rx}{x^{2n}+a^{2n}} dx \dots \text{ to } \int_0^{\infty} \frac{x^{2n-1} \sin rx}{x^{2n}+a^{2n}} dx$$

The integral $\int_0^{\infty} \frac{\sin rx}{x(x^{2n}+a^{2n})} dx$ is of the form

$$A + \frac{\pi}{2n\alpha^{2n-1}} \alpha^{-1} \sum_0^{n-1} e^{-ar \sin \frac{2\lambda+1}{2n} \pi} \sin \left(ar \cos \frac{2\lambda+1}{2n} \pi - \frac{\pi}{2} \right),$$

where A is a quantity, independent of r , to be found.

And since the integral vanishes with r ,

$$0 = A + \frac{\pi}{2n\alpha^{2n}} \sum_0^{n-1} \sin \left(-\frac{\pi}{2} \right) = A - \frac{\pi}{2\alpha^{2n}}; \quad \therefore A = \frac{\pi}{2\alpha^{2n}};$$

$$\therefore \int_0^{\infty} \frac{\sin rx}{x(x^{2n}+a^{2n})} dx = \frac{\pi}{2\alpha^{2n}} - \frac{\pi}{2n\alpha^{2n}} \sum_0^{n-1} e^{-ar \sin \frac{2\lambda+1}{2n} \pi} \cos \left(ar \cos \frac{2\lambda+1}{2n} \pi \right).$$

1068. Those interested in the history of the subject may refer to an article by Poisson in the *Jour. de l'École Polyt.*, xvi. p. 225, where the integral of $\int_0^\infty \frac{\cos rx}{1+x^{2n}} dx$ is discussed, and to articles by Catalan in the *Journal de Mathématiques*, vol. v. p. 110,* for integrals of form $\int_0^\infty \frac{\cos rx dx}{(1+x^2)^n}$.

1069. In the same way we may evaluate the integral

$$\int_0^\infty \frac{\cos rx dx}{x^{4n} - 2a^{2n}x^{2n} \cos 2na + a^{4n}} \quad (a > 0) \\ (a < \pi)$$

with its attendant family of integrals derivable by differentiation and integration with regard to r .

For

$$\frac{1}{x^{4n} - 2a^{2n}x^{2n} \cos 2na + a^{4n}} = \frac{1}{2n \sin 2na} \frac{1}{a^{4n-1}} \sum \frac{\alpha \sin 2n\chi - x \sin(2n-1)\chi}{(x-a \cos \chi)^2 + a^2 \sin^2 \chi},$$

where $\chi = a + \frac{\lambda\pi}{n}$, the summation being for $2n$ consecutive integral values of λ .

And it is to be noted that χ is greater than 0 and less than π (and therefore $\sin \chi$ positive) for values of λ such that $\lambda \frac{\pi}{n} > -a$ and $< \pi - a$ respectively,

i.e. $\lambda > -\frac{na}{\pi}$ and $\lambda < n - \frac{na}{\pi}$,

i.e. for $\lambda = -k, -k+1, \dots, n-k-1$, where k is the greatest integer in $\frac{na}{\pi}$; and that $\sin \chi$ is negative for values of λ from $\lambda = n-k$ up to $\lambda = 2n-k-1$.

Now

$$\int_{-\infty}^\infty \frac{\cos rx dx}{(x-a \cos \chi)^2 + a^2 \sin^2 \chi} = \frac{\pi}{a \sin \chi} e^{-ar \sin \chi} \cos(ar \cos \chi) \quad \text{if } \sin \chi \text{ be } +"$$

and $= -\frac{\pi}{a \sin \chi} e^{ar \sin \chi} \cos(ar \cos \chi) \quad \text{if } \sin \chi \text{ be } -"$,

and

$$\int_{-\infty}^\infty \frac{x \cos rx dx}{(x-a \cos \chi)^2 + a^2 \sin^2 \chi} = \frac{\pi}{\sin \chi} e^{-ar \sin \chi} \cos(ar \cos \chi + \chi) \quad \text{if } \sin \chi \text{ be } +"$$

and $= -\frac{\pi}{\sin \chi} e^{ar \sin \chi} \cos(ar \cos \chi - \chi) \quad \text{if } \sin \chi \text{ be } -"$.

*Gregory, *Examples*, p. 486.

$$\begin{aligned}
& \text{Hence } 2n \sin 2na \frac{a^{4n-1}}{\pi} \int_{-\infty}^{\infty} \frac{\cos rx \, dx}{x^{4n} - 2a^{2n}x^{2n} \cos 2na + a^{4n}} \\
&= \sum_{-k}^{n-k-1} \frac{e^{-ar \sin \chi}}{\sin \chi} [\sin 2n\chi \cos(ar \cos \chi) - \sin(2n-1)\chi \cos(ar \cos \chi + \chi)] \\
&\quad - \sum_{n-k}^{2n-k-1} \frac{e^{ar \sin \chi}}{\sin \chi} [\sin 2n\chi \cos(ar \cos \chi) - \sin(2n-1)\chi \cos(ar \cos \chi - \chi)] \\
&= \sum_{-k}^{n-k-1} e^{-ar \sin \chi} \cos(ar \cos \chi - (2n-1)\chi) - \sum_{n-k}^{2n-k-1} e^{ar \sin \chi} \cos(ar \cos \chi + (2n-1)\chi)
\end{aligned}$$

where k is the greatest integer in $\frac{na}{\pi}$ and $\chi = a + \frac{\lambda\pi}{n}$.

Also, since the integrand is not affected by a change in the sign of x ,

$$\int_0^{\infty} \frac{\cos rx \, dx}{x^{4n} - 2a^{2n}x^{2n} \cos 2na + a^{4n}} = \frac{1}{2} \int_{-\infty}^{\infty} \frac{\cos rx \, dx}{x^{4n} - 2a^{2n}x^{2n} \cos 2na + a^{4n}}.$$

The attendant family of integrals formed by differentiating $4n-1$ times with regard to r can now be written down, and are of type

$$\begin{aligned}
& 4n \sin 2na \cdot \frac{a^{4n-p-1}}{\pi} \int_0^{\infty} \frac{x^p \cos\left(r, r + p \frac{\pi}{2}\right) dx}{x^{4n} - 2a^{2n}x^{2n} \cos 2na + a^{4n}} \\
&= \sum_{-k}^{n-k-1} e^{-ars \sin \chi} \cos \left\{ ar \cos \chi - (2n-1)\chi + p\left(\frac{\pi}{2} + \chi\right) \right\} \\
&\quad - \sum_{n-k}^{2n-k-1} e^{ars \sin \chi} \cos \left\{ ar \cos \chi + (2n-1)\chi + p\left(\frac{\pi}{2} - \chi\right) \right\},
\end{aligned}$$

and the integration with regard to r from 0 to r furnishes the remaining member of the family, viz.

$$\begin{aligned}
& 4n \sin 2na \cdot \frac{a^{4n}}{\pi} \int_0^{\infty} \frac{\sin rx \, dx}{x(x^{4n} - 2a^{2n}x^{2n} \cos 2na + a^{4n})} - 2n \sin 2na \\
&= \sum_{-k}^{n-k-1} e^{-ar \sin \chi} \cos \left\{ ar \cos \chi - (2n-1)\chi - \left(\frac{\pi}{2} + \chi\right) \right\} \\
&\quad - \sum_{n-k}^{2n-k-1} e^{ar \sin \chi} \cos \left\{ ar \cos \chi + (2n-1)\chi - \left(\frac{\pi}{2} - \chi\right) \right\} \\
&= \sum_{-k}^{n-k-1} e^{-ar \sin \chi} \sin(ar \cos \chi - 2na) - \sum_{n-k}^{2n-k-1} e^{ar \sin \chi} \sin(ar \cos \chi + 2na),
\end{aligned}$$

k and χ being as defined before.

1070. It will be noted further that the integral

$$\int_0^{\infty} \frac{\cos rx \, dx}{x^{4n} + 2a^{2n}x^{2n} \cos 2n\beta + a^{4n}}$$

and its accompanying family of integrals can be deduced from the above family by writing $a = \frac{\pi}{2n} - \beta$.

PROBLEMS.

1. Prove that

$$\left[\int_0^x e^{-ax} \cos bx \, dx \right]^2 + \left[\int_0^x e^{-ax} \sin bx \, dx \right]^2 = e^{-2ax} / (a^2 + b^2). \quad [\gamma, 1893.]$$

2. If $u_n = \int_0^{\infty} x^n e^{-ax^2} dx$, show that $u_n = \frac{n-1}{2a} u_{n-2}$.

Hence calculate u_n where n is any positive integer. [TRINITY, 1881.]

3. Show that $\int_0^{\infty} \frac{e^{-x} \sin^4 x}{x} dx = \frac{1}{16} \log \frac{625}{17}$. [β, 1891.]

4. Evaluate $\int_{-\infty}^{\infty} e^{-(ax^2+bx+c)} dx$. [COLLEGES, 1879.]

5. Deduce from the integral $\int_0^{\infty} \frac{\cos rx}{1+x^2} dx$ the result

$$\int_0^{\infty} \frac{\sin rx}{x(n^2+x^2)} dx = \frac{\pi}{2n^2} (1 - e^{-nr}); \quad (n + \infty).$$

6. Find the value of $\int_0^{\infty} \left(\frac{1}{e^{mx} + e^{-mx}} \right)^n dx$, where n is a positive integer. [MATH. TRIP., Pt. I., 1890.]

7. Show that $\int_0^x \frac{\sin qx \sinh qx}{(\cosh qx + \cos qx)^2} dx = \frac{1}{2q}$. [β, 1891.]

8. Show that $\int_0^{\infty} \frac{\sinh px \sin qx}{(\cosh px + \cos qx)^2} dx = \frac{q}{p^2 + q^2}$.

9. Show that, if p be a positive quantity,

$$\int_0^{\infty} \frac{\sinh px}{x} \left(\frac{1}{\cosh px + \cos ax} - \frac{1}{\cosh px + \cos bx} \right) dx = \frac{1}{2} \log \frac{p^2 + a^2}{p^2 + b^2}. \quad [\text{MATH. TRIPPOS, 1890.}]$$

10. Prove that

$$(a) \int_{\frac{\pi}{4}}^{\frac{\pi}{2}} \frac{x \, dx}{\sin x \cos x} = \frac{\pi}{4} \log 3; \quad (b) \int_{\frac{\pi}{4}-a}^{\frac{\pi}{4}+a} \frac{x \, dx}{\sin x \cos x} = \pi \tanh^{-1}(\tan a).$$

11. Prove that $\int_0^{\frac{\pi}{2}} (\cos^n \theta + \sin^n \theta)^{-2n} d\theta = \frac{(n-1)!}{n(n+1)(n+2)\dots(2n-1)}$, where n is a positive integer. [MATH. TRIPPOS, 1889.]

12. Prove that $\int_{-\infty}^{\infty} e^{-x^2} \cos 2nx \, dx = \sqrt{\pi} e^{-n^2}$. [ε, 1883.]

13. Prove that $\int_0^{\infty} \frac{\sin rx}{x} \frac{\cosh x\theta}{\cosh x \frac{\pi}{2}} dx = \cot^{-1} \left(\frac{\cos \theta}{\sinh r} \right)$. [α, 1885.]

14. Prove that $\int_0^x \frac{\cos bx}{x} \tanh \frac{\pi x}{2} dx = \log \left(\coth \frac{b}{2} \right)$. [COLLEGES, 1879.]
15. Prove that $\int_0^u \frac{du}{(e \cosh u - 1)^n} = \frac{1}{(e^2 - 1)^{n-1}} \int_0^\theta (e \cos \theta + 1)^{n-1} d\theta$,
if $(e \cos \theta + 1)(e \cosh u - 1) = e^2 - 1$. [MATH. TRIPOS, 1885.]

16. Prove that $\int_0^\infty \frac{\cos 4kx \tanh x}{x} dx = \log_e \coth k\pi$.
[MATH. TRIPOS, 1889.]

17. Prove that, if α lies between $-\pi/4$ and $\pi/4$,
$$\int_0^\pi \frac{d\theta}{1 - 2 \sin 2\alpha \cos \theta + \cos^2 \theta} = \frac{\pi \cos \alpha}{\sqrt{2} \cos^3 2\alpha}$$
.
[MATH. TRIPOS, 1885.]

18. Prove that $\int_0^1 \frac{dx}{(1 - x^{2n})^{\frac{3}{2}}} = \frac{\pi}{2n \sin \frac{\pi}{2n}}$.
[β , 1888.]

19. Prove that $4 \int_0^1 \frac{dx}{(1 - x^4)^{\frac{3}{2}}} = 2 \int_0^1 \frac{dx}{(1 - x^2)^{\frac{3}{2}}} = \frac{\{\Gamma(\frac{1}{4})\}^2}{(2\pi)^{\frac{3}{2}}}$.
[TRINITY, 1889.]

20. Evaluate

$$(a) e^{-x^2} \int_0^x x^2 e^{x^2} dx; \quad (b) e^{-x^2} \int_0^x x^3 e^{x^2} dx;$$

$$(c) e^{-x^2} \int_0^x x^4 e^{x^2} dx; \quad (d) x e^{-x^2} \int_0^x e^{x^2} dx,$$

where in each case x becomes infinite.

21. Prove that $\int_0^\infty e^{-x} \frac{\sin tx}{\sinh x} dx = \frac{\pi}{2} \coth t \frac{\pi}{2} - \frac{1}{t}$.
22. Show that $\int_0^\infty \frac{\cos x}{1 + x^2} dx = \int_0^\infty \frac{\cos x}{(1 + x^2)^2} dx = \frac{8}{7} \int_0^\infty \frac{\cos x}{(1 + x^2)^3} dx$.
[MATH. TRIPOS, 1876.]
23. Evaluate $\int_{-\infty}^\infty \frac{\cos mx}{1 + x + x^2} dx$. [MATH. TRIPOS, 1892.]

24. Prove that, if m be positive,

$$\int_0^\infty \frac{\cos mx}{1 + x^2 + x^4} dx = \frac{\pi}{\sqrt{3}} e^{-\frac{1}{2}m\sqrt{3}} \sin \left(\frac{1}{2}m + \frac{1}{8}\pi \right).$$

[MATH. TRIPOS, 1892.]

25. Show that (i) $\int_0^\infty \frac{\cos ax}{1 + x^4} dx = \frac{\pi}{2\sqrt{2}} e^{-\frac{a}{\sqrt{2}}} \left\{ \cos \frac{a}{\sqrt{2}} + \sin \frac{a}{\sqrt{2}} \right\}$.
[LAPLACE, *Mém. de l'Inst.*, 1810.]

$$(ii) \int_0^\infty \frac{\cos x dx}{x^4 + 4a^4} = \frac{\pi e^{-a}}{8a^3} (\cos a + \sin a).$$

[MATH. TRIPOS, Pt. I., 1914.]

26. Show that $\int_0^{\infty} \frac{x \sin 2ax}{x^4 + 1} dx = \frac{\pi}{2} e^{-a\sqrt{2}} \sin a\sqrt{2}$. [ST. JOHN'S, 1883.]

27. Show that $\int_0^{\infty} \frac{x \sin bx}{(1+x^2)(a^2+x^2)} dx = \frac{\pi}{2} \frac{e^{-b} - e^{-ab}}{a^2 - 1}$; $\left(\frac{a + \sqrt{a^2 - 1}}{b + \sqrt{b^2 - 1}}\right)$.

28. Prove that

$$\begin{aligned} \int_0^{\infty} \frac{x^{m-1} dx}{(1+2x \cos \alpha + x^2)^m (1+x^2)} &= \int_0^1 \frac{x^{m-1} dx}{(1+2x \cos \alpha + x^2)^m} \\ &= \frac{1}{2^m \sin^{2m-1} \alpha} \int_0^{\alpha} (\cos x - \cos \alpha)^{m-1} dx \\ &= \frac{1}{2^m (m-1)!} \left\{ \frac{1}{\sin \alpha} \frac{d}{d\alpha} \right\}^{m-1} \left(\frac{\alpha}{\sin \alpha} \right). \end{aligned}$$

[WOLSTENHOLME, *Educ. Times*.]

29. Prove that $\int_0^{\infty} \frac{\sin \pi x}{x(1-x^2)} dx = \pi$. [MATH. TRIP., Pt. II., 1919.]

30. Prove that

$$\int_a^{\infty} e^{-nx-x^2} dx = \frac{e^{-na-a^2}}{2a+n} \left\{ 1 - \frac{2}{(2a+n)^2} + \frac{12}{(2a+n)^4} \right\} \text{ approximately.}$$

[γ, 1891.]

31. Prove that $\int_0^{\infty} e^{-x^2 \cos \theta} \sin(x^2 \sin \theta) dx = \frac{\sqrt{\pi}}{2} \sin \frac{\theta}{2}$. [COLL., 1892.]

32. From the integral $\int_0^{\infty} e^{-x^2 - \frac{a^2}{x^2}} dx = \frac{1}{2} \sqrt{\pi} e^{-2a}$, show that

$$\int_0^{\infty} \int_0^{\pi} e^{-r - \frac{a^2 \operatorname{cosec}^2 \theta}{r}} dr d\theta = \pi e^{-2a}. \quad [\text{TRINITY, 1886.}]$$

33. Express the sum of the series $1 + x\sqrt{1} + x\sqrt{2} + x\sqrt{3} + \dots$ ad inf. by means of a definite integral, x being a real quantity less than unity. [TRINITY, 1895.]

34. Prove the formula

$$\int_{-\infty}^{\infty} e^{-a^2 x^2} \frac{\sin(2n+1)bx}{\sin bx} dx = \frac{\sqrt{\pi}}{a} \left[1 + 2 \sum_{r=1}^{r=n} e^{-\frac{r^2 b^2}{a^2}} \right].$$

[ST. JOHN'S, 1881.]

35. Prove that $\int_{-\infty}^{\infty} \int_{-\infty}^{\infty} \frac{dx dy}{xy(x+y)} = \log \left\{ \frac{(a+b)^{\frac{1}{a} + \frac{1}{b}}}{a^{\frac{1}{b}} b^{\frac{1}{a}}} \right\}$. [TRINITY, 1886.]

36. Show that $\int_0^{\infty} \tan^{-1} \frac{x}{a} \tan^{-1} \frac{x}{b} \frac{dx}{x^2} = \frac{\pi}{2} \log \frac{(a+b)^{\frac{1}{a} + \frac{1}{b}}}{a^{\frac{1}{b}} b^{\frac{1}{a}}}$.

[BERTRAND, *Calc. Int.*, p. 200.]

37. Show that $\int_0^\infty \phi\left(\frac{x}{a}\right) \phi\left(\frac{x}{b}\right) dx = \log \left[(a+b)^{a+b} a^{-a} b^{-b} \right]$,

where $\phi(x) = \int_x^\infty \frac{e^{-u} du}{u}$. [MATH. TRIP., 1882.]

38. Prove that $\int_{-\infty}^\infty e^{-t^2 + ut} \sqrt{2\lambda} dt = \sqrt{2\pi} e^{\lambda x^2}$,

and deduce $x^n e^{\lambda x^2} = \frac{(-1)^n}{\sqrt{2\pi} (2\lambda)^{\frac{n}{2}}} \int_{-\infty}^\infty e^{ux} \sqrt{2\lambda} \frac{d^n (e^{-t^2})}{dt^n} dt$. [ST. JOHN'S, 1882.]

39. Having given that

$$\int_0^\infty e^{-x^2 - \frac{a^2}{x^2}} dx = \frac{\sqrt{\pi}}{2} e^{-2a},$$

prove that $\int_0^\infty x^2 e^{-x^2 - \frac{1}{x^2}} dx = \frac{3\sqrt{\pi}}{4e^2}$. [COLLEGES, 1882.]

40. Having given that $\int_0^\infty e^{-ax^2} dx = \frac{1}{2} \sqrt{\frac{\pi}{a}}$, deduce the value of $\int_0^\infty e^{-ax^2} \cos bx dx$. [COLLEGES, 1879.]

41. Prove that $\int_0^\infty e^{-x^2} \cos ax \{(a^2 - 6)x - 4x^3\} dx = 1$.

42. Find the value of $\int_0^\infty e^{-t^2} \cos x dx$,

and prove that $\int_0^\infty e^{-t^2} \sin x dx = \frac{1}{\sqrt{e}} \int_0^1 e^{t^2} dt$. [ST. JOHN'S, 1886.]

43. Prove that $\int_0^\infty \frac{\sin 2nx}{\sin x} \frac{dx}{1+x^2} = \frac{\pi}{4e^n} \frac{\sinh n}{\sinh 1}$, n being a positive integer.

44. Starting with $\int_0^1 x^p dx = \frac{1}{p+1}$, deduce $\int_0^1 \frac{x^p - x^q}{\log x} dx = \log \frac{p+1}{q+1}$.

Putting $p = a\sqrt{-1}$ and $q = b\sqrt{-1}$, deduce the values of the integrals

$$\int_0^\infty e^{-t} \frac{\cos bt - \cos at}{t} dt \quad \text{and} \quad \int_0^\infty e^{-t} \frac{\sin bt - \sin at}{t} dt,$$

and verify your results by a rigorous independent method.

Show that $\int_0^1 \frac{\sin(p \log x)}{\log x} dx = \tan^{-1} p$.

45. Prove that

$$\int_0^1 \log \cos\left(\frac{\pi}{2} \sqrt{1-x^2}\right) dx = \log \frac{\pi}{4} - 2 \left\{ 1 - \frac{1}{3} \frac{a_1}{2^3} + \frac{1}{5} \frac{a_2}{2^5} - \dots \right\},$$

where $a_n = \sum_{r=1}^{\infty} \left\{ \frac{1}{r(r+1)} \right\}^n$. [ST. JOHN'S, 1885.]

46. Prove that $\int_0^\infty (e^{-\frac{p^2}{x^2}} - e^{-\frac{q^2}{x^2}}) dx = \sqrt{\pi}(q-p)$. [MATH. TRIPOS.]

47. Prove that

$$\int_0^{\frac{\pi}{2}} \phi(\sin 2x) \cos x dx = \int_0^{\frac{\pi}{2}} \phi(\cos^2 x) \cos x dx.$$

[BESGE, *Liouville's Journal*, xviii.]

48. Deduce from Laplace's Integral

$$\int_0^\infty dx e^{-\left(x^2 + \frac{a^2}{x^2}\right)} = \frac{\sqrt{\pi}}{2} e^{-2a},$$

the results *

$$\int_0^\infty \cos\left(x^2 + \frac{a^2}{x^2}\right) dx = \frac{\sqrt{\pi}}{2} \cos\left(\frac{\pi}{4} + 2a\right),$$

$$\int_0^\infty \sin\left(x^2 + \frac{a^2}{x^2}\right) dx = \frac{\sqrt{\pi}}{2} \sin\left(\frac{\pi}{4} + 2a\right),$$

$$\int_0^\infty e^{-\left(x^2 + \frac{a^2}{x^2}\right) \cos \theta} \cos\left\{\left(x^2 + \frac{a^2}{x^2}\right) \sin \theta\right\} dx = \frac{\sqrt{\pi}}{2} e^{-2a \cos \theta} \cos\left(2a \sin \theta + \frac{\theta}{2}\right)$$

$$\int_0^\infty e^{-\left(x^2 + \frac{a^2}{x^2}\right) \cos \theta} \sin\left\{\left(x^2 + \frac{a^2}{x^2}\right) \sin \theta\right\} dx = \frac{\sqrt{\pi}}{2} e^{-2a \cos \theta} \sin\left(2a \sin \theta + \frac{\theta}{2}\right).$$

[CAUCHY, *Mém. des Sav. Ét.*]

49. From Laplace's Integral

$$\int_0^\infty e^{-a^2 x^2} \cos 2rx dx = \frac{\sqrt{\pi}}{2a} e^{-\frac{r^2}{a^2}},$$

deduce *

$$\int_0^\infty \cos a^2 x^2 \cos 2rx dx = \frac{\sqrt{\pi}}{2a} \cos\left(\frac{\pi}{4} - \frac{r^2}{a^2}\right),$$

$$\int_0^\infty \sin a^2 x^2 \cos 2rx dx = \frac{\sqrt{\pi}}{2a} \sin\left(\frac{\pi}{4} - \frac{r^2}{a^2}\right).$$

[FOURIER, *T. de la Chal.*]

50. Prove that if $f^{(r)}(z) \equiv \left(\frac{d}{dz}\right)^r f(z)$, and all the differential coefficients up to the $(r-1)^{\text{th}}$ inclusive remain continuous from $z = -1$ to $z = 1$, then will

$$\int_0^\pi f^{(r)}(\cos x) \sin^{2r} x dx = 1.3.5 \dots (2r-1) \int_0^\pi f(\cos x) \cos rx dx.$$

[JACOBI, *Crelle's J.*, xv. ; GREGORY, *Examples*, p. 501.]

* See remarks on the use of imaginaries (Arts. 1189 to 1201),

51. Prove that

$$a \int_0^{-a} (t^2 - a^2)^m \cos tx \, dt = 2^m m! \left(\frac{1}{x} \frac{d}{dx} \right)^{m+1} \cos ax,$$

m being a positive integer.

[CULLEN, *Educ. Times*, 14808.]

52. Prove that

$$\int_0^\infty \frac{\sin\left(\frac{r\pi}{2} + ax\right)}{x^{n-r}} dx = \frac{(n-1)(n-2)\dots(n-r)}{\Gamma(n)} \frac{\pi a^{n-r-1}}{2 \sin \frac{n\pi}{2}},$$

r being an integer and $1 > n > 0$. [U. C. GHOSH, *Educ. Times*, 14954.]

53. Show that if

$$A = \int_0^\infty e^{-ax^2} \cos bx^2 dx, \quad B = \int_0^\infty e^{-ax^2} \sin bx^2 dx \quad (a > 0),$$

then $A^2 + B^2$ and $2AB$ can be expressed in terms of elementary functions.

[MATH. TRIPOS, PT. II., 1914.]

54. Show that
$$\int_0^\infty \left(\frac{\tan^{-1} x}{x} \right)^3 dx = \frac{1}{2} \pi \left(3 \log_e 2 - \frac{1}{8} \pi^2 \right).$$

[MATH. TRIPOS, PT. I., 1887.]

55. If
$$\sin x = x - \frac{x^3}{3!} + \frac{x^5}{5!} - \dots + (-1)^n \frac{x^{2n}}{(2n)!} X$$

and
$$\cos x = 1 - \frac{x^2}{2!} + \frac{x^4}{4!} - \dots + (-1)^n \frac{x^{2n-1}}{(2n-1)!} X',$$

prove that
$$\int_0^\infty \frac{X}{x} dx = \frac{\pi}{2} = \int_0^\infty \frac{X'}{x} dx.$$

[MATH. TRIPOS, 1875.]

56. If a and y be positive, prove that the value of

$$\int_0^\infty \frac{\sin(yx) \cos(ax)}{x} dx$$

is $\frac{1}{2}\pi$ or 0 according as y is greater or less than a .

By multiplying by $e^{-by} \cos cy$ and integrating with respect to y from a to ∞ , or otherwise, prove that

$$\int_0^\infty \frac{(x^2 + b^2 - c^2) \cos ax}{(x^2 + b^2 - c^2)^2 + 4b^2c^2} dx = \frac{1}{2} \pi e^{-ab} \frac{b \cos ac - c \sin ac}{b^2 + c^2},$$

a, b, c being positive constants.

[MATH. TRIPOS, PT. II., 1920.]

57. Show that
$$\int_{-\frac{\pi}{4}}^{\frac{\pi}{4}} \frac{(\pi - 4\theta) \tan \theta}{1 - \tan \theta} d\theta = \pi \left(\log 2 - \frac{\pi}{4} \right).$$

[TRIN. HALL and MAGD. COLL., 1881.]

58. Show that if α is positive and less than π ,

$$\int_0^\pi \log \frac{(1 + \sin \alpha \sin \theta)^{1 - \sin \alpha \sin \theta} d\theta}{(1 - \sin \alpha \sin \theta)^{1 + \sin \alpha \sin \theta} \theta} = \pi \left(\alpha - 2 \sin \alpha \log \cos \frac{\alpha}{2} \right).$$

[MATH. TRIP., PT. II, 1884.]

59. Prove that

$$\begin{aligned} \int_0^\pi \frac{\log \sin \theta}{\sqrt{\sin \theta}} d\theta &= 4 \int_0^{\frac{\pi}{2}} \frac{\log \sin \theta}{\sqrt{1 + \sin^2 \theta}} d\theta \\ &= -\frac{(\Gamma_4^1)^2}{4\sqrt{2}\pi} \left\{ 2 + \frac{1}{2} \cdot \frac{2 \cdot 6}{3 \cdot 7} + \frac{1}{3} \cdot \frac{2 \cdot 6 \cdot 10}{3 \cdot 7 \cdot 11} + \dots \right\}. \end{aligned}$$

(For other similar results, see G. H. Hardy, *Educ. T.*, 14055.)

60. Show that

$$\int_0^1 \int_0^1 f(xy)(1-x)^{\mu-1} y^\mu (1-y)^{\nu-1} dx dy = \frac{\Gamma(\mu)\Gamma(\nu)}{\Gamma(\mu+\nu)} \int_0^1 f(z)(1-z)^{\mu+\nu-1} dz.$$

[MATH. TRIP., PT. I., 1894.]

61. If

$$J_n(x) = \frac{x^n}{2^n \Gamma(n+1)} \left\{ 1 - \frac{x^2}{2(2n+2)} + \frac{x^4}{2 \cdot 4(2n+2)(2n+4)} - \dots \right\}, \quad (n > -1),$$

viz. Bessel's function, show that

$$(i) \quad J_n(x) = \frac{x^n}{2^n \sqrt{\pi} \Gamma(n + \frac{1}{2})} \int_0^\pi \cos(x \cos \phi) \sin^{2n} \phi d\phi, \quad \text{if } n > -\frac{1}{2},$$

and (ii) $J_n(x) = \frac{1}{\pi} \int_0^\pi \cos(n\phi - x \sin \phi) d\phi$, where n is a positive integer.

CHAPTER XXVII.

DEFINITE INTEGRALS (II.).

LOGARITHMIC AND EXPONENTIAL FUNCTIONS INVOLVED.

1071. In the class of definite integrals we are about to discuss, it will be convenient to remember the result

$$\int_0^1 x^p (\log x)^n dx = (-1)^n \frac{n!}{(p+1)^{n+1}}.$$

This is the result of integration by parts,

$$\begin{aligned} \int_0^1 x^p (\log x)^n dx &= \left[\frac{x^{p+1}}{p+1} (\log x)^n \right]_0^1 - \frac{n}{p+1} \int_0^1 x^p (\log x)^{n-1} dx \\ &= -\frac{n}{p+1} \int_0^1 x^p (\log x)^{n-1} dx \\ &= (-1)^2 \frac{n(n-1)}{(p+1)^2} \int_0^1 x^p (\log x)^{n-2} dx = \text{etc.} \\ &= (-1)^n \frac{n!}{(p+1)^{n+1}}. \end{aligned}$$

Or we might obtain the same result by the transformation $x = e^{-y}$, viz.

$$\begin{aligned} \int_0^1 x^p (\log x)^n dx &= \int_{\infty}^0 e^{-py} (-1)^n y^n (-e^{-y}) dy = (-1)^n \int_0^{\infty} y^n e^{-(p+1)y} dy \\ &= (-1)^n \frac{\Gamma(n+1)}{(p+1)^{n+1}} = (-1)^n \frac{n!}{(p+1)^{n+1}}, \end{aligned}$$

including the case $\int_0^1 (\log x)^n dx = (-1)^n \Gamma(n+1) = (-1)^n n!$.

1072. Again, let $F(x) \equiv A_0 + A_1 x + A_2 x^2 + A_3 x^3 + \dots$ be supposed a convergent series for all values of x between $x=0$ and $x=1$, and such that

$$Lt_{x \rightarrow 1} F(x) \left(\log \frac{1}{x} \right)^p \text{ is zero or finite when } x=1,$$

so that even when the series for $F(x)$ ceases to be convergent when $x=1$, the final element of the summation indicated by the integration $\int_0^1 F(x) \left(\log \frac{1}{x}\right)^p dx$ will have no effect. Then we shall have, by putting $x=e^{-y}$,

$$I \equiv \int_0^1 \left(\log \frac{1}{x}\right)^p F(x) dx = \int_0^\infty y^p e^{-y} F(e^{-y}) dy$$

$$= 1 \cdot (p+1) \left(\frac{A_0}{1^{p+1}} + \frac{A_1}{2^{p+1}} + \frac{A_2}{3^{p+1}} + \dots \right),$$

and therefore I can be expressed in finite terms whenever $F(x)$ is such that this series is capable of summation.

An extensive class of definite integrals arises from this fact.

1073. It will be well to recount several previous results obtained. We have now used the symbol S_p to denote the complete series

$$S_p \equiv \frac{1}{1^p} + \frac{1}{2^p} + \frac{1}{3^p} + \frac{1}{4^p} + \frac{1}{5^p} + \dots \text{ ad inf. } (\rho > 1),$$

and the numerical values of S_p up to S_{35} are tabulated in Art. 957.

Also, if $\sec x + \tan x = 1 + K_1 \frac{x}{1!} + K_2 \frac{x^2}{2!} + K_3 \frac{x^3}{3!} + \dots$, then

$$K_n \cdot \frac{\pi^{n+1}}{2^{n+2} n!} = 1 + \left(-\frac{1}{3}\right)^{n+1} + \left(\frac{1}{5}\right)^{n+1} + \left(-\frac{1}{7}\right)^{n+1} + \left(\frac{1}{9}\right)^{n+1} + \dots \text{ ad inf.},$$

and rules were given (*Diff. Calc.*, Art. 573) for the calculation of K_n , the results being

$$K_1 = 1, \quad K_2 = 1, \quad K_3 = 2, \quad K_4 = 5, \quad K_5 = 16,$$

$$K_6 = 61, \quad K_7 = 272, \quad K_8 = 1385, \quad K_9 = 7936, \quad \text{etc.},$$

K_{2n} being the n^{th} "Eulerian" number $\equiv E_{2n}$; whilst K_{2n-1} is the n^{th} "Prepared Bernoullian" number $\equiv \frac{2^{2n}(2^{2n}-1)}{2n} B_{2n-1}$, B_{2n-1} being the n^{th} Bernoullian number itself.

Also we have seen that

$$S_{2n} \equiv \frac{\pi^{2n}}{2(2n-1)!(2^{2n}-1)} K_{2n-1} \equiv \frac{1}{1^{2n}} + \frac{1}{2^{2n}} + \frac{1}{3^{2n}} + \frac{1}{4^{2n}} + \dots = \frac{(2\pi)^{2n}}{2(2n)!} B_{2n-1},$$

$$\frac{\pi^{2n+1}}{2^{2n+2}(2n)!} K_{2n} \equiv \frac{1}{1^{2n+1}} - \frac{1}{3^{2n+1}} + \frac{1}{5^{2n+1}} - \frac{1}{7^{2n+1}} + \dots = \frac{\pi^{2n+1}}{2^{2n+2}(2n)!} E_{2n},$$

and we have the particular results

$$\frac{1}{1} - \frac{1}{3} + \frac{1}{5} - \dots = \frac{\pi}{4} \text{ (Euler)} \qquad \frac{1}{1^4} + \frac{1}{2^4} + \frac{1}{3^4} + \dots = \frac{\pi^4}{90} \text{ (Euler)}$$

$$\frac{1}{1^8} - \frac{1}{3^8} + \frac{1}{5^8} - \dots = \frac{\pi^8}{32} \text{ (Tchebechef)} \qquad \frac{1}{1^8} + \frac{1}{3^8} + \frac{1}{5^8} + \dots = \frac{\pi^8}{8} \text{ (Euler)}$$

$$\frac{1}{1^8} - \frac{1}{3^8} + \frac{1}{5^8} - \dots = \frac{5\pi^8}{1536} \text{ (Tchebechef)} \qquad \frac{1}{1^4} + \frac{1}{3^4} + \frac{1}{5^4} + \dots = \frac{\pi^4}{96} \text{ (Euler)}$$

$$\frac{1}{1^8} + \frac{1}{2^8} + \frac{1}{3^8} + \dots = \frac{\pi^8}{6} \text{ (Euler)} \qquad \frac{1}{1} - \frac{1}{2} + \frac{1}{3} - \frac{1}{4} + \dots = \log 2$$

$$\left. \begin{aligned} s_p &\equiv \frac{1}{1^p} + \frac{1}{3^p} + \frac{1}{5^p} + \frac{1}{7^p} + \dots = \left(1 - \frac{1}{2^p}\right) S_p \\ \sigma_p &\equiv \frac{1}{1^p} - \frac{1}{2^p} + \frac{1}{3^p} - \frac{1}{4^p} + \dots = \left(1 - \frac{2}{2^p}\right) S_p \end{aligned} \right\} (p > 1).$$

1074. One class of series of this nature will not be obtainable from the tabulated results of Art. 957, viz.

$$\frac{1}{1^{2n}} - \frac{1}{3^{2n}} + \frac{1}{5^{2n}} - \frac{1}{7^{2n}} + \frac{1}{9^{2n}} - \dots \equiv s'_{2n}, \text{ say ;}$$

and so far as the author is aware the values of this series for various values of n have not been tabulated, and it would appear that there is no method of obtaining the values except from the series itself or from some transformation of it to render it more rapidly convergent. The most troublesome case for direct calculation is the case when $n=1$, on account of the slow rate of convergence. But in this isolated case, viz.

$$s'_2 \equiv \frac{1}{1^2} - \frac{1}{3^2} + \frac{1}{5^2} - \frac{1}{7^2} + \frac{1}{9^2} - \dots,$$

the value has been shown by Mr. J. W. L. Glaisher to be

$$0.91596 \ 55941 \ 77219 \ 01505 \ \dots$$

(*Proceedings of the London Math. Soc.*, 1876-7.)

Mr. Glaisher arrived at this result by means of the identity

$$\frac{t}{\sin t \cos t} = \sec^2 t - \frac{1}{3} \tan^2 t \sec^2 t + \frac{1}{5} \tan^4 t \sec^2 t - \dots,$$

a form of Gregory's series, which upon integration yields

$$\begin{aligned} \tan x - \frac{1}{3^2} \tan^3 x + \frac{1}{5^2} \tan^5 x - \dots &= \int_0^x \frac{2t}{\sin 2t} dt = \frac{1}{2} \int_0^{2x} \frac{T}{\sin T} dT \\ &= \frac{1}{2} \int_0^{2x} \left[1 - \frac{2T^2}{T^2 - \pi^2} + \frac{2T^2}{T^2 - 2^2\pi^2} - \dots \right] dT, \end{aligned}$$

and expanding the fractions in powers of T and integrating,

$$= x + \frac{1}{3} \frac{\sigma_2}{\pi^2} (2x)^2 + \frac{1}{5} \frac{\sigma_4}{\pi^4} (2x)^4 + \dots,$$

where
$$\sigma_{2n} = \frac{1}{1^{2n}} - \frac{1}{2^{2n}} + \frac{1}{3^{2n}} - \frac{1}{4^{2n}} + \dots = \left(1 - \frac{2}{2^{2n}}\right) S_{2n};$$

whence, putting $\frac{\pi x}{2}$ for x , Mr. Glaisher obtained the remarkable series

$$\tan \frac{\pi x}{2} - \frac{1}{3^2} \tan^3 \frac{\pi x}{2} + \frac{1}{5^2} \tan^5 \frac{\pi x}{2} - \dots = \frac{\pi}{2} \left[x + \frac{2}{3} \sigma_2 x^3 + \frac{2}{5} \sigma_4 x^5 + \dots \right],$$

and putting $x = \frac{1}{2}$, $s_2' = \frac{1}{1^2} - \frac{1}{3^2} + \frac{1}{5^2} - \frac{1}{7^2} + \dots = \frac{\pi}{2} \left[\frac{1}{2} + \frac{1}{3} \sigma_2 + \frac{1}{5} \sigma_4 + \dots \right],$

whence the value above given may be derived. The details of the calculation are given in Mr. Glaisher's paper (*loc. cit.*).

1075. It is to be remarked that in approximating to a case of the general series $\frac{1}{1^n} - \frac{1}{3^n} + \frac{1}{5^n} - \frac{1}{7^n} + \dots$, if we retain any specified number of terms, the error in rejecting the remainder of the series is less than the first of the rejected terms. *E.g.* if

$$s_2' = \frac{1}{1^2} - \frac{1}{3^2} + \frac{1}{5^2} - \frac{1}{7^2} + \epsilon, \quad \text{say,}$$

then
$$\epsilon = \frac{1}{9^2} - \left(\frac{1}{11^2} - \frac{1}{13^2} \right) - \text{etc.}, \quad \text{and } \therefore \text{ is } < \frac{1}{9^2};$$

and since
$$\epsilon = \left(\frac{1}{9^2} - \frac{1}{11^2} \right) + \left(\frac{1}{13^2} - \frac{1}{15^2} \right) + \dots, \quad \text{it is } > 0,$$

and the error in taking 4 terms lies between 0 and $\frac{1}{9^2}$. Similarly, and more generally, if we retain r terms the error is less than the $(r+1)^{\text{th}}$ term.

The series for s_4' , s_6' , etc., are much more rapidly convergent than that for s_2' , and therefore the calculations direct from the series are much less laborious.

For immediate convenience we may note that to six figures

$$\begin{aligned} s_2' &= \cdot 915,966, & s_4' &= \cdot 988,944, \\ s_6' &= \cdot 998,685, & s_8' &= \cdot 999,850. \end{aligned}$$

1076. The integrals which follow are arranged in groups according to their forms. Where it is thought necessary the working is fully given. In some cases two or three of the steps are given, and in other cases merely the result is stated. It is intended that these should be WORKED BY THE STUDENT FOR HIS OWN PRACTICE. In some cases it will be seen that by treatment of the same integral by different methods various identities may be established.

1077. GROUP A. EXAMPLES OF Integrals of form

$$\int_0^1 \frac{x^q \left(\log \frac{1}{x}\right)^p}{1 \pm x} dx.$$

1. $I = \int_0^1 \frac{\log \frac{1}{x}}{1-x} dx$. Putting $x = e^{-y}$, we have

$$I = \int_0^\infty y(e^{-y} + e^{-2y} + e^{-3y} + \dots) dy = \frac{1}{1^2} + \frac{1}{2^2} + \frac{1}{3^2} + \dots = \frac{\pi^2}{6}.$$

2. Show that $\int_0^1 \frac{\log \frac{1}{x}}{1+x} dx = \left(1 - \frac{2}{2^2}\right) \frac{\pi^2}{6} = \frac{\pi^2}{12}$.

3. Show that

$$\int_0^1 \frac{\left(\log \frac{1}{x}\right)^2}{1-x} dx = 2! \left(\frac{1}{1^3} + \frac{1}{2^3} + \frac{1}{3^3} + \dots\right) = 2S_3 = 2 \cdot 40411 \dots$$

4. Show that $\int_0^1 \frac{\left(\log \frac{1}{x}\right)^2}{1+x} dx = \frac{3}{2} S_3$.

5. Show that

$$\int_0^1 \frac{\left(\log \frac{1}{x}\right)^3}{1-x} dx = \frac{\pi^4}{15}, \quad \int_0^1 \frac{\left(\log \frac{1}{x}\right)^3}{1+x} dx = \frac{7\pi^4}{120}.$$

6. Show that

$$\int_0^1 \frac{\left(\log \frac{1}{x}\right)^{2n-1}}{1-x} dx = \frac{(2\pi)^{2n}}{4n} B_{2n-1}, \quad \int_0^1 \frac{\left(\log \frac{1}{x}\right)^{2n-1}}{1+x} dx = \frac{2^{2n-1} - 1}{2n} \pi^{2n} B_{2n-1}.$$

7. Show that

$$\int_0^1 \frac{\left(\log \frac{1}{x}\right)^{2n}}{1-x} dx = (2n)! S_{2n+1}, \quad \int_0^1 \frac{\left(\log \frac{1}{x}\right)^{2n}}{1+x} dx = (2n)! \frac{2^{2n} - 1}{2^{2n}} S_{2n+1}.$$

It is to be noted that integrals with integrands of the same character as the above multiplied by rational integral algebraic polynomials present no difficulty, thus :

8. $\int_0^1 x \frac{\log \frac{1}{x}}{1-x} dx = \int_0^\infty y(e^{-2y} + e^{-3y} + e^{-4y} + \dots) dy = \frac{1}{2^2} + \frac{1}{3^2} + \dots = \frac{\pi^2}{6} - \frac{1}{1^2}$.

9. Show that $\int_0^1 x^2 \frac{\log \frac{1}{x}}{1-x} dx = \frac{\pi^2}{6} - \frac{1}{1^2} - \frac{1}{2^2}$.

10. Show that

$$\int_0^1 (ax^2 + bx + c) \frac{\log \frac{1}{x}}{1-x} dx = (a+b+c) \frac{\pi^2}{6} - \frac{a+b}{1^2} - \frac{a}{2^2}.$$

1078. In some of the simpler cases, viz. when the power of the logarithmic factor is the first, we may write $1-y$ for x , and expand the logarithm.

Thus

$$\begin{aligned} \int_0^1 \frac{\log x}{1-x} dx &= \int_1^0 \frac{\log(1-y)}{y} (-1) dy = \int_0^1 \frac{\log(1-y)}{y} dy \\ &= -\int_0^1 \left(1 + \frac{y}{2} + \frac{y^2}{3} + \dots\right) dy = -\left(\frac{1}{1^2} + \frac{1}{2^2} + \frac{1}{3^2} + \dots\right) = -\frac{\pi^2}{6}. \end{aligned}$$

EXAMPLES.

1. Prove that $\int_0^1 \tanh^{-1} x \frac{dx}{x} = \frac{\pi^2}{8} = \int_0^a \tanh^{-1} \frac{x}{a} \frac{dx}{x}$.

2. Deduce from (2), Art. 1077, by putting $x = \tan^2 \theta$,

$$\int_0^{\frac{\pi}{4}} \tan \theta \log \cot \theta d\theta = \frac{\pi^2}{48}.$$

3. Deduce from (6), Art. 1077, by putting $x = \sin^2 \theta$,

$$\int_0^{\frac{\pi}{2}} \tan \theta (\log \operatorname{cosec} \theta)^{2n-1} d\theta = \frac{\pi^{2n}}{4n} B_{2n-1}.$$

4. Prove that

$$\int_0^{\frac{\pi}{4}} \tan \theta (\log \cot \theta)^{2n-1} d\theta = \frac{2^{2n-1} - 1}{2^{2n+1}} \frac{\pi^{2n}}{n} B_{2n-1}.$$

1079. GROUP B. EXAMPLES OF Integrals of form

$$\int_0^1 \frac{x^q \left(\log \frac{1}{x}\right)^p}{1 \pm x^2} dx.$$

Prove that

1. $\int_0^1 \frac{\log \frac{1}{x}}{1-x^2} dx = \frac{\pi^2}{8}$, $\int_0^1 \frac{\log \frac{1}{x}}{1+x^2} dx = s_2' = .915966\dots$ approximately.

2. $\int_0^1 \frac{\left(\log \frac{1}{x}\right)^2}{1-x^2} dx = 2 \left(1 - \frac{1}{2^3}\right) S_3 = 2 \cdot 103599\dots$, $\int_0^1 \frac{\left(\log \frac{1}{x}\right)^2}{1+x^2} dx = \frac{\pi^3}{16}$.

3. $\int_0^1 \frac{\left(\log \frac{1}{x}\right)^3}{1-x^2} dx = \frac{\pi^4}{16}$, $\int_0^1 \frac{\left(\log \frac{1}{x}\right)^3}{1+x^2} dx = 6s_4' = 5 \cdot 9336\dots$

4. $\int_0^1 \frac{\left(\log \frac{1}{x}\right)^4}{1-x^2} dx = 4! \left(1 - \frac{1}{2^5}\right) S_5 = 24 \cdot 10857\dots$, $\int_0^1 \frac{\left(\log \frac{1}{x}\right)^4}{1+x^2} dx = \frac{5\pi^5}{64}$.

$$5. \int_0^1 \frac{\left(\log \frac{1}{x}\right)^6}{1-x^2} dx = \frac{\pi^6}{8}, \quad \int_0^1 \frac{\left(\log \frac{1}{x}\right)^6}{1+x^2} dx = 5! s_6' = 119 \cdot 842 \dots$$

$$6. \int_0^1 \frac{\left(\log \frac{1}{x}\right)^6}{1-x^2} dx = 6! \left(1 - \frac{1}{2^7}\right) S_7, \quad \int_0^1 \frac{\left(\log \frac{1}{x}\right)^6}{1+x^2} dx = \frac{61\pi^7}{2^8}.$$

$$7. \int_0^1 \frac{\left(\log \frac{1}{x}\right)^{2n-1}}{1-x^2} dx = \frac{\pi^{2n}(2^{2n}-1)}{4n} B_{2n-1},$$

$$\int_0^1 \frac{\left(\log \frac{1}{x}\right)^{2n}}{1+x^2} dx = \frac{\pi^{2n+1}}{2^{2n+2}} E_{2n};$$

and in the same way as 8, 9, 10 of Group A, prove that

$$8. \int_0^1 x \frac{\log \frac{1}{x}}{1-x^2} dx = \frac{\pi^2}{24}. \quad [\text{EULER, } \textit{Nov. Com. Pet.,} \text{ vol. xix.}]$$

$$9. \int_0^1 x^2 \frac{\log \frac{1}{x}}{1-x^2} dx = \frac{\pi^2}{8} - 1.$$

$$10. \int_0^1 x^3 \frac{\log \frac{1}{x}}{1-x^2} dx = \frac{\pi^2}{24} - \frac{1}{4}, \text{ and so on for similar cases.}$$

11. Putting $x = \sin \theta$ in No. 7 (1st part) and $x = \tan \theta$ in No. 7 (2nd part), show that, if n be a positive integer,

$$(i) \int_0^{\frac{\pi}{2}} \sec \theta (\log \operatorname{cosec} \theta)^{n-1} d\theta = \int_0^{\frac{\pi}{4}} \operatorname{cosec} \theta (\log \sec \theta)^{n-1} d\theta \\ = \pi^{2n} \frac{2^{2n}-1}{4n} B_{2n-1};$$

$$(ii) \int_0^{\frac{\pi}{4}} (\log \cot \theta)^{2n} d\theta = \frac{\pi^{2n+1}}{2^{2n+2}} E_{2n}.$$

1080. GROUP C. EXAMPLES OF Integrals of type

$$\int_0^1 \frac{x^m \left(\log \frac{1}{x}\right)^p}{(1 \pm x)^q} dx,$$

p and q being positive integers ($p < q$).

1. Putting $x = e^{-y}$, we have

$$\int_0^1 \frac{\left(\log \frac{1}{x}\right)^p}{(1-x)^q} dx = \int_0^\infty y^p (e^{-y} + 2e^{-2y} + 3e^{-3y} + \dots) dy \\ = p! \left(\frac{1}{1^{p+1}} + \frac{2}{2^{p+1}} + \frac{3}{3^{p+1}} + \dots \right) = p! S_p \quad (p > 1).$$

Prove that

$$2. \int_0^1 \frac{\left(\log \frac{1}{x}\right)^p}{(1+x)^2} dx = p! \left(1 - \frac{2}{2^p}\right) S_p \quad (p > 1). \quad 3. \int_0^1 \frac{\log \frac{1}{x}}{(1+x)^2} dx = \log_e 2.$$

$$4. \int_0^1 \frac{\left(\log \frac{1}{x}\right)^p}{(1-x)^3} dx = \frac{p!}{2} (S_{p-1} + S_p).$$

$$5. \int_0^1 \frac{\left(\log \frac{1}{x}\right)^p}{(1-x)^4} dx = \frac{p!}{3} (S_{p-2} + 3S_{p-1} + 2S_p).$$

$$6. \int_0^1 \frac{\left(\log \frac{1}{x}\right)^p}{(1-x)^q} dx = \frac{p!}{(q-1)!} (S_{p-q+2} + P_1 S_{p-q+3} + \dots + P_{q-2} S_p),$$

where P_r is the sum of the products r at a time of 1, 2, 3, ... $(q-2)$.

$$7. \int_0^1 \frac{\left(\log \frac{1}{x}\right)^p}{(1+x)^q} dx = \frac{p!}{(q-1)!} (\sigma_{p-q+2} + P_1 \sigma_{p-q+3} + \dots + P_{q-2} \sigma_p),$$

where $\sigma_r = \frac{1}{1^r} - \frac{1}{2^r} + \frac{1}{3^r} - \dots = \left(1 - \frac{2}{2^r}\right) S_r$.

$$8. \int_0^1 x^2 \frac{\left(\log \frac{1}{x}\right)^3}{(1-x^2)^2} dx = 3 \left(\frac{7}{8} S_3 - \frac{\pi^4}{96}\right), \quad \int_0^1 x^2 \frac{\left(\log \frac{1}{x}\right)^3}{(1+x^2)^2} dx = 3 \left(s_4' - \frac{\pi^3}{32}\right).$$

$$9. \int_0^{\frac{\pi}{4}} \frac{\log \cot \theta}{(\sin \theta + \cos \theta)^2} d\theta = \log 2. \quad (\text{Put } x = \tan \theta \text{ in 3.})$$

$$10. \int_0^{\frac{\pi}{4}} \sin 2\theta \log \cot \theta d\theta = \frac{1}{2} \log 2. \quad (\text{Put } x = \tan^2 \theta \text{ in 3.})$$

1081. GROUP D. Various Forms containing Radicals.

$$1. I = \int_0^1 \frac{\log \frac{1}{x}}{\sqrt{1-x}} dx = \int_0^\infty y \left(e^{-y} + \frac{1}{2} e^{-2y} + \frac{1 \cdot 3}{2 \cdot 4} e^{-3y} + \dots \right) dy \\ = \frac{1}{1^2} + \frac{1}{2} \cdot \frac{1}{2^2} + \frac{1 \cdot 3}{2 \cdot 4} \frac{1}{3^2} + \frac{1 \cdot 3 \cdot 5}{2 \cdot 4 \cdot 6} \cdot \frac{1}{4^2} + \dots$$

Again putting $x = \sin^2 \theta$,

$$I = - \int_0^{\frac{\pi}{2}} \log \sin^2 \theta \cdot 2 \sin \theta d\theta = -4 \int_0^{\frac{\pi}{2}} \sin \theta \log \sin \theta d\theta \\ = -4 \left[-\cos \theta \log \sin \theta + \log \tan \frac{\theta}{2} + \cos \theta \right]_0^{\frac{\pi}{2}} \\ = -4 \left[\cos \theta (1 - \log 2) + 2 \sin^2 \frac{\theta}{2} \log \sin \frac{\theta}{2} - 2 \cos^2 \frac{\theta}{2} \log \cos \frac{\theta}{2} \right]_0^{\frac{\pi}{2}} \\ = -4 [\log 2 - 1] = 4 \log \frac{e}{2}.$$

Thus we have the result

$$4 \log \frac{e}{2} = \frac{1}{1^2} + \frac{1}{2} \cdot \frac{1}{2^2} + \frac{1 \cdot 3}{2 \cdot 4} \cdot \frac{1}{3^2} + \frac{1 \cdot 3 \cdot 5}{2 \cdot 4 \cdot 6} \cdot \frac{1}{4^2} + \dots \text{ ad inf.}$$

$$2. I = \int_0^1 \frac{x^2 \log x}{\sqrt{1-x^2}} dx. \quad [\text{EULER, Nov. Com. Petropol., xix., p. 30.}]$$

Put $x = \sin \theta$, $I = \int_0^{\frac{\pi}{2}} \sin^2 \theta \log \sin \theta d\theta = \int_0^{\frac{\pi}{2}} \frac{1 - \cos 2\theta}{2} \log \sin \theta d\theta$

$$= \frac{1}{2} \int_0^{\frac{\pi}{2}} \log \sin \theta d\theta - \frac{1}{2} \left[\frac{\sin 2\theta}{2} \log \sin \theta \right]_0^{\frac{\pi}{2}} + \frac{1}{2} \int_0^{\frac{\pi}{2}} \cos^2 \theta d\theta$$

$$= \frac{\pi}{4} \log \frac{1}{2} + \frac{\pi}{8} = \frac{\pi}{8} \log \frac{e}{4}.$$

3. Find the values of

$$I = \int_0^{\frac{\pi}{2}} \cos 2n\theta \log \sin \theta d\theta \quad \text{and} \quad I' = \int_0^{\frac{\pi}{2}} \sin^{2n} \theta \log \sin \theta d\theta.$$

Since

$$\sin \theta \frac{d}{d\theta} \left\{ \theta + \sin 2\theta + \frac{1}{2} \sin 4\theta + \frac{1}{3} \sin 6\theta + \dots \right. \\ \left. + \frac{1}{n-1} \sin (2n-2)\theta + \frac{1}{2n} \sin 2n\theta \right\} = \sin 2n\theta \cos \theta,$$

we have

$$\int \sin 2n\theta \cot \theta d\theta = \theta + \sin 2\theta + \frac{\sin 4\theta}{2} + \dots + \frac{\sin (2n-2)\theta}{n-1} + \frac{\sin 2n\theta}{2n},$$

$$\text{also } \int \sin 2n\theta \cot \theta d\theta = \sin 2n\theta \log \sin \theta - 2n \int \cos 2n\theta \log \sin \theta d\theta.$$

$$\text{Hence} \quad I \equiv \int_0^{\frac{\pi}{2}} \cos 2n\theta \log \sin \theta d\theta = -\frac{\pi}{4n} \quad (n > 0).$$

Again

$$\sin^{2n} \theta = \frac{1}{2^{2n}} \{ {}^{2n}C_n - 2 {}^{2n}C_{n-1} \cos 2\theta + 2 {}^{2n}C_{n-2} \cos 4\theta - \dots + (-1)^n 2 \cos 2n\theta \}$$

$$\therefore I' \equiv \int_0^{\frac{\pi}{2}} \sin^{2n} \theta \log \sin \theta d\theta$$

$$= \frac{1}{2^{2n}} \left\{ {}^{2n}C_n \frac{\pi}{2} \log \frac{1}{2} - 2 {}^{2n}C_{n-1} \left(-\frac{\pi}{4} \right) + 2 {}^{2n}C_{n-2} \left(-\frac{\pi}{8} \right) - \dots + (-1)^n 2 \left(-\frac{\pi}{4n} \right) \right\}$$

$$= \frac{\pi}{2^{2n+1}} \left\{ {}^{2n}C_n \log \frac{1}{2} + {}^{2n}C_{n-1} - \frac{1}{2} {}^{2n}C_{n-2} + \frac{1}{3} {}^{2n}C_{n-3} - \dots + (-1)^{n-1} \frac{1}{n} {}^{2n}C_0 \right\}.$$

Putting $\sin \theta = x$, we have the value of $\int_0^1 \frac{x^{2n} \log x}{\sqrt{1-x^2}} dx$.

$$4. I = \int_0^1 \frac{\log \frac{r}{x}}{\sqrt{1-x^2}} dx = \int_0^\infty y \left(e^{-y} + \frac{1}{2} e^{-3y} + \frac{1 \cdot 3}{2 \cdot 4} e^{-5y} + \dots \right) dy$$

$$= \frac{1}{1^2} + \frac{1}{2} \cdot \frac{1}{3^2} + \frac{1 \cdot 3}{2 \cdot 4} \cdot \frac{1}{5^2} + \dots$$

Again putting $x = \sin \theta$,

$$\int_0^1 \frac{\log \frac{1}{x}}{\sqrt{1-x^2}} dx = - \int_0^{\frac{\pi}{2}} \log \sin \theta d\theta = \frac{\pi}{2} \log 2 ;$$

whence it appears that

$$\frac{\pi}{2} \log 2 = \frac{1}{1^2} + \frac{1}{2} \cdot \frac{1}{3^2} + \frac{1 \cdot 3}{2 \cdot 4} \cdot \frac{1}{5^2} + \frac{1 \cdot 3 \cdot 5}{2 \cdot 4 \cdot 6} \cdot \frac{1}{7^2} + \dots$$

1082. GROUP E. Cases in which the Algebraic Factor is the Generating Function of a Recurring Series whose Coefficients are Powers of the Natural Numbers.

$$\begin{aligned} 1. \int_0^1 \frac{1+x}{(1-x)^3} \left(\log \frac{1}{x}\right)^3 dx &= \int_0^\infty y^3 (e^{-y} + e^{-2y}) \left(1 + 3e^{-y} + \frac{3 \cdot 4}{1 \cdot 2} e^{-2y} + \dots\right) dy \\ &= \int_0^\infty y^3 (e^{-y} + 2^2 e^{-2y} + 3^2 e^{-3y} + \dots) dy \\ &= 3! \left(\frac{1^2}{1^4} + \frac{2^2}{2^4} + \frac{3^2}{3^4} + \dots\right) = 6 \cdot \frac{\pi^2}{6} = \pi^2. \end{aligned}$$

Prove that

$$2. \int_0^1 \frac{1+x}{(1-x)^4} \left(\log \frac{1}{x}\right)^5 dx = \frac{1}{3} \pi^4, \quad \int_0^1 \frac{1+x}{(1-x)^3} \left(\log \frac{1}{x}\right)^7 dx = \frac{1}{9} \pi^6,$$

$$\int_0^1 \frac{1+x}{(1-x)^3} \left(\log \frac{1}{x}\right)^{2n+1} dx = \frac{2n+1}{2} (2\pi)^{2n} B_{2n-1}.$$

$$3. \int_0^1 \frac{1+6x^2+x^4}{(1-x^2)^3} \left(\log \frac{1}{x}\right)^3 dx = \frac{3\pi^2}{4},$$

$$\int_0^1 \frac{1+6x^2+x^4}{(1-x^2)^3} \left(\log \frac{1}{x}\right)^{2n+1} dx = \frac{2n+1}{2} (2^{2n}-1) \pi^{2n} B_{2n-1}.$$

$$\begin{aligned} 4. \int_0^1 \frac{(1+x)(1+10x+x^2)}{(1-x)^6} \left(\log \frac{1}{x}\right)^{2n+3} dx \\ = \frac{(2n+3)(2n+2)(2n+1)}{2} (2\pi)^{2n} B_{2n-1}. \end{aligned}$$

$$5. \int_0^1 \frac{1+x^2}{(1-x^2)^2} (\log x)^2 dx = \frac{\pi^2}{4}.$$

$$6. \int_0^1 \frac{1+26x+66x^2+26x^3+x^4}{(1-x)^6} \left(\log \frac{1}{x}\right)^5 dx = 2^6 \cdot 7 \cdot \pi^4.$$

$$7. \int_0^1 \frac{x}{(1-x)^4} \left(\log \frac{1}{x}\right)^4 dx = \frac{2}{45} \pi^2 (15 - \pi^2),$$

$$\int_0^1 \frac{1+x^2}{(1-x)^4} \left(\log \frac{1}{x}\right)^4 dx = \frac{4\pi^2}{45} (15 + 2\pi^2).$$

$$8. \int_0^1 \frac{1+4x+x^2}{(1-x)^4} \left(\log \frac{1}{x}\right)^{2n+3} dx = (n+1)(2n+1)(2\pi)^{2n} B_{2n-1}.$$

$$9. \int_0^1 \frac{1+x^4}{(1-x)^6} \left(\log \frac{1}{x}\right)^6 dx = 2\pi^2 \left(1 + \frac{7}{3}\pi^2 + \frac{1}{15}\pi^4\right).$$

10. If $a_0, a_1, a_2, \dots, a_{n-1}$ be defined by the equation

$$a_{r-1} = s^n - {}^{n+1}C_1(s-1)^n + {}^{n+1}C_2(s-2)^n - \dots + (-1)^{r-1} {}^{n+1}C_{r-1} \cdot 1^n$$

for all values of s from $s=1$ to $s=n$, then

$$\int_0^1 \frac{a_0 + a_1 x + a_2 x^2 + \dots + a_{n-1} x^{n-1}}{(1-x)^{n+1}} \left(\log \frac{1}{x} \right)^{n+2m-1} dx \\ = \frac{1}{2} \frac{(n+2m-1)!}{(2m)!} (2\pi)^{2m} B_{2m-1}.$$

It will be recognised that the several equations defining the letters $a_0, a_1, a_2, \dots, a_{n-1}$, viz.

$$a_0 = 1^n, \quad a_1 = 2^n - (n+1)1^n, \quad a_2 = 3^n - (n+1)2^n + \frac{(n+1)n}{1 \cdot 2} 1^n, \\ \text{etc.,}$$

$$a_{n-1} = n^n - (n+1)(n-1)^n + \frac{(n+1)n}{1 \cdot 2} (n-2)^n - \dots + (-1)^{n-1} \frac{(n+1)n}{1 \cdot 2} 1^n,$$

are the results of equating coefficients in

$a_0 + a_1 x + a_2 x^2 + \dots + a_{n-1} x^{n-1} \equiv (1^n + 2^n x + 3^n x^2 + \dots \text{ ad. inf.}) (1-x)^{n+1}$
up to the coefficient of x^{n-1} . And it is known that

$$(n+r)^n - {}^{n+1}C_1(n+r-1)^n + \dots + (-1)^{n+1} {}^{n+1}C_{n+1}(r-1)^n$$

vanishes for all values of r from 1 to ∞ , being the coefficient of x^n in

$$e^{(r-1)x} (e^{2x} - 1)^{n+1}, \quad \text{i.e. in } [1 + (r-1)x + \dots] (e^{n+1} - \dots),$$

in which the term of lowest degree is x^{n+1} .

Hence $\frac{a_0 + a_1 x + a_2 x^2 + \dots + a_{n-1} x^{n-1}}{(1-x)^{n+1}}$ is the generating function of the recurring series $1^n + 2^n x + 3^n x^2 + \dots$.

$$\text{Therefore } \int_0^1 \frac{a_0 + a_1 x + a_2 x^2 + \dots + a_{n-1} x^{n-1}}{(1-x)^{n+1}} \left(\log \frac{1}{x} \right)^{n+2m-1} dx \\ = \int_0^\infty y^{n+2m-1} [1^n e^{-y} + 2^n e^{-2y} + 3^n e^{-3y} + \dots] dy \\ = (n+2m-1)! \left[\frac{1^n}{1^{n+2m}} + \frac{2^n}{2^{n+2m}} + \frac{3^n}{3^{n+2m}} + \dots \right] \\ = (n+2m-1)! \left[\frac{1}{1^{2m}} + \frac{1}{2^{2m}} + \frac{1}{3^{2m}} + \dots \right] \\ = (n+2m-1)! \frac{(2\pi)^{2m}}{2(2m)!} B_{2m-1}.$$

1083. GROUP F. Gaps in the Development of the Algebraic Factor.

Let α and β be any two prime numbers.

In the series formed by the development of

$$\frac{x}{1-x} - \frac{x^\alpha}{1-x^\alpha} - \frac{x^\beta}{1-x^\beta} \text{ in ascending powers of } x \quad (x < 1),$$

the subtraction of $\frac{x^a}{1-x^a}$, i.e. $x^a + x^{2a} + x^{3a} + \dots$, from $\frac{x}{1-x}$, i.e. the complete series

$$x + x^2 + x^3 + \dots + x^a + x^{a+1} + \dots + x^{2a} + x^{2a+1} + \dots,$$

removes all terms whose indices are multiples of a .

The subsequent subtraction of $\frac{x^\beta}{1-x^\beta}$ removes all those terms which remain, and have indices multiples of β , restoring with the opposite sign such terms as have indices multiples of $a\beta$.

If we now add $\frac{x^{a\beta}}{1-x^{a\beta}}$ we are left with the complete series with all terms whose indices contain either a or β as a factor removed.

Exactly analogous to this is the effect of multiplying the series

$$S = \frac{1}{1^p} + \frac{1}{2^p} + \frac{1}{3^p} + \frac{1}{4^p} + \frac{1}{5^p} + \dots, \quad (p > 1),$$

$$(1) \text{ by } 1 - \frac{1}{a^p} - \frac{1}{\beta^p}, \quad (2) \text{ by } \left(1 - \frac{1}{a^p}\right)\left(1 - \frac{1}{\beta^p}\right).$$

For $S - \frac{S}{a^p} - \frac{S}{\beta^p} \equiv$ the complete series S from which terms in which the denominators are multiples of a and β have been removed, but those whose denominators contain both a and β are restored with the opposite sign, whilst in the case $S\left(1 - \frac{1}{a^p}\right)\left(1 - \frac{1}{\beta^p}\right)$, no terms occur whose denominators contain either a or β as a factor.

$$\begin{aligned} \text{Thus} \quad I &= \int_0^1 \left(\frac{x}{1-x} - \frac{x^a}{1-x^a} - \frac{x^\beta}{1-x^\beta} \right) \left(\log \frac{1}{x} \right)^{2n-1} \frac{dx}{x} \\ &= (2n-1)! \left[\left\{ \frac{1}{1^{2n}} + \frac{1}{2^{2n}} + \frac{1}{3^{2n}} + \dots \right\} \right], \end{aligned}$$

by putting $x = e^{-y}$ as usual, where the double bracket indicates that from the series included all terms have been removed which contain a and not β , or β and not a , as a factor, whilst terms with both a and β as a factor occur with the negative sign

$$\begin{aligned} &= (2n-1)! \left(1 - \frac{1}{a^p} - \frac{1}{\beta^p} \right) S_{2n} \\ &= (2n-1)! \left(1 - \frac{1}{a^p} - \frac{1}{\beta^p} \right) \frac{(2\pi)^{2n}}{2(2n)!} B_{2n-1} \\ &= \left(1 - \frac{1}{a^p} - \frac{1}{\beta^p} \right) \frac{(2\pi)^{2n}}{4n} B_{2n-1}. \end{aligned}$$

$$\begin{aligned} \text{And} \quad I' &= \int_0^1 \left(\frac{x}{1-x} - \frac{x^a}{1-x^a} - \frac{x^\beta}{1-x^\beta} + \frac{x^{a\beta}}{1-x^{a\beta}} \right) \left(\log \frac{1}{x} \right)^{2n-1} \frac{dx}{x} \\ &= \left(1 - \frac{1}{a^p} \right) \left(1 - \frac{1}{\beta^p} \right) \frac{(2\pi)^{2n}}{4n} B_{2n-1}. \end{aligned}$$

It may be noted that

$$\begin{aligned} \int_0^1 \frac{x^\alpha}{1-x^\alpha} \left(\log \frac{1}{x}\right)^{2n-1} \frac{dx}{x} &= \frac{1}{\alpha^{2n}} \int_0^1 \frac{y}{1-y} \left(\log \frac{1}{y}\right)^{2n-1} \frac{dy}{y} \\ &= \frac{1}{\alpha^{2n}} \int_0^1 \frac{x}{1-x} \left(\log \frac{1}{x}\right)^{2n-1} \frac{dx}{x}, \end{aligned}$$

and therefore

$$\begin{aligned} \int_0^1 \left(\frac{x}{1-x} - \frac{Px^\alpha}{1-x^\alpha} - \frac{Qx^\beta}{1-x^\beta} + \frac{Rx^{\alpha\beta}}{1-x^{\alpha\beta}} \right) \left(\log \frac{1}{x}\right)^{2n-1} \frac{dx}{x} \\ = \left(1 - \frac{P}{\alpha^{2n}} - \frac{Q}{\beta^{2n}} + \frac{R}{\alpha^{2n}\beta^{2n}} \right) \frac{(2\pi)^{2n}}{4n} B_{2n-1}, \end{aligned}$$

whatever numerical values may be assigned to P, Q, R .

And more generally, if $\alpha, \beta, \gamma, \dots$ be any prime numbers, and if $F(x)$ be the function of x which would be formed by first developing

$$(1-A)(1-B)(1-C)(1-D) \dots \text{ as } 1 - (A+B+\dots) + (AB+\dots) - \text{etc.},$$

and then replacing

$$1 \text{ by } \frac{x}{1-x}, \quad A \text{ by } \frac{x^\alpha}{1-x^\alpha}, \quad B \text{ by } \frac{x^\beta}{1-x^\beta}, \text{ etc.},$$

$$AB \text{ by } \frac{x^{\alpha\beta}}{1-x^{\alpha\beta}}, \quad ABC \text{ by } \frac{x^{\alpha\beta\gamma}}{1-x^{\alpha\beta\gamma}}, \text{ and so on,}$$

then $F(x)$ consists of such terms of the series $x+x^2+x^3+x^4+\dots$ as are left when all those are removed which have α, β, γ or any combination of them as a factor of their indices; and then

$$\int_0^1 F(x) \left(\log \frac{1}{x}\right)^{2n-1} \frac{dx}{x} = \int_0^\infty y^{2n-1} (e^{-y} + e^{-2y} + \dots) dy,$$

where the terms in the bracket are such that those whose indices are multiples of any of the primes $\alpha, \beta, \gamma, \dots$ are missing,

$$= (2n-1)! \left(1 - \frac{1}{\alpha^{2n}}\right) \left(1 - \frac{1}{\beta^{2n}}\right) \left(1 - \frac{1}{\gamma^{2n}}\right) \dots S_{2n},$$

$$\text{i.e. } \int_0^1 F(x) \left(\log \frac{1}{x}\right)^{2n-1} \frac{dx}{x} = \frac{(2\pi)^{2n}}{4n} B_{2n-1} \left(1 - \frac{1}{\alpha^{2n}}\right) \left(1 - \frac{1}{\beta^{2n}}\right) \left(1 - \frac{1}{\gamma^{2n}}\right) \dots$$

If we press the theorem further, and remove *all* the terms from $\frac{x}{1-x}$ except the first, then if $\alpha, \beta, \gamma, \dots$ be all the prime numbers,

$$\begin{aligned} \int_0^1 \left[\frac{x}{1-x} - \sum \frac{x^\alpha}{1-x^\alpha} + \sum \frac{x^{\alpha\beta}}{1-x^{\alpha\beta}} - \sum \frac{x^{\alpha\beta\gamma}}{1-x^{\alpha\beta\gamma}} + \sum \frac{x^{\alpha\beta\gamma\delta}}{1-x^{\alpha\beta\gamma\delta}} - \dots \text{ ad. inf.} \right] \left(\log \frac{1}{x}\right)^{2n-1} \frac{dx}{x} \\ = (2n-1)! \left(1 - \frac{1}{2^{2n}}\right) \left(1 - \frac{1}{3^{2n}}\right) \left(1 - \frac{1}{5^{2n}}\right) \left(1 - \frac{1}{7^{2n}}\right) \dots S_{2n} \\ = (2n-1)! \quad (\text{by Raabe's Theorem, } \textit{Diff. Calc.}, \text{ p. 109, Ex. 29}). \end{aligned}$$

And this result is *a priori* obvious, for the integral is merely

$$\int_0^1 x \left(\log \frac{1}{x}\right)^{2n-1} \frac{dx}{x} = \int_0^\infty e^{-y} y^{2n-1} dy = \Gamma(2n).$$

EXAMPLES.

1. Thus we have

$$\int_0^1 \left[\frac{x}{1-x} - \frac{x^2}{1-x^2} - \frac{x^3}{1-x^3} + \frac{x^5}{1-x^5} + \frac{x^6}{1-x^6} + \frac{x^{10}}{1-x^{10}} + \frac{x^{15}}{1-x^{15}} - \frac{x^{30}}{1-x^{30}} \right] \log \frac{1}{x} \cdot \frac{dx}{x}$$

$$= \left(1 - \frac{1}{2^2}\right) \left(1 - \frac{1}{3^2}\right) \left(1 - \frac{1}{5^2}\right) \frac{(2\pi)^2}{4} B_1 = \frac{3}{4} \cdot \frac{8}{9} \cdot \frac{24}{25} \cdot \frac{\pi^2}{6} = \frac{8\pi^2}{75}.$$

2. Prove that

(i) $\int_0^1 \frac{1+x}{1-x^2} \log \frac{1}{x} dx = \frac{4\pi^2}{27}$, (ii) $\int_0^1 \frac{1-x}{1+x^3} \log \frac{1}{x} dx = \frac{2\pi^2}{27}$,

(iii) $\int_0^1 \frac{1-x}{1+x^3} \left(\log \frac{1}{x}\right)^{2n-1} dx = \frac{(2^{2n-1}-1)(3^{2n}-1)}{2n \cdot 3^{2n}} \pi^{2n} B_{2n-1}$,

(iv) $\int_0^1 \frac{1-x}{1+x^3} \left(\log \frac{1}{x}\right)^{2n} dx = (2n)! \left(1 - \frac{1}{3^{2n+1}}\right) \left(1 - \frac{1}{2^{2n}}\right) S_{2n+1}$.

3. Prove that $\int_0^1 \frac{1+x+x^2+x^3}{1-x^6} \left(\log \frac{1}{x}\right)^3 dx = \frac{208}{3125} \pi^4$.

4. Show that $\int_0^1 \frac{1+x+x^2+x^3}{1-x^5} \left(\log \frac{1}{x}\right)^{2n-1} dx = \frac{1}{4n} \left(1 - \frac{1}{5^{2n}}\right) (2\pi)^{2n} B_{2n-1}$.

5. Show that

$$\int_0^1 \frac{1-x^{p-1}}{(1-x)(1-x^p)} \left(\log \frac{1}{x}\right)^{2n-1} dx = \frac{1}{4n} \left(1 - \frac{1}{p^{2n}}\right) (2\pi)^{2n} B_{2n-1},$$

where p is any prime number.

6. Show that

$$\int_0^1 \frac{1+x^2+x^4+x^6}{1-x^8} \left(\log \frac{1}{x}\right)^{2n-1} dx = \frac{1}{4n} \left(1 - \frac{1}{2^{2n}} + \frac{1}{6^{2n}}\right) (2\pi)^{2n} B_{2n-1}.$$

1084. Limits 0 to ∞ .

So far in this chapter the limits have been from 0 to 1. In some of the cases considered the integrations might have been taken from 0 to ∞ ; e.g. in the examples of Group B,

1. $\int_0^{\infty} \frac{\log \frac{1}{x}}{1-x^2} dx = \left(\int_0^1 + \int_1^{\infty}\right) \frac{\log \frac{1}{x}}{1-x^2} dx$. In the second integral put $x = \frac{1}{y}$.

$$\int_1^{\infty} \frac{\log \frac{1}{x}}{1-x^2} dx = \int_1^0 \frac{\log y}{1-y^2} \left(-\frac{1}{y^2}\right) dy = \int_0^1 \frac{\log \frac{1}{x}}{1-x^2} dx;$$

$$\therefore \int_0^{\infty} \frac{\log \frac{1}{x}}{1-x^2} dx = 2 \int_0^1 \frac{\log \frac{1}{x}}{1-x^2} dx = 2 \cdot \frac{\pi^2}{8} = \frac{\pi^2}{4}.$$

$$2. \int_0^{\infty} \frac{\log \frac{1}{x}}{1+x^2} dx = \left(\int_0^1 + \int_1^{\infty} \right) \frac{\log \frac{1}{x}}{1+x^2} dx. \quad \text{The second integral is}$$

$$\int_1^{\infty} \frac{\log y}{1+y^2} \left(-\frac{1}{y^2} \right) dy = \int_0^1 \frac{\log y}{1+y^2} dy = - \int_0^1 \frac{\log \frac{1}{x}}{1+x^2} dx;$$

$$\therefore \int_0^{\infty} \frac{\log \frac{1}{x}}{1+x^2} dx = 0.$$

$$3. \int_0^{\infty} \frac{\left(\log \frac{1}{x} \right)^{2n-1}}{1+x^2} dx = \left(\int_0^1 + \int_1^{\infty} \right) \frac{\left(\log \frac{1}{x} \right)^{2n-1}}{1+x^2} dx = 2 \int_0^1 \frac{\left(\log \frac{1}{x} \right)^{2n-1}}{1+x^2} dx \\ = \frac{\pi^{2n} (2^{2n} - 1)}{2^n} B_{2n-1}.$$

$$4. \int_0^{\infty} \frac{\left(\log \frac{1}{x} \right)^{2n}}{1+x^2} dx = \left(\int_0^1 + \int_1^{\infty} \right) \frac{\left(\log \frac{1}{x} \right)^{2n}}{1+x^2} dx = 2 \int_0^1 \frac{\left(\log \frac{1}{x} \right)^{2n}}{1+x^2} dx \\ = \left(\frac{\pi}{2} \right)^{2n+1} E_{2n}, \text{ and so on for other cases.}$$

1085. GROUP G.

Integrals of the class

$$I = \int_0^{\infty} \left(\frac{\log x}{x-1} \right)^n dx, \quad \text{i.e.} \quad \int_0^z \frac{\left(\log \frac{1}{x} \right)^n}{(1-x)^n} dx, \quad n > 1,$$

form a group of some interest. (Cf. Group C, Art. 1080.)

We have $I = \left(\int_0^1 + \int_1^{\infty} \right) \left(\frac{\log x}{x-1} \right)^n dx$, and putting $x = \frac{1}{y}$ in the second of these,

$$\int_1^{\infty} \left(\frac{\log x}{x-1} \right)^n dx = \int_1^0 \left(\frac{-\log y}{y-1} \right)^n \left(-\frac{1}{y^2} \right) dy = \int_0^1 \left(\frac{\log y}{y-1} \right)^n y^{n-2} dy = \int_0^1 \left(\frac{\log x}{x-1} \right)^n x^{n-2} dx;$$

$$\therefore I = \int_0^1 \frac{1+x^{n-2}}{(x-1)^n} (\log x)^n dx; \text{ and putting } x = e^{-z},$$

$$I = \int_0^{\infty} z^n \{1 + e^{-(n-2)z}\} \left\{ e^{-z} + ne^{-2z} + \frac{n(n+1)}{1 \cdot 2} e^{-3z} + \dots \right\} dz,$$

the expansion being convergent as e^{-z} is < 1 for all values of z between 0 and ∞ ;

$$\therefore I = \Gamma(n+1) \left[\frac{1}{1^{n+1}} + \frac{n}{1} \frac{1}{2^{n+1}} + \frac{n(n+1)}{1 \cdot 2} \frac{1}{3^{n+1}} + \frac{n(n+1)(n+2)}{1 \cdot 2 \cdot 3} \frac{1}{4^{n+1}} + \dots \right. \\ \left. + \frac{1}{(n-1)^{n+1}} + \frac{n}{1} \frac{1}{n^{n+1}} + \frac{n(n+1)}{1 \cdot 2} \frac{1}{(n+1)^{n+1}} + \frac{n(n+1)(n+2)}{1 \cdot 2 \cdot 3} \frac{1}{(n+2)^{n+1}} + \dots \right] \\ = n \left[\frac{\Gamma(n)}{1} \frac{1}{1^n} + \frac{\Gamma(n+1)}{1 \cdot 2} \frac{1}{2^n} + \frac{\Gamma(n+2)}{1 \cdot 2 \cdot 3} \frac{1}{3^n} + \dots \right. \\ \left. + \frac{\Gamma(n-1)}{(n-1)^n} + \frac{\Gamma(n)}{1} \frac{1}{n^n} + \frac{\Gamma(n+1)}{1 \cdot 2} \frac{1}{(n+1)^n} + \frac{\Gamma(n+2)}{1 \cdot 2 \cdot 3} \frac{1}{(n+2)^n} + \dots \right].$$

And if n be integral,

$$\begin{aligned}
 I &= n \left[\frac{2 \cdot 3 \dots (n-1)}{1^n} + \frac{3 \cdot 4 \dots n}{2^n} + \frac{4 \cdot 5 \dots (n+1)}{3^n} + \dots \right. \\
 &\quad \left. + \frac{1 \cdot 2 \dots (n-2)}{(n-1)^n} + \frac{2 \cdot 3 \dots (n-1)}{n^n} + \frac{3 \cdot 4 \dots n}{(n+1)^n} + \dots \right] \\
 &= n \sum_{r=1}^{r=n} \frac{(r+1)(r+2) \dots (r+n-2)}{r^n} + n \sum_{r=n-1}^{r=\infty} \frac{(r-1)(r-2) \dots \{r-(n-2)\}}{r^n} \\
 &= n \sum_{r=1}^{r=\infty} \frac{(r+1)(r+2) \dots (r+n-2) + (r-1)(r-2) \dots (r-n-2)}{r^n}. \dots\dots (A)
 \end{aligned}$$

The case of this when n is even is given by Wolstenholme, [Prob. 1919].

If $S_p = \frac{1}{1^p} + \frac{1}{2^p} + \frac{1}{3^p} + \dots$ and P_p stand for the sum of the products p at a time of the first $n-2$ natural numbers, this result may obviously be written

$$\begin{aligned}
 I &= 2n(S_2 + P_2 S_4 + P_4 S_6 + P_6 S_8 + \dots), \\
 \text{i.e.} \quad &= 2n \left(\frac{\pi^2}{6} + P_2 \frac{\pi^4}{90} + P_4 \frac{\pi^6}{945} + P_6 \frac{\pi^8}{9450} + P_8 \frac{\pi^{10}}{93555} + \dots \right). \quad (\text{See Art. 879.})
 \end{aligned}$$

In the case when $n=1$,

$$\begin{aligned}
 \int_0^{\infty} \frac{\log x}{x-1} dx &= \left(\int_0^1 + \int_1^{\infty} \right) \frac{\log x}{x-1} dx \\
 &= \int_0^1 \frac{\log x}{x-1} dx - \int_1^{\infty} \frac{\log y}{y-1} \frac{dy}{y}, \quad \text{where } x = \frac{1}{y}, \\
 &= \int_0^1 \frac{\log x}{x-1} dx + \int_0^1 \frac{\log x}{x(x-1)} dx \\
 &= \int_0^1 \frac{\log x}{x-1} dx + \int_0^1 \left(\frac{1}{x-1} - \frac{1}{x} \right) \log x dx \\
 &= 2 \int_0^1 \frac{\log x}{x-1} dx - \frac{1}{2} [(\log x)^2]_0^1,
 \end{aligned}$$

of which the second portion is infinite.

The first part is finite, viz. $2 \cdot \frac{\pi^2}{6} = \frac{\pi^2}{3}$.

EXAMPLES.

$$\begin{aligned}
 1. \quad \int_0^{\infty} \frac{(\log x)^2}{x-1} dx &= \int_0^{\infty} x^2(2)(e^{-x} + 2e^{-2x} + 3e^{-3x} + \dots) dx \\
 &= 4 \left(\frac{1}{1^3} + \frac{2}{2^3} + \frac{3}{3^3} + \dots \right) = \frac{2\pi^2}{3}.
 \end{aligned}$$

2. Prove

$$\begin{aligned}
 \int_0^{\infty} \frac{(\log x)^3}{x-1} dx &= \pi^3, & \int_0^{\infty} \frac{(\log x)^4}{x-1} dx &= 8 \left(\frac{\pi^2}{6} + \frac{2\pi^4}{90} \right) = \frac{4}{3} \pi^2 + \frac{8}{45} \pi^4, \\
 \int_0^{\infty} \frac{(\log x)^5}{x-1} dx &= \frac{5\pi^2}{3} + \frac{11\pi^4}{9}, & \int_0^{\infty} \frac{(\log x)^6}{x-1} dx &= 2\pi^2 + \frac{14}{3} \pi^4 + \frac{32}{105} \pi^6,
 \end{aligned}$$

and so on. (Cf. Examples 1, 7, 9, Group E, Art. 1082.)

1086. **A General Principle.**

More generally, it is an obvious principle that if $F(x)$ be any function of x which remains unaltered upon changing x into its reciprocal $\frac{1}{x}$, i.e. if $F(x)$ be a symmetric function of x and $\frac{1}{x}$, then, provided $\frac{F(x)}{x}$ remains finite from $x=0$ to $x=\infty$ inclusive,

$$\int_0^{\infty} F(x) \frac{dx}{x} = 2 \int_0^1 F(x) \frac{dx}{x}.$$

For
$$\int_0^{\infty} F(x) \frac{dx}{x} = \left(\int_0^1 + \int_1^{\infty} \right) F(x) \frac{dx}{x};$$

and changing x to $\frac{1}{y}$ in the second integral,

$$\int_1^{\infty} F(x) \frac{dx}{x} = \int_1^0 F\left(\frac{1}{y}\right) (-1) \frac{dy}{y} = \int_0^1 F(y) \frac{dy}{y} = \int_0^1 F(x) \frac{dx}{x}.$$

Hence
$$\int_0^{\infty} F(x) \frac{dx}{x} = 2 \int_0^1 F(x) \frac{dx}{x}.$$

Similarly if $F\left(\frac{1}{x}\right) = -F(x)$,
$$\int_0^{\infty} F(x) \frac{dx}{x} = 0.$$

1087. Again, if the value of any definite integral of the above form, viz. $I \equiv \int_0^{\infty} F(x) \frac{dx}{x}$, has been found, $F(x)$ being a symmetric function of x and $\frac{1}{x}$, the value of $I' \equiv \int_0^{\infty} \frac{F(x)}{1+x^n} \frac{dx}{x}$ can be at once obtained, where n may have any value. For in this integral put $\frac{1}{y}$ for x .

Then
$$I' = \int_{\infty}^0 \frac{y^n F\left(\frac{1}{y}\right)}{1+y^n} (-1) \frac{dy}{y} = \int_0^{\infty} \frac{x^n F(x)}{1+x^n} \frac{dx}{x},$$

$$\therefore 2I' = \int_0^{\infty} \frac{F(x)}{1+x^n} \frac{dx}{x} + \int_0^{\infty} \frac{x^n F(x)}{1+x^n} \frac{dx}{x}$$

$$= \int_0^{\infty} \frac{1+x^n}{1+x^n} F(x) \frac{dx}{x} = \int_0^{\infty} F(x) \frac{dx}{x} = I.$$

Hence

$$I' = \frac{1}{2}I.$$

1088. Similarly, if $F(x)$ be a symmetric function of $\frac{x}{a}$ and $\frac{a}{x}$, so that

$$F(x) = F\left(a \cdot \frac{x}{a}\right) = F\left(a \cdot \frac{a}{x}\right) = F\left(\frac{a^2}{x}\right),$$

then putting $x = \frac{a^2}{y}$,

$$I \equiv \int_0^\infty \frac{F(x)}{a^n + x^n} \frac{dx}{x} = \int_\infty^0 \frac{F\left(\frac{a^2}{y}\right)}{a^n + \frac{a^{2n}}{y^n}} (-1) \frac{dy}{y}$$

$$= \frac{1}{a^n} \int_0^\infty \frac{y^n F(y)}{a^n + y^n} \frac{dy}{y} = \frac{1}{a^n} \int_0^\infty \frac{x^n F(x)}{a^n + x^n} \frac{dx}{x};$$

$$\therefore 2I = \int_0^\infty \frac{1 + \frac{x^n}{a^n}}{a^n + x^n} F(x) \frac{dx}{x} = \frac{1}{a^n} \int_0^\infty F(x) \frac{dx}{x},$$

i.e.
$$\int_0^\infty \frac{F(x)}{a^n + x^n} \frac{dx}{x} = \frac{1}{2a^n} \int_0^\infty F(x) \frac{dx}{x}.$$

1089. Again, if $F(x)$ be symmetric in $\frac{x}{a}$ and $\frac{a}{x}$, so that $F(x) = F\left(\frac{a^2}{x}\right)$,

$$I \equiv \int_1^a F(x^2) \frac{dx}{x} = \int_1^a F(x) \frac{dx}{x}.$$

For writing $x^2 = z$, we have

$$\int_1^a F(x^2) \frac{dx}{x} = \frac{1}{2} \int_1^{a^2} F(z) \frac{dz}{z} = \frac{1}{2} \left(\int_1^a + \int_a^{a^2} \right) F(z) \frac{dz}{z}.$$

Putting $z = \frac{a^2}{t}$ in the second,

$$\int_a^{a^2} F(z) \frac{dz}{z} = \int_a^1 F\left(\frac{a^2}{t}\right) (-1) \frac{dt}{t} = \int_1^a F(t) \frac{dt}{t} = \int_1^a F(z) \frac{dz}{z};$$

$$\therefore \int_1^{a^2} F(x^2) \frac{dx}{x} = \int_1^a F(z) \frac{dz}{z} = \int_1^a F(x) \frac{dx}{x}.$$

We note also that it is therefore proved that

$$\int_1^{a^2} F(x) \frac{dx}{x} = 2 \int_1^a F(x^2) \frac{dx}{x} = 2 \int_1^a F(x) \frac{dx}{x}.$$

Again, taking $\int_{a^2}^{a^3} F(x) \frac{dx}{x}$, if we put $x = \frac{a^2}{t}$, we have

$$\int_{a^2}^{a^3} F(x) \frac{dx}{x} = - \int_1^a F\left(\frac{a^2}{t}\right) \frac{dt}{t} = - \int_1^a F(t) \frac{dt}{t};$$

$$\therefore \int_{a^2}^{a^3} F(x) \frac{dx}{x} = \int_1^a F(x) \frac{dx}{x}, \text{ with other similar results.}$$

1090. Since $\int_0^{\infty} \frac{1}{x + \frac{1}{x}} dx = \int_0^{\infty} \frac{dx}{1+x^2} = \frac{\pi}{2}$, it follows that

$$\int_0^{\infty} \frac{dx}{(1+x^2)(1+x^n)} = \int_0^{\infty} \frac{1}{(r+x^{-1})(1+x^n)} \frac{dx}{x} = \frac{1}{2} \int_0^{\infty} \frac{1}{r+x^{-1}} \frac{dx}{x} = \frac{\pi}{4}.$$

Similarly, since

$$\int_0^{\infty} \frac{1}{\frac{a^2}{x^2} + a^2} \frac{dx}{x} = \int_0^{\infty} \frac{a^2 r dr}{a^4 + r^4} = \frac{1}{2} \left[\tan^{-1} \frac{r^2}{a^2} \right]_0^{\infty} = \frac{\pi}{4},$$

we have $\int_0^{\infty} \frac{1}{a^n + x^n} \frac{1}{a^2 + x^2} \frac{dr}{x} = \frac{1}{2a^n} \frac{\pi}{4}$,

that is $\int_0^{\infty} \frac{x dr}{(a^4 + r^4)(a^n + x^n)} = \frac{\pi}{8} \frac{1}{a^{n+2}}$.

1091. It follows from Art. 1087, that since the expression $\frac{2x}{1+x^2}$ is unaltered by writing $\frac{1}{x}$ for x , writing $x = \tan \frac{\theta}{2}$,

$$\begin{aligned} I &\equiv \int_0^{\infty} \frac{F\left(\frac{2x}{1+x^2}\right)}{1+x^n} \frac{dx}{x} = \frac{1}{2} \int_0^{\frac{\pi}{2}} F\left(\frac{2r}{1+r^2}\right) \frac{dr}{x} \\ &= \int_0^{\frac{\pi}{2}} F\left(\frac{2r}{1+r^2}\right) \frac{dx}{x} = \int_0^{\frac{\pi}{2}} F(\sin \theta) \frac{d\theta}{\sin \theta}, \end{aligned}$$

a transformation given by Wolstenholme (*Educ. Times*, 9931).

We may also see the truth of this result by differentiation with regard to n , which gives

$$\begin{aligned} \frac{dI}{dn} &= - \int_0^{\infty} \frac{F\left(\frac{2r}{1+r^2}\right)}{(1+x^n)^2} x^n \log x \frac{dr}{x}, \text{ and writing } \frac{1}{x} \text{ for } x, \\ &= \int_0^{\infty} \frac{F\left(\frac{2r}{1+r^2}\right)}{(r^n+1)^2} r^n \log r \frac{dr}{r} = - \frac{dI}{dn}. \end{aligned}$$

$\therefore \frac{dI}{dn} = 0$, and I is therefore *independent* of n , and therefore the same as if $n=0$, i.e.

$$I \equiv \int_0^{\infty} \frac{F\left(\frac{2r}{1+r^2}\right)}{1+x^n} \frac{dr}{x} = \frac{1}{2} \int_0^{\frac{\pi}{2}} F\left(\frac{2r}{1+r^2}\right) \frac{dr}{r} = \text{etc.}$$

Putting $\frac{x}{a}$ for x , it follows that

$$\int_0^{\infty} \frac{F\left(\frac{2ax}{a^2+x^2}\right)}{a^n+x^n} \frac{dx}{x} = \frac{1}{a^n} \int_0^{\frac{\pi}{2}} F(\sin \theta) \frac{d\theta}{\sin \theta}.$$

1092. Thus, if $F(z)=z$, we have

$$\int_0^\infty \frac{dx}{(a^2+x^2)(a^n+x^n)} = \frac{1}{2a^{n+1}} \frac{\pi}{2} = \frac{\pi}{4a^{n+1}},$$

or if $F(z)=z^p$, p being a positive integer,

$$\begin{aligned} \int_0^\infty \frac{x^{p-1}}{(a^2+x^2)^p(a^n+x^n)} dx &= \frac{1}{2^p a^{p+n}} \int_0^{\frac{\pi}{2}} \sin^{p-1} \theta d\theta \\ &= \frac{1}{2^p} \frac{1}{a^{p+n}} \frac{p-2}{p-1} \frac{p-4}{p-3} \dots \frac{2}{3} \left(\text{or } \dots \frac{1}{2} \frac{\pi}{2} \right), \text{ as } p \text{ is even or odd.} \end{aligned}$$

1093. Consider next the value of $I_n \equiv \int_0^{\frac{\pi}{2}} (\log \tan \theta)^{2n} d\theta$, where n is any positive integer. Put $\tan \theta = x$.

$$\text{Then } I_n \equiv \int_0^\infty \frac{(\log x)^{2n}}{1+x^2} dx = \left(\int_0^1 + \int_1^\infty \right) \frac{(\log x)^{2n}}{1+x^2} dx.$$

In the second integral put $x = \frac{1}{y}$,

$$\int_1^\infty \frac{(\log x)^{2n}}{1+x^2} dx = \int_1^0 \frac{(-\log y)^{2n}}{1+\frac{1}{y^2}} \left(-\frac{1}{y^2}\right) dy = \int_0^1 \frac{(\log x)^{2n}}{1+x^2} dx;$$

$$\therefore I = 2 \int_0^1 \frac{(\log x)^{2n}}{1+x^2} dx;$$

$$\begin{aligned} \therefore I_n &= 2 \int_0^1 \frac{(-z)^{2n}}{1+e^{-2z}} (-e^{-1}) dz, \text{ where } x = e^{-1} \\ &= 2 \int_0^\infty z^{2n} (e^{-z} - e^{-3z} + e^{-5z} - e^{-7z} + \dots) dz \quad (0 < z < \infty) \\ &= 2\Gamma(2n+1) \left[\frac{1}{1^{2n+1}} - \frac{1}{3^{2n+1}} + \frac{1}{5^{2n+1}} - \dots \right] \\ &= 2\Gamma(2n+1) \frac{E_{2n} \left(\frac{\pi}{2}\right)^{2n+1}}{2(2n)!}, \text{ where } E_{2n} \text{ is the } n^{\text{th}} \text{ Eulerian number;} \\ \therefore \int_0^{\frac{\pi}{2}} (\log \tan \theta)^{2n} d\theta &= \left(\frac{\pi}{2}\right)^{2n+1} E_{2n}; \end{aligned}$$

and the values of E_{2n} being successively

$$E_2=1, \quad E_4=5, \quad E_6=61, \quad E_8=1385, \text{ etc. (see Art. 1073),}$$

we have

$$\begin{aligned} \int_0^{\frac{\pi}{2}} (\log \tan \theta)^2 d\theta &= \frac{\pi^3}{8}; & \int_0^{\frac{\pi}{2}} (\log \tan \theta)^4 d\theta &= \frac{5\pi^5}{32}; \\ \int_0^{\frac{\pi}{2}} (\log \tan \theta)^6 d\theta &= \frac{61\pi^7}{128}; & \int_0^{\frac{\pi}{2}} (\log \tan \theta)^8 d\theta &= \frac{1385\pi^9}{512}, \text{ etc.} \end{aligned}$$

1094. Since E_{2n} = coef. of $\frac{z^{2n}}{(2n)!}$ in the expansion of $\sec z$, i.e. $\left[\frac{d^{2n} \sec z}{dz^{2n}} \right]_{z=0}$,

$$\text{we have } \int_0^{\frac{\pi}{2}} (\log \tan \theta)^{2n} d\theta = \left(\frac{\pi}{2}\right)^{2n+1} \left[\frac{d^{2n} \sec z}{dz^{2n}} \right]_{z=0} \quad [\text{Wolstenholme}].$$

1095. The integral $I \equiv \int_0^{\frac{\pi}{2}} (\log \tan \theta)^{2n+1} d\theta$ vanishes.

For putting $\theta = \frac{\pi}{2} - \phi$, $I = -I$; $\therefore I = 0$.

Hence $\int_0^{\frac{\pi}{2}} (\log \tan \theta)^p d\theta = \left(\frac{\pi}{2}\right)^{p+1} E_p$ or 0, according as p is even or odd.

Also $\log \cot \theta = -\log \tan \theta$;

$\therefore \int_0^{\frac{\pi}{2}} (\log \cot \theta)^p d\theta = \left(\frac{\pi}{2}\right)^{p+1} E_p$ or 0, according as p is even or odd.

Hence $\int_0^{\frac{\pi}{2}} (\log \tan \theta)^p d\theta$ and $\int_0^{\frac{\pi}{2}} (\log \cot \theta)^p d\theta$ have been computed for all positive integral values of p .

1096. Let $I_1 \equiv \int_0^{\frac{\pi}{2}} (\log \sin \theta)^2 d\theta = \int_0^{\frac{\pi}{2}} (\log \cos \theta)^2 d\theta$,

and $I_2 \equiv \int_0^{\frac{\pi}{2}} (\log \sin \theta) (\log \cos \theta) d\theta$.

Then

$$\begin{aligned} 2I_1 + 2I_2 &= \int_0^{\frac{\pi}{2}} (\log \sin \theta + \log \cos \theta)^2 d\theta = \int_0^{\frac{\pi}{2}} (\log \sin 2\theta - \log 2)^2 d\theta \\ &= \int_0^{\frac{\pi}{2}} (\log \sin 2\theta)^2 d\theta - 2 \log 2 \int_0^{\frac{\pi}{2}} \log \sin 2\theta d\theta + (\log 2)^2 \int_0^{\frac{\pi}{2}} 1 d\theta. \end{aligned}$$

Writing $2\theta = \phi$,

$$\int_0^{\frac{\pi}{2}} (\log \sin 2\theta)^2 d\theta = \frac{1}{2} \int_0^{\pi} (\log \sin \phi)^2 d\phi = \int_0^{\frac{\pi}{2}} (\log \sin \theta)^2 d\theta = I_1,$$

and $\int_0^{\frac{\pi}{2}} \log \sin 2\theta d\theta = \frac{1}{2} \int_0^{\pi} \log \sin \phi d\phi = \int_0^{\frac{\pi}{2}} \log \sin \phi d\phi = \frac{\pi}{2} \log \frac{1}{2}$;

$$\therefore 2I_1 + 2I_2 = I_1 - 2 \log 2 \cdot \frac{\pi}{2} \log \frac{1}{2} + (\log 2)^2 \frac{\pi}{2},$$

i.e. $I_1 + 2I_2 = \frac{3\pi}{2} (\log 2)^2$ (A)

Again

$$2I_1 - 2I_2 = \int_0^{\frac{\pi}{2}} (\log \sin \theta - \log \cos \theta)^2 d\theta = \int_0^{\frac{\pi}{2}} (\log \tan \theta)^2 d\theta = \frac{\pi^3}{8}; \dots (B)$$

$$\left. \begin{aligned} I_1 + 2I_2 &= \frac{3\pi}{2} (\log 2)^2, \\ I_1 - I_2 &= \frac{\pi^3}{16}; \end{aligned} \right\}$$

$$\therefore \text{ solving, } \left. \begin{aligned} I_1 &= \int_0^{\frac{\pi}{2}} (\log \sin \theta)^2 d\theta = \int_0^{\frac{\pi}{2}} (\log \cos \theta)^2 d\theta = \frac{\pi}{2} (\log 2)^2 + \frac{\pi^3}{24}, \\ I_2 &= \int_0^{\frac{\pi}{2}} \log \sin \theta \cdot \log \cos \theta d\theta = \frac{\pi}{2} (\log 2)^2 - \frac{\pi^3}{48}. \end{aligned} \right\}$$

These results are due to the late Professor Wolstenholme.

Obviously it follows that

$$\int_0^{\frac{\pi}{2}} \log \sin \theta \cdot \log \cos \theta \, d\theta = \frac{1}{2} \int_0^{\frac{\pi}{2}} \log \sin \theta \log \cos \theta \, d\theta = \frac{\pi}{4} (\log 2)^2 - \frac{\pi^3}{96}.$$

1097. We may write the expression for cosec z in partial fractions (Hobson, *Trigonometry*, p. 335) as

$$\operatorname{cosec} z = \dots + \frac{1}{z-2\pi} - \frac{1}{z-\pi} + \frac{1}{z} - \frac{1}{z+\pi} + \frac{1}{z+2\pi} - \dots, \dots \dots (A)$$

it being understood that this doubly infinite series extends equal distances to infinity on either side of the central term $\frac{1}{z}$ marked with an asterisk.

A similar expression for cosec² z is

$$\operatorname{cosec}^2 z = \dots + \frac{1}{(z-2\pi)^2} + \frac{1}{(z-\pi)^2} + \frac{1}{z^2} + \frac{1}{(z+\pi)^2} + \frac{1}{(z+2\pi)^2} + \dots, \dots (B)$$

with the same understanding as before. [614, Wolstenholme's *Problems*.]

The latter is obtainable from a consideration of the factorisation of

$$\frac{\cosh x + \cos \theta}{2 \cos^2 \frac{\theta}{2}}, \quad \text{viz.} \quad \prod_{r=-\infty}^{r=\infty} \left\{ 1 + \frac{x^2}{(2r+1\pi + \theta)^2} \right\}$$

[viz. equating coefficients of x^2 in the expansion and writing $\pi - 2z$ for θ].

Differentiating these expressions respectively $2r+1$ times and $2r$ times, and then putting $z = \frac{\pi}{n}$ in each, we have

$$\begin{aligned} & \frac{1}{(2r+1)!} \left(\frac{\pi}{n} \right)^{2r+1} \left[\frac{d^{2r}}{dz^{2r}} \left(\frac{\cos z}{\sin^2 z} \right) \right]_{z=\frac{\pi}{n}} \\ &= \dots + \frac{1}{(2n-1)^{2r+1}} - \frac{1}{(n-1)^{2r+1}} + \frac{1}{1^{2r+1}} - \frac{1}{(n+1)^{2r+1}} + \frac{1}{(2n+1)^{2r+1}} - \dots, \quad (A') \end{aligned}$$

$$\begin{aligned} & \frac{1}{(2r+1)!} \left(\frac{\pi}{n} \right)^{2r+1} \left[\frac{d^{2r}}{dz^{2r}} \left(\frac{1}{\sin^2 z} \right) \right]_{z=\frac{\pi}{n}} \\ &= \dots + \frac{1}{(2n-1)^{2r+1}} + \frac{1}{(n-1)^{2r+1}} + \frac{1}{1^{2r+1}} + \frac{1}{(n+1)^{2r+1}} + \frac{1}{(2n+1)^{2r+1}} + \dots \dots (B') \end{aligned}$$

Now consider the integral

$$I = \int_0^{\infty} \frac{(\log x)^{2r+1}}{1+x^n} dx = \left(\int_0^1 + \int_1^{\infty} \right) \frac{(\log \frac{1}{x})^{2r+1}}{1+x^n} dx.$$

In the second integral write $x = \frac{1}{y}$.

Then

$$\int_1^{\infty} \frac{(\log x)^{2r+1}}{1+x^n} dx = \int_1^0 \frac{(\log y)^{2r+1}}{1+y^{-n}} \left(-\frac{1}{y^2} \right) dy = - \int_0^1 \frac{(\log \frac{1}{x})^{2r+1}}{1+x^n} x^{n-2} dx$$

$$\begin{aligned} \therefore I &= \int_0^1 \frac{1-x^{n-1}}{1+x^n} \left(\log \frac{1}{x}\right)^{2r+1} dx = \int_0^\infty y^{2r+1} \frac{e^{-y} - e^{-(n-1)y}}{1+e^{-ny}} dy, \text{ where } x=e^{-y}, \\ &= \int_0^\infty y^{2r+1} \{e^{-y} - e^{-(n-1)y}\} (1 - e^{-ny} + e^{-2ny} - e^{-3ny} + \dots) dy \\ &= \int_0^\infty y^{2r+1} \{ \dots + e^{-2n-1}y - e^{-n-1}y + e^{-y} - e^{-n+1}y + e^{-2n+1}y - \dots \} dy \\ &= (2r+1)! \left\{ \dots + \frac{1}{(2n-1)^{2r+1}} - \frac{1}{(n-1)^{2r+1}} + \frac{1}{1^{2r+1}} - \frac{1}{(n+1)^{2r+1}} + \frac{1}{(2n+1)^{2r+1}} - \dots \right\} \\ &= (2r+1)! \cdot \frac{1}{(2r+1)!} \left(\frac{\pi}{n}\right)^{2r+1} \left[\frac{d^{2r}}{dz^{2r}} \left(\frac{\cos z}{\sin^2 z} \right) \right]_{z=\frac{\pi}{n}} = \left(\frac{\pi}{n}\right)^{2r+1} \left[\frac{d^{2r}}{dz^{2r}} \left(\frac{\cos z}{\sin^2 z} \right) \right]_{z=\frac{\pi}{n}}. \end{aligned}$$

1098. Again, if

$$I' = \int_0^\infty \frac{\left\{ \log \frac{1}{x} \right\}^{2r+1}}{1-x^n} dx = \left[\int_0^1 + \int_1^\infty \right] \frac{\left(\log \frac{1}{x} \right)^{2r+1}}{1-x^n} dx,$$

putting $x = \frac{1}{y}$ in the second integral,

$$\begin{aligned} I' &= \int_0^1 \frac{\left(\log \frac{1}{x}\right)^{2r+1}}{1-x^n} dx + \int_1^\infty x^{n-2} \frac{\left(\log \frac{1}{x}\right)^{2r+1}}{1-x^n} dx \\ &= \int_0^1 \frac{1+x^{n-2}}{1-x^n} \left(\log \frac{1}{x}\right)^{2r+1} dx = \int_0^\infty \frac{e^{-y} + e^{-(n-1)y}}{1-e^{-ny}} y^{2r+1} dy, \text{ where } x=e^{-y}, \\ &= \int_0^\infty y^{2r+1} \{e^{-y} + e^{-(n-1)y}\} (1 + e^{-ny} + e^{-2ny} + \dots) dy \\ &= \int_0^\infty y^{2r+1} \{ \dots + e^{-2n-1}y + e^{-n-1}y + e^{-y} + e^{-n+1}y + e^{-2n+1}y + \dots \} dy \\ &= (2r+1)! \left\{ \dots + \frac{1}{(2n-1)^{2r+1}} + \frac{1}{(n-1)^{2r+1}} + \frac{1}{1^{2r+1}} + \frac{1}{(n+1)^{2r+1}} + \frac{1}{(2n+1)^{2r+1}} + \dots \right\} \\ &= (2r+1)! \cdot \frac{1}{(2r+1)!} \left(\frac{\pi}{n}\right)^{2r+1} \left[\frac{d^{2r}}{dz^{2r}} \left(\frac{1}{\sin^2 z} \right) \right]_{z=\frac{\pi}{n}} = \left(\frac{\pi}{n}\right)^{2r+1} \left[\frac{d^{2r}}{dz^{2r}} \left(\frac{1}{\sin^2 z} \right) \right]_{z=\frac{\pi}{n}}. \end{aligned}$$

$$\text{Thus } \left. \begin{aligned} \int_0^\infty \frac{\left(\log \frac{1}{x}\right)^{2r+1}}{1+x^n} dx &= \left(\frac{\pi}{n}\right)^{2r+1} \left[\frac{d^{2r}}{dz^{2r}} \left(\frac{\cos z}{\sin^2 z} \right) \right]_{z=\frac{\pi}{n}}, \\ \int_0^\infty \frac{\left(\log \frac{1}{x}\right)^{2r+1}}{1-x^n} dx &= \left(\frac{\pi}{n}\right)^{2r+1} \left[\frac{d^{2r}}{dz^{2r}} \left(\frac{1}{\sin^2 z} \right) \right]_{z=\frac{\pi}{n}}, \end{aligned} \right\} \text{ provided } n > 1.$$

These results are due to Wolstenholme.*

1099. GROUP H. Legendre's Rule.

$$I_p \equiv \int_0^1 \left(\frac{x^m - 1}{\log x} \right)^p x^{n-1} dx. \quad (\text{Euler.})$$

Integrating the result $\int_0^1 x^n dx = \frac{1}{n+1}$ with regard to n between limits 0 and n , we obtain

$$\int_0^1 \frac{x^n - 1}{\log x} dx = \log(1+n). \dots \dots \dots (1)$$

* Problems, 1919, 41 and 42.

Hence

$$\int_0^1 \frac{x^m - x^n}{\log x} dx = \int_0^1 \frac{(x^m - 1) - (x^n - 1)}{\log x} dx = \log \frac{1+m}{1+n} \dots\dots\dots(2)$$

and $\int_0^1 \frac{x^m - 1}{\log x} \cdot x^{n-1} dx = \int_0^1 \frac{(x^{m+n-1} - 1) - (x^{n-1} - 1)}{\log x} dx = \log \left(1 + \frac{m}{n}\right) \dots(3)$

If $F(x)$ be any polynomial in which the sum of the coefficients is zero,

$$\begin{aligned} &= A_0 x^n + A_1 x^{n-1} + A_2 x^{n-2} + \dots + A_{n-1} x + A_n, \quad \sum_0^n A_r = 0, \\ &= A_0(x^n - 1) + A_1(x^{n-1} - 1) \dots + A_{n-1}(x - 1) \end{aligned}$$

Then

$$\begin{aligned} \int_0^1 \frac{F(x)}{\log x} dx &= A_0 \log(n+1) + A_1 \log n + A_2 \log(n-1) + \dots + A_{n-1} \log 2 \\ &= \log(n+1)^{A_0} n^{A_1} (n-1)^{A_2} \dots 2^{A_{n-1}} \dots \dots\dots(4) \end{aligned}$$

Let Δ be an operative symbol defined by

$$\Delta r_n = r_{n+m} - r_n.$$

Then equation (3) may be written

$$I_1 = \Delta \log n. \dots\dots\dots(5)$$

Taking $I_2 = \int_0^1 \left(\frac{x^m - 1}{\log x}\right)^2 x^{n-1} dx,$

$$\frac{dI_2}{dm} = 2 \int_0^1 \frac{x^m - 1}{\log x} x^{m+n-1} dx = 2[\log(2m+n) - \log(m+n)].$$

Integrating with regard to m from 0 to $m,$

$$\begin{aligned} I_2 &= 2 \left[\frac{2m+n}{2} \log(2m+n) - \frac{2m+n}{2} \right]_0^m - 2 \left[(m+n) \log(m+n) - (m+n) \right]_0^m \\ &= (2m+n) \log(2m+n) - 2(m+n) \log(m+n) + n \log n = \Delta^2 n \log n. \dots(6) \end{aligned}$$

Similarly $I_3 = \frac{1}{2!} \Delta^3 n^2 \log n, \quad I_4 = \frac{1}{3!} \Delta^4 n^3 \log n, \text{ etc.} \dots\dots\dots(7)$

Some of these integrals were established by Euler (*Calc. Int.*, iv., p. 271). The general rule was given by Legendre (*Exercises*, p. 372).

1100. Kummer's Integrals. (Crelle, T. xvii., p. 224.)

From equation (2) of the last article,

(i) $I = \int_0^1 \frac{x^a - x^b}{1+x^c} \cdot \frac{1}{\log x} \cdot \frac{dx}{x} = \int_0^1 (x^{a-1} - x^{b-1})(1 - x^c + x^{2c} - \dots) \frac{dx}{\log x}$
 $= \log \frac{a}{b} - \log \frac{a+c}{b+c} + \log \frac{a+2c}{b+2c} - \dots = \log \left(\frac{a}{b} \cdot \frac{b+c}{a+c} \cdot \frac{a+2c}{b+2c} \cdot \frac{b+3c}{a+3c} \dots \right);$

(ii) $I' = \int_0^1 \frac{x^a - x^b}{1-x^c} \cdot \frac{1}{\log x} \cdot \frac{dx}{x} = \log \left(\frac{a}{b} \cdot \frac{a+c}{b+c} \cdot \frac{a+2c}{b+2c} \cdot \frac{a+3c}{b+3c} \dots \right)$

in the same way.

Putting $c=1$ and $a+b=1$ in (i),

$$\begin{aligned} & \int_0^1 \frac{x^a - x^{1-a}}{1+x} \cdot \frac{1}{\log x} \cdot \frac{dx}{x} \\ &= \int_0^1 \frac{x^{a-1} - x^{-a}}{1+x} \cdot \frac{dx}{\log x} = \log \left(\frac{a}{1-a} \cdot \frac{2-a}{1+a} \cdot \frac{2+a}{3-a} \cdot \frac{4-a}{3+a} \dots \right) \\ &= Lt_{n \rightarrow \infty} \left\{ a \frac{1-\frac{a^2}{2^2}}{1-\frac{a^2}{1^2}} \cdot \frac{1-\frac{a^2}{4^2}}{1-\frac{a^2}{3^2}} \dots \frac{1-\frac{a^2}{(2n)^2}}{1-\frac{a^2}{(2n-1)^2}} \cdot \frac{1}{1-\frac{a}{2n+1}} \times \frac{2^2 \cdot 4^2 \dots (2n)^2}{1^2 \cdot 3^2 \dots (2n-1)^2} \cdot \frac{1}{2n+1} \right\} \\ &= \log \left(\frac{2}{\pi} \tan \frac{\pi a}{2} \times \frac{\pi}{2} \right) = \log \tan \frac{\pi a}{2}. \end{aligned}$$

EXAMPLES.

1. Deduce the integral $\int_0^{\frac{\pi}{2}} \log \sin \theta \, d\theta = \frac{\pi}{2} \log \frac{1}{2}$ from the theorem

$$\frac{x^{2n}-1}{x^2-1} = \left(x^2 - 2x \cos \frac{\pi}{n} + 1 \right) \left(x^2 - 2x \cos \frac{2\pi}{n} + 1 \right) \dots \left\{ x^2 - 2x \cos \frac{(n-1)\pi}{n} + 1 \right\}.$$

[LESLIE ELLIS, *Cam. Math. Jour.*, vol. vii., p. 282.]

2. Show that $\int_0^{\frac{\pi}{2}} \sin \theta \log \sin \theta \, d\theta = \log_e \left(\frac{2}{e} \right)$.

3. Show that $\int_0^{\frac{\pi}{2}} \sin^2 \theta \log \sin \theta \, d\theta = \frac{\pi}{8} \log_e \left(\frac{e}{4} \right)$.

[EULER, *Nov. Com. Petrop.*, vol. xix., p. 30.]

4. Prove that $\int_0^1 \frac{\log(1+x)}{1+x^2} dx = \frac{\pi}{8} \log_e 2$. [COLLEGES β , 1890]

5. Prove that $\int_0^{\frac{\pi}{4}} \log(1+\tan \theta) d\theta = \frac{\pi}{8} \log_e 2$. [TRINITY, 1885.]

6. Prove that $\int_0^{\frac{\pi}{2}} \tan \theta \log \operatorname{cosec} \theta \, d\theta = \frac{\pi^2}{24}$. [TRINITY, 1884.]

7. Prove that $\int_0^{\frac{\pi}{2}} \sin 2\theta \log(1+\cos \theta) d\theta = \frac{1}{2}$. [TRINITY, 1885.]

8. Prove that if a be < 1 , $\int_0^1 \log \frac{1+ax}{1-ax} \cdot \frac{dx}{x\sqrt{1-x^2}} = \pi \sin^{-1} a$. [OXFORD, II. P., 1888.]

9. Prove that $\int_0^1 \left(\frac{\log x}{1-x} \right)^2 dx = 2 \int_0^1 \left(\frac{\log x}{1+x} \right)^2 dx = \frac{\pi^2}{3}$. [ST. JOHN'S, 1881.]

10. Prove that

$$\int_0^{\frac{\pi}{2}} \sin x \log \left(\frac{1+\sin a \sin x}{1-\sin a \sin x} \right) dx = \int_0^a \sin x \tan^{-1}(\tan a \sin x) dx = \pi \tan \frac{a}{2}.$$

[ST. JOHN'S, 1881.]

11. Show that $\int_0^1 \frac{(\log x)^2}{1+x^2} dx = \frac{1}{2} \int_0^\infty \frac{(\log x)^2}{1+x^2} dx = \frac{\pi^3}{16}$.
12. Prove that $\int_1^\infty \frac{1}{x} \log(1-x) dx = \frac{\pi^2}{6}$. [OXFORD, I. P., 1889.]
13. Prove that $\int_0^\infty \frac{\left(\log \frac{1}{x}\right)^3}{(1+x)^4} dx = \frac{\pi^2}{2}$. [COLLEGES δ , 1883.]
14. Prove that $\int_0^\infty \frac{\log \frac{1}{x}}{(1+x)^4} dx = \frac{1}{2}$. [COLLEGES γ , 1882.]
15. Prove that $\int_0^1 \log \frac{1+2r \cos \alpha + x^2}{1-2r \cos \alpha + x^2} \frac{dx}{x} = \pi \left(\frac{\pi}{2} - \alpha\right)$ where $\pi > \alpha > 0$. [COLLEGES γ , 1882.]
16. Prove that $\int_0^1 \log x \log(1-x) dx = 2 - \frac{\pi^2}{6}$. [ST. JOHN'S, 1885.]
17. Show that $\int_0^\infty f\left(x + \frac{1}{x}\right) \log x \frac{dx}{x} = 0$. [COLLEGES δ , 1881.]
18. Show that $\int_0^{\frac{\pi}{2}} \frac{\log \sec r}{\sin r} dr = \frac{\pi^2}{8}$. [COLLEGES ϵ , 1881.]
19. Show that $\int_0^{\frac{\pi}{2}} \log \frac{1 + \cos^2 \theta}{\sqrt{1 + \frac{1}{2} \cos^2 \theta}} d\theta = \frac{\pi}{4} \log 2$. [R.P.]
20. Show that $\int_0^{\frac{\pi}{2}} \tan \theta \sec 2\theta \log \cot \theta d\theta = \frac{\pi^2}{24}$. [ST. JOHN'S, 1882.]

1101. GROUP I. Derivations from

$$\int_0^\infty \frac{x^{a-1}}{1+x} dx = \int_0^1 \frac{x^{a-1} + x^{-a}}{1+x} dx = \pi \operatorname{cosec} a\pi, \quad (1 > a > 0), \text{ Art. 871. } \dots(1)$$

Put $x = y^n$, $a = \frac{p}{n}$. Then

$$\int_0^\infty \frac{y^{p-1}}{1+y^n} dy = \int_0^1 \frac{y^{p-1} + y^{n-p-1}}{1+y^n} dy = \frac{\pi}{n} \operatorname{cosec} \frac{p\pi}{n}, \quad (n > p > 0). \dots(2)$$

The case $n = 2$ gives

$$\int_0^\infty \frac{x^{p-1}}{1+x^2} dx = \int_0^1 \frac{x^{p-1} + x^{1-p}}{1+x^2} dx = \frac{\pi}{2} \operatorname{cosec} \frac{p\pi}{2}, \quad (2 > p > 0). \dots(3)$$

Putting $p = m + 1$, we have

$$\int_0^\infty \frac{x^m}{1+x^2} dx = \int_0^1 \frac{x^m + x^{-m}}{1+x^2} dx = \frac{\pi}{2} \sec \frac{m\pi}{2}, \quad (1 > m > -1). \dots(4)$$

Put $p = 1$ in (2),

$$\int_0^\infty \frac{dx}{1+x^n} = \int_0^1 \frac{1+x^{n-2}}{1+x^n} dx = \frac{\pi}{n} \operatorname{cosec} \frac{\pi}{n}, \quad (n > 1). \dots\dots\dots(5)$$

Put $y = \frac{x}{\sqrt[n]{1-x^n}}$ in (2),

$$\int_0^1 \frac{x^{p-1}}{(1-x^n)^p} dx = \frac{\pi}{n} \operatorname{cosec} \frac{p\pi}{n}, \quad (n > p > 0). \quad \dots(6)$$

Put $p=1$ in (6),

$$\int_0^1 \frac{dx}{\sqrt[n]{1-x^n}} = \frac{\pi}{n} \operatorname{cosec} \frac{\pi}{n}, \quad (n > 1). \quad \dots\dots\dots(7)$$

From (4), $\int_0^1 \frac{x^m + x^{-m}}{x + x^{-1}} \frac{dx}{x} = \frac{\pi}{2} \sec \frac{m\pi}{2}, \quad (1 > m > -1).$

This may be written as

$$\int_0^1 \frac{\cosh(m \log x)}{\cosh^2(\log x)} \frac{dx}{x} = \frac{\pi}{2} \sec \frac{m\pi}{2}, \quad (1 > m > -1). \quad (8)$$

Put $x = e^{-z}$, q positive; $mq = p$, and replace z by x ,

$$\int_0^\infty \frac{\cosh px}{\cosh qx} dx = \frac{\pi}{2q} \sec \frac{p\pi}{2q}, \quad (q > p > -q). \quad (9)$$

Put $q = \pi$, $\int_0^\infty \frac{\cosh px}{\cosh \pi x} dx = \frac{1}{2} \sec \frac{p}{2}, \quad (\pi > p > -\pi). \quad (10)$

Put $x = \frac{y}{b}$ in (1),

$$\int_0^\infty \frac{y^{a-1}}{b+y} dy = \pi b^{a-1} \operatorname{cosec} a\pi, \quad (1 > a > 0). \quad (11)$$

Diff. $r-1$ times with respect to b ,

$$\int_0^\infty \frac{y^{a-1}}{(b+y)^r} dy = \frac{(1-a)(2-a)\dots(r-1-a)}{1 \cdot 2 \dots (r-1)} \pi b^{a-r} \operatorname{cosec} a\pi, \quad (1 > a > 0). \quad (12)$$

Integrate (11) with regard to b from b_1 to b_2 ,

$$\int_0^\infty y^{a-1} \log \frac{b_2+y}{b_1+y} dy = \pi \frac{b_2^a - b_1^a}{a} \operatorname{cosec} a\pi, \quad (1 > a > 0). \quad \dots(13)$$

Write $x = by$ in (1),

$$\int_0^\infty \frac{y^{a-1}}{1+by} dy = \pi b^{-a} \operatorname{cosec} a\pi, \quad (1 > a > 0). \quad \dots(14)$$

Diff. $r-1$ times with respect to b ,

$$\int_0^\infty \frac{y^{a+r-2}}{(1+by)^r} dy = \pi \frac{\alpha(\alpha+1)\dots(\alpha+r-2)}{1 \cdot 2 \dots (r-1)} b^{-\alpha-r+1} \operatorname{cosec} \alpha\pi, \quad (1 > \alpha > 0). \quad (15)$$

Diff. (10) with regard to p ,

$$\int_0^\infty x \frac{\sinh px}{\cosh \pi x} dx = \frac{1}{4} \sec \frac{p}{2} \tan \frac{p}{2}, \quad (\pi > p > -\pi). \quad (16)$$

Integrate (10) with regard to p between 0 and p ,

$$\int_0^\infty \frac{\sinh px}{\cosh \pi x} \frac{dx}{x} = \log \tan \frac{\pi+p}{4}, \quad (\pi > p > -\pi). \quad (17)$$

Diff. (1) with regard to a ,

$$\int_0^\infty \frac{x^a \log x}{1+x} \frac{dx}{x} = -\pi^2 \operatorname{cosec} a\pi \cot a\pi, \quad (1 > a > 0), \quad \dots(18)$$

etc. Thus obviously a large number of such results may be derived.

1102. GROUP J.

Next consider the **similar integral** $\int_0^{\infty} \frac{x^{a-1}}{1-x} dx$ ($1 > a > 0$).

Here the integrand $\frac{x^{a-1}}{1-x}$ has infinities at $x=0$ and at $x=1$.

At $x=0$, since a is positive and < 1 , the limit of $\int_0^{\epsilon_1} \frac{x^{a-1}}{1-x} dx$, when ϵ_1 is indefinitely diminished, is zero (Art. 348). We have to examine the behaviour of the integral in the neighbourhood of $x=1$. Consider the integral

$$\left(\int_0^{1-\epsilon} + \int_{1+\eta}^{\infty} \right) \frac{x^{a-1}}{1-x} dx \quad (1 > a > 0),$$

where ϵ and η are small positive and arbitrary quantities.

In the second integral put $x = \frac{1}{y}$.

Then

$$\begin{aligned} \int_{1+\eta}^{\infty} \frac{x^{a-1}}{1-x} dx &= \int_{\frac{1}{1+\eta}}^0 \frac{y^{1-a}}{1-y^{-1}} (-y^{-2}) dy = - \int_0^{\frac{1}{1+\eta}} \frac{x^{-a}}{1-x} dx \\ &= - \left(\int_0^{1-\epsilon} + \int_{1-\epsilon}^{\frac{1}{1+\eta}} \right) \frac{x^{-a}}{1-x} dx. \end{aligned}$$

And in the second of these let $x = 1 - \xi$.

$$\begin{aligned} \int_{1-\epsilon}^{\frac{1}{1+\eta}} \frac{x^{-a}}{1-x} dx &= - \int_{\epsilon}^{\frac{\eta}{\xi}} \frac{(1-\xi)^{-a}}{\xi} d\xi \\ &= - \int_{\epsilon}^{\frac{\eta}{\xi}} \left(\frac{1}{\xi} + a + \frac{a(a+1)}{1.2} \xi + \dots \right) d\xi, \end{aligned}$$

a convergent series, since $\xi < 1$,

$$= - \log \frac{\eta}{\epsilon(1+\eta)} - a \left(\frac{\eta}{1+\eta} - \epsilon \right) - \dots;$$

and if η and ϵ are made ultimately zero *in a ratio of equality*, the limit of this portion is zero, otherwise it is of arbitrary value.

Hence we shall take $\eta = \epsilon$, and then

$$\left(\int_0^{1-\epsilon} + \int_{1+\eta}^{\infty} \right) \frac{x^{a-1}}{1-x} dx$$

is in the limit the same as

$$\int_0^{1-\epsilon} \frac{x^{a-1}}{1-x} dx, - \int_0^{1-\epsilon} \frac{x^{-a}}{1-x} dx,$$

i.e. the Principal Value of

$$\int_0^{\infty} \frac{x^{a-1}}{1-x} dx \text{ is } Lt_{\epsilon=0} \int_0^{1-\epsilon} \frac{x^{a-1}-x^{-a}}{1-x} dx,$$

the General Value being an arbitrary quantity depending upon the relative mode of approach of ϵ and η to their limits.

Now in $\int_0^1 \frac{x^{a-1}-x^{-a}}{1-x} dx$, the limit of $\frac{x^{a-1}-x^{-a}}{1-x}$, when x is unity, is $-(2a-1)$, and is therefore finite, so that the last element of the integral when expressed as a summation from $x=0$ to $x=1$, contributes nothing.

$$\begin{aligned} \text{Therefore } Lt_{\epsilon=0} \int_0^{1-\epsilon} \frac{x^{a-1}-x^{-a}}{1-x} dx &= \int_0^1 \frac{x^{a-1}-x^{-a}}{1-x} dx \\ &= \int_0^1 (x^{a-1}-x^{-a}) \left(1+x+x^2+x^3+\dots+x^n+\frac{x^{n+1}}{1-x} \right) dx \\ &= \left\{ \frac{1}{a} - \frac{1}{1+a} + \frac{1}{2+a} - \frac{1}{3+a} + \dots + \frac{1}{n+a} \right\} - \frac{1}{n-a+1} + \int_0^1 x^{n+1} \frac{x^{a-1}-x^{-a}}{1-x} dx. \end{aligned}$$

Now in the limit when n is infinite, the portion in the brackets is ultimately equal to $\pi \cot a\pi$.

The limit of the term $\frac{1}{n-a+1}$ is zero; and in the integral the subject of integration is ultimately zero for all values of $x < 1$, i.e.

$$Lt_{n=\infty} \int_0^{1-\epsilon} x^{n+1} \frac{x^{a-1}-x^{-a}}{1-x} dx = 0.$$

And for the remaining part of the integral

$$\int_0^1 x^{n+1} \frac{x^{a-1}-x^{-a}}{1-x} dx, \text{ viz. } \int_{1-\epsilon}^1 x^{n-1} \frac{x^{a-1}-x^{-a}}{1-x} dx,$$

we may remark that, the integrand being finite, if we take P and Q as its greatest and least values in the region between $1-\epsilon$ and 1, this integral lies between

$$P \int_{1-\epsilon}^1 1 \cdot dx \text{ and } Q \int_{1-\epsilon}^1 1 \cdot dx,$$

i.e. between $P\epsilon$ and $Q\epsilon$, and therefore vanishes in the limit.

Hence, summing up, the Principal Value of the integral

$$\int_0^{\infty} \frac{x^{a-1}}{1-x} dx \quad \text{is} \quad \int_0^1 \frac{x^{a-1}-x^{-a}}{1-x} dx,$$

and is equal to $\pi \cot a\pi \quad (1 > a > 0)$(1)

1103. In the derived results which follow we shall regard all the integrals which occur as Principal Values.

Starting with Prin. Val. of

$$\int_0^{\infty} \frac{x^{a-1}}{1-x} dx = \int_0^1 \frac{x^{a-1}-x^{-a}}{1-x} dx = \pi \cot a\pi, \quad (1 > a > 0), \quad \dots\dots(1)$$

we proceed as in Art. 1101.

Put $x = y^n, a = \frac{p}{n}$. Then

$$\int_0^{\infty} \frac{y^{p-1}}{1-y^n} dy = \int_0^1 \frac{y^{p-1}-y^{n-p-1}}{1-y^n} dy = \frac{\pi}{n} \cot \frac{p\pi}{n}, \quad (n > p > 0). \dots\dots(2)$$

The case $n = 2$ gives

$$\int_0^{\infty} \frac{x^{p-1}}{1-x^2} dx = \int_0^1 \frac{x^{p-1}-x^{1-p}}{1-x^2} dx = \frac{\pi}{2} \cot \frac{p\pi}{2}, \quad (2 > p > 0). \dots\dots(3)$$

Putting $p = m + 1$, we have

$$\int_0^{\infty} \frac{x^m}{1-x^2} dx = \int_0^1 \frac{x^{m-1}-x^{-m-1}}{1-x^2} dx = -\frac{\pi}{2} \tan \frac{m\pi}{2}, \quad (1 > m > -1). \dots\dots(4)$$

Put $p = 1$ in (2),

$$\int_0^{\infty} \frac{dx}{1-x^n} = \int_0^1 \frac{1-x^{n-2}}{1-x^n} dx = \frac{\pi}{n} \cot \frac{\pi}{n}, \quad (n > 1), \quad \dots\dots(5)$$

From (4), $\int_0^1 \frac{x^m-x^{-m}}{x-x^{-1}} \frac{dx}{x} = \frac{\pi}{2} \tan \frac{m\pi}{2}, \quad (1 > m > -1). \dots\dots(6)$

This may be written as

$$\int_0^1 \frac{\sinh(m \log x)}{\sinh(\log x)} \frac{dx}{x} = \frac{\pi}{2} \tan \frac{m\pi}{2}, \quad (1 > m > -1). \dots\dots(7)$$

Put $x = e^{-z}, q$ positive ; $m q = p$, and replace z by x ,

$$\int_0^{\infty} \frac{\sinh px}{\sinh qx} dx = \frac{\pi}{2q} \tan \frac{p\pi}{2q}, \quad (q > p > -q). \dots\dots(8)$$

Put $q = \pi, \int_0^{\infty} \frac{\sinh px}{\sinh \pi x} dx = \frac{1}{2} \tan \frac{p}{2}, \quad (\pi > p > -\pi). \dots(9)$

Differentiate with regard to p ,

$$\int_0^{\infty} x \frac{\cosh px}{\sinh \pi x} dx = \frac{1}{4} \sec^2 \frac{p}{2}, \quad (\pi > p > -\pi). \dots(10)$$

Integrate (9) with regard to p from 0 to 1,

$$\int_0^{\infty} \frac{\sinh^2 \frac{px}{2}}{\sinh \pi x} \frac{dx}{x} = \frac{1}{2} \log \sec \frac{p}{2}, \quad (\pi > p > -\pi), \dots(11)$$

or between b and a ,

$$\int_0^\infty \frac{\cosh ax - \cosh bx}{\sinh \pi x} \frac{dx}{x} = \log \left(\frac{\cos \frac{b}{2}}{\cos \frac{a}{2}} \right), \quad (\pi > a > b > -\pi), \quad (12)$$

and it is as before obvious that many further deductions may be made.

1104. **Lemma.** We shall require the factorisation of $\cos u\pi + \cosh v\pi$.

$$\begin{aligned} \cos u\pi + \cosh v\pi &= \cos u\pi + \cos iv\pi = 2 \cos \frac{u+iv}{2} \pi \cos \frac{u-iv}{2} \pi \\ &= 2 \prod_0^\infty \left(1 - \frac{(u+iv)^2}{(2r+1)^2} \right) \left(1 - \frac{(u-iv)^2}{(2r+1)^2} \right) \\ &= 2 \prod_0^\infty [(2r+1+u)^2 + v^2][(2r+1-u)^2 + v^2]/(2r+1)^4. \end{aligned}$$

Logarithmic differentiation with regard to u and v gives

$$(1) \frac{-\pi \sin u\pi}{\cos u\pi + \cosh v\pi} = 2 \sum_0^\infty \left(\frac{2r+1+u}{2r+1+|u|^2+v^2} - \frac{2r+1-u}{2r+1-|u|^2+v^2} \right),$$

$$(2) \frac{\pi \sinh v\pi}{\cos u\pi + \cosh v\pi} = 2v \sum_0^\infty \left(\frac{1}{2r+1+|u|^2+v^2} + \frac{1}{2r+1-|u|^2+v^2} \right).$$

1105. **GROUP K.**

Type $I \equiv \int_0^\infty \frac{\cosh px}{\sinh qx} \sin mx \, dx$, etc. (q positive, $p^2 \neq q^2$).

Here $I = \int_0^\infty (e^{px} + e^{-px})(e^{-qx} + e^{-3qx} + e^{-5qx} + \dots) \sin mx \, dx$, the integrand being finite for all positive values of x and the series convergent ;

$$\begin{aligned} \therefore I &= \int_0^\infty \sum_0^\infty [e^{-\{(2r+1)q+p\}x} + e^{-\{(2r+1)q-p\}x}] \sin mx \, dx \\ &= \sum_0^\infty \left[\frac{m}{\{(2r+1)q+p\}^2 + m^2} + \frac{m}{\{(2r+1)q-p\}^2 + m^2} \right] \\ &= \frac{\pi}{2q} \frac{\sinh \frac{m\pi}{q}}{\cos \frac{p\pi}{q} + \cosh \frac{m\pi}{q}}, \text{ by the Lemma, } \dots\dots\dots (A) \end{aligned}$$

q being positive and p intermediate between q and $-q$, inclusive.

Similarly

$$\begin{aligned} \int_0^\infty \frac{\sinh px}{\sinh qx} \cos mx \, dx &= \int_0^\infty (e^{px} - e^{-px})(e^{-qx} + e^{-3qx} + \dots) \cos mx \, dx \\ &= \int_0^\infty \sum_0^\infty [e^{-\{(2r+1)q-p\}x} - e^{-\{(2r+1)q+p\}x}] \cos mx \, dx \\ &= \sum_0^\infty \left[\frac{(2r+1)q-p}{\{(2r+1)q-p\}^2 + m^2} - \frac{(2r+1)q+p}{\{(2r+1)q+p\}^2 + m^2} \right] \\ &= \frac{\pi}{2q} \frac{\sin \frac{p\pi}{q}}{\cos \frac{p\pi}{q} + \cosh \frac{m\pi}{q}} \dots\dots\dots (B) \end{aligned}$$

Writing $2x$ for x in (A) and $p + \frac{q}{2}$, $p - \frac{q}{2}$ in succession for p , and subtracting,

$$\int_0^{\infty} \frac{\cosh(2p+q)x - \cosh(2p-q)x}{2 \sinh qx \cosh qx} \sin 2mx \, dx$$

$$= \frac{\pi}{4q} \left(\frac{\sinh \frac{m\pi}{q}}{-\sin \frac{p\pi}{q} + \cosh \frac{m\pi}{2}} - \frac{\sinh \frac{m\pi}{q}}{\sin \frac{p\pi}{q} + \cosh \frac{m\pi}{q}} \right),$$

$$\therefore \int_0^{\infty} \frac{\sinh 2px}{\cosh qx} \sin 2mx \, dx = \frac{\pi}{2q} \frac{\sin \frac{p\pi}{q} \sinh \frac{m\pi}{q}}{\cosh^2 \frac{m\pi}{q} - \sin^2 \frac{p\pi}{q}}$$

$$= \frac{\pi}{q} \frac{\sin \frac{p\pi}{q} \sinh \frac{m\pi}{q}}{\cos \frac{2p\pi}{q} + \cosh \frac{2m\pi}{q}} \quad (p^2 \neq q^2);$$

and replacing $2p$ and $2m$ by p and m ,

$$\int_0^{\infty} \frac{\sinh px}{\cosh qx} \sin mx \, dx = \frac{\pi}{q} \frac{\sin \frac{p\pi}{2q} \sinh \frac{m\pi}{2q}}{\cos \frac{p\pi}{q} + \cosh \frac{m\pi}{q}} \quad (q \text{ positive, } p^2 \neq q^2). \dots (C)$$

Treating (B) in the same way,

$$\int_0^{\infty} \frac{\sinh(2p+q)x - \sinh(2p-q)x}{2 \sinh qx \cosh qx} \cos 2mx \, dx$$

$$= \frac{\pi}{4q} \left(\frac{\cos \frac{p\pi}{q}}{-\sin \frac{p\pi}{q} + \cosh \frac{m\pi}{q}} - \frac{-\cos \frac{p\pi}{q}}{\sin \frac{p\pi}{q} + \cosh \frac{m\pi}{q}} \right),$$

$$\int_0^{\infty} \frac{\cosh 2px}{\cosh qx} \cos 2mx \, dx = \frac{\pi}{2q} \frac{\cos \frac{p\pi}{q} \cosh \frac{m\pi}{q}}{\cosh^2 \frac{m\pi}{q} - \sin^2 \frac{p\pi}{q}}$$

$$= \frac{\pi}{q} \frac{\cos \frac{p\pi}{q} \cosh \frac{m\pi}{q}}{\cos \frac{2p\pi}{q} + \cosh \frac{2m\pi}{q}} \quad (p^2 \neq q^2);$$

and replacing $2p$ and $2m$ by p and m ,

$$\int_0^{\infty} \frac{\cosh px}{\cosh qx} \cos mx \, dx = \frac{\pi}{q} \frac{\cos \frac{p\pi}{2q} \cosh \frac{m\pi}{2q}}{\cos \frac{p\pi}{q} + \cosh \frac{m\pi}{q}} \quad (q \text{ positive, } p^2 \neq q^2). \dots (D)$$

We thus have ($p^2 \neq q^2$)

$$\int_0^\infty \frac{\cosh px}{\sinh qx} \sin mx \, dx = \frac{\pi}{2q} \frac{\sinh \frac{m\pi}{q}}{\cos \frac{p\pi}{q} + \cosh \frac{m\pi}{q}}, \dots\dots\dots(A)$$

$$\int_0^\infty \frac{\sinh px}{\sinh qx} \cos mx \, dx = \frac{\pi}{2q} \frac{\sin \frac{p\pi}{q}}{\cos \frac{p\pi}{q} + \cosh \frac{m\pi}{q}}, \dots\dots\dots(B)$$

$$\int_0^\infty \frac{\sinh px}{\cosh qx} \sin mx \, dx = \frac{\pi}{q} \frac{\sin \frac{p\pi}{2q} \sinh \frac{m\pi}{2q}}{\cos \frac{p\pi}{q} + \cosh \frac{m\pi}{q}}, \dots\dots\dots(C)$$

$$\int_0^\infty \frac{\cosh px}{\cosh qx} \cos mx \, dx = \frac{\pi}{q} \frac{\cos \frac{p\pi}{2q} \cosh \frac{m\pi}{2q}}{\cos \frac{p\pi}{q} + \cosh \frac{m\pi}{q}}, \dots\dots\dots(D)$$

1106. **Special Cases.**

(i) Put $q = \pi$, then ($p^2 \neq \pi^2$),

$$\int_0^\infty \frac{\cosh px}{\sinh \pi x} \sin mx \, dx = \frac{1}{2} \frac{\sinh m}{\cos p + \cosh m}, \quad \int_0^\infty \frac{\sinh px}{\cosh \pi x} \sin mx \, dx = \frac{\sin \frac{p}{2} \sinh \frac{m}{2}}{\cos p + \cosh m},$$

$$\int_0^\infty \frac{\sinh px}{\sinh \pi x} \cos mx \, dx = \frac{1}{2} \frac{\sin p}{\cos p + \cosh m}, \quad \int_0^\infty \frac{\cosh px}{\cosh \pi x} \cos mx \, dx = \frac{\cos \frac{p}{2} \cosh \frac{m}{2}}{\cos p + \cosh m}.$$

(ii) Put $q = \frac{\pi}{2}$, then ($4p^2 \neq \pi^2$)

$$\int_0^\infty \frac{\cosh px}{\sinh \frac{\pi x}{2}} \sin mx \, dx = \frac{\sinh 2m}{\cos 2p + \cosh 2m}, \quad \int_0^\infty \frac{\sinh px}{\cosh \frac{\pi x}{2}} \sin mx \, dx = 2 \frac{\sin p \sinh m}{\cos 2p + \cosh 2m},$$

$$\int_0^\infty \frac{\sinh px}{\sinh \frac{\pi x}{2}} \cos mx \, dx = \frac{\sin 2p}{\cos 2p + \cosh 2m}, \quad \int_0^\infty \frac{\cosh px}{\cosh \frac{\pi x}{2}} \cos mx \, dx = 2 \frac{\cos p \cosh m}{\cos 2p + \cosh 2m}.$$

(iii) Put $p = 0$ in (A) and (D),

$$\int_0^\infty \frac{\sin mx}{\sinh qx} \, dx = \frac{\pi}{2q} \tanh \frac{m\pi}{2q}, \quad \int_0^\infty \frac{\cos mx}{\cosh qx} \, dx = \frac{\pi}{2q} \operatorname{sech} \frac{m\pi}{2q}.$$

(iv) Putting $q = \pi$ in these results,

$$\int_0^\infty \frac{\sin mx}{\sinh \pi x} \, dx = \frac{1}{2} \tanh \frac{m}{2}, \quad \int_0^\infty \frac{\cos mx}{\cosh \pi x} \, dx = \frac{1}{2} \operatorname{sech} \frac{m}{2}.$$

(v) Putting $m = 0$ in (B) and (D) ($p^2 \neq q^2$),

$$\int_0^\infty \frac{\sinh px}{\sinh qx} \, dx = \frac{\pi}{2q} \tan \frac{p\pi}{2q}, \quad \int_0^\infty \frac{\cosh px}{\cosh qx} \, dx = \frac{\pi}{2q} \sec \frac{p\pi}{2q}.$$

(vi) Putting $q = \pi$ in these results ($p^2 \neq \pi^2$),

$$\int_0^\infty \frac{\sinh px}{\sinh \pi x} \, dx = \frac{1}{2} \tan \frac{p}{2}, \quad \int_0^\infty \frac{\cosh px}{\cosh \pi x} \, dx = \frac{1}{2} \sec \frac{p}{2}.$$

(vii) Putting $q = \frac{\pi}{2}$ in (v) ($4p^2 \neq \pi^2$),

$$\int_0^{\infty} \frac{\sinh px}{\sinh \frac{\pi x}{2}} dx = \tan p, \quad \int_0^{\infty} \frac{\cosh px}{\cosh \frac{\pi x}{2}} dx = \sec p.$$

(viii) Putting $p = q$ in (A) and (C),

$$\int_0^{\infty} \coth qx \sin mx dx = \frac{\pi}{2q} \coth \frac{m\pi}{2q}, \quad \int_0^{\infty} \tanh qx \sin mx dx = \frac{\pi}{2q} \operatorname{cosech} \frac{m\pi}{2q}.$$

(ix) Putting $q = \pi$ in the latter,

$$\int_0^{\infty} \coth \pi x \sin mx dx = \frac{1}{2} \coth \frac{m}{2}, \quad \int_0^{\infty} \tanh \pi x \sin mx dx = \frac{1}{2} \operatorname{cosech} \frac{m}{2}.$$

1167. Other Modes of Derivation.

Besides such integrals as those indicated, which are merely particular cases of one or other of the four formulae *A, B, C, D*, many definite integrals may be obtained by differentiation or integration, between specified limits, with regard to one or other of the constants p, q or m .

EXAMPLES.

1. Taking $\int_0^{\infty} \frac{\sin mx}{\sinh \pi x} dx = \frac{1}{2} \tanh \frac{m}{2}$, write $2m$ for m and integrate with regard to m from 0 to m . Then

$$\int_0^{\infty} \operatorname{cosech} \pi x \left[-\frac{\cos 2mx}{2x} \right]_0^m dx = \frac{1}{2} \log \cosh m,$$

that is $\int_0^{\infty} \operatorname{cosech} \pi x \sin^2 mx \frac{dx}{x} = \frac{1}{2} \log \cosh m.$

2. Deduce from $\int_0^{\infty} \frac{\cos mx}{\cosh \pi x} dx = \frac{1}{2} \operatorname{sech} \frac{m}{2}$,

$$(a) \int_0^{\infty} x \frac{\sin mx}{\cosh \pi x} dx = \frac{1}{4} \tanh \frac{m}{2} \operatorname{sech} \frac{m}{2}, \quad (b) \int_0^{\infty} \frac{\sin mx}{\cosh \pi x} \frac{dx}{x} = \tan^{-1} \left(\sinh \frac{m}{2} \right).$$

3. Deduce from $\int_0^{\infty} \frac{\cosh px}{\sinh \pi x} \sin mx dx = \frac{1}{2} \frac{\sinh m}{\cos p + \cosh m}$,

$$(a) \int_0^{\infty} \operatorname{cosech} \pi x \cosh px \sin^2 \frac{mx}{2} \frac{dx}{x} = \frac{1}{4} \log \left(\frac{\cos p + \cosh m}{1 + \cos p} \right),$$

$$(b) \int_0^{\infty} x \frac{\sinh px}{\sinh \pi x} \sin mx dx = \frac{1}{2} \frac{\sinh m \sin p}{(\cos p + \cosh m)^2},$$

$$(c) \int_0^{\infty} x \frac{\cosh px}{\sinh \pi x} \cos mx dx = \frac{1}{2} \frac{1 + \cos p \cosh m}{(\cos p + \cosh m)^2}.$$

$$4. \text{ Deduce from } \int_0^{\infty} \frac{\sinh px}{\sinh \pi x} \cos mx \, dx = \frac{1}{2} \frac{\sin p}{\cos p + \cosh m},$$

$$\int_0^{\infty} \frac{\sinh px}{\sinh \pi x} \sin mx \, dx = \tan^{-1} \left(\tanh \frac{m}{2} \tan \frac{p}{2} \right).$$

And it will be obvious that a large number of such results may be obtained. The results of putting $m=0$ will in many cases lead to integrals obtained in a different manner earlier.

1108. GROUP L. Poisson's Formulae.

Let $f(x)$ be a function of x such that Taylor's Theorem gives convergent expansions for $f(a+u)$ and $f(a+u^{-1})$, where $u=e^{\theta}$. Then expanding

$$f(a+u) + f(a+u^{-1})$$

$$= 2 \left[f(a) + f'(a) \cos \theta + \frac{1}{2!} f''(a) \cos 2\theta + \frac{1}{3!} f'''(a) \cos 3\theta + \dots \right].$$

Multiplying by

$$\frac{1-c^2}{1-2c \cos \theta + c^2} = 1 + 2c \cos \theta + 2c^2 \cos 2\theta + \dots, \quad \text{if } c^2 < 1,$$

or by

$$\frac{c^2-1}{1-2c \cos \theta + c^2} = 1 + 2c^{-1} \cos \theta + 2c^{-2} \cos 2\theta + \dots, \quad \text{if } c^2 > 1,$$

and integrating between 0 and π , we have

$$\int_0^{\pi} \frac{f(a+u) + f(a+u^{-1})}{1-2c \cos \theta + c^2} d\theta = \frac{2\pi}{1-c^2} \left\{ f(a) + cf'(a) + \frac{c^2}{2!} f''(a) + \dots \right\}$$

$$= \frac{2\pi}{1-c^2} f(a+c), \quad \text{if } c^2 < 1,$$

$$\text{or } = \frac{2\pi}{c^2-1} \left\{ f(a) + c^{-1}f'(a) + \frac{c^{-2}}{2!} f''(a) + \dots \right\}$$

$$= \frac{2\pi}{c^2-1} f(a+c^{-1}), \quad \text{if } c^2 > 1.$$

EXAMPLES.

1. Show that, u standing for e^{θ} ,

$$\int_0^{\pi} \sin \theta \frac{f(a+u) - f(a+u^{-1})}{1-2c \cos \theta + c^2} d\theta = \frac{i\pi}{c} \{f(a+c) - f(a)\} \quad (\text{if } c^2 < 1)$$

$$\text{or } = \frac{i\pi}{c} \{f(a+c^{-1}) - f(a)\} \quad (\text{if } c^2 > 1).$$

2. Show that

$$\int_0^{\pi} \frac{1-c \cos \theta}{1-2c \cos \theta + c^2} \{f(a+u) + f(a+u^{-1})\} d\theta = \pi \{f(a) + f(a+c)\} \quad (c^2 < 1)$$

$$\text{or } = \pi \{f(a) - f(a+c^{-1})\} \quad (c^2 > 1).$$

3. Show that

$$\int_0^\pi \frac{\sin \theta}{(1-2c \cos \theta + c^2)^2} \{f(a+u) - f(a+u^{-1})\} d\theta = \frac{\pi c}{1-c^2} f'(a+c) \quad (c^2 < 1).$$

4. Taking $f(x) = x^n$, show that

$$\int_0^\pi \frac{(1+2a \cos \theta + a^2)^{\frac{n}{2}}}{1-2c \cos \theta + c^2} \cos \left(n \tan^{-1} \frac{\sin \theta}{a + \cos \theta} \right) d\theta = \frac{\pi}{1-c^2} (a+c)^n \quad (c^2 < 1).$$

5. Show that

$$\begin{aligned} \int_0^\pi \frac{\sin \theta}{1-2c \cos \theta + c^2} (1+2a \cos \theta + a^2)^{\frac{n}{2}} \sin \left(n \tan^{-1} \frac{\sin \theta}{a + \cos \theta} \right) d\theta \\ = \frac{\pi}{2c} \{(a+c)^n - a^n\} \quad (c^2 < 1). \end{aligned}$$

6. Show that

$$\begin{aligned} \int_0^\pi \frac{\sin \theta}{(1-2c \cos \theta + c^2)^2} (1+2a \cos \theta + a^2)^{\frac{n}{2}} \sin \left(n \tan^{-1} \frac{\sin \theta}{a + \cos \theta} \right) d\theta \\ = \frac{\pi}{2(1-c^2)} n(a+c)^{n-1} \quad (c^2 < 1). \end{aligned}$$

7. Deduce known results from 4, 5, 6 by putting $n=1$.

8. Prove
$$\int_0^\pi \frac{e^{k \cos x} \cos(k \sin x)}{1-2c \cos x + c^2} dx = \frac{\pi}{1-c^2} e^{kc} \quad (c^2 < 1).$$

1109. GROUP M. **Abel's Formula.** (See Bertrand, *Calc. Int.*, p. 171.)

Supposing $F(c+a)$ capable of expansion in a series of powers of e^{-a} in the form $A_0 + A_1 e^{-a} + A_2 e^{-2a} + \dots$, whether a be real or imaginary, then putting $i\beta t$ for a , we have

$$A_0 + A_1 \cos \beta t + A_2 \cos 2\beta t + \dots = \frac{1}{2} \{F(c+i\beta t) + F(c-i\beta t)\}.$$

It follows that

$$\begin{aligned} \int_0^\infty \frac{F(c+i\beta t) + F(c-i\beta t)}{b^2 + t^2} dt \\ = 2 \int_0^\infty \left(\frac{A_0}{b^2 + t^2} + \frac{A_1 \cos \beta t}{b^2 + t^2} + \frac{A_2 \cos 2\beta t}{b^2 + t^2} + \dots \right) dt \\ = \frac{\pi}{b} \{A_0 + A_1 e^{-b\beta} + A_2 e^{-2b\beta} + \dots\} \\ = \frac{\pi}{b} F(c+b\beta). \end{aligned}$$

In Abel's Formula b is taken as unity.

EXAMPLES.

1. Taking $F(z) = z^{-n}$,

$$F(c + i\beta t) + F(c - i\beta t) = (c^2 + \beta^2 t^2)^{-\frac{n}{2}} 2 \cos \left(n \tan^{-1} \frac{\beta t}{c} \right);$$

$$\therefore \int_0^{\infty} \frac{\cos \left(n \tan^{-1} \frac{\beta t}{c} \right)}{(c^2 + \beta^2 t^2)^{\frac{n}{2}}} \frac{dt}{b^2 + t^2} = \frac{\pi}{2b} (c + b\beta)^{-n}.$$

2. Deduce the formulae

$$(a) \int_0^x \frac{dt}{(c^2 + a^2 t^2)(b^2 + t^2)} = \frac{\pi}{2bc} \frac{1}{c + ab},$$

$$(b) \int_0^{\frac{\pi}{2}} \frac{\cos n\phi \cos^n \phi d\phi}{a^2 \cos^2 \phi + c^2 \sin^2 \phi} = \frac{\pi}{2a} \frac{c^{n-1}}{(c+a)^n}. \quad [\text{BERTRAND.}]$$

3. Show that $\int_0^{\infty} \frac{e^{c \cos(at)} \cos(c \sin(at))}{b^2 + t^2} dt = \frac{\pi}{2b} e^{c^2 - ba}$.

1110. GROUP N. A Set mainly due to CAUCHY.

The integrand of $\int_0^{\infty} \frac{dx}{a^2 - x^2}$ ($a > 0$) has infinities at a and at $-a$. The latter lies outside the range of integration.

Now

$$\begin{aligned} \int_0^{a-\epsilon} \frac{dx}{a^2 - x^2} + \int_{a+\eta}^{\infty} \frac{dx}{a^2 - x^2} &= \frac{1}{2a} \left[\log \frac{a+x}{a-x} \right]_0^{a-\epsilon} + \frac{1}{2a} \left[\log \frac{x+a}{x-a} \right]_{a+\eta}^{\infty} \\ &= \frac{1}{2a} \log \frac{2a-\epsilon}{\epsilon} - \frac{1}{2a} \log \frac{2a+\eta}{\eta} = \frac{1}{2a} \log \frac{\eta}{\epsilon} \cdot \frac{2a-\epsilon}{2a+\eta}. \end{aligned}$$

If η, ϵ be made to vanish in a ratio of equality, this vanishes; \therefore the Principal Value of $\int_0^{\infty} \frac{dx}{a^2 - x^2}$ is zero.

1111. Consider next the Principal Values of

$$I_1 \equiv \int_0^{\infty} \frac{dx}{(a^2 - x^2)(x^2 + p^2)}, \quad I_2 \equiv \int_0^{\infty} \frac{x^2 dx}{(a^2 - x^2)(x^2 + p^2)}.$$

$$I_1 \equiv \frac{1}{a^2 + p^2} \int_0^{\infty} \frac{dx}{a^2 - x^2} + \frac{1}{a^2 + p^2} \int_0^{\infty} \frac{dx}{x^2 + p^2} = 0 + \frac{1}{a^2 + p^2} \cdot \frac{\pi}{2p} = \frac{\pi}{2p} \frac{1}{a^2 + p^2},$$

$$I_2 \equiv \frac{a^2}{a^2 + p^2} \int_0^{\infty} \frac{dx}{a^2 - x^2} - \frac{p^2}{a^2 + p^2} \int_0^{\infty} \frac{dx}{x^2 + p^2} = 0 - \frac{p^2}{a^2 + p^2} \cdot \frac{\pi}{2p} = -\frac{\pi}{2} \frac{p}{a^2 + p^2}.$$

If then $\phi(x)$ be such a function as can be expressed in partial fractions of the form $\phi(x) = \Sigma \frac{A}{a^2 - x^2}$, we have as Principal Values,

$$I_1' \equiv \int_0^\infty \frac{\phi(x)}{p^2+x^2} dx = \frac{\pi}{2p} \sum \frac{A}{a^2+p^2} = \frac{\pi}{2p} \phi(p\sqrt{-1}),$$

$$I_2' \equiv \int_0^\infty \frac{x^2 \phi(x)}{p^2+x^2} dx = -\frac{\pi}{2p} \sum \frac{Ap^2}{a^2+p^2} = \frac{\pi}{2p} F(p\sqrt{-1}),$$

where $F(x) = x^2 \phi(x)$, provided $Lt_{x=\infty} \frac{x^2 \phi(x)}{p^2+x^2}$ be finite.

[The results obtained in the following articles to 1118 are all Principal Values of the several integrals discussed.]

1112. Thus, for instance, since we have

$$\frac{\tan ax}{x} = 8a \sum_1^\infty \frac{1}{(2r-1)^2 \pi^2 - 4a^2 x^2}, \quad \sec ax = 4 \sum_1^\infty \frac{(-1)^{r-1} (2r-1) \pi}{(2r-1)^2 \pi^2 - 4a^2 x^2},$$

$$x \cot ax = \frac{1}{a} + 2 \sum_1^\infty \frac{ax^2}{a^2 x^2 - r^2 \pi^2}, \quad x \operatorname{cosec} ax = \frac{1}{a} + \sum_1^\infty \frac{(-1)^r 2ax^2}{a^2 x^2 - r^2 \pi^2},$$

it follows that, considering Principal Values,

$$\left. \begin{aligned} \text{(i)} \quad \int_0^\infty \frac{\tan ax}{x} \frac{dx}{p^2+x^2} &= \frac{\pi}{2p} \frac{\tan ap}{ap} = \frac{\pi}{2p^2} \tanh ap, \\ \text{(ii)} \quad \int_0^\infty \sec ax \frac{dx}{p^2+x^2} &= \frac{\pi}{2p} \sec ap = \frac{\pi}{2p} \operatorname{sech} ap, \\ \text{(iii)} \quad \int_0^\infty x \cot ax \frac{dx}{p^2+x^2} &= \frac{\pi}{2p} ap \cot ap = \frac{\pi}{2} \coth ap, \\ \text{(iv)} \quad \int_0^\infty x \operatorname{cosec} ax \frac{dx}{p^2+x^2} &= \frac{\pi}{2p} ap \operatorname{cosec} ap = \frac{\pi}{2} \operatorname{cosech} ap. \end{aligned} \right\} \dots\dots (A)$$

1113. Again, it is clear from the expressions for $\sin \theta$ and $\cos \theta$ in factors, that the fractions ($a < b$)

$$\frac{\sin ax}{\sin bx}, \quad \frac{\cos ax}{\cos bx}, \quad \frac{\sin ax}{x \cos bx}, \quad \frac{x \sin ax}{\cos bx}, \quad \frac{x \cos ax}{\sin bx},$$

are expressible as the sums of an infinite number of partial fractions with pure quadratic denominators (*e.g.* see Ex. 52, p. 169), and therefore, when $a < b$, we have immediately

$$\begin{aligned} \text{(i)} \quad \int_0^\infty \frac{\sin ax}{\sin bx} \frac{dx}{p^2+x^2} &= \frac{\pi}{2p} \frac{\sinh ap}{\sinh bp}, & \text{(ii)} \quad \int_0^\infty \frac{\cos ax}{\cos bx} \frac{dx}{p^2+x^2} &= \frac{\pi}{2p} \frac{\cosh ap}{\cosh bp}, \\ \text{(iii)} \quad \int_0^\infty \frac{\sin ax}{\cos bx} \frac{dx}{x(p^2+x^2)} &= \frac{\pi}{2p^2} \frac{\sinh ap}{\cosh bp}, & \text{(iv)} \quad \int_0^\infty \frac{\sin ax}{\cos bx} \frac{x dx}{p^2+x^2} &= -\frac{\pi}{2} \frac{\sinh ap}{\cosh bp}, \\ \text{(v)} \quad \int_0^\infty \frac{\cos ax}{\sin bx} \frac{x dx}{p^2+x^2} &= \frac{\pi}{2} \frac{\cosh ap}{\sinh bp}. \end{aligned} \dots\dots\dots (B)$$

1114. In the limit when $a=0$, we have cases (i), (iii), (iv) giving a zero result, but from (ii) and (v),

$$\int_0^{\infty} \frac{\sec bx}{p^2+x^2} dx = \frac{\pi}{2p} \operatorname{sech} bp \quad \text{and} \quad \int_0^{\infty} \frac{x \operatorname{cosec} bx}{p^2+x^2} dx = \frac{\pi}{2} \operatorname{cosech} bp. \dots (C)$$

Also in the case when $a=b$, we have,

$$\left. \begin{aligned} \text{(i) and (ii) become } \int_0^{\infty} \frac{dx}{p^2+x^2} &= \frac{\pi}{2p}, \\ \text{(iii) } \int_0^{\infty} \frac{\tan bx dx}{x(p^2+x^2)} &= \frac{\pi}{2p^2} \tanh bp \quad (\text{from A (i)}), \\ \text{(iv) } \int_0^{\infty} \frac{x \tan bx}{p^2+x^2} dx &= \int_0^{\infty} \left\{ \frac{\tan bx}{x} - \frac{p^2 \tan bx}{x(p^2+x^2)} \right\} dx = \frac{\pi}{2} - \frac{\pi}{2} \tanh bp \\ &\quad (\text{see Art. 1007}), \\ \text{(v) } \int_0^{\infty} \frac{x \cot bx}{p^2+x^2} dx &= \frac{\pi}{2} \coth bp \quad (\text{from A (iii)}). \end{aligned} \right\} (D)$$

1115. The cases in which $a > b$ can readily be obtained by means of the following identities. Let $a = 2rb + c$, where r is an integer and c is positive or negative, but numerically less than b .

$$\begin{aligned} (1) \quad & 2\{\cos(a-b)x + \cos(a-3b)x + \dots + \cos(a-\overline{2r-1}b)x\} = \frac{\sin ax}{\sin bx} - \frac{\sin cx}{\sin bx}, \\ (2) \quad & 2\{\cos(a-b)x - \cos(a-3b)x + \dots + (-1)^{r-1} \cos(a-\overline{2r-1}b)x\} = \frac{\cos ax}{\cos bx} - (-1)^r \frac{\cos cx}{\cos bx}, \\ (3) \quad & 2\{\sin(a-b)x - \sin(a-3b)x + \dots + (-1)^{r-1} \sin(a-\overline{2r-1}b)x\} = \frac{\sin ax}{\sin bx} - (-1)^r \frac{\sin cx}{\sin bx}, \\ (4) \quad & 2\{\sin(a-b)x + \sin(a-3b)x + \dots + \sin(a-\overline{2r-1}b)x\} = \frac{\cos cx}{\sin bx} - \frac{\cos ax}{\sin bx}. \end{aligned}$$

$$\begin{aligned} \text{Now} \quad \int_0^{\infty} \frac{\cos rx}{p^2+x^2} dx &= \frac{\pi}{2p} e^{-pr}, & \int_0^{\infty} \frac{x \sin rx}{p^2+x^2} dx &= \frac{\pi}{2} e^{-pr}, \\ \int_0^{\infty} \frac{\sin rx}{x(p^2+x^2)} dx &= \frac{\pi}{2p^2} (1 - e^{-pr}). \quad (r > 0, p > 0). \end{aligned}$$

Therefore

$$\begin{aligned} \int_0^{\infty} \sum_1^r \cos(a-\overline{2r-1}b)x \frac{dx}{p^2+x^2} &= \frac{\pi}{2p} \{e^{-(a-b)p} + e^{-(a-3b)p} + \dots \text{ to } r \text{ terms}\} \\ &= \frac{\pi}{4p} \frac{e^{-cp} - e^{-ap}}{\sinh bp}, \\ \int_0^{\infty} \sum_1^r (-1)^{r-1} \cos(a-\overline{2r-1}b)x \frac{dx}{p^2+x^2} &= \frac{\pi}{4p} \frac{e^{-ap} - (-1)^r e^{-rp}}{\cosh bp}, \\ \int_0^{\infty} \sum_1^r (-1)^{r-1} \sin(a-\overline{2r-1}b)x \frac{dx}{x(p^2+x^2)} &= \frac{\pi}{2p^2} \left\{ \frac{1 - (-1)^r e^{-ap}}{1 - (-1)^r} - \frac{e^{-ap} - (-1)^r e^{-rp}}{2 \cosh bp} \right\}, \\ \int_0^{\infty} \sum_1^r (-1)^{r-1} \sin(a-\overline{2r-1}b)x \frac{x dx}{p^2+x^2} &= \frac{\pi}{4} \frac{e^{-ap} - (-1)^r e^{-rp}}{\cosh bp}, \\ \int_0^{\infty} \sum_1^r \sin(a-\overline{2r-1}b)x \frac{x dx}{p^2+x^2} &= \frac{\pi}{4} \frac{e^{-rp} - e^{-ap}}{\sinh bp}. \end{aligned}$$

Hence, if $a=2rb+c$, $c^2 < b^2$, we have

$$\int_0^\infty \frac{\sin ax}{\sin bx} \frac{dx}{p^2+x^2} = 2 \int_0^\infty \sum_1^r \cos(a-2r-1)b)x \frac{dx}{p^2+x^2} + \int_0^\infty \frac{\sin cx}{\sin bx} \frac{dx}{p^2+x^2}$$

$$= \frac{\pi}{2p} \frac{e^{-cp} - e^{-ap}}{\sinh bp} + \frac{\pi}{2p} \left(\frac{\sinh cp}{\sinh bp}, 0 \text{ or } 1 \right),$$

according as $0 > c^2 > b^2$, or $c=0$ or $c=b$.

1116. Thus we have the several cases :

(A) $\int_0^\infty \frac{\sin ax}{\sin bx} \frac{dx}{p^2+x^2} = \frac{\pi \sinh ap}{2p \sinh bp}, \quad a < b,$

or $= 2 \cdot \frac{\pi}{2p} \frac{e^{-cp} - e^{-ap}}{2 \sinh bp} + \frac{\pi \sinh cp}{2p \sinh bp} = \frac{\pi \cosh cp - e^{-ap}}{2p \sinh bp}, \quad a=2rb+c,$

or $= 2 \cdot \frac{\pi}{2p} \frac{e^{-cp} - e^{-ap}}{2 \sinh bp} + 0 = \frac{\pi (1 - e^{-ap})}{2p \sinh bp}, \quad a=2rb, c=0,$

or $= 2 \cdot \frac{\pi}{2p} \frac{e^{-cp} - e^{-ap}}{2 \sinh bp} + \frac{\pi}{2p} = \frac{\pi \cosh bp - e^{-ap}}{2p \sinh bp}, \quad a=(2r+1)b, c=b,$

(B) $\int_0^\infty \frac{\cos ax}{\cos bx} \frac{dx}{p^2+x^2} = \frac{\pi \cosh ap}{2p \cosh bp}, \quad a < b,$

or $= 2 \cdot \frac{\pi}{2p} \frac{e^{-ap} - (-1)^r e^{-cp}}{2 \cosh bp} + (-1)^r \frac{\pi \cosh cp}{2p \cosh bp}$

$= \frac{\pi (-1)^r \sinh cp + e^{-ap}}{2p \cosh bp}, \quad a=2rb+c,$

or $= 2 \cdot \frac{\pi}{2p} \frac{e^{-ap} - (-1)^r e^{-cp}}{2 \cosh bp} + (-1)^r \frac{\pi}{2p} \operatorname{sech} bp$

$= \frac{\pi}{2p} \frac{e^{-ap}}{\cosh bp}, \quad a=2rb, c=0,$

or $= 2 \cdot \frac{\pi}{2p} \frac{e^{-ap} - (-1)^r e^{-cp}}{2 \cosh bp} + (-1)^r \frac{\pi}{2p}$

$= \frac{\pi (-1)^r \sinh bp + e^{-ap}}{2p \cosh bp}, \quad a=(2r+1)b, c=b.$

(C) $\int_0^\infty \frac{\sin ax}{\cos bx} \frac{dx}{x(p^2+x^2)} = \frac{\pi \sinh ap}{2p^2 \cosh bp}, \quad a < b,$

or $= 2 \cdot \frac{\pi}{2p^2} \left[\frac{1 - (-1)^r}{2} - \frac{e^{-ap} - (-1)^r e^{-cp}}{2 \cosh bp} \right] + (-1)^r \frac{\pi \sinh cp}{2p^2 \cosh bp}$

$= \frac{\pi}{2p^2} \left[1 - (-1)^r + \frac{(-1)^r \cosh cp - e^{-ap}}{\cosh bp} \right], \quad a=2rb+c,$

or $= 2 \cdot \frac{\pi}{2p^2} \left[\frac{1 - (-1)^r}{2} - \frac{e^{-ap} - (-1)^r e^{-cp}}{2 \cosh bp} \right] + 0$

$= \frac{\pi}{2p^2} \left[1 - (-1)^r + \frac{(-1)^r - e^{-ap}}{\cosh bp} \right], \quad a=2rb, c=0,$

or $= 2 \cdot \frac{\pi}{2p^2} \left[\frac{1 - (-1)^r}{2} - \frac{e^{-ap} - (-1)^r e^{-cp}}{2 \cosh bp} \right] + (-1)^r \frac{\pi}{2p^2} \tanh bp$

$= \frac{\pi}{2p^2} \left[1 - \frac{e^{-ap}}{\cosh bp} \right], \quad a=(2r+1)b, c=b.$

$$(D) \int_0^{\infty} \frac{\sin ax}{\cos bx} \frac{x dx}{p^2+x^2} = -\frac{\pi \sinh ap}{2 \cosh bp}, \quad a < b,$$

$$\text{or} \quad = 2 \cdot \frac{\pi}{2} \frac{e^{-ap} - (-1)^r e^{-cp}}{2 \cosh bp} - (-1)^r \frac{\pi}{2} \frac{\sinh cp}{\cosh bp}$$

$$= \frac{\pi}{2} \frac{e^{-ap} - (-1)^r \cosh cp}{\cosh bp}, \quad a = 2rb + c,$$

$$\text{or} \quad = 2 \cdot \frac{\pi}{2} \frac{e^{-ap} - (-1)^r e^{-cp}}{2 \cosh bp} + 0 = \frac{\pi}{2} \frac{e^{-ap} - (-1)^r}{\cosh bp}, \quad a = 2rb, \quad c = 0,$$

$$\text{or} \quad = 2 \cdot \frac{\pi}{2} \frac{e^{-ap} - (-1)^r e^{-cp}}{2 \cosh bp} + (-1)^r \left(\frac{\pi}{2} - \frac{\pi}{2} \tanh bp \right)$$

$$= \frac{\pi}{2} \frac{e^{-ap}}{\cosh bp}, \quad a = (2r+1)b, \quad c = b.$$

$$(E) \int_0^{\infty} \frac{\cos ax}{\sin bx} \frac{x dx}{p^2+x^2} = \frac{\pi \cosh ap}{2 \sinh bp}, \quad a < b,$$

$$\text{or} \quad = -2 \cdot \frac{\pi}{2} \frac{e^{-cp} - e^{-ap}}{2 \sinh bp} + \frac{\pi \cosh cp}{2 \sinh bp}$$

$$= \frac{\pi \sinh cp + e^{-ap}}{2 \sinh bp}, \quad a = 2rb + c,$$

$$\text{or} \quad = -2 \cdot \frac{\pi}{2} \frac{e^{-cp} - e^{-ap}}{2 \sinh bp} + \frac{\pi}{2} \operatorname{cosech} bp = \frac{\pi}{2} \frac{e^{-ap}}{\sinh bp}, \quad a = 2rb, \quad c = 0,$$

$$\text{or} \quad = -2 \cdot \frac{\pi}{2} \frac{e^{-cp} - e^{-ap}}{2 \sinh bp} + \frac{\pi}{2} \coth bp$$

$$= \frac{\pi \sinh bp + e^{-ap}}{2 \sinh bp}, \quad a = (2r+1)b, \quad c = b.$$

1117. Adding the results of (D) to p^2 times those of (C),

$$\int_0^{\infty} \frac{\sin ax}{\cos bx} \frac{dx}{x} = 0, \quad \frac{\pi}{2} \{1 - (-1)^r\}, \quad \frac{\pi}{2} \{1 - (-1)^r\} \text{ or } \frac{\pi}{2} \quad \text{according as}$$

$$a < b, \quad a = 2rb + c, \quad a = 2rb \quad \text{or } a = (2r+1)b.$$

If $a=b$ we have $\int_0^{\infty} \frac{\tan ax}{x} dx = \frac{\pi}{2}$ as established in Art. 1007, and used above. The majority of these results are due to Cauchy [*Mém. des Savans Étr.*, T. I.].*

1118. Some of the general results above ($a < b$ or $a = 2b + c$) may be derived from others by differentiation with regard to a ; bearing in mind that if b be kept constant $da = dc$.

Differentiation with regard to b , p or p^2 , or integration between specified limits, will furnish other results. For example, taking $a < b$ and starting with $\int_0^{\infty} \frac{\sin ax}{\sin bx} \frac{dx}{p^2+x^2} = \frac{\pi}{2p} \frac{\sinh ap}{\sinh bp}$ and integrating with regard to b between b_1 and b_2 , we have

$$\int_0^{\infty} \sin ax \log \frac{\tan \frac{b_1 x}{2}}{\tan \frac{b_2 x}{2}} \frac{dx}{x(p^2+x^2)} = \frac{\pi}{2p^2} \sinh ap \log \left\{ \frac{\tanh \frac{b_1 p}{2}}{\tanh \frac{b_2 p}{2}} \right\},$$

* See also Legendre, *Exercices*, vol. ii., p. 174; Gregory, *Ex.*, pp. 491-499.

or, differentiating with regard to p ,

$$\int_0^\infty \frac{\sin ax}{\sin bx} \frac{dx}{(p^2+x^2)^2} = -\frac{\pi}{4p} \frac{d}{dp} \left(\frac{\sinh ap}{p \sinh bp} \right).$$

Again, since $\int_0^\infty \frac{x \operatorname{cosech} x}{p^2+x^2} dx = \frac{\pi}{2} \operatorname{cosech} p$ (from Art. 1114), we have

$$\int_0^\infty \operatorname{cosech} x \left[\tan^{-1} \frac{p}{x} \right]_{p_1}^{p_2} dx = \frac{\pi}{2} \int_{p_1}^{p_2} \frac{2e^p dp}{e^{2p}-1} = \frac{\pi}{2} \left[\log \frac{e^p-1}{e^p+1} \right]_{p_1}^{p_2},$$

i.e.
$$\int_0^\infty \left(\tan^{-1} \frac{p_1}{x} - \tan^{-1} \frac{p_2}{x} \right) \frac{dx}{\sin x} = \frac{\pi}{2} \log \frac{\tanh \frac{p_1}{2}}{\tanh \frac{p_2}{2}}$$

or
$$\int_0^\infty \left(\tan^{-1} \frac{x}{p_1} - \tan^{-1} \frac{x}{p_2} \right) \frac{dx}{\sin x} = \frac{\pi}{2} \log \frac{\coth \frac{p_1}{2}}{\coth \frac{p_2}{2}},$$

and so on for other cases.

1119. Since
$$z \operatorname{cosech} z = 1 - \frac{2z^2}{z^2+\pi^2} + \frac{2z^2}{z^2+2^2\pi^2} - \frac{2z^2}{z^2+3^2\pi^2} + \dots,$$

$$\int_0^\infty \frac{z \operatorname{cosech} z}{z^2+b^2} dz = \frac{\pi}{2b} + 2 \sum_1^\infty (-1)^r \int_0^\infty \frac{z^2 dz}{(z^2+r^2\pi^2)(z^2+b^2)} = \frac{\pi}{2b} + \pi \sum_1^\infty \frac{(-1)^r}{(b+r\pi)},$$

and when b is an integral multiple of π , $=n\pi$ say, we have

$$\int_0^\infty \frac{z \operatorname{cosech} z}{z^2+n^2\pi^2} dz = \frac{1}{2n} - (-1)^n \left\{ \log 2 - \frac{1}{1} + \frac{1}{2} - \frac{1}{3} + \dots + (-1)^n \frac{1}{n} \right\}.$$

1120. **Some Special Forms** given by LEGENDRE (*Exercices*, p. 243) and LANDEN (*Math. Mem.*, p. 112, etc.).

Taking
$$-\frac{\pi^2}{6} = \int_0^1 \frac{\log(1-x)}{x} dx = \left(\int_0^a + \int_a^1 \right) \frac{\log(1-x)}{x} dx,$$

write $1-x=y$ in the second integral. Then ($x < 1$)

$$\begin{aligned} \int_a^1 \frac{\log(1-x)}{x} dx &= \int_0^{1-a} \frac{\log x}{1-x} dx \\ &= - \left[\log(1-x) \log x \right]_0^{1-a} + \int_0^{1-a} \frac{\log(1-x)}{x} dx \\ &= -\log a \log(1-a) + \int_0^{1-a} \frac{\log(1-x)}{x} dx. \end{aligned}$$

Hence
$$\left(\int_0^a + \int_0^{1-a} \right) \frac{\log(1-x)}{x} dx = \log a \log(1-a) - \frac{\pi^2}{6};$$

and if $\phi(a) \equiv \int_0^a \frac{\log(1-x)}{x} dx$, we have

$$\phi(a) + \phi(1-a) = \log a \log(1-a) - \frac{\pi^2}{6}, \dots\dots\dots(i)$$

and

$$\phi\left(\frac{1}{2}\right) = \frac{1}{2} \left(\log \frac{1}{2} \right)^2 - \frac{\pi^2}{12}, \quad (\alpha = \frac{1}{2}). \dots\dots\dots(ii)$$

Also $\phi'(x) = \{\log(1-x)\}'/x$, and

$$\frac{d}{dx} \phi\left(\frac{-x}{1-x}\right) = \phi'\left(\frac{-x}{1-x}\right) \frac{-1}{(1-x)^2} = \frac{\log\left(1 + \frac{x}{1-x}\right)}{-x} \frac{-1}{(1-x)^2} = \frac{1}{x(1-x)} \log \frac{1}{1-x};$$

$$\therefore \phi\left(\frac{-x}{1-x}\right) = -\int_0^x \left(\frac{1}{x} + \frac{1}{1-x}\right) \log(1-x) dx = -\phi(x) + \frac{1}{2} \{\log(1-x)\}^2.$$

Let $x = y/(1+y)$, then

$$\phi(-y) + \phi\left(\frac{y}{1+y}\right) = \frac{1}{2} \{\log(1+y)\}^2,$$

i.e. $\phi(-x) + \phi\left(\frac{x}{1+x}\right) = \frac{1}{2} \{\log(1+x)\}^2$(iii)

Again $\phi(x) = \int_0^x \frac{\log(1-x)}{x} dx = -\left(\frac{x}{1^2} + \frac{x^2}{2^2} + \frac{x^3}{3^2} + \dots\right);$

$$\therefore \phi(x) + \phi(-x) = -2\left(\frac{x^3}{2^2} + \frac{x^4}{4^2} + \frac{x^5}{6^2} + \dots\right) = \frac{1}{2} \phi(x^2); \dots\dots\dots(iv)$$

$$\therefore -\phi(x) + \frac{1}{2} \phi(x^2) + \phi\left(\frac{x}{1+x}\right) = \frac{1}{2} \{\log(1+x)\}^2. \dots\dots\dots(v)$$

(LEGENDRE.)

In the case $\frac{x}{1+x} = x^2$, i.e. $x(x+1) = 1$ or $x = \frac{\sqrt{5}-1}{2} = a$, say,

$$\frac{3}{2} \phi(a^2) - \phi(a) = \frac{1}{2} \{\log(1+a)\}^2,$$

i.e. $\frac{3}{2} \phi(1-a) - \phi(a) = \frac{1}{2} \left(\log \frac{1}{a}\right)^2 = \frac{1}{2} (\log a)^2.$

But $\phi(1-a) + \phi(a) = \log a \log(1-a) - \frac{\pi^2}{6} = \log a \log a^2 - \frac{\pi^2}{6}$
 $= 2(\log a)^2 - \frac{\pi^2}{6}.$

Hence solving

$$\phi(1-a) = (\log a)^2 - \frac{\pi^2}{15}, \quad \phi(a) = (\log a)^2 - \frac{\pi^2}{10},$$

where $a = \frac{\sqrt{5}-1}{2} = 2 \sin \frac{\pi}{10}$, $(1-a) = \sqrt{a^2} = \left(2 \sin \frac{\pi}{10}\right)^2.$

Thus

$$\int_0^{2 \sin \frac{\pi}{10}} \frac{\log(1-x)}{x} dx = \left(\log 2 \sin \frac{\pi}{10}\right)^2 - \frac{\pi^2}{10}, \quad \int_0^{4 \sin^2 \frac{\pi}{10}} \frac{\log(1-x)}{x} dx = \log\left(2 \sin \frac{\pi}{10}\right)^2 - \frac{\pi^2}{15}.$$

These curious results are due to LANDEN. They are quoted by Bertrand, *Calc. Int.*, pp. 216-217.

The series $\frac{x}{1^2} + \frac{x^2}{2^2} + \frac{x^3}{3^2} + \frac{x^4}{4^2} + \frac{x^5}{5^2} + \dots$ ad inf. is therefore summable in the four cases $x = \pm 1$, $x = \frac{1}{2}$, $x = 2 \sin \frac{\pi}{10}$, $x = \left(2 \sin \frac{\pi}{10}\right)^2.$

PROBLEMS.

Prove the following results

$$1. \int_0^{\frac{\pi}{2}} \cot \theta (\log \sec \theta)^3 d\theta = \frac{\pi^4}{240}. \quad 2. \int_0^{\frac{\pi}{4}} \tan \theta (\log \cot \theta)^3 d\theta = \frac{7\pi^4}{1920}.$$

$$3. \int_0^1 \frac{\left(\log \frac{1}{x}\right)^5}{1-x} dx = \frac{8\pi^6}{63}. \quad 4. \int_0^1 \frac{x^2 - x + 1}{1-x} \log \frac{1}{x} dx = \frac{\pi^2}{6} - \frac{1}{4}.$$

$$5. \int_0^{\frac{\pi}{2}} (\cos^4 \theta + \sin^2 \theta \cos^2 \theta + \sin^4 \theta) \tan \theta \log \operatorname{cosec} \theta d\theta = \frac{2\pi^2 - 3}{48}.$$

$$6. (i) \int_0^1 \frac{1+x}{1-x} \log \frac{1}{x} dx = \frac{\pi^2 - 3}{3},$$

$$(ii) \int_0^{\frac{\pi}{4}} \tan \theta \sec^2 \theta \sec 2\theta \log \cot \theta d\theta = \frac{\pi^2 - 3}{12}.$$

$$7. \int_0^1 \frac{(1+x)^2}{1-x} \log \frac{1}{x} dx = \frac{8\pi^2 - 39}{12}. \quad 8. \int_0^1 \frac{x^2 - 4}{x-1} \log \frac{1}{x} dx = \frac{2\pi^2 + 5}{4}.$$

$$9. \int_0^1 \frac{x^3}{1-x} \log \frac{1}{x} dx = \frac{6\pi^2 - 49}{36}.$$

$$10. \int_0^1 \frac{a_0 + a_1 x + a_2 x^2 + \dots + a_{n-1} x^{n-1} + a_n x^n}{1-x} \log \frac{1}{x} dx \\ = \frac{\pi^2}{6} \sum_0^n a_r - \frac{1}{1^2} \sum_1^n a_r - \frac{1}{2^2} \sum_2^n a_r - \dots - \frac{a_n}{n^2}.$$

$$11. \int_0^1 \frac{1-x^n}{(1-x)^2} \log \frac{1}{x} dx = \frac{n\pi^2}{6} - \frac{n-1}{1^2} - \frac{n-2}{2^2} - \frac{n-3}{3^2} - \dots - \frac{1}{(n-1)^2}.$$

$$12. \int_0^1 \frac{1 - (n+1)x^n + nx^{n+1}}{(1-x)^3} \log \frac{1}{x} dx = \frac{n(n+1)\pi^2}{12} - \frac{(n-1)(n+2)}{2 \cdot 1^2} \\ - \frac{(n-2)(n+3)}{2 \cdot 2^2} - \frac{(n-3)(n+4)}{2 \cdot 3^2} - \dots - \frac{1 \cdot 2n}{2(n-1)^2}.$$

$$13. (1) \int_0^{\frac{\pi}{2}} \log(\sec \theta) \frac{d\theta}{\sin \theta} = \frac{\pi^2}{8}, \quad (2) \int_0^{\frac{\pi}{2}} (\log \sec \theta)^3 \frac{d\theta}{\sin \theta} = \frac{\pi^4}{16},$$

$$(3) \int_0^{\frac{\pi}{2}} (\log \sec \theta)^5 \frac{d\theta}{\sin \theta} = \frac{\pi^6}{8}, \quad (4) \int_0^{\frac{\pi}{2}} (\log \sec \theta)^7 \frac{d\theta}{\sin \theta} = \frac{17\pi^8}{32}.$$

$$14. \int_0^1 x^{2n} \frac{\log \frac{1}{x}}{1-x^2} dx = \frac{\pi^2}{8} - \frac{1}{1^2} - \frac{1}{3^2} - \frac{1}{5^2} - \dots - \frac{1}{(2n-1)^2}.$$

15. $\int_0^1 \frac{a+bx^2+cx^4}{1-x^2} \log \frac{1}{x} dx = (a+b+c) \frac{\pi^2}{8} - \frac{a+b}{1^2} - \frac{c}{3^2}$.
16. $\int_0^1 \frac{1-x^6}{(1-x^2)^2} \log \frac{1}{x} dx = \frac{3\pi^2}{8} - \frac{19}{9}$. 17. $\int_0^1 \frac{1+x^6}{1-x^4} \log \frac{1}{x} dx = \frac{9\pi^2-8}{72}$.
18. $\int_0^1 \frac{x^{2n}}{1+x^2} \left(\log \frac{1}{x}\right)^2 dx$
 $= 2(-1)^n \left[\frac{\pi^3}{32} - \frac{1}{1^3} + \frac{1}{3^3} - \frac{1}{5^3} + \dots + (-1)^n \frac{1}{(2n-1)^3} \right]$.
19. $\int_0^1 \frac{a+bx^2+cx^4}{1+x^2} \left(\log \frac{1}{x}\right)^2 dx = (a-b+c) \frac{\pi^3}{16} + 2(b-c) + \frac{2c}{27}$.
20. $\int_0^1 \frac{1-x^6}{1-x^4} \left(\log \frac{1}{x}\right)^2 dx = \frac{\pi^3}{16} + \frac{2}{27}$.
21. $\int_0^1 \frac{1+x^6}{(1+x^2)^2} \left(\log \frac{1}{x}\right)^2 dx = \frac{3\pi^3}{16} - \frac{106}{27}$.
22. $\int_0^{\frac{\pi}{4}} (1+\tan^2 \theta + \tan^4 \theta) (\log \tan \theta)^2 d\theta = \frac{\pi^3}{16} + \frac{2}{27}$.
23. (1) $\int_0^{\frac{\pi}{4}} (\log \cot \theta)^2 d\theta = \frac{\pi^3}{16}$, (2) $\int_0^{\frac{\pi}{4}} (\log \cot \theta)^4 d\theta = \frac{5\pi^5}{64}$.
 (3) $\int_0^{\frac{\pi}{4}} (\log \cot \theta)^6 d\theta = \frac{61\pi^7}{256}$.
24. Prove that $\int_0^{\frac{\pi}{4}} \frac{\log \cot \theta}{(\sin^n \theta + \cos^n \theta)^2} \sin^{n-1} 2\theta d\theta = \frac{2^{n-1}}{n^2} \log 2$.
25. Establish the following results:
- (1) $\int_0^{\frac{\pi}{2}} \left\{ \frac{\log \tan \theta}{\sin\left(\theta - \frac{\pi}{4}\right)} \right\}^2 d\theta = \frac{4\pi^2}{3}$,
- (2) $\int_0^{\frac{\pi}{2}} \left\{ \frac{\log \tan \theta}{\sin\left(\theta - \frac{\pi}{4}\right)} \right\}^3 \cos \theta d\theta = 2\pi^2 \sqrt{2}$,
- (3) $\int_0^{\frac{\pi}{2}} \left\{ \frac{\log \tan \theta}{\sin\left(\theta - \frac{\pi}{4}\right)} \right\}^4 \cos^2 \theta d\theta = \frac{16\pi^2}{3} + \frac{32\pi^4}{45}$,
- (4) $\int_0^{\frac{\pi}{2}} \left\{ \frac{\log \tan \theta}{\sin\left(\theta - \frac{\pi}{4}\right)} \right\}^5 \cos^3 \theta d\theta = \left(\frac{20\pi^2}{3} + \frac{44\pi^4}{9} \right) \sqrt{2}$.

26. Show that

$$\int_0^{\frac{\pi}{2}} \frac{1 + 4 \sin^2 \theta + \sin^4 \theta}{\cos^6 \theta} \cdot \tan \theta (\log \operatorname{cosec} \theta)^{2n+2} d\theta = \frac{(n+1)(2n+1)}{8} \pi^{2n} B_{2n-1},$$

where B_{2n-1} is the n^{th} Bernoullian number.

27. Evaluate (1) $\int_0^{\frac{\pi}{2}} \frac{\cos^3 \theta \sin^{n-1} \theta d\theta}{\log \operatorname{cosec} \theta}$, (2) $\int_0^{\frac{\pi}{2}} \frac{\cos^5 \theta \sin^{n-1} \theta d\theta}{(\log \operatorname{cosec} \theta)^2}$,
 (3) $\int_0^{\frac{\pi}{2}} \frac{\cos^7 \theta \sin^{n-1} \theta d\theta}{(\log \operatorname{cosec} \theta)^3}$.

28. Show that $\int_0^{\infty} \frac{x^a \log x dx}{x-1} \frac{dx}{x} = \pi^2 \operatorname{cosec}^2 a \pi$ ($0 < a < 1$).

29. Establish the results (a) $\int_0^1 \frac{\log(1-x)}{2-x} dx = -\frac{\pi^2}{12}$,

(b) $\int_0^{\infty} \frac{\log x}{1-x^2} dx = \frac{\pi^2}{4}$, (c) $\int_0^1 \frac{(\log x)^7}{1-x^2} dx = -\frac{17\pi^8}{32}$.

30. Establish the results

(a) $\int_0^1 \frac{x^p - x^{-p}}{x^q - x^{-q}} \frac{dx}{x} = \frac{\pi}{2q} \tan \frac{p\pi}{2q}$ ($q > p > -q$);

(b) $\int_0^1 \frac{x^p + x^{-p}}{x^q + x^{-q}} \frac{dx}{x} = \frac{\pi}{2q} \sec \frac{p\pi}{2q}$ ($q > p > -q$).

31. Establish the result $\int_0^1 \frac{x^{a-1} - x^{1-a}}{1-x^2} dx = \frac{\pi}{2} \cot \frac{\pi a}{2}$ ($2 > a > 0$).

32. Prove that $\int_0^{\infty} \frac{\sinh px dx}{\cosh \pi x} \frac{dx}{x} = \log \tan \frac{p+\pi}{4}$ ($\pi > p > -\pi$),

33. Show that ($\pi > a > -\pi$),

(1) $\int_0^{\infty} \frac{\cosh ax}{\sinh \pi x} \sin rx dx = \frac{1}{2} \frac{\sinh r}{\cosh r + \cos a}$,

(2) $\int_0^{\infty} \frac{\sinh ax}{\sinh \pi x} \cos rx dx = \frac{1}{2} \frac{\sin a}{\cosh r + \cos a}$,

(3) $\int_0^{\infty} \frac{\sin rx}{\sinh \pi x} dx = \frac{1}{2} \tanh \frac{r}{2}$, (4) $\int_0^{\infty} \frac{\sinh ax}{\sinh \pi x} dx = \frac{1}{2} \tan \frac{a}{2}$,

(5) $\int_0^{\infty} \frac{x \cos rx}{\sinh \pi x} dx = \frac{1}{4} \operatorname{sech}^2 \frac{r}{2}$.

[GREGORY, *Ex.*, p. 495.]

34. Show that

$$(1) \int_0^{\infty} \frac{\cosh ax}{\cosh \pi x} \cos rx \, dx = \frac{\cosh \frac{r}{2} \cos \frac{a}{2}}{\cosh r + \cos a} \quad (\pi > a > -\pi),$$

$$(2) \int_0^{\infty} \frac{\cos rx}{\cosh \pi x} \, dx = \frac{1}{2} \operatorname{sech} \frac{r}{2},$$

$$(3) \int_0^{\infty} \frac{\operatorname{sech} \pi x}{p^2 + x^2} \, dx = \frac{1}{2p} \int_0^{\infty} e^{-pr} \operatorname{sech} \frac{r}{2} \, dr = \frac{1}{p} \int_0^1 \frac{z^{p-\frac{1}{2}}}{1+z} \, dz,$$

$$(4) \int_0^{\infty} \frac{\operatorname{sech} \pi x}{\frac{1}{4} + x^2} \, dx = \log_e 4, \quad (5) \int_0^{\infty} \frac{\operatorname{sech} \pi x}{1+x^2} \, dx = 2 - \frac{\pi}{2}.$$

[GREGORY, *Ex.*, p. 496.]

35. Show that

$$\int_0^{\infty} \frac{a+bx+cx^2}{\sqrt{e^{2x}-1}} \, dx = \frac{\pi}{2} \left[a + b \log 2 + c(\log 2)^2 + \frac{\pi^2 c}{12} \right]. \quad [a, 1891.]$$

36. Show that $\int_0^{\infty} \frac{\log \frac{1}{x}}{(1+x)^n} \, dx = \frac{1}{n-1} \left(\frac{1}{1} + \frac{1}{2} + \frac{1}{3} + \dots + \frac{1}{n-2} \right)$,

n being a positive integer > 2 .

37. Show that the integral $\int_0^{\infty} \frac{\sin ax}{\sin bx} \frac{dx}{1+x^2}$ has the value $\frac{\pi \sinh a}{2 \sinh b}$

if $a < b$, but has the value $\frac{\pi \cosh c - e^{-a}}{2 \sinh b}$ if $a > b$ and $= 2rb + c$, where r is an integer and $c < b$. [R. P.]

38. Prove that the coefficient of x^n in the expansion of $\sec x$ in ascending powers of x is equal to

$$\frac{1}{n!} \left(\frac{2}{\pi} \right)^{n+1} \int_0^{\frac{\pi}{2}} (\log \tan x)^n \, dx.$$

[MATH. TRIP., PART I., 1888.]

39. Show that $\int_0^{\infty} \frac{1-3x}{(1+x)^6} (\log x)^4 \, dx = 2\pi^2$.

40. If $\chi(x) \equiv x + \frac{x^3}{3^2} + \frac{x^5}{5^2} + \dots$, show that

$$(i) \chi \left(\frac{1-x}{1+x} \right) = \int_0^1 \frac{\log x}{1-x^2} \, dx,$$

$$(ii) \chi(x) + \chi \left(\frac{1-x}{1+x} \right) = \frac{\pi^2}{8} + \frac{1}{2} \log x \cdot \log \frac{1+x}{1-x},$$

$$(iii) \chi \left(\tan \frac{\pi}{8} \right) = \frac{\pi^2}{8} - \frac{1}{2} \left(\log \tan \frac{\pi}{8} \right)^2,$$

and that the value of the series $\chi(x)$ is known in the four cases

$$x = 1, \quad x = 2 \sin \frac{\pi}{10}, \quad x = \sqrt{5} - 2, \quad x = \tan \frac{\pi}{8}.$$

[LEGENDE, *Ex.*, p. 247.]

41. If $\Lambda(x) \equiv x + \frac{x^2}{2^3} + \frac{x^3}{3^3} + \frac{x^4}{4^3} + \dots$, show that, $\phi(x)$ being as defined in Art. 1120,

$$(i) \quad \Lambda(x) + \Lambda(1-x) + \Lambda\left(-\frac{x}{1-x}\right) \\ = \Lambda(1) - \log x \cdot \phi(x) - \log(1-x) \phi(1-x) \\ - \log \frac{x}{1-x} \cdot \phi\left(-\frac{x}{1-x}\right) + \log x \cdot \log^2(1-x) - \frac{1}{3} \log^3(1-x),$$

$$(ii) \quad \frac{7}{8} \Lambda(1) = \Lambda\left(\frac{1}{2}\right) + \frac{\pi^2}{12} \log 2 - \frac{1}{8} (\log 2)^3,$$

$$(iii) \quad \Lambda(1) = \frac{5}{4} \Lambda\left(4 \sin^2 \frac{\pi}{10}\right) - \frac{\pi^2}{6} \log\left(2 \sin \frac{\pi}{10}\right) + \frac{5}{8} \log^3\left(2 \sin \frac{\pi}{10}\right),$$

$$(iv) \quad \frac{1}{1^3} + \frac{1}{2^3} + \frac{1}{3^3} + \frac{1}{4^3} + \dots = \frac{\theta^2}{1^3} + \frac{\theta^4}{2^3} + \frac{\theta^6}{3^3} + \frac{\theta^8}{4^3} + \dots, \text{ where } \theta = 2 \sin \pi/10.$$

[LANDEN, *Math. Mem.*]

42. Prove that

$$\int_0^{2-\sqrt{2}} \log \frac{1-x}{1-\frac{x}{2}} \frac{dx}{x} = \frac{1}{2} \log(\sqrt{2}-1) \log\{2(\sqrt{2}-1)\} - \frac{1}{8} (\log 2)^2 - \frac{\pi^2}{24}.$$

[MORLEY, *E. T.*, 922A.]

43. If $f(x) = f(0) + xf'(0) + \dots + \frac{x^{n-1}}{(n-1)!} f^{(n-1)}(0) + \frac{x^n}{n!} f^{(n)}(\theta x)$ and r be a positive proper fraction, show that

$$\int_0^\infty \frac{f^{(n)}(\theta x)}{x^r} dx = \frac{\Gamma(n+1)\Gamma(r)}{\Gamma(n+r)} \int_0^\infty \frac{f^{(n)}(x)}{x^r} dx. \quad [\text{M. TRIP., 1883.}]$$

44. Prove that $\int_0^\infty \sin x^n dx = b\Gamma(1+1/n)$, ($n > 1$), where b is the real coefficient of the imaginary part of $(-1)^{\frac{1}{2n}}$, and hence find the value of the integral to four places of decimals when n is 2 or 3.

[SANJANA, *E. T.*, 13,609.]

45. Prove that

$$\int_0^\pi \int_0^1 \tan^{-1} \frac{2m \cos \theta}{1-m^2} d\theta dm = \frac{\pi^2}{4} - 2 \log 2, \quad (0 < m < 1).$$

[SANJANA, *E. T.*, 13,636.]

$$46. \text{ Prove that } \int_0^\pi \int_0^{\pi-\theta} \cos^4(\theta + \phi) \sec^2 \phi d\theta d\phi = \frac{1}{4}.$$

[W. J. C. MILLER, *E. T.*, 13,784.]

47. Prove that the value of

$$\iint x^{k-1} y^{-k} e^{x+y} dx dy \quad \text{is} \quad \frac{\pi}{\sin k\pi} (e^e - 1),$$

the integral being taken so as to give the variables all positive values consistent with the condition $x + y > c$; ($0 < k < 1$). [OX. II. P., 1885.]

48. Show that
$$\iint \dots \int \sqrt{\Delta} dx_1 dx_2 \dots dx_n = \frac{a^{\frac{n}{r}}}{nr^{n-1}} \frac{\left\{ \Gamma\left(\frac{1}{r}\right) \right\}^n}{\Gamma\left(\frac{n}{r}\right)},$$

where x_1, x_2, \dots, x_n are the roots and Δ the discriminant of the equation

$$x^n + p_1 x^{n-1} + \dots + p_{n-1} x + p_n = 0,$$

the integral being taken over all values of the variables such that the sum of the r^{th} powers of the coefficients in this equation, which are all positive, does not exceed a given quantity a .

[MATH. TRIP., 1884.]

49. If $I_m \equiv \int_0^{\alpha} (\cos x - \cos \alpha)^m dx$ and $J_m = \frac{1}{\sin^{2m+1} \alpha} I_m$, prove

(i) $mI_m + (2m-1) \cos \alpha I_{m-1} - (m-1) \sin^2 \alpha I_{m-2} = 0,$

(ii) $J_m = \frac{1}{m!} \left(\frac{1}{\sin \alpha} \frac{d}{d\alpha} \right)^m \left(\frac{\alpha}{\sin \alpha} \right).$

50. If $f(z)$ be an even function of z , and

$$I_{2n} = \int_0^{\infty} x^{2n} f\left(x - \frac{1}{x}\right) dx, \quad J_{2n} = \int_0^{\infty} x^{2n} f(x) dx,$$

show that $I_{2n} = J_0 + \frac{(n+1)n}{1 \cdot 2} J_2 + \frac{(n+2)(n+1)n(n-1)}{1 \cdot 2 \cdot 3 \cdot 4} J_4 + \dots + J_{2n}.$

[Use the expansion of $\frac{\cos m\theta}{\cos \theta}$ in powers of $\sin \theta$.] [CAUCHY.]

51. If $f(z)$ be an odd function of z , and

$$I'_{2n-1} = \int_0^{\infty} x^{2n-1} f\left(x - \frac{1}{x}\right) dx, \quad J'_{2n-1} = \int_0^{\infty} x^{2n-1} f(x) dx,$$

show that $I'_{2n-1} = \frac{n}{1} J'_1 + \frac{(n+1)n(n-1)}{1 \cdot 2 \cdot 3} J'_3 + \frac{(n+2)(n+1)n(n-1)(n-2)}{1 \cdot 2 \cdot 3 \cdot 4 \cdot 5} J'_5 + \dots + J'_{2n-1}.$

[GLAISHER.*]

52. If $f(z)$ be an even function of z , show that

$$\int_0^{\infty} f\left(x - \frac{1}{x}\right) dx = \int_0^{\infty} f(x) dx;$$

show also that $\int_0^{\infty} f\left(x - \frac{a}{x}\right) dx$ is independent of a .

[GLAISHER.]

* *Camb. Phil. Soc.*, 1876.

CHAPTER XXVIII.

DEFINITE INTEGRALS (III.).

1121. The Three Integrals,

$$I_1 = \int_0^\pi \cos p\theta \cos q\theta \, d\theta = 0 \quad (p \neq q); \quad \text{or} \quad \frac{\pi}{2} \quad (p = q),$$

$$I_2 = \int_0^\pi \sin p\theta \sin q\theta \, d\theta = 0 \quad (p \neq q); \quad \text{or} \quad \frac{\pi}{2} \quad (p = q),$$

$$I_3 = \int_0^\pi \sin p\theta \cos q\theta \, d\theta = 0 \quad (p+q \text{ even}); \quad \text{or} \quad \frac{2p}{p^2 - q^2} \quad (p+q \text{ odd}),$$

where p and q are integers, are of very special importance in the Theory of Definite Integrals.

$$\begin{aligned} \text{(i) } I_1 &= \int_0^\pi \cos p\theta \cos q\theta \, d\theta = \frac{1}{2} \int_0^\pi [\cos(p+q)\theta + \cos(p-q)\theta] \, d\theta \\ &= \frac{1}{2} \left[\frac{\sin(p+q)\theta}{p+q} + \frac{\sin(p-q)\theta}{p-q} \right]_0^\pi \\ &= 0, \text{ if } p \text{ and } q \text{ be unequal.} \end{aligned}$$

$$\text{But if } p=q, \quad \lim_{p \rightarrow q} \left[\frac{\sin(p-q)\theta}{p-q} \right]_0^\pi = \left[\theta \right]_0^\pi = \pi;$$

$$\therefore I_1 = 0 \text{ if } p \neq q \quad \text{and} \quad = \frac{\pi}{2} \text{ if } p=q.$$

In the latter case, viz. $p=q$, we may obtain the result directly without taking a limit; for

$$I_1 = \int_0^\pi \cos^2 p\theta \, d\theta = \int_0^\pi \frac{1 + \cos 2p\theta}{2} \, d\theta = \frac{1}{2} \left[\theta + \frac{\sin 2p\theta}{2p} \right]_0^\pi = \frac{\pi}{2}.$$

(ii) In the same way

$$I_2 = \int_0^\pi \sin p\theta \sin q\theta \, d\theta = 0 \text{ if } p \neq q \quad \text{or} \quad = \frac{\pi}{2} \text{ if } p=q.$$

(iii) Finally

$$\begin{aligned}
 I_3 &= \int_0^\pi \sin p\theta \cos q\theta \, d\theta = \frac{1}{2} \int_0^\pi [\sin(p+q)\theta + \sin(p-q)\theta] \, d\theta \\
 &= \frac{1}{2} \left[-\frac{\cos(p+q)\theta}{p+q} - \frac{\cos(p-q)\theta}{p-q} \right]_0^\pi \\
 &= \frac{1}{2} \left\{ \frac{1 - (-1)^{p+q}}{p+q} + \frac{1 - (-1)^{p-q}}{p-q} \right\} \\
 &= \frac{1 - (-1)^{p+q}}{2} \left\{ \frac{1}{p+q} + \frac{1}{p-q} \right\}, \text{ for } (-1)^{p-q} = (-1)^{p+q}, \\
 &= \{1 - (-1)^{p+q}\} \frac{p}{p^2 - q^2} \\
 &= 0 \quad \text{or} \quad \frac{2p}{p^2 - q^2},
 \end{aligned}$$

according as $p+q$ is even or odd, and p, q unequal.

And if $p=q$,

$$I_3 = \frac{1}{2} \int_0^\pi \sin 2p\theta \, d\theta = \frac{1}{2} \left[-\frac{\cos 2p\theta}{2p} \right]_0^\pi = \frac{1 - \cos 2p\pi}{4p} = 0, \text{ } p \text{ being an integer.}$$

1122. Important Applications.

If then $F(\theta)$ be a function of θ capable of convergent expansion in a series of sines or cosines of integral multiples of θ , say,

$$F(\theta) \equiv A_0 + A_1 \cos \theta + A_2 \cos 2\theta + \dots + A_n \cos n\theta + \dots,$$

$$\text{we have } \int_0^\pi F(\theta) \cos n\theta \, d\theta = A_n \cdot \frac{\pi}{2} \quad \text{and} \quad \int_0^\pi F(\theta) \, d\theta = A_0 \pi.$$

For upon multiplying by $\cos n\theta$ and integrating between limits 0 and π all the terms vanish except $A_n \int_0^\pi \cos^2 n\theta \, d\theta$, which becomes $A_n \cdot \frac{\pi}{2}$.

When therefore such an expansion for $F(\theta)$ is possible, this result gives a means of obtaining the several coefficients, viz.

$$A_0 = \frac{1}{\pi} \int_0^\pi F(\theta) \, d\theta, \quad A_n = \frac{2}{\pi} \int_0^\pi F(\theta) \cos n\theta \, d\theta.$$

Similarly, if $F(\theta)$ be expressible in the form

$$F(\theta) = B_1 \sin \theta + B_2 \sin 2\theta + \dots + B_n \sin n\theta + \dots$$

$$\text{we have } B_n = \frac{2}{\pi} \int_0^\pi F(\theta) \sin n\theta \, d\theta.$$

In the same way, if $F(\theta) \equiv A_0 + \sum_1^{\infty} A_r \cos r\theta$,

$$\begin{aligned} \text{then } \int_0^{\pi} F(\theta) \cos m\theta \cos n\theta \, d\theta &= \frac{1}{2} \int_0^{\pi} F(\theta) \{ \cos(m+n)\theta + \cos(m-n)\theta \} \, d\theta \\ &= \frac{1}{2} \cdot \frac{\pi}{2} (A_{m+n} + A_{m-n}), \quad m \neq n, \end{aligned}$$

and $\int_0^{\pi} F(\theta) \cos^2 m\theta \, d\theta = \frac{1}{2} \frac{\pi}{2} (2A_0 + A_{2m})$.

Again $\int_0^{\pi} F(\theta) \sin 2m\theta \, d\theta = \frac{4m}{4m^2 - 1^2} A_1 + \frac{4m}{4m^2 - 3^2} A_3 + \frac{4m}{4m^2 - 5^2} A_5 + \dots$

and so on for other similar applications of the rules.

1123. There are then two cases for which the rules are particularly useful.

1. When $F(\theta)$ is a known expansion of one of the forms

$$A_0 + \sum_1^{\infty} A_r \cos r\theta, \quad \sum_1^{\infty} B_r \sin r\theta,$$

i.e. such that the coefficients A_0, A_1, A_2, \dots or B_1, B_2, \dots are known, the method may be used to obtain definite integrals of the forms

$$\int_0^{\pi} F(\theta) \frac{\cos}{\sin} p\theta \, d\theta, \quad \int_0^{\pi} F(\theta) \frac{\cos}{\sin} p\theta \frac{\cos}{\sin} q\theta \, d\theta, \quad \int_0^{\pi} F(\theta) \frac{\cos^2}{\sin^2} p\theta \, d\theta,$$

etc.

2. Conversely, if $F(\theta)$ has not been already expanded in such form, *i.e.* in a convergent series of sines or cosines of integral multiples of θ , and if such expansion be possible, and if it be possible to obtain the value of $\int_0^{\pi} F(\theta) \cos n\theta \, d\theta$, or of $\int_0^{\pi} F(\theta) \sin n\theta \, d\theta$, the values of the several coefficients may then be deduced as $A_0 = \frac{1}{\pi} \int_0^{\pi} F(\theta) \, d\theta$,

$$A_n = \frac{2}{\pi} \int_0^{\pi} F(\theta) \cos n\theta \, d\theta, \quad B_n = \frac{2}{\pi} \int_0^{\pi} F(\theta) \sin n\theta \, d\theta, \quad (n > 0),$$

and the expansion thus obtained holds for all values of θ between $\theta=0$ and $\theta=\pi$.

1124. Again, if there be two convergent expansions of the same kind, viz.

$$\begin{aligned} F(\theta) &= A_0 + A_1 \cos \theta + A_2 \cos 2\theta + A_3 \cos 3\theta + \dots, \\ f(\theta) &= C_0 + C_1 \cos \theta + C_2 \cos 2\theta + C_3 \cos 3\theta + \dots, \end{aligned}$$

then plainly, upon multiplication and integration between limits 0 and π ,

$$A_0 C_0 + A_1 C_1 + A_2 C_2 + A_3 C_3 + \dots = \frac{2}{\pi} \int_0^\pi f(\theta) F(\theta) d\theta - A_0 C_0,$$

and as a case, if $f(\theta)$ and $F(\theta)$ be the same series,

$$A_0^2 + A_1^2 + A_2^2 + A_3^2 + \dots = \frac{2}{\pi} \int_0^\pi [F(\theta)]^2 d\theta - A_0^2.$$

1125. Further, if

$$\phi(x) \equiv A_0 + A_1 x + A_2 x^2 + A_3 x^3 + \dots,$$

$$\psi(x) = C_0 + C_1 x + C_2 x^2 + C_3 x^3 + \dots;$$

then writing $u = xe^{i\theta}$, $v = xe^{-i\theta}$,

$$\phi(u) + \phi(v) = 2(A_0 + A_1 x \cos \theta + A_2 x^2 \cos 2\theta + A_3 x^3 \cos 3\theta + \dots),$$

$$\psi(u) + \psi(v) = 2(C_0 + C_1 x \cos \theta + C_2 x^2 \cos 2\theta + C_3 x^3 \cos 3\theta + \dots);$$

$$\therefore A_0 C_0 \cdot \pi + A_1 C_1 x^2 \frac{\pi}{2} + A_2 C_2 x^4 \frac{\pi}{2} + A_3 C_3 x^6 \frac{\pi}{2} + \dots$$

$$= \int_0^\pi \frac{\phi(u) + \phi(v)}{2} \cdot \frac{\psi(u) + \psi(v)}{2} d\theta,$$

$$i.e. \quad A_0 C_0 + A_1 C_1 x^2 + A_2 C_2 x^4 + A_3 C_3 x^6 + \dots$$

$$= \frac{1}{2\pi} \int_0^\pi [\phi(u) + \phi(v)][\psi(u) + \psi(v)] d\theta - A_0 C_0;$$

and as a particular case, if ϕ and ψ be identical,

$$A_0^2 + A_1^2 x^2 + A_2^2 x^4 + A_3^2 x^6 + \dots = \frac{1}{2\pi} \int_0^\pi [\phi(u) + \phi(v)]^2 d\theta - A_0^2,$$

i.e. when the several terms of a series can be summed, we can express the sum of the squares of these terms in the form of a definite integral, and the sum of the squares of the coefficients will be expressible by means of the same integral, putting $x=1$, provided the series is convergent for that value of x , *i.e.*

$$A_0^2 + A_1^2 + A_2^2 + A_3^2 + \dots = \frac{1}{2\pi} \int_0^\pi [\phi(e^{i\theta}) + \phi(e^{-i\theta})]^2 d\theta - A_0^2.$$

1126. Ex. Thus for the series $(1+x)^n$, n being a positive integer,

$$\begin{aligned} A_0^2 + A_1^2 + A_2^2 + \dots &= \frac{1}{2\pi} \int_0^\pi [(1+e^{i\theta})^n + (1+e^{-i\theta})^n]^2 d\theta - 1 \\ &= \frac{1}{2\pi} \int_0^\pi \left(e^{\frac{i n \theta}{2}} + e^{-\frac{i n \theta}{2}} \right)^2 \left(e^{\frac{i \theta}{2}} + e^{-\frac{i \theta}{2}} \right)^{2n} d\theta - 1 = \frac{2^{2n+1}}{\pi} \int_0^\pi \left(\cos \frac{n\theta}{2} \cos \frac{\theta}{2} \right)^2 d\theta - 1. \end{aligned}$$

Similarly for the series $e^x = 1 + \frac{x}{1} + \frac{x^2}{2} + \dots$, we have

$$\begin{aligned} 1^2 + \left(\frac{1}{1}\right)^2 + \left(\frac{1}{2}\right)^2 + \left(\frac{1}{3}\right)^2 + \dots \text{ ad. inf.} &= \frac{1}{2\pi} \int_0^\pi (e^{e^{i\theta}} + e^{e^{-i\theta}})^2 d\theta - 1 \\ &= \frac{2}{\pi} \int_0^\pi e^{2 \cos \theta} \cos^2(\sin \theta) d\theta - 1. \end{aligned}$$

1127. Again we may express as a definite integral the sum of the first r terms of any series,

$$\phi(x) = A_0 + A_1x + A_2x^2 + A_3x^3 + \dots \text{ ad inf.}$$

For writing as before, $u = xe^{i\theta}$, $v = xe^{-i\theta}$,

$$\frac{\phi(u) + \phi(v)}{2} = A_0 + A_1x \cos \theta + A_2x^2 \cos 2\theta + A_3x^3 \cos 3\theta + \dots$$

to an infinite number of terms.

Also
$$\frac{\sin \frac{r\theta}{2}}{\sin \frac{\theta}{2}} \cos \frac{(r-1)\theta}{2} = 1 + \cos \theta + \cos 2\theta + \dots + \cos (r-1)\theta.$$

Multiply and integrate from 0 to π ;

$$\begin{aligned} \therefore A_0 + A_1x + A_2x^2 + A_3x^3 + \dots + A_{r-1}x^{r-1} \\ = \frac{2}{\pi} \int_0^\pi \frac{\phi(u) + \phi(v)}{2} \frac{\sin \frac{r\theta}{2}}{\sin \frac{\theta}{2}} \cos \frac{(r-1)\theta}{2} d\theta - A_0. \end{aligned}$$

1128. If we take as our auxiliary series,

$$\frac{\sin \frac{r\theta}{2}}{\sin \frac{\theta}{2}} \cos \frac{2k+r-1}{2} \theta = \cos k\theta + \cos (k+1)\theta + \cos (k+2)\theta + \dots \text{ to } r \text{ terms,}$$

we have

$$\begin{aligned} A_kx^k + A_{k+1}x^{k+1} + \dots + A_{k+r-1}x^{k+r-1} \\ = \frac{2}{\pi} \int_0^\pi \frac{\phi(u) + \phi(v)}{2} \frac{\sin \frac{r\theta}{2}}{\sin \frac{\theta}{2}} \cos \frac{2k+r-1}{2} \theta d\theta, \end{aligned}$$

i.e. the sum of r terms of $\phi(x)$ starting from any particular term, $k > 0$.

Obviously other modifications may be made. And provided $\phi(x)$ remains a convergent series when $x=1$, we may put 1 for x before the integration is performed if it be required to sum the several coefficients in any of the above cases.

1129. **Examples of Integrals derived from the Foregoing Principles.**

Since
$$2^{2n} \cos^{2n} x = 2 \sum_{p=0}^{p=n-1} {}^{2n}C_p \cos (2n-2p)x + {}^{2n}C_n,$$

$$2^{2n+1} \cos^{2n+1} x = 2 \sum_{p=0}^{p=n} {}^{2n+1}C_p \cos (2n+1-2p)x,$$

$$(-1)^n 2^{2n} \sin^{2n} x = 2 \sum_{p=0}^{p=n-1} (-1)^p {}^{2n}C_p \cos (2n-2p)x + (-1)^n {}^{2n}C_n,$$

and
$$(-1)^n 2^{2n+1} \sin^{2n+1} x = 2 \sum_{p=0}^{p=n} (-1)^p {}^{2n+1}C_p \sin (2n+1-2p)x,$$

we have, by aid of the previous article,

$$\int_0^{\pi} \cos^{2n} x \cos 2nx \, dx = \frac{\pi}{2^{2n}}, \quad \int_0^{\pi} \cos^{2n} x \cos (2n-2p)x \, dx = {}^{2n}C_p \frac{\pi}{2^{2n}},$$

$$\int_0^{\pi} \cos^{2n} x \cos rx \, dx = 0, \quad (r \neq 0),$$

where r is odd, or even and not lying within the range from $2n$ to $-2n$ inclusive. (A)

$$\int_0^{\pi} \cos^{2n+1} x \cos (2n+1)x \, dx = \frac{\pi}{2^{2n+1}},$$

$$\int_0^{\pi} \cos^{2n+1} x \cos (2n+1-2p)x \, dx = {}^{2n+1}C_p \cdot \frac{\pi}{2^{2n+1}},$$

$$\int_0^{\pi} \cos^{2n+1} x \cos rx \, dx = 0, \quad (r \neq 0),$$

where r is even, or odd and not lying within the range from $2n+1$ to $-(2n+1)$ inclusive. (B)

$$\int_0^{\pi} \sin^{2n} x \cos 2nx \, dx = (-1)^n \frac{\pi}{2^{2n}},$$

$$\int_0^{\pi} \sin^{2n} x \cos (2n-2p)x \, dx = (-1)^{n+p} {}^{2n}C_p \frac{\pi}{2^{2n}},$$

$$\int_0^{\pi} \sin^{2n} x \cos rx \, dx = 0, \quad (r \neq 0),$$

where r is odd, or even and not lying within the range from $2n$ to $-2n$ inclusive. (C)

$$\int_0^{\pi} \sin^{2n+1} x \sin (2n+1)x \, dx = (-1)^n \frac{\pi}{2^{2n+1}},$$

$$\int_0^{\pi} \sin^{2n+1} x \sin (2n+1-2p)x \, dx = (-1)^{n+p} {}^{2n+1}C_p \frac{\pi}{2^{2n+1}},$$

$$\int_0^{\pi} \sin^{2n+1} x \sin rx \, dx = 0,$$

where r is even, or odd and not lying within the range from $2n+1$ to $-(2n+1)$ inclusive. (D)

All six statements in (A) and (B) may be summed up in the result

$$\int_0^{\pi} \cos^{\lambda} x \cos \mu x \, dx = {}^{\lambda}C_{\frac{\lambda-\mu}{2}} \frac{\pi}{2^{\lambda}}, \quad (\mu \neq 0),$$

where ${}^{\lambda}C_{\frac{\lambda-\mu}{2}}$ is the number of combinations of λ things $\frac{\lambda-\mu}{2}$ at a time and is unity when $\mu = \lambda$, or zero if $\frac{\lambda-\mu}{2}$ be not a positive integer.

The three statements in (C) may be similarly summed up as

$$\int_0^{\pi} \sin^{\lambda} x \cos \mu x \, dx = {}^{\lambda}C_{\frac{\lambda-\mu}{2}} \frac{\pi}{2^{\lambda}} (-1)^{\frac{2\lambda-\mu}{2}} \quad (\lambda \text{ even}, \mu \neq 0),$$

and the three statements in (D) may be summed up as

$$\int_0^{\pi} \sin^{\lambda} x \sin \mu x \, dx = {}^{\lambda}C_{\frac{\lambda-\mu}{2}} \frac{\pi}{2^{\lambda}} (-1)^{\frac{2\lambda-\mu-1}{2}} \quad (\lambda \text{ odd}).$$

$$1130. \text{ Similarly, (1) } 2^{2n} \int_0^\pi \cos^{2n} x \sin 2sx \, dx$$

$$= \int_0^\pi \left[2 \sum_{p=0}^{p=n-1} {}^{2n}C_p \cos 2(n-p)x \sin 2sx + {}^{2n}C_n \sin 2sx \right] dx$$

$$= 0, \text{ by Art. 1121 (iii).}$$

$$(2) 2^{2n} \int_0^\pi \cos^{2n} x \sin(2s+1)x \, dx$$

$$= \int_0^\pi \left[2 \sum_{p=0}^{p=n-1} {}^{2n}C_p \cos 2(n-p)x \sin(2s+1)x + {}^{2n}C_n \sin(2s+1)x \right] dx$$

$$= 2 \sum_{p=0}^{p=n-1} {}^{2n}C_p \cdot \frac{2(2s+1)}{(2s+1)^2 - (2n-2p)^2} + {}^{2n}C_n \cdot \frac{2}{2s+1}.$$

$$(3) 2^{2n+1} \int_0^\pi \cos^{2n+1} x \sin 2sx \, dx$$

$$= \int_0^\pi \left[2 \sum_{p=0}^{p=n} {}^{2n+1}C_p \cos(2n+1-2p)x \sin 2sx \right] dx$$

$$= 2 \sum_{p=0}^{p=n} {}^{2n+1}C_p \frac{2 \cdot 2s}{(2s)^2 - (2n+1-2p)^2}.$$

$$(4) 2^{2n+1} \int_0^\pi \cos^{2n+1} x \sin(2s+1)x \, dx$$

$$= \int_0^\pi \left[2 \sum_{p=0}^{p=n} {}^{2n+1}C_p \cos(2n+1-2p)x \sin(2s+1)x \right] dx$$

$$= 0.$$

$$(5) (-1)^n 2^{2n} \int_0^\pi \sin^{2n} x \sin 2sx \, dx$$

$$= \int_0^\pi \left[2 \sum_{p=0}^{p=n-1} (-1)^p {}^{2n}C_p \cos(2n-2p)x \sin 2sx + (-1)^n {}^{2n}C_n \sin 2sx \right] dx$$

$$= 0.$$

$$(6) (-1)^n 2^{2n} \int_0^\pi \sin^{2n} x \sin(2s+1)x \, dx$$

$$= \int_0^\pi \left[2 \sum_{p=0}^{p=n-1} (-1)^p {}^{2n}C_p \cos(2n-2p)x \sin(2s+1)x + (-1)^n {}^{2n}C_n \sin(2s+1)x \right] dx$$

$$= 2 \sum_{p=0}^{p=n-1} (-1)^p {}^{2n}C_p \frac{2(2s+1)}{(2s+1)^2 - (2n-2p)^2} + (-1)^n {}^{2n}C_n \frac{2}{2s+1}.$$

$$(7) (-1)^n 2^{2n+1} \int_0^\pi \sin^{2n+1} x \cos 2sx \, dx$$

$$= \int_0^\pi \left[2 \sum_{p=0}^{p=n} (-1)^p {}^{2n+1}C_p \sin(2n+1-2p)x \cos 2sx \right] dx$$

$$= 2 \sum_{p=0}^{p=n} (-1)^p {}^{2n+1}C_p \frac{2(2n+1-2p)}{(2n+1-2p)^2 - (2s)^2}.$$

$$(8) (-1)^n 2^{2n+1} \int_0^\pi \sin^{2n+1} x \cos(2s+1)x \, dx$$

$$= \int_0^\pi \left[2 \sum_{p=0}^{p=n} (-1)^p {}^{2n+1}C_p \sin(2n+1-2p)x \cos(2s+1)x \right] dx$$

$$= 0.$$

Thus we have considered in Arts. 1129 and 1130 all cases of

$$\int_0^\pi \cos^\lambda x \cos \mu x dx, \quad \int_0^\pi \cos^\lambda x \sin \mu x dx,$$

$$\int_0^\pi \sin^\lambda x \cos \mu x dx, \quad \int_0^\pi \sin^\lambda x \sin \mu x dx,$$

for which λ and μ are integers, λ being positive.

1131. The eight expressions

$$\cos^{2n} x \cos 2s x, \quad \cos^{2n+1} x \cos (2s+1)x, \quad \cos^{2n} x \sin (2s+1)x, \quad \cos^{2n+1} x \sin 2s x,$$

$$\sin^{2n} x \cos 2s x, \quad \sin^{2n+1} x \cos 2s x, \quad \sin^{2n} x \sin (2s+1)x, \quad \sin^{2n+1} x \sin (2s+1)x,$$

have the same values when we put $\pi - x$ in place of x .

But the eight expressions

$$\cos^{2n} x \cos (2s+1)x, \quad \cos^{2n+1} x \cos 2s x, \quad \cos^{2n} x \sin 2s x, \quad \cos^{2n+1} x \sin (2s+1)x$$

$$\sin^{2n} x \cos (2s+1)x, \quad \sin^{2n+1} x \cos (2s+1)x, \quad \sin^{2n} x \sin 2s x, \quad \sin^{2n+1} x \sin 2s x,$$

change sign if we put $\pi - x$ in place of x .

From these considerations the integrals from 0 to $\frac{\pi}{2}$ of the eight in the first group are each half the result from 0 to π .

And the integrals of the eight in the second group from 0 to π all vanish. This is in conformity with the results found.

The integrals from 0 to $\frac{\pi}{2}$ of the eight in the second group must therefore be found by another method, viz. the reduction formulae of Arts. 249-257.

1132. We have also, by putting for $\sin^{2n} x$ its equivalent in a series of

cosines of even multiples of x , say $A_0 + \sum_1^n A_{2r} \cos 2rx$,

$$\int_0^\pi x \sin^{2n} x dx = \int_0^\pi x (A_0 + A_2 \cos 2x + A_4 \cos 4x + \dots + A_{2n} \cos 2nx) dx;$$

and therefore integrating by parts,

$$\int_0^\pi x \sin^{2n} x dx = \left[x \left\{ A_0 x + A_2 \frac{\sin 2x}{2} + A_4 \frac{\sin 4x}{4} + \dots + A_{2n} \frac{\sin 2nx}{2n} \right\} \right]_0^\pi$$

$$- \left[A_0 \frac{x^2}{2} - A_2 \frac{\cos 2x}{2^2} + \dots \right]_0^\pi$$

$$= A_0 \left(\pi^2 - \frac{\pi^2}{2} \right) = \frac{\pi^2}{2} A_0 = \frac{\pi^2}{2} \frac{1}{2^{2n}} {}^{2n}C_n = \frac{\pi^2 (2n)!}{2^{2n+1} (n!)^2},$$

with other similar results.

This may be obtained otherwise, thus :

$$\int_0^\pi x \sin^{2n} x dx = - \int_\pi^0 (\pi - x) \sin^{2n} x dx = \int_0^\pi (\pi - x) \sin^{2n} x dx;$$

$$\therefore \int_0^\pi x \sin^{2n} x dx = \frac{\pi}{2} \int_0^\pi \sin^{2n} x dx$$

$$= \pi \frac{2n-1}{2n} \frac{2n-3}{2n-2} \dots \frac{1}{2} \cdot \frac{\pi}{2} = \pi^2 \frac{(2n)!}{2^{2n+1} (n!)^2}$$

1133. The former process may be extended to find $\int_0^\pi x^p \sin^{2n} x dx$, where p and n are positive integers.

Thus

$$\begin{aligned} \int_0^\pi x^p \sin^{2n} x dx &= \int_0^\pi x^p (A_0 + \sum_1^n A_{2r} \cos 2rx) dx = A_0 \frac{\pi^{p+1}}{p+1} + \int_0^\pi x^p \sum_1^n A_{2r} \cos 2rx dx \\ &= A_0 \frac{\pi^{p+1}}{p+1} + \left[x^p \sum_1^n \frac{A_{2r}}{2r} \sin 2rx - px^{p-1} \left(-\sum_1^n \frac{A_{2r}}{(2r)^2} \cos 2rx \right) \right. \\ &\quad + p(p-1)x^{p-2} \left(-\sum_1^n \frac{A_{2r}}{(2r)^3} \sin 2rx \right) - p(p-1)(p-2)x^{p-3} \sum_1^n \frac{A_{2r}}{(2r)^4} \cos 2rx + \dots \\ &\quad \left. + (-1)^p p! \sum_1^n \frac{A_{2r}}{(2r)^{p+1}} \cos \left(2rx - p + 1 \frac{\pi}{2} \right) \right]_0^\pi \\ &= A_0 \frac{\pi^{p+1}}{p+1} + p\pi^{p-1} \sum_1^n \frac{A_{2r}}{(2r)^2} - p(p-1)(p-2)\pi^{p-3} \sum_1^n \frac{A_{2r}}{(2r)^4} + \dots, \end{aligned}$$

and p being integral and positive the series will terminate.

Also

$$A_0 = \frac{1}{2^{2n}} {}^{2n}C_n, \quad A_2 = -\frac{1}{2^{2n-1}} {}^{2n}C_{n-1}, \quad A_4 = \frac{1}{2^{2n-1}} {}^{2n}C_{n-2}, \text{ etc., } A_{2r} = \frac{(-1)^r}{2^{2n-1}} {}^{2n}C_{n-r}.$$

Hence

$$\begin{aligned} \int_0^\pi x^p \sin^{2n} x dx &= \frac{1}{2^{2n-1}} \left\{ \frac{1}{2} \frac{\pi^{p+1}}{p+1} {}^{2n}C_n + p\pi^{p-1} \sum_1^n \frac{(-1)^r}{(2r)^2} {}^{2n}C_{n-r} \right. \\ &\quad \left. - p(p-1)(p-2)\pi^{p-3} \sum_1^n \frac{(-1)^r}{(2r)^4} {}^{2n}C_{n-r} + \dots \right\}. \end{aligned}$$

We may obtain similar results for

$$\int_0^\pi x^p \sin^{2n+1} x dx, \quad \int_0^\pi x^p \cos^{2n} x dx, \quad \int_0^\pi x^p \cos^{2n+1} x dx,$$

or in fact for any integral of form $\int_0^\pi x^p F(x) dx$, where $F(x)$ can be expressed as a series of sines or cosines of integral multiples of x . For instance,

$$\begin{aligned} \int_0^\pi x^p \cos nx \frac{\sin(n+1)x}{\sin x} dx &= \int_0^\pi x^p (1 + \cos 2x + \cos 4x + \dots + \cos 2nx) dx \\ &= \frac{\pi^{p+1}}{p+1} + \left[x^p \sum_1^n \frac{\sin 2rx}{2r} - px^{p-1} \sum_1^n \frac{(-1) \cos 2rx}{(2r)^2} + p(p-1)x^{p-3} \sum_1^n \frac{(-1) \sin 2rx}{(2r)^3} - \dots \right. \\ &\quad \left. + (-1)^p p! \sum_1^n \frac{\cos \left(2rx - p + 1 \frac{\pi}{2} \right)}{(2r)^{p+1}} \right]_0^\pi \\ &= \frac{\pi^{p+1}}{p+1} + p \frac{\pi^{p-1}}{2^2} \sum_1^n \frac{1}{r^2} - p(p-1)(p-2) \frac{\pi^{p-3}}{2^4} \sum_1^n \frac{1}{r^4} + \dots \end{aligned}$$

1134. Results derivable from Well-known Series.

Many well-known series are established in books on Trigonometry whose terms involve sines or cosines of integral multiples of θ . And such series furnish many definite integrals by the application of the rules of Art. 1121.

For convenience we quote a number of the more important :

1. $\frac{1-a^2}{1-2a \cos \theta + a^2} = 1 + 2a \cos \theta + 2a^2 \cos 2\theta + 2a^3 \cos 3\theta + \dots, \quad a^2 < 1,$
- or $= -1 - \frac{2}{a} \cos \theta - \frac{2}{a^2} \cos 2\theta - \frac{2}{a^3} \cos 3\theta - \dots, \quad a^2 > 1,$
2. $\frac{\sin \theta}{1-2a \cos \theta + a^2} = \sin \theta + a \sin 2\theta + a^2 \sin 3\theta + \dots, \quad a^2 < 1,$
- or $= \frac{1}{a^2} \sin \theta + \frac{1}{a^3} \sin 2\theta + \frac{1}{a^4} \sin 3\theta + \dots, \quad a^2 > 1,$
3. $\frac{1-a \cos \theta}{1-2a \cos \theta + a^2} = 1 + a \cos \theta + a^2 \cos 2\theta + a^3 \cos 3\theta + \dots, \quad a^2 < 1,$
- or $= -\frac{1}{a} \cos \theta - \frac{1}{a^2} \cos 2\theta - \frac{1}{a^3} \cos 3\theta - \dots, \quad a^2 > 1,$
4. $\frac{\cos \theta}{1-2a \cos \theta + a^2} = \frac{a}{1-a^2} + \frac{1+a^2}{1-a^2} (\cos \theta + a \cos 2\theta + a^2 \cos 3\theta + \dots), \quad a^2 < 1,$
- or $= \frac{1}{a(a^2-1)} + \frac{1}{a^2} \frac{a^2+1}{a^2-1} \left(\cos \theta + \frac{1}{a} \cos 2\theta + \frac{1}{a^2} \cos 3\theta + \dots \right), \quad a^2 > 1.$
5. $\log(1-2a \cos \theta + a^2) = -2(a \cos \theta + \frac{1}{2} a^2 \cos 2\theta + \frac{1}{3} a^3 \cos 3\theta + \dots), \quad a^2 < 1,$
- or $= \log a^2 - 2 \left(\frac{1}{a} \cos \theta + \frac{1}{2a^2} \cos 2\theta + \frac{1}{3a^3} \cos 3\theta + \dots \right), \quad a^2 > 1.$
6. $\tan^{-1} \frac{a \sin \theta}{1-a \cos \theta} = a \sin \theta + \frac{1}{2} a^2 \sin 2\theta + \frac{1}{3} a^3 \sin 3\theta + \dots, \quad a^2 < 1,$
- or $= \pi - \theta - \left(\frac{1}{a} \sin \theta + \frac{1}{2a^2} \sin 2\theta + \frac{1}{3a^3} \sin 3\theta + \dots \right), \quad a^2 > 1$

and in each of these cases a may be changed to $-a$.

We also have

7. $\log \left(2 \cos \frac{\theta}{2} \right) = \cos \theta - \frac{1}{2} \cos 2\theta + \frac{1}{3} \cos 3\theta - \dots, \quad (-\pi < \theta < \pi).$
8. $\log \left(2 \sin \frac{\theta}{2} \right) = -\cos \theta - \frac{1}{2} \cos 2\theta - \frac{1}{3} \cos 3\theta - \dots, \quad (0 < \theta < 2\pi).$
9. $\log(2 \sin \theta) = -\cos 2\theta - \frac{1}{2} \cos 4\theta - \frac{1}{3} \cos 6\theta - \dots, \quad (0 < \theta < \pi).$
10. $\frac{\theta}{2} = \sin \theta - \frac{1}{2} \sin 2\theta + \frac{1}{3} \sin 3\theta - \dots, \quad (-\pi < \theta < \pi).$
11. $\frac{\pi - \theta}{2} = \sin \theta + \frac{1}{2} \sin 2\theta + \frac{1}{3} \sin 3\theta + \dots, \quad (0 < \theta < \pi).$
12. $\frac{\pi}{4} = \sin \theta + \frac{1}{3} \sin 3\theta + \frac{1}{5} \sin 5\theta + \dots, \quad (0 < \theta < \pi).$

It will be noted that if $n < 1$,

$$\log(1-n \cos \theta) \text{ is a case of } \log \left(1 - \frac{2a}{1+a^2} \cos \theta \right),$$

the value of a being given by $1+a^2 = \frac{2a}{n}$,

or putting $a = \tan \frac{\alpha}{2}, \quad n = \sin \alpha.$

1135. Derivation of Other Series.

Other series may be obtained by differentiation with regard to θ .

Let $u \equiv 1 - 2a \cos \theta + a^2$.

Taking the series

$$\frac{1 - a^2}{u} = 1 + 2a \cos \theta + 2a^2 \cos 2\theta + 2a^3 \cos 3\theta + \dots \dots \dots (1), \quad a^2 < 1,$$

and $\frac{a \sin \theta}{u} = a \sin \theta + a^2 \sin 2\theta + a^3 \sin 3\theta + \dots \dots \dots (2), \quad a^2 < 1.$

Differentiate (1) with regard to θ ,

$$\frac{2a(1 - a^2) \sin \theta}{u^2} = 2a \sin \theta + 4a^2 \sin 2\theta + 6a^3 \sin 3\theta + \dots, \quad a^2 < 1,$$

i.e. $(1 - a^2) \frac{\sin \theta}{u^2} = \sin \theta + 2a \sin 2\theta + 3a^2 \sin 3\theta + \dots + na^{n-1} \sin n\theta + \dots (3), \quad a^2 < 1,$

and differentiating (2) with regard to θ ,

$$\frac{(1 + a^2) \cos \theta - 2a}{u^2} = \cos \theta + 2a \cos 2\theta + 3a^2 \cos 3\theta + \dots + na^{n-1} \cos n\theta + \dots (4), \quad a^2 < 1.$$

Equation (1) may be written,

$$\frac{(1 - a^2)(1 - 2a \cos \theta + a^2)}{u^2} = 1 + 2a \cos \theta + 2a^2 \cos 2\theta + \dots + 2a^n \cos n\theta + \dots \dots \dots (5), \quad a^2 < 1.$$

Multiply (4) and (5) by $2a(1 - a^2)$ and $1 + a^2$ respectively, and add, then

$$\frac{(1 - a^2)^3}{u^2} = 1 + a^2 + 4a \cos \theta + 2a^2(3 - a^2) \cos 2\theta + 2a^3(4 - 2a^2) \cos 3\theta + \dots + 2a^n \{n(1 - a^2) + (1 + a^2)\} \cos n\theta + \dots \dots \dots (6), \quad a^2 < 1,$$

and so on with further differentiations.

And similarly when a^2 is > 1 , we have

$$\frac{a^2 - 1}{u} = 1 + \frac{2}{a} \cos \theta + \frac{2}{a^2} \cos 2\theta + \frac{2}{a^3} \cos 3\theta + \dots, \dots \dots (1')$$

$$\frac{a \sin \theta}{u} = \frac{1}{a} \sin \theta + \frac{1}{a^2} \sin 2\theta + \frac{1}{a^3} \sin 3\theta + \dots \dots \dots (2')$$

Differentiate (1') with regard to θ ,

$$\frac{2a(a^2 - 1) \sin \theta}{u^2} = \frac{2}{a} \sin \theta + \frac{4}{a^2} \sin 2\theta + \frac{6}{a^3} \sin 3\theta + \dots,$$

or $\frac{(a^2 - 1) \sin \theta}{u^2} = \frac{1}{a^2} \sin \theta + \frac{2}{a^3} \sin 2\theta + \frac{3}{a^4} \sin 3\theta + \dots, \dots \dots (3')$

and differentiating (2') with regard to θ ,

$$\frac{(1 + a^2) \cos \theta - 2a}{u^2} = \frac{1}{a^2} \cos \theta + \frac{2}{a^3} \cos 2\theta + \frac{3}{a^4} \cos 3\theta + \dots, \dots \dots (4')$$

and equation (1') may be written,

$$\frac{(a^2 - 1)(1 - 2a \cos \theta + a^2)}{u^2} = 1 + \frac{2}{a} \cos \theta + \frac{2}{a^2} \cos 2\theta + \frac{2}{a^3} \cos 3\theta + \dots \dots \dots (5')$$

Multiply (4') and (5') by $2a(a^2 - 1)$ and $a^2 + 1$ respectively, and add, then $\frac{(a^2 - 1)^3}{u^2} = a^2 + 1 + 4a \cos \theta + \frac{2(3a^2 - 1)}{a^2} \cos 2\theta + \dots + \frac{2\{n(a^2 - 1) + (a^2 + 1)\}}{a^n} \cos n\theta + \dots$
etc.

1136. Successive Derivation of Further Series.

Again we have

$$\frac{d^2}{d\theta^2} \frac{1}{(A + B \cos \theta)^m} = \frac{d}{d\theta} \frac{mB \sin \theta}{(A + B \cos \theta)^{m+1}} = \frac{mB \cos \theta (A + B \cos \theta) + m(m+1)B^2(1 - (A + B \cos \theta)^2)}{(A + B \cos \theta)^{m+2}} = \frac{\lambda + \mu(A + B \cos \theta) + \nu(A + B \cos \theta)^2}{(A + B \cos \theta)^{m+2}}, \text{ say,}$$

where $\left. \begin{aligned} \lambda + \mu A + \nu A^2 &= m(m+1)B^2, \\ \mu B + 2\nu AB &= mA B, \\ \nu B^2 &= -m^2 B^2, \end{aligned} \right\} \text{ giving } \left. \begin{aligned} \lambda &= -m(m+1)(A^2 - B^2), \\ \mu &= m(2m+1)A, \\ \nu &= -m^2, \end{aligned} \right\}$

i.e. $\frac{m(m+1)(A^2 - B^2)}{u^{m+2}} - \frac{m(2m+1)A}{u^{m+1}} + \frac{m^2}{u^m} = -\frac{d^2}{d\theta^2} \frac{1}{u^m}$, where $u = A + B \cos \theta$.

Hence when series for $\frac{1}{u^m}$ and $\frac{1}{u^{m+1}}$ in terms of cosines of integral multiples of θ have been found, a series of the same kind can be deduced for $\frac{1}{u^{m+2}}$.

Thus, putting $A = 1 + a^2$ and $B = -2a$, we have

$$\frac{m(m+1)(1 - a^2)^2}{u^{m+2}} = \frac{m(2m+1)(1 + a^2)}{u^{m+1}} - \frac{m^3}{u^m} - \frac{d^2}{d\theta^2} \frac{1}{u^m} \dots \dots \dots (1)$$

Putting $m = 1$ and taking the case $a^2 < 1$,

$$\begin{aligned} \frac{1 \cdot 2(1 - a^2)^2}{u^3} &= \frac{1 \cdot 3(1 + a^2)}{u^2} - \frac{1}{u} - \frac{d^2}{d\theta^2} \left(\text{expansion of } \frac{1}{u} \right) \\ &= \frac{3(1 + a^2)}{(1 - a^2)^3} \left[(1 + a^2) + \sum_1^{\infty} 2a^n \{(n+1) - (n-1)a^2\} \cos n\theta \right] \\ &\quad - \frac{1}{1 - a^2} \left[1 + \sum_1^{\infty} 2a^n \cos n\theta \right] \\ &\quad + \frac{1}{1 - a^2} \left[\sum_1^{\infty} 2n^2 a^n \cos n\theta \right] \\ &= \frac{2(1 + 4a^2 + a^4)}{(1 - a^2)^3} + \sum_1^{\infty} 2a^n \left[\frac{3(1 + a^2)}{(1 - a^2)^3} \{(n+1) - (n-1)a^2\} + \frac{n^2 - 1}{1 - a^2} \right] \cos n\theta, \end{aligned}$$

i.e. $\frac{(1 - a^2)^6}{u^3} = (1 + 4a^2 + a^4) + \sum_1^{\infty} A_n \cos n\theta$,

where $A_n = a^n [(1 - a^2)^2 n^2 + 3(1 - a^4)n + 2(1 + 4a^2 + a^4)]$.

And further applications of the formula (1), viz. putting $m = 2, 3$, etc., will furnish successively the series for $\frac{1}{u^4}, \frac{1}{u^5}$, etc.; and similarly in the case when $a^2 > 1$.

1137. Moreover the differentiation of any one of these series furnishes another, e.g. $\frac{1}{u^{m-1}}$ furnishes the series for $\frac{\sin \theta}{u^m}$ in terms of series of sines of integral multiples of θ , as was seen in equation (3) of Art. 1135.

Thus, since

$$\frac{(1-a^2)^n}{u^2} = 1 + a^2 + \sum_1^\infty 2a^n [n(1-a^2) + (1+a^2)] \cos n\theta, \quad a^2 < 1,$$

or
$$\frac{(a^2-1)^n}{u^2} = a^2 + 1 + \sum_1^\infty \frac{2}{a^n} [n(a^2-1) + (a^2+1)] \cos n\theta, \quad a^2 > 1,$$

we have, by differentiating,

$$\frac{\sin \theta}{u^3} = \sum_1^\infty \frac{na^{n-1}}{2(1-a^2)^3} [n(1-a^2) + (1+a^2)] \sin n\theta, \quad a^2 < 1,$$

or
$$= \sum_1^\infty \frac{n}{2(a^2-1)^3} \cdot \frac{1}{a^{n+1}} [n(a^2-1) + (a^2+1)] \sin n\theta, \quad a^2 > 1,$$

and so on.

Again a series for $\frac{\cos \theta}{u^m}$ may be found in terms of the series for $\frac{1}{u^m}$ and $\frac{1}{u^{m-1}}$.

For
$$\frac{\cos \theta}{u^m} = \frac{1}{2a} \frac{1+a^2-u}{u^{m-1}} = \frac{1+a^2}{2a} \cdot \frac{1}{u^m} - \frac{1}{2a} \frac{1}{u^{m-1}}.$$

1138. Other powers of $\sin \theta$ or $\cos \theta$ in the numerator may be readily arranged for.

Thus, since $\frac{\sin \theta}{u^2} = \frac{1}{1-a^2} \sum_1^\infty na^{n-1} \sin n\theta$, ($a^2 < 1$), we have

$$\begin{aligned} \frac{\sin^2 \theta}{u^2} &= \frac{1}{2(1-a^2)} \sum_1^\infty na^{n-1} 2 \sin \theta \sin n\theta \\ &= \frac{1}{2(1-a^2)} \sum_1^\infty na^{n-1} \{ \cos (n-1)\theta - \cos (n+1)\theta \} \\ &= \frac{1}{2} \frac{1}{1-a^2} [1 + 2a \cos \theta + (3a^2-1) \cos 2\theta + (4a^3-2a) \cos 3\theta \\ &\quad + (5a^4-3a^2) \cos 4\theta + \dots], \quad a^2 < 1. \end{aligned}$$

And if $a^2 > 1$, a similar result may be obtained. These results are mainly interesting from the definite integrals which may be obtained from them by the aid of the results of Art. 1121; and to this matter we now turn.

1139. Definite Integrals immediately derivable.

By the application of the rules of Art. 1121 to the series of Art. 1134, we have at once the following definite integrals. Put $1-2a \cos \theta + a^2 \equiv u$, and consider in each case n to be a positive integer.

$$\left. \begin{array}{l} (1) \int_0^\pi \frac{d\theta}{u} = \frac{\pi}{1-a^2} \\ (2) \int_0^\pi \frac{\cos n\theta}{u} d\theta = \frac{\pi}{1-a^2} a^n \end{array} \right\} a^2 < 1$$

$$\left. \begin{array}{l} (1') \int_0^\pi \frac{d\theta}{u} = \frac{\pi}{a^2-1} \\ (2') \int_0^\pi \frac{\cos n\theta}{u} d\theta = \frac{\pi}{a^2-1} \frac{1}{a^n} \end{array} \right\} a^2 > 1$$

} from Series I.

$$\begin{aligned}
 (3) \int_0^\pi \frac{\sin^2 \theta}{u} d\theta &= \frac{\pi}{2} \\
 (4) \int_0^\pi \frac{\sin \theta \sin n\theta}{u} d\theta &= \frac{\pi}{2} a^{n-1} \left. \vphantom{\int_0^\pi} \right\} a^2 < 1 \\
 (3') \int_0^\pi \frac{\sin^2 \theta}{u} &= \frac{\pi}{2a^2} \left. \vphantom{\int_0^\pi} \right\} a^2 > 1 \\
 (4') \int_0^\pi \frac{\sin \theta \sin n\theta}{u} &= \frac{\pi}{2} \frac{1}{a^{n+1}} \left. \vphantom{\int_0^\pi} \right\} \\
 & \left. \vphantom{\int_0^\pi} \right\} \text{from Series 2.}
 \end{aligned}$$

$$\begin{aligned}
 (5) \int_0^\pi \frac{1 - a \cos \theta}{u} d\theta &= \pi \\
 (6) \int_0^\pi \frac{(1 - a \cos \theta) \cos n\theta}{u} d\theta &= \frac{\pi}{2} a^n \quad (n > 0) \left. \vphantom{\int_0^\pi} \right\} a^2 < 1 \\
 (5') \int_0^\pi \frac{1 - a \cos \theta}{u} d\theta &= 0 \\
 (6') \int_0^\pi \frac{(1 - a \cos \theta) \cos n\theta}{u} d\theta &= -\frac{\pi}{2} \cdot \frac{1}{a^n} \quad (n > 0) \left. \vphantom{\int_0^\pi} \right\} a^2 > 1 \\
 & \left. \vphantom{\int_0^\pi} \right\} \text{from Series 3.}
 \end{aligned}$$

$$\begin{aligned}
 (7) \int_0^\pi \frac{\cos \theta}{u} d\theta &= \frac{\pi a}{1 - a^2} \\
 (8) \int_0^\pi \frac{\cos \theta \cos n\theta}{u} d\theta &= \frac{\pi}{2} \frac{1 + a^2}{1 - a^2} a^{n-1} \quad (n > 0) \left. \vphantom{\int_0^\pi} \right\} a^2 < 1 \\
 (7') \int_0^\pi \frac{\cos \theta}{u} d\theta &= \frac{\pi}{a^2 - 1} \cdot \frac{1}{a} \\
 (8') \int_0^\pi \frac{\cos \theta \cos n\theta}{u} d\theta &= \frac{\pi}{2} \frac{a^2 + 1}{a^2 - 1} \frac{1}{a^{n+1}} \quad (n > 0) \left. \vphantom{\int_0^\pi} \right\} a^2 < 1 \\
 & \left. \vphantom{\int_0^\pi} \right\} \text{from Series 4}
 \end{aligned}$$

$$\begin{aligned}
 (9) \int_0^\pi \log u d\theta &= 0^* \\
 (10) \int_0^\pi \cos n\theta \log u d\theta &= -\frac{\pi}{n} a^{n+1} \left. \vphantom{\int_0^\pi} \right\} a^2 < 1 \\
 (9') \int_0^\pi \log u d\theta &= \pi \log a^{2*} \\
 (10') \int_0^\pi \cos n\theta \log u d\theta &= -\frac{\pi}{n} \frac{1}{a^n} \left. \vphantom{\int_0^\pi} \right\} a^2 > 1 \\
 & \left. \vphantom{\int_0^\pi} \right\} \text{from Series 5.}
 \end{aligned}$$

$$(11) \int_0^\pi \log u d\theta = 0^*, \text{ when } a = 1, \text{ from Series 9.}$$

$$\begin{aligned}
 (12) \int_0^\pi \sin n\theta \tan^{-1} \frac{a \sin \theta}{1 - a \cos \theta} d\theta &= \frac{\pi}{2n} a^n, \quad a^2 < 1 \\
 (13) \int_0^\pi \sin n\theta \tan^{-1} \frac{\sin \theta}{a - \cos \theta} d\theta &= \frac{\pi}{2n} \frac{1}{a^n}, \quad a^2 > 1 \left. \vphantom{\int_0^\pi} \right\} \text{from Series 6.}
 \end{aligned}$$

* Poisson, *Journal de l'École Polytechnique*, xvii.† Legendre, *Exercices*, vol. ii., p. 123.

$$(14) \int_0^\pi \cos n\theta \log\left(2 \cos \frac{\theta}{2}\right) d\theta = (-1)^{n-1} \frac{\pi}{2n}, \text{ from Series 7.}$$

$$(15) \int_0^\pi \cos n\theta \log\left(2 \sin \frac{\theta}{2}\right) d\theta = -\frac{\pi}{2n}, \text{ from Series 8.}$$

ILLUSTRATIVE EXAMPLES.

1140. Denoting $1 - 2a \cos \theta + a^2$ by u :

1. Deduce from $\int_0^\pi \log u d\theta = 0$ or $\pi \log a^2$, as a^2 is $<$ or $>$ 1, by integration by parts,

$$\int_0^\pi \frac{\theta \sin \theta}{u} d\theta = \frac{\pi}{2a} \log(1+a^2) \quad (a^2 < 1)$$

or
$$= \frac{\pi}{2a} \log\left(1 + \frac{1}{a}\right)^2 \quad (a^2 < 1).$$

2. Deduce from Series 3 and 3', Art. 1135,

$$\int_0^\pi \frac{\sin \theta}{u^2} d\theta = \frac{2}{(1-a^2)^2}, \quad (a^2 < 1), \text{ or } \frac{2}{(a^2-1)^2}, \quad (a^2 > 1).$$

3. Show by direct integration that

$$\int_0^\pi \frac{\sin \theta}{u^n} d\theta = \frac{1}{2a(n-1)} \left\{ \frac{1}{(a-1)^{2(n-1)}} - \frac{1}{(a+1)^{2(n+1)}} \right\} \quad (n \neq 1),$$

$$\int_0^\pi \frac{\sin \theta}{u} d\theta = \frac{1}{a} \log \frac{1+a}{1-a} \quad (a^2 < 1)$$

or
$$= \frac{1}{a} \log \frac{a+1}{a-1} \quad (a^2 > 1).$$

4. Prove that
$$\int_0^\pi \frac{\sin \theta \sin n\theta}{u^2} d\theta = \frac{n\pi}{2} \frac{a^{n-1}}{1-a^2} \quad (a^2 < 1).$$

or
$$= \frac{n\pi}{2} \frac{a^{-n-1}}{a^2-1} \quad (a^2 > 1).$$

5. Prove that
$$\int_0^\pi \frac{d\theta}{u^3} = \pi \frac{1+4a^2+a^4}{(1-a^2)^3} \quad (a^2 < 1).$$

6. Prove that

$$\int_0^\pi \frac{\cos n\theta}{u^3} d\theta = \frac{\pi}{2} \frac{a^n}{(1-a^2)^3} \{ (1-a^2)^2 n^2 + 3(1-a^4)n + 2(1+4a^2+a^4) \} \quad (a^2 < 1).$$

7. From the formulae of Art. 1137, deduce

$$\int_0^\pi \frac{\sin^2 \theta}{u^3} d\theta = \frac{\pi}{2} \frac{1}{(1-a^2)^3} \quad (a^2 < 1)$$

or
$$= \frac{\pi}{2} \frac{1}{(a^2-1)^3} \quad (a^2 > 1).$$

$$\int_0^\pi \frac{\sin \theta \sin n\theta}{u^3} d\theta = \frac{\pi}{4} \frac{na^{n-1}}{(1-a^2)^3} [n(1-a^2) + (1+a^2)] \quad (a^2 < 1)$$

or
$$= \frac{\pi}{4} \frac{na^{-n-1}}{(a^2-1)^3} [n(a^2-1) + (a^2+1)] \quad (a^2 > 1).$$

1141. **Series for Evaluation when the Integral is not expressible in Finite Terms.**

Again we may obtain the values of many definite integrals of this class in the form of series which, though they may not be capable of summation, will nevertheless serve for their numerical calculation.

$$\begin{aligned} \text{For instance, } \int_0^\pi \sin 2\theta \log(1 - 2a \cos \theta + a^2) d\theta \quad (a^2 < 1) \\ &= -2 \int_0^\pi \sin 2\theta \left(a \cos \theta + \frac{1}{2} a^2 \cos 2\theta + \frac{1}{3} a^3 \cos 3\theta + \dots \right) d\theta \\ &= -2 \left[\frac{4a}{2^2 - 1^2} + \frac{1}{3} \cdot \frac{4a^3}{2^2 - 3^2} + \frac{1}{5} \cdot \frac{4a^5}{2^2 - 5^2} + \dots \right] \\ &= 8 \left[\frac{a}{(-1)1 \cdot 3} + \frac{a^3}{1 \cdot 3 \cdot 5} + \frac{a^5}{3 \cdot 5 \cdot 7} + \frac{a^7}{5 \cdot 7 \cdot 9} + \frac{a^9}{7 \cdot 9 \cdot 11} + \dots \right]. \end{aligned}$$

1142. Again, since $\sin(p+1)\theta - \sin(p-1)\theta = 2 \sin \theta \cos p\theta$ we have

$$\int_0^\pi \frac{\sin(p+1)\theta}{\sin \theta} d\theta - \int_0^\pi \frac{\sin(p-1)\theta}{\sin \theta} d\theta = 2 \int_0^\pi \cos p\theta d\theta = 0,$$

when p is integral.

That is, putting $u_p = \int_0^\pi \frac{\sin p\theta}{\sin \theta} d\theta$, we have

$$u_{p+1} = u_{p-1} = u_{p-3} = \text{etc.},$$

$$\text{and } u_1 = \int_0^\pi \frac{\sin \theta}{\sin \theta} d\theta = \pi, \quad u_2 = \int_0^\pi \frac{\sin 2\theta}{\sin \theta} d\theta = \int_0^\pi 2 \cos \theta d\theta = 0;$$

$$\therefore u_{2n} = 0, \quad u_{2n+1} = \pi.$$

Again, p and q being integral,

$$\begin{aligned} \int_0^\pi \frac{\sin p\theta}{\sin \theta} \cos q\theta d\theta &= \frac{1}{2} \int_0^\pi \frac{\sin(p+q)\theta + \sin(p-q)\theta}{\sin \theta} d\theta \\ &= 0 \text{ if } p+q \text{ be even, or if } p+q \text{ be odd and } p < q, \\ &= \pi \text{ if } p+q \text{ be odd and } p > q. \end{aligned}$$

Hence if $F(\theta)$ be a function capable of convergent expansion as a series of cosines of multiples of θ , say

$$F(\theta) = A_0 + A_1 \cos \theta + A_2 \cos 2\theta + \dots + A_r \cos r\theta + \dots,$$

$$\int_0^\pi \frac{\sin 2p\theta}{\sin \theta} F(\theta) d\theta = (A_1 + A_3 + \dots + A_{2p-1})\pi$$

$$\text{and } \int_0^\pi \frac{\sin(2p+1)\theta}{\sin \theta} F(\theta) d\theta = (A_0 + A_2 + A_4 + \dots + A_{2p})\pi.$$

ILLUSTRATIVE EXAMPLES.

1143. 1. Thus, since

$$\cos^{2n} \theta = \frac{1}{2^{2n-1}} \left[\frac{1}{2} {}^{2n}C_n + {}^{2n}C_{n+1} \cos 2\theta + {}^{2n}C_{n+2} \cos 4\theta + \dots + {}^{2n}C_{2n} \cos 2n\theta \right],$$

we have, if $p > n$,

$$\begin{aligned} \int_0^\pi \frac{\sin(2p+1)\theta}{\sin \theta} \cos^{2n} \theta \, d\theta &= \frac{\pi}{2^{2n-1}} \left[\frac{1}{2} {}^{2n}C_n + {}^{2n}C_{n+1} + \dots + {}^{2n}C_{2n} \right] \\ &= \frac{\pi}{2^{2n}} \left[{}^{2n}C_0 + {}^{2n}C_1 + \dots + {}^{2n}C_{2n} \right] = \frac{\pi}{2^{2n}} (1+1)^{2n} = \pi, \end{aligned}$$

whilst, if $p < n$,

$$\int_0^\pi \frac{\sin(2p+1)\theta}{\sin \theta} \cos^{2n} \theta \, d\theta = \frac{\pi}{2^{2n-1}} \left[\frac{1}{2} {}^{2n}C_n + {}^{2n}C_{n+1} + \dots + {}^{2n}C_{n+p} \right] = \frac{\pi}{2^{2n}} \sum_{r=n-p}^{r=n+p} {}^{2n}C_r.$$

2. Apply Art. 1142 to show that, if $u \equiv 1 - 2a \cos \theta + a^2$,

$$\int_0^\pi \frac{\sin 2n\theta}{\sin \theta} \frac{\cos \theta}{u} \cdot d\theta = \pi \frac{1+a^2}{1-a^2} \cdot \frac{1-a^{2n}}{1-a^2} \quad (a^2 < 1).$$

3. Prove that

$$\int_0^\pi \frac{\sin 2n\theta}{\sin \theta} \log u \, d\theta = -2\pi \left\{ \frac{a}{1} + \frac{a^3}{3} + \frac{a^5}{5} + \dots + \frac{a^{2n-1}}{2n-1} \right\} \quad (a^2 < 1).$$

1144. A Reduction Formula.

Let $u \equiv 1 - 2a \cos \theta + a^2$.

We have seen that

$$I_1 \equiv \int_0^\pi \frac{\cos p\theta}{u} \, d\theta = \frac{\pi a^p}{1-a^2} \quad (a^2 < 1) \quad \text{and} \quad \frac{\pi a^{-p}}{a^2-1} \quad (a^2 > 1),$$

p being a positive integer.

$$\text{Let} \quad I_n = \int_0^\pi \frac{\cos p\theta}{u^n} \, d\theta.$$

$$\begin{aligned} \text{Then} \quad \frac{dI_n}{da} &= 2n \int_0^\pi \frac{\cos p\theta}{u^{n+1}} (\cos \theta - a) \, d\theta \\ &= n \int_0^\pi \frac{\cos p\theta}{u^{n+1}} \frac{1-a^2-u}{a} \, d\theta = n \frac{1-a^2}{a} I_{n+1} - \frac{n}{a} I_n; \end{aligned}$$

$$\therefore I_{n+1} = \frac{1}{1-a^2} \left(I_n + \frac{a}{n} \frac{dI_n}{da} \right), \quad \text{i.e.} \quad I_{n+1} = \frac{1}{1-a^2} \frac{d}{da^n} (a^n I_n), \dots (1)$$

an equation by means of which the successive values of I_2, I_3, I_4 , etc., may be deduced.

1145. We have

$$\begin{aligned} I_2 &= \frac{1}{1-a^2} \frac{d}{da} (aI_1) = \frac{\pi}{1-a^2} \frac{d}{da} \frac{a^{p+1}}{1-a^2} \\ &= \frac{\pi a^p}{(1-a^2)^2} K_2, \quad \text{where} \quad K_2 = (p+1) - (p-1)a^2, \end{aligned}$$

$I_3 = \frac{1}{1-a^2} \frac{d}{da^2} (a^2 I_2)$, which after a little reduction takes the form $\frac{1}{2!} \frac{\pi a^p}{(1-a^2)^5} K_3$, where $K_3 = (p+1)(p+2) - 2(p+2)(p-2)a^2 + (p-2)(p-1)a^4$,

$I_4 = \frac{1}{1-a^2} \frac{d}{da^3} (a^3 I_3)$, which after reduction becomes $\frac{1}{3!} \frac{\pi a^p}{(1-a^2)^7} K_4$, where $K_4 = (p+1)(p+2)(p+3) - 3(p+2)(p+3)(p-3)a^2 + 3(p+3)(p-3)(p-2)a^4 - (p-3)(p-2)(p-1)a^6$,

and so on, the law of formation of the successive values of K_n being obvious, and it may be verified inductively by substitution in Equation (1) that the general form of the result is

$$I_n = \frac{\pi a^p}{(1-a^2)^{2n-1}} {}^{n+p-1}C_p \left[1 + {}^{n-1}C_1 \frac{n-1-p}{1+p} a^2 + {}^{n-1}C_2 \frac{(n-1-p)(n-2-p)}{(1+p)(2+p)} a^4 + {}^{n-1}C_3 \frac{(n-1-p)(n-2-p)(n-3-p)}{(1+p)(2+p)(3+p)} a^6 + \dots \right],$$

a form due to Legendre (*Exercices*, p. 374).

If we replace ${}^{n+p-1}C_p$ by its equivalent $\frac{(p+1)(p+2)\dots(p+n-1)}{1 \cdot 2 \cdot 3 \dots (n-1)}$ the same formula, with the sign changed and $-p$ written for p , will suffice for the calculation of the corresponding integrals in the case when $a^2 > 1$.

1146. As particular cases we have, if $a^2 < 1$,

$$\int_0^\pi \frac{\cos p\theta}{u^2} d\theta = \frac{\pi a^p}{(1-a^2)^3} (p+1) \left[1 + \frac{1-p}{1+p} a^2 \right] = \frac{\pi a^p}{(1-a^2)^3} [(p+1) - (p-1)a^2],$$

$$\int_0^\pi \frac{\cos p\theta}{u^3} d\theta = \frac{\pi a^p}{(1-a^2)^5} \frac{(p+2)(p+1)}{1 \cdot 2} \left[1 + 2 \frac{2-p}{1+p} a^2 + \frac{(2-p)(1-p)}{(1+p)(2+p)} a^4 \right]$$

$$= \frac{1}{2!} \frac{\pi a^p}{(1-a^2)^5} [(p+1)(p+2) - 2(p+2)(p-2)a^2 + (p-2)(p-1)a^4],$$

etc. ;

and if $a^2 > 1$,

$$\int_0^\pi \frac{\cos p\theta}{u^2} d\theta = \frac{\pi a^{-p}}{(a^2-1)^3} [(1-p) + (1+p)a^2],$$

$$\int_0^\pi \frac{\cos p\theta}{u^3} d\theta = \frac{1}{2!} \frac{\pi a^{-p}}{(a^2-1)^5} [(1-p)(2-p) + 2(2-p)(2+p)a^2 + (2+p)(1+p)a^4],$$

etc.

1147. Some Special Cases.

The special cases when $p=0$ and $p=n-1$ are interesting.

If $p=0$,

$$\int_0^\pi \frac{d\theta}{u^n} = \frac{\pi}{(1-a^2)^{2n-1}} [1 + {}^{n-1}C_1^2 a^2 + {}^{n-1}C_2^2 a^4 + {}^{n-1}C_3^2 a^6 + \dots],$$

the several coefficients being the squares of those of the binomial expansion of $(1+z)^{n-1}$.

Thus

$$\int_0^\pi \frac{d\theta}{u} = \frac{\pi}{1-a^2},$$

$$\int_0^\pi \frac{d\theta}{u^2} = \frac{\pi}{(1-a^2)^3}(1+a^2),$$

$$\int_0^\pi \frac{d\theta}{u^3} = \frac{\pi}{(1-a^2)^5}(1+2^2a^2+a^4),$$

$$\int_0^\pi \frac{d\theta}{u^4} = \frac{\pi}{(1-a^2)^7}(1+3^2a^2+3^2a^4+a^6),$$

$$\int_0^\pi \frac{d\theta}{u^5} = \frac{\pi}{(1-a^2)^9}(1+4^2a^2+6^2a^4+4^2a^6+a^8),$$

etc.

If $p = n - 1$, we have

$$\int_0^\pi \frac{\cos(n-1)\theta}{u^n} d\theta = \frac{\pi a^{n-1}}{(1-a^2)^{2n-1}} {}^{2n-2}C_{n-1}.$$

Cases where $a^2 > 1$. Take for instance $I_2 = \int_0^\pi \frac{d\theta}{u^2}$.

Here $p = 0$ and $I_2 = -\frac{\pi}{(1-a^2)^3}(1+a^2) = \frac{\pi}{(a^2-1)^3}(1+a^2)$.

Again, $I_3 = \int_0^\pi \frac{d\theta}{u^3} = \frac{\pi}{(a^2-1)^5}(1+2^2a^2+a^4)$, etc. ;

and it will appear generally that in the case of $p = 0$, the only change necessary in the previous results will be to replace $1 - a^2$ by $a^2 - 1$.

1148. Extension of the Reduction Formula.

It may be remarked that any integral of the form

$$I_n = \int_0^\pi \frac{F(\theta)}{u^n} d\theta$$

is subject to the same reduction formula as that used in the last article, viz.

$$I_{n+1} = \frac{1}{1-a^2} \frac{d}{da^n} (a^n I_n).$$

For $\frac{dI_n}{da} = 2n \int_0^\pi \frac{F(\theta)}{u^{n+1}} (\cos \theta - a) d\theta = n \int_0^\pi \frac{F(\theta)}{u^{n+1}} \frac{1-a^2-u}{a} d\theta$

$$= n \frac{1-a^2}{a} I_{n+1} - \frac{n}{a} I_n,$$

giving, as before, $I_{n+1} = \frac{1}{1-a^2} \frac{d}{da^n} (a^n I_n)$.

Hence in all such cases, if I_1 can be obtained in finite terms, so also can all the rest of the group I_2, I_3, I_4 , etc.

1149. We shall show for instance that this is the case with the class of integrals

$$I_n = \int_0^\pi \frac{\sin p\theta}{u^n} d\theta, \quad p \text{ being a positive integer.}$$

To do this it is only necessary to show that I_1 is expressible in finite terms, and we shall find that

$$\frac{1-a^2}{2} \int_0^\pi \frac{\sin p\theta}{u} d\theta = \frac{a^{p-1} - a^{-(p-1)}}{1} + \frac{a^{p-3} - a^{-(p-3)}}{3} + \frac{a^{p-5} - a^{-(p-5)}}{5} + \dots$$

to $\frac{p}{2}$ or $\frac{p+1}{2}$ terms $- (a^p - a^{-p}) \tanh^{-1} a \dots (1), (a^2 < 1) \dots (1).$

Take the case p odd $= 2\lambda + 1$, say,

$$\begin{aligned} \frac{1-a^2}{2} \int_0^\pi \frac{\sin(2\lambda+1)\theta}{u} d\theta &= \int_0^\pi \sin(2\lambda+1)\theta \left[\frac{1}{2} + a \cos \theta + a^2 \cos 2\theta + \dots \right] d\theta \\ &= \frac{1}{2\lambda+1} + 2(2\lambda+1) \left[\frac{a^2}{(2\lambda+1)^2 - 2^2} + \frac{a^4}{(2\lambda+1)^2 - 4^2} + \dots + \frac{a^{2\lambda}}{(2\lambda+1)^2 - (2\lambda)^2} \right] \\ &\quad - 2(2\lambda+1) \left[\frac{a^{2\lambda+2}}{(2\lambda+2)^2 - (2\lambda+1)^2} + \frac{a^{2\lambda+4}}{(2\lambda+4)^2 - (2\lambda+1)^2} + \dots \text{ad inf.} \right] \\ &= \frac{1}{2\lambda+1} - \left[a^2 \left(\frac{1}{1-2\lambda} - \frac{1}{3+2\lambda} \right) + a^4 \left(\frac{1}{3-2\lambda} - \frac{1}{5+2\lambda} \right) + \dots + a^{2\lambda} \left(\frac{1}{-1} - \frac{1}{4\lambda+1} \right) \right] \\ &\quad - \left[a^{2\lambda+2} \left(\frac{1}{1} - \frac{1}{4\lambda+3} \right) + a^{2\lambda+4} \left(\frac{1}{3} - \frac{1}{4\lambda+5} \right) + \dots \text{ad inf.} \right] \\ &= \frac{a^{2\lambda}}{1} + \frac{a^{2\lambda-2}}{3} + \dots + \frac{a^2}{2\lambda-1} + \frac{1}{2\lambda+1} + \frac{a^2}{2\lambda+3} + \dots + \frac{a^{2\lambda}}{4\lambda+1} \\ &\quad - \left[a^{2\lambda+1} \tanh^{-1} a - \frac{1}{a^{2\lambda+1}} \left(\tanh^{-1} a - \frac{a^1}{1} - \frac{a^3}{3} - \dots - \frac{a^{2\lambda-1}}{2\lambda-1} - \frac{a^{2\lambda+1}}{2\lambda+1} - \dots - \frac{a^{4\lambda+1}}{4\lambda+1} \right) \right], \\ \text{i.e. } \frac{1-a^2}{2} \int_0^\pi \frac{\sin(2\lambda+1)\theta}{u} d\theta &= \frac{a^{2\lambda} - a^{-2\lambda}}{1} + \frac{a^{2\lambda-2} - a^{-(2\lambda-2)}}{3} + \dots \\ &\quad + \frac{a^2 - a^{-2}}{2\lambda-1} - \{ a^{2\lambda+1} - a^{-(2\lambda+1)} \} \tanh^{-1} a. \end{aligned}$$

And in exactly the same way, if p be even $= 2\lambda$,

$$\frac{1-a^2}{2} \int_0^\pi \frac{\sin 2\lambda\theta}{u} d\theta = \frac{a^{2\lambda-1} - a^{-(2\lambda-1)}}{1} + \frac{a^{2\lambda-3} - a^{-(2\lambda-3)}}{3} + \dots + \frac{a - a^{-1}}{2\lambda-1} - \{ a^{2\lambda} - a^{-2\lambda} \} \tanh^{-1} a \quad (a^2 < 1),$$

which establishes the result stated.

If we write $a = e^{-\gamma}$ we may exhibit the result as

$$\int_0^\pi \frac{\sin p\theta}{u} d\theta = 2 \frac{\sinh p\gamma}{\sinh \gamma} \frac{\tanh^{-1} a}{a} - \frac{2}{a} \operatorname{cosech} \gamma \left[\frac{\sinh(p-1)\gamma}{1} + \frac{\sinh(p-3)\gamma}{3} + \dots \right]$$

to $\frac{p}{2}$ or $\frac{p+1}{2}$ terms],

according as p is even or odd.

1150. Particular Cases.

The particular cases when $p=1, 2, 3$, etc., are

$$\int_0^{\pi} \frac{\sin \theta}{u} d\theta = -\frac{2}{1-a^2} \left(a - \frac{1}{a} \right) \tanh^{-1} a = \frac{2}{a} \tanh^{-1} a,$$

$$\int_0^{\pi} \frac{\sin 2\theta}{u} d\theta = \frac{2}{1-a^2} \left[\left(a - \frac{1}{a} \right) - \left(a^2 - \frac{1}{a^2} \right) \tanh^{-1} a \right] = 2 \frac{1+a^2}{a^2} \tanh^{-1} a - \frac{2}{a},$$

$$\int_0^{\pi} \frac{\sin 3\theta}{u} d\theta = \frac{2}{1-a^2} \left[\left(a^2 - \frac{1}{a^2} \right) - \left(a^3 - \frac{1}{a^3} \right) \tanh^{-1} a \right] = 2 \frac{1+a^2+a^4}{a^3} \tanh^{-1} a - 2 \frac{1+a^2}{a^2},$$

etc.

1151. General Conclusion derived.

It appears then that $\int_0^{\pi} \frac{\sin p\theta}{u} d\theta$ is in all cases, when p is a positive integer and $a^2 < 1$, of the form

$$P + Q \tanh^{-1} a,$$

where P and Q are known algebraical functions of a .

And in any such case the reduction formula

$$I_{n+1} = \frac{1}{1-a^2} \frac{d}{da^n} (a^n I_n)$$

may be used to determine I_1, I_2, I_3 , etc.

It will be observed that the first case of this result follows at once from the series for $\frac{\sin \theta}{u}$ (No. 2 of Art. 1134).

$$\begin{aligned} \text{For } \int_0^{\pi} \frac{\sin \theta}{u} d\theta &= \int_0^{\pi} (\sin \theta + a \sin 2\theta + a^2 \sin 3\theta + \dots) d\theta \quad (a^2 < 1) \\ &= 2 \left(1 + \frac{a^2}{3} + \frac{a^4}{5} + \dots \right) = \frac{2}{a} \tanh^{-1} a. \end{aligned}$$

If a^2 be > 1 ,

$$\begin{aligned} \int_0^{\pi} \frac{\sin \theta}{u} d\theta &= \int_0^{\pi} \left(\frac{1}{a^2} \sin \theta + \frac{1}{a^3} \sin 2\theta + \frac{1}{a^4} \sin 3\theta + \dots \right) d\theta \\ &= 2 \left(\frac{1}{a^2} + \frac{1}{3} \frac{1}{a^4} + \frac{1}{5} \frac{1}{a^6} + \dots \right) \\ &= \frac{2}{a} \tanh^{-1} \frac{1}{a} = \frac{2}{a} \coth^{-1} a. \end{aligned}$$

The general case when $a^2 > 1$ for $\int_0^{\pi} \frac{\sin p\theta}{u} d\theta$ may be investigated as in the case $a^2 < 1$, using the series

$$\frac{a^2 - 1}{1 - 2a \cos \theta + a^2} = 1 + \frac{2}{a} \cos \theta + \frac{2}{a^2} \cos 2\theta + \dots,$$

and it will be clear that all that will be necessary to modify equation (1) of Art. 1149 will be to replace $1 - a^2$ by $a^2 - 1$ on the left-hand side and a by a^{-1} on the right, which leaves the formula for $\int_0^{\pi} \frac{\sin p\theta}{u} d\theta$ unchanged, except that $\tanh^{-1} a$ will be replaced by $\coth^{-1} a$.

Thus, in all cases whether $a^2 >$ or $<$ 1, and p a positive integer, we have

$$\frac{1-a^2}{2} \int_0^\pi \frac{\sin p\theta}{u} d\theta = \frac{a^{p-1} - a^{-(p-1)}}{1} + \frac{a^{p-3} - a^{-(p-3)}}{3} + \dots$$

to $\frac{p}{2}$ or $\frac{p+1}{2}$ terms $-(a^p - a^{-p})X$,

where $X = \tanh^{-1}a$ or $\coth^{-1}a$, according as $a^2 <$ or $>$ 1.

1152. General Formulae.

Let the expressions $\int_0^\pi \frac{\cos p\theta}{u^n} d\theta$ and $\int_0^\pi \frac{\sin p\theta}{u^n} d\theta$ be respectively called $C(p, n)$ and $S(p, n)$.

Then

$$\int_0^\pi \frac{\cos p\theta \cos q\theta}{u^n} d\theta = \frac{1}{2} \int_0^\pi \frac{\cos(p+q)\theta + \cos(p-q)\theta}{u^n} d\theta = \frac{1}{2} [C(p+q, n) + C(p-q, n)],$$

$$\int_0^\pi \frac{\sin p\theta \sin q\theta}{u^n} d\theta = \frac{1}{2} \int_0^\pi \frac{-\cos(p+q)\theta + \cos(p-q)\theta}{u^n} d\theta = \frac{1}{2} [-C(p+q, n) + C(p-q, n)],$$

$$\int_0^\pi \frac{\cos p\theta \sin q\theta}{u^n} d\theta = \frac{1}{2} \int_0^\pi \frac{\sin(p+q)\theta - \sin(p-q)\theta}{u^n} d\theta = \frac{1}{2} [S(p+q, n) - S(p-q, n)],$$

$$\int_0^\pi \frac{\sin p\theta \cos q\theta}{u^n} d\theta = \frac{1}{2} \int_0^\pi \frac{\sin(p+q)\theta + \sin(p-q)\theta}{u^n} d\theta = \frac{1}{2} [S(p+q, n) + S(p-q, n)].$$

Hence all such integrals can be computed, p, q and n being positive integers.

1153. Integrals of the Class $\int_0^\pi u^n \cos p\theta d\theta$ (Legendre, *Exercices*, p. 375), n a positive integer.

We have

$$\begin{aligned} u^n &= (1 - 2a \cos \theta + a^2)^n = (1 - ae^{i\theta})^n (1 - ae^{-i\theta})^n \\ &= (K_0 + K_1 e^{i\theta} + K_2 e^{2i\theta} + \dots)(K_0 + K_1 e^{-i\theta} + K_2 e^{-2i\theta} + \dots), \end{aligned}$$

where $K_p = (-1)^p a^p \frac{n(n-1)\dots(n-p+1)}{1 \cdot 2 \dots p}$ and $K_0 = 1$.

The coefficients of $e^{p i\theta}$ and $e^{-p i\theta}$ in the product are each

$$K_p K_0 + K_{p+1} K_1 + K_{p+2} K_2 + K_{p+3} K_3 + \dots,$$

giving rise to the term

$$(K_p K_0 + K_{p+1} K_1 + K_{p+2} K_2 + \dots) 2 \cos p\theta,$$

and in the integration this is the only term we shall require, for all the others vanish by virtue of the theorem of Art. 1121.

Hence $I \equiv \int_0^\pi u^n \cos p\theta d\theta = \pi (K_p K_0 + K_{p+1} K_1 + K_{p+2} K_2 + \dots)$.

Now $\frac{K_{p+1}}{K_p} = -a \frac{n-p}{p+1}$, $\frac{K_{p+2}}{K_p} = a^2 \frac{(n-p)(n-p-1)}{(p+1)(p+2)}$, etc.,

and $K_1 = -\frac{n}{1}a$, $K_2 = \frac{n(n-1)}{1 \cdot 2}a^2$, etc.;

$$\therefore I = (-1)^p \pi a^p \frac{n(n-1) \dots (n-p+1)}{1 \cdot 2 \dots p} \left[1 + \frac{n}{1} \cdot \frac{n-p}{p+1} a^2 + \frac{n(n-1)}{1 \cdot 2} \cdot \frac{(n-p)(n-p-1)}{(p+1)(p+2)} a^4 + \dots \right].$$

1154. The Particular Case $p=0$ gives

$$I = \pi (K_0^2 + K_1^2 + K_2^2 + K_3^2 + \dots),$$

i.e. $\int_0^\pi u^n d\theta = \pi (1 + {}^n C_1^2 a^2 + {}^n C_2^2 a^4 + {}^n C_3^2 a^6 + \dots)$.

We have seen (Art. 1147) that

$$\int_0^\pi \frac{d\theta}{u^{n+1}} = \frac{\pi}{(1-a^2)^{2n+1}} (1 + {}^n C_1^2 a^2 + {}^n C_2^2 a^4 + {}^n C_3^2 a^6 + \dots);$$

whence it follows that

$$\int_0^\pi u^n d\theta = (1-a^2)^{2n+1} \int_0^\pi \frac{d\theta}{u^{n+1}} \quad (\text{see Art. 1155}); \dots\dots\dots(1)$$

and more generally, since

$$\int_0^\pi \frac{\cos p\theta d\theta}{u^{n+1}} = \frac{\pi a^p}{(1-a^2)^{2n+1}} \frac{(p+1)(p+2) \dots (p+n)}{1 \cdot 2 \cdot 3 \dots n} \times \left(1 + \frac{n}{1} \cdot \frac{n-p}{p+1} a^2 + \frac{n(n-1)}{1 \cdot 2} \cdot \frac{(n-p)(n-p-1)}{(p+1)(p+2)} a^4 + \dots \right),$$

by writing $n+1$ for n in the formula of Art. 1145, we have, by comparison with the result proved above for $\int_0^\pi u^n \cos p\theta d\theta$,

$$\int_0^\pi \frac{\cos p\theta}{u^{n+1}} d\theta = \frac{(-1)^p}{(1-a^2)^{2n+1}} \frac{(n+1)(n+2) \dots (n+p)}{n(n-1) \dots (n-p+1)} \int_0^\pi u^n \cos p\theta d\theta,$$

or

$$\int_0^\pi u^n \cos p\theta d\theta = (-1)^p (1-a^2)^{2n+1} \frac{n(n-1) \dots (n-p+1)}{(n+1)(n+2) \dots (n+p)} \int_0^\pi \frac{\cos p\theta}{u^{n+1}} d\theta. \quad (2)$$

In the value of $\int_0^\pi u^n \cos p\theta d\theta$ established in Art. 1153, it is to be noted that p has been assumed not greater than n .

If p be $> n$ no term containing $\cos p\theta$ would occur in the expansion of u^n ; $\therefore \int_0^\pi u^n \cos p\theta d\theta = 0$ ($p > n$).

If $n=p$, we have $\int_0^\pi u^n \cos n\theta d\theta = (-1)^n \pi a^n$.

The results of this article are due to Euler (vol. iv., *Calc. Intég.*, p. 194, etc.). The method of proof is that of Legendre (*Exercices*, p. 576).

1155. The Equation $\int_0^\pi u^n d\theta = (1-a^2)^{2n+1} \int_0^\pi \frac{d\theta}{u^{n+1}}$ may be established directly by the transformation

$$(1-2a \cos \theta + a^2)(1-2a^2 \cos \theta' + a^2) = (1-a^2)^2,$$

which has an interesting geometrical interpretation due to the late Dr. N. M. Ferrers.*

Moreover, so far it has been assumed that n is a positive integer. It will be seen from what follows that this limitation is no longer necessary.

Take a circle of radius a and centre O and a point B within the circle at a distance b from the centre.

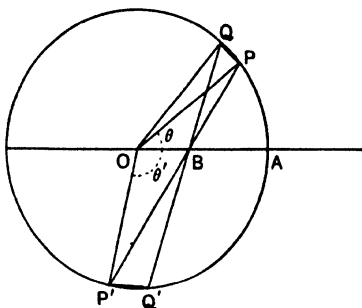

Fig. 336.

Let PBP' be any chord through B , and let the portions PB , BP' subtend angles θ , θ' at the centre; then

$$PB^2 = a^2 + b^2 - 2ab \cos \theta,$$

$$BP'^2 = a^2 + b^2 - 2ab \cos \theta',$$

and

$$(a^2 + b^2 - 2ab \cos \theta)(a^2 + b^2 - 2ab \cos \theta') = PB^2 \cdot BP'^2 = (a^2 - b^2)^2.$$

Also, if QBQ' be a contiguous position of the chord, the elementary triangles BPQ , $BQ'P'$ are similar; hence

$$\frac{d\theta}{-d\theta'} = Lt \frac{PQ}{P'Q'} = Lt \frac{BP}{BQ'} = \frac{BP}{BP'} = \frac{(a^2 + b^2 - 2ab \cos \theta)^{\frac{1}{2}}}{(a^2 + b^2 - 2ab \cos \theta')^{\frac{1}{2}}} = \frac{a^2 - b^2}{a^2 + b^2 - 2ab \cos \theta'}.$$

$$\begin{aligned} \therefore (a^2 + b^2 - 2ab \cos \theta)^n d\theta &= - \frac{(a^2 - b^2)^{2n}}{(a^2 + b^2 - 2ab \cos \theta')^n} \frac{(a^2 - b^2)}{a^2 + b^2 - 2ab \cos \theta'} d\theta' \\ &= - \frac{(a^2 - b^2)^{2n+1}}{(a^2 + b^2 - 2ab \cos \theta')^{n+1}} d\theta'. \end{aligned}$$

* See *Solutions of Senate House Problems and Riders*, 1878. Edited by Mr. J. W. L. Glaisher.

If the chord be allowed to rotate so that θ increases from $\theta=0$ to $\theta=\pi$, then θ' decreases from $\theta'=\pi$ to $\theta'=0$. Hence, integrating and replacing θ' by θ ,

$$\int_0^\pi (a^2 - 2ab \cos \theta + b^2)^n d\theta = (a^2 - b^2)^{2n+1} \int_0^\pi \frac{d\theta}{(a^2 - 2ab \cos \theta + b^2)^{n+1}}.$$

Taking the radius a to be unity and replacing b by a , we have the equation established otherwise by Euler and Legendre above.

Writing $c \cos \frac{\alpha}{2}$, $c \sin \frac{\alpha}{2}$ for a and b respectively, the equation may be thrown into the compact form

$$\int_0^\pi (1 - \sin \alpha \cos \theta)^n d\theta = (\cos \alpha)^{2n+1} \int_0^\pi \frac{d\theta}{(1 - \sin \alpha \cos \theta)^{n+1}}.$$

1156. Another Interpretation of the Integral.

The integral may also be interpreted in connection with the angles known in elliptic motion as the True and Eccentric Anomalies.

Let S and C be the focus and centre of an ellipse, A' the end of the major axis most remote from S , and A the nearer

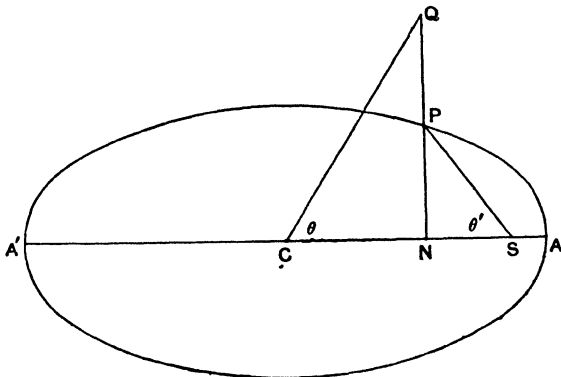

Fig. 337.

end, P a point on the curve, NP its ordinate, and Q the corresponding point on the auxiliary circle. Then $A'SP$ is the supplement of the "true anomaly," and SCQ is the "eccentric anomaly." Let these angles be θ' and θ respectively.

Then, from the polar equation of the ellipse,

$$\frac{CA(1-e^2)}{SP} = 1 - e \cos \theta',$$

and also $SP = CA - e \cdot CN = CA(1 - e \cos \theta)$.

Hence $(1 - e \cos \theta)(1 - e \cos \theta') = 1 - e^2$;

and if we write $\sin \alpha$ for e , i.e.

$$e = \frac{2 \tan \frac{\alpha}{2}}{1 + \tan^2 \frac{\alpha}{2}} = \frac{2ab}{a^2 + b^2} \quad \left(\text{where } \tan \frac{\alpha}{2} = \frac{b}{a} \right),$$

we have

$$(a^2 + b^2 - 2ab \cos \theta)(a^2 + b^2 - 2ab \cos \theta') = (a^2 - b^2)^2 \text{ as before.}$$

The case when $n = \frac{1}{2}$, viz.

$$\int_0^\pi \sqrt{a^2 - 2ab \cos \theta + b^2} d\theta = (a^2 - b^2)^2 \int_0^\pi \frac{d\theta}{(a^2 - 2ab \cos \theta + b^2)^{\frac{3}{2}}},$$

may be written

$$\int_0^\pi \sqrt{(a+b)^2 - 4ab \cos^2 \frac{\theta}{2}} d\theta = (a^2 - b^2)^2 \int_0^\pi \frac{d\theta}{\left((a+b)^2 - 4ab \cos^2 \frac{\theta}{2} \right)^{\frac{3}{2}}},$$

or putting $\frac{\theta}{2} = \frac{\pi}{2} - \phi$ and $\frac{4ab}{(a+b)^2} = k^2 = 1 - k'^2$,

$$\int_0^{\frac{\pi}{2}} (1 - k^2 \sin^2 \phi)^{\frac{1}{2}} d\phi = \left(\frac{a-b}{a+b} \right)^2 \int_0^{\frac{\pi}{2}} \frac{d\phi}{(1 - k^2 \sin^2 \phi)^{\frac{3}{2}}},$$

that is,

$$\int_0^{\frac{\pi}{2}} \Delta d\phi = k^2 \int_0^{\frac{\pi}{2}} \frac{d\phi}{\Delta^3},$$

and is therefore Legendre's Elliptic Integral formula of transformation, Ex. 1, p. 399, with the superior limit $\frac{\pi}{2}$.

1157. A Group of Integrals of Different Form.

Generally, if we have a known series of one of the forms

$$\begin{aligned} f(x) &= A_0 + A_1 \cos cx + A_2 \cos 2cx + A_3 \cos 3cx + \dots, \\ F(x) &= B_1 \sin cx + B_2 \sin 2cx + B_3 \sin 3cx + \dots, \end{aligned}$$

we have, by the integrals of Arts. 1048...1051, viz.

$$\begin{aligned} \int_0^\infty \frac{\sin cx}{x(1+x^2)} dx &= \frac{\pi}{2} (1 - e^{-c}); & \int_0^\infty \frac{\cos cx}{1+x^2} dx &= \frac{\pi}{2} e^{-c}; \\ \int_0^\infty \frac{x \sin cx}{1+x^2} dx &= \frac{\pi}{2} e^{-c}, \end{aligned}$$

where c is positive,

$$\begin{aligned}\int_0^{\infty} \frac{f(x)}{1+x^2} dx &= \frac{\pi}{2} (A_0 + A_1 e^{-c} + A_2 e^{-2c} + A_3 e^{-3c} + \dots), \\ \int_0^{\infty} \frac{F(x)}{x(1+x^2)} dx &= \frac{\pi}{2} [B_1(1 - e^{-c}) + B_2(1 - e^{-2c}) + B_3(1 - e^{-3c}) + \dots], \\ \int_0^{\infty} \frac{x F(x)}{1+x^2} dx &= \frac{\pi}{2} (B_1 e^{-c} + B_2 e^{-2c} + B_3 e^{-3c} + \dots).\end{aligned}$$

Accordingly, taken in conjunction with the particular class of series given in Art. 1134, we obtain another numerous group of definite integrals.

ILLUSTRATIVE EXAMPLES. (c positive throughout.)

1158. 1. Since $\frac{\sin cx}{u} = \sin cx + a \sin 2cx + a^2 \sin 3cx + \dots$ ($a^2 < 1$), where $u = 1 - 2a \cos cx + a^2$, we have

$$\begin{aligned}\int_0^{\infty} \frac{x \sin cx}{1+x^2} \frac{1}{u} dx &= \int_0^{\infty} \frac{x}{1+x^2} (\sin cx + a \sin 2cx + a^2 \sin 3cx + \dots) dx \\ &= \frac{\pi}{2} (e^{-c} + a e^{-2c} + a^2 e^{-3c} + \dots) \\ &= \frac{\pi}{2} \frac{e^{-c}}{1 - a e^{-c}} = \frac{\pi}{2} \frac{1}{e^c - a}.\end{aligned}$$

[LEGENDRE, *Exercices*, vol. ii, p. 123.]

2. Show that $\int_0^{\infty} \frac{dx}{(1+x^2)u} = \frac{\pi}{2} \frac{1}{1-a^2} \frac{1+a e^{-c}}{1-a e^{-c}}$ ($a^2 < 1$)

or $= \frac{\pi}{2} \frac{1}{a^2-1} \frac{a+e^{-c}}{a-e^{-c}}$ ($a^2 > 1$).

3. Show that $\int_0^{\infty} \frac{x \sin cx}{(1+x^2)u^2} dx = \frac{\pi}{2} \frac{1}{1-a^2} \frac{e^{-c}}{(1-a e^{-c})^2}$ ($a^2 < 1$).

4. Show that

$$\int_0^{\infty} \frac{dx}{(1+x^2)u^2} = \frac{\pi}{2} \frac{1}{(1-a^2)^2} \frac{1+a^2 + (2a-3a^2)e^{-c} - 3a^2 e^{-2c} + 8a^3 e^{-3c}}{(1-a e^{-c})^2} \quad (a^2 < 1).$$

5. Show that $\int_0^{\infty} \frac{x}{1+x^2} \tan^{-1} \frac{a \sin cx}{1-a \cos cx} dx = -\frac{\pi}{2} \log(1 - a e^{-c})$ ($a^2 < 1$),

$$\int_0^{\infty} \frac{x}{1+x^2} \tan^{-1} \frac{\sin cx}{a - \cos cx} dx = -\frac{\pi}{2} \log\left(1 - \frac{1}{a} e^{-c}\right) \quad (a^2 > 1).$$

6. Show that $\int_0^{\infty} \frac{1}{1+x^2} \log\left(2 \cos \frac{cx}{2}\right) dx = \frac{\pi}{2} \log(1 + e^{-c})$.

7. Show that $\int_0^{\infty} \frac{1}{1+x^2} \log\left(2 \sin \frac{cx}{2}\right) dx = \frac{\pi}{2} \log(1 - e^{-c})$.

8. Show that $\int_0^{\infty} \frac{\log u}{1+x^2} dx = \pi \log(1 - a e^{-c})$ ($a^2 \leq 1$)

or $= \pi \log(a - e^{-c})$ ($a^2 > 1$).

9. From the last example deduce

$$\int_0^{\infty} \log \tan \frac{cx}{2} \frac{dx}{1+x^2} = \frac{\pi}{2} \log \frac{1-e^{-c}}{1+e^{-c}}.$$

[GEORGES BIDONE, *Mém. de Turin*, vol. xx.]

EXAMPLES.

1. Show that
$$\int_0^{\pi} \frac{dx}{u^2} = \pi \frac{1+a^2}{(1-a^2)^3},$$

where $u \equiv 1 - 2a \cos x + a^2$ and $a^2 < 1$.

2. Show that
$$\int_0^{\pi} \frac{\cos nx}{u^2} dx = \pi \frac{a^n}{(1-a^2)^3} \{(n+1) - (n-1)a^2\} \quad (a^2 < 1).$$

3. Show that

$$\int_0^{\pi} \frac{\sin x \sin nx}{u^3} dx = \frac{\pi}{4} \frac{na^{n-1}}{(1-a^2)^3} \{(n+1) - (n-1)a^2\} \quad (a^2 < 1).$$

4. Show that
$$\int_0^{\pi} \frac{\cos nx dx}{(b^2+x^2)u} = \frac{\pi}{2b} \frac{1}{1-a^2} \frac{(1-a^2)e^{-nb} - 2a^{n+1} \sinh b}{1-2a \cosh b + a^2}.$$

5. Show that
$$\int_0^{\infty} \frac{\log \tan x}{1+x^2} dx = \frac{\pi}{2} \log \tanh e.$$

6. Show that
$$\int_0^{\pi} \frac{\cos n\theta}{25-24 \cos \theta} d\theta = \frac{\pi}{7} \left(\frac{3}{4}\right)^n.$$

7. Show that
$$\int_0^{\pi} \log (25-24 \cos \theta) d\theta = 4\pi \log 2.$$

8. Show that (a)
$$\int_0^{\pi} \frac{\sin \theta}{25-24 \cos \theta} d\theta = \frac{1}{12} \log 7;$$

(b)
$$\int_0^{\pi} \frac{\sin \theta}{(25-24 \cos \theta)^n} d\theta = \frac{1}{24} \cdot \frac{1}{n-1} \left(1 - \frac{1}{49^{n-1}}\right).$$

9. Show that
$$\int_0^{\pi} \frac{\theta \sin \theta}{5-4 \cos \theta} d\theta = \frac{\pi}{2} \log \frac{3}{2}.$$

10. Show that
$$\int_0^{\pi} \frac{\sin \theta}{(5-4 \cos \theta)^2} d\theta = \frac{2}{9}.$$

11. Show that
$$\int_0^{\pi} \frac{\sin \theta \sin n\theta}{(5-4 \cos \theta)^3} d\theta = \frac{n(3n+5)}{2^{n+3}} \cdot \frac{\pi}{27}.$$

12. Show that
$$\int_0^{\pi} \frac{\sin^2 \theta}{(5-3 \cos \theta)^3} d\theta = \frac{\pi}{27}.$$

13. Show that
$$\int_0^{\pi} \sin p\theta \log u d\theta$$

$$= -\sum_1^{\infty} \frac{1}{n} a^n [1 - (-1)^{p+n}] \frac{2p}{p^2-n^2} \quad (a^2 < 1)$$

or
$$= \frac{1-\cos p\pi}{p} \log a^2 - \sum_1^{\infty} \frac{1}{na^n} [1 - (-1)^{p+n}] \frac{2p}{p^2-n^2} \quad (a^2 > 1),$$

where the term for which $n=p$ is omitted in the summation, p being a positive integer.

14. Show that

$$\int_0^\pi \frac{\sin p\theta}{x^3} d\theta = \frac{1}{(1-a^2)^3} \left[(1+4a^2+a^4) \frac{1-\cos p\pi}{p} + \sum_1^\infty A_n \{1 - (-1)^{p+n}\} \frac{p}{p^2-n^2} \right]$$

($a^2 < 1$),

the term where $n=p$ being omitted in the summation (Art. 1136).

1159. On the Transition from a Real Value of k to a Complex Value of k in the Formula for $\int_0^\infty e^{-kx} x^{n-1} dx$. M. SERRET'S INVESTIGATION.

In establishing the result

$$\int_0^\infty e^{-kx} x^{n-1} dx = \frac{\Gamma(n)}{k^n}, \quad (n > 0), \quad (\text{Art. 864}),$$

it was assumed throughout the proof that k was real. We cannot therefore assume the theorem as still true for complex values of k without further investigation. We consider the integral

$$I \equiv \int_0^\infty e^{-(a-ib)x} x^{n-1} dx, \quad \text{where } i \equiv \sqrt{-1}.$$

Then I will be finite if a be positive.

Since $e^{-(a-ib)x} = e^{-ax}(\cos bx + i \sin bx)$ the integral consists of two separate integrals, viz.

$$\int_0^\infty e^{-ax} \cos bx x^{n-1} dx + i \int_0^\infty e^{-ax} \sin bx x^{n-1} dx.$$

Let R, Φ be respectively the modulus and argument of I . Thus

$$R e^{i\Phi} = \int_0^\infty e^{-(a-ib)x} x^{n-1} dx.$$

Let $b = a \tan \phi$, ϕ lying between $-\frac{\pi}{2}$ and $+\frac{\pi}{2}$, so that

$$R e^{i\Phi} = \int_0^\infty e^{-ax} e^{iax \tan \phi} x^{n-1} dx.$$

Then differentiating with regard to ϕ ,

$$R e^{i\Phi} \left[\frac{\partial \log R}{\partial \phi} + i \frac{\partial \Phi}{\partial \phi} \right] = ia \sec^2 \phi \int_0^\infty e^{-ax} e^{iax \tan \phi} x^n dx.$$

Integrating by parts,

$$\int_0^\infty e^{-(a-ib)x} x^n dx = \left[\frac{e^{-(a-ib)x} x^n}{-(a-ib)} \right]_0^\infty + \frac{n}{a-ib} \int_0^\infty e^{-(a-ib)x} x^{n-1} dx,$$

and the portion between square brackets vanishes at both limits, a being positive.

$$\text{Hence } Re^{i\phi} \left(\frac{\partial \log R}{\partial \phi} + i \frac{\partial \Phi}{\partial \phi} \right) = \frac{n}{a-ib} (a \sec^2 \phi) Re^{i\phi} \\ = n(1 - \tan^2 \phi) Re^{i\phi};$$

$$\therefore \frac{\partial \log R}{\partial \phi} = -n \tan^2 \phi \quad \text{and} \quad \frac{\partial \Phi}{\partial \phi} = n;$$

$$\therefore \log R = n \log \cos \phi + \log A \quad \text{and} \quad \Phi = n\phi + B,$$

where A and B are independent of ϕ .

$$i.e. \quad R = A \cos^n \phi, \quad \Phi = n\phi + B.$$

But when ϕ vanishes $b=0$, and the integral is

$$\int_0^\infty e^{-ax} x^{n-1} dx = \frac{\Gamma(n)}{a^n}, \quad \text{and } \Phi \text{ vanishes.}$$

$$\text{Hence } B=0 \text{ and } A = \frac{\Gamma(n)}{a^n}; \quad \text{hence } R = \frac{\Gamma(n)}{a^n} \cos^n \phi, \quad \Phi = n\phi.$$

Hence

$$I = \frac{\Gamma(n) \cos^n \phi}{a^n} (\cos n\phi + i \sin n\phi) = \frac{\Gamma(n)}{a^n (1 - i \tan \phi)^n} = \frac{\Gamma(n)}{(a-ib)^n}.$$

$$\text{So the theorem } \int_0^\infty e^{-kx} x^{n-1} dx = \frac{\Gamma(n)}{k^n}$$

still holds when k is complex, provided the real part a of the complex is positive.*

If n be a fractional quantity, $\frac{p}{q}$, $(a-ib)^n$ will be susceptible of q values and no more, if its argument be unrestricted in value. We must then obtain the argument of $(a-ib)^n$ by multiplying by n the argument of $a-ib$ taken between the limits $-\frac{\pi}{2}$ and $\frac{\pi}{2}$.

1160. We then have the two integrals

$$\left. \begin{aligned} \int_0^\infty e^{-ax} \cos bx x^{n-1} dx &= \frac{\Gamma(n)}{a^n} \cos^n \phi \cos n\phi = \frac{\Gamma(n)}{b^n} \sin^n \phi \cos n\phi, \\ \int_0^\infty e^{-ax} \sin bx x^{n-1} dx &= \frac{\Gamma(n)}{a^n} \cos^n \phi \sin n\phi = \frac{\Gamma(n)}{b^n} \sin^n \phi \sin n\phi, \end{aligned} \right\} \dots (A)$$

$$i.e. \quad \int_0^\infty e^{-ax} x^{n-1} \cos bx dx = \frac{\Gamma(n)}{(a^2 + b^2)^{\frac{n}{2}}} \cos \left(n \tan^{-1} \frac{b}{a} \right),$$

$$\int_0^\infty e^{-ax} x^{n-1} \sin bx dx = \frac{\Gamma(n)}{(a^2 + b^2)^{\frac{n}{2}}} \sin \left(n \tan^{-1} \frac{b}{a} \right).$$

* See Serret, *Calcul Intégral*, p. 193.

These results (A) are then so far established on the understanding that a is a positive quantity.

1161. When a vanishes the integral $\int_0^\infty e^{bx} x^{n-1} dx$ may still be finite if n be a positive proper fraction.

Consider either integral, say $\int_0^\infty e^{-ax} \sin bx x^{n-1} dx$ ($b, +ve$).

This is equal to

$$\left[\int_0^{\frac{\pi}{b}} + \int_{\frac{\pi}{b}}^{\frac{2\pi}{b}} + \int_{\frac{2\pi}{b}}^{\frac{3\pi}{b}} + \dots + \int_{\frac{r\pi}{b}}^{\frac{(r+1)\pi}{b}} + \dots \right] e^{-ax} \sin bx x^{n-1} dx.$$

Let $(-1)^r u_r = \int_{\frac{r\pi}{b}}^{\frac{(r+1)\pi}{b}} e^{-ax} \sin bx x^{n-1} dx$, and write $\frac{z+r\pi}{b}$ for x ,

$$(-1)^r u_r = \int_0^\pi e^{-a \frac{z+r\pi}{b}} \sin(z+r\pi) \cdot \left(\frac{z+r\pi}{b}\right)^{n-1} \frac{dz}{b},$$

i.e.
$$u_r = \frac{1}{b^n} \int_0^\pi e^{-\frac{a}{b}(z+r\pi)} \sin z \cdot (z+r\pi)^{n-1} dz,$$

and the whole integral $\int_0^\infty e^{-ax} \sin bx x^{n-1} dx$ is made up of such terms as this with alternate signs, viz. $\sum_0^\infty (-1)^r u_r$, *i.e.*

$$= u_0 - u_1 + u_2 - u_3 + \dots,$$

which is convergent if $a > 0$, for the terms diminish as r increases and are of alternate sign. But in the case when $a=0$, u_r becomes $u_r' \equiv \frac{1}{b^n} \int_0^\pi \sin z (z+r\pi)^{n-1} dz$, and when r becomes indefinitely large this does not ultimately vanish unless $n < 1$. When this is so, the series

$$u_0' - u_1' + u_2' - u_3' + \dots$$

is convergent, and its sum will be the same as the sum

$$u_0 - u_1 + u_2 - u_3 + \dots$$

for the value $a=0$, $n < 1$.

For if $S = u_0 - u_1 + u_2 - u_3 + \dots$ *ad inf.*,

$$S' = u_0' - u_1' + u_2' - u_3' + \dots,$$

and S_m, S'_m be the sums of the first m terms and R_m, R'_m the remainders respectively,

$$S = S_m + R_m, \quad S' = S'_m + R'_m,$$

i.e.
$$S - S' = S_m - S'_m + R_m - R'_m.$$

But $S_m - S'_m = 0$ when $a=0$, and R_m, R'_m separately diminish indefinitely as m increases indefinitely. Hence $S - S' = 0$ when $a=0$ and $0 < n < 1$.

Hence formulae (A) become, when $a=0$, and therefore $\phi = \frac{\pi}{2}$,

$$\left. \begin{aligned} \int_0^\infty x^{n-1} \cos bx \, dx &= \frac{\Gamma(n)}{b^n} \cos \frac{n\pi}{2}, \\ \int_0^\infty x^{n-1} \sin bx \, dx &= \frac{\Gamma(n)}{b^n} \sin \frac{n\pi}{2}, \end{aligned} \right\} \text{(B), where } n \text{ is a positive proper fraction (} b \text{ positive).}$$

1162. Putting $x = z^\lambda$ and $n\lambda = p$, we have

$$\left. \begin{aligned} \int_0^\infty z^{p-1} \cos bz^\lambda \, dz &= \frac{\Gamma\left(\frac{p}{\lambda}\right)}{\lambda b^{\frac{p}{\lambda}}} \cos \frac{p\pi}{2\lambda}, \\ \int_0^\infty z^{p-1} \sin bz^\lambda \, dz &= \frac{\Gamma\left(\frac{p}{\lambda}\right)}{\lambda b^{\frac{p}{\lambda}}} \sin \frac{p\pi}{2\lambda}, \end{aligned} \right\} \text{(B'), where } p < \lambda \text{ and both are positive (} b \text{ positive).}$$

1163. Since $\Gamma(n)\Gamma(1-n) = \frac{\pi}{\sin n\pi}$, the integrals (B) may be written

$$\left. \begin{aligned} \int_0^\infty x^{n-1} \cos bx \, dx &= \frac{\pi}{\sin \frac{n\pi}{2}} \frac{1}{2b^n \Gamma(1-n)}, \\ \int_0^\infty x^{n-1} \sin bx \, dx &= \frac{\pi}{\cos \frac{n\pi}{2}} \frac{1}{2b^n \Gamma(1-n)}. \end{aligned} \right\} \dots\dots\dots \text{(C)}$$

1164. M. Serret points out that the latter integral remains finite when n is indefinitely diminished to zero, and that the formula then reduces to

$$\int_0^\infty \frac{\sin bx}{x} \, dx = \frac{\pi}{2} \quad (b \text{ positive}).$$

1165. If we write $1-n=m$, m being a positive proper fraction, the formulae (C) take the form

$$\left. \begin{aligned} \int_0^\infty \frac{\cos bx}{x^m} dx &= \frac{\pi}{\cos \frac{m\pi}{2}} \frac{b^{m-1}}{2\Gamma(m)}, \\ \int_0^\infty \frac{\sin bx}{x^m} dx &= \frac{\pi}{\sin \frac{m\pi}{2}} \frac{b^{m-1}}{2\Gamma(m)}, \end{aligned} \right\} \begin{array}{l} 0 < m < 1 \\ (b \text{ positive}). \end{array} \quad (D)$$

1166. The case $m=\frac{1}{2}$ gives

$$\left. \begin{aligned} \int_0^\infty \frac{\cos bx}{\sqrt{x}} dx &= \frac{\pi}{\cos \frac{\pi}{4}} \frac{b^{-\frac{1}{2}}}{2\Gamma(\frac{1}{2})} = \frac{\sqrt{\pi}}{\sqrt{2b}}, \\ \int_0^\infty \frac{\sin bx}{\sqrt{x}} dx &= \frac{\pi}{\sin \frac{\pi}{4}} \frac{b^{-\frac{1}{2}}}{2\Gamma(\frac{1}{2})} = \frac{\sqrt{\pi}}{\sqrt{2b}}, \end{aligned} \right\} (b \text{ positive}). \quad \dots(E)$$

Putting $x=z^2$ in these integrals,

$$\int_0^\infty \cos bz^2 dz = \int_0^\infty \sin bz^2 dz = \frac{1}{2} \sqrt{\frac{\pi}{2b}} \quad (b \text{ positive});$$

and if we put $b=\frac{\pi}{2}$, we have

$$\int_0^\infty \cos \frac{\pi z^2}{2} dz = \int_0^\infty \sin \frac{\pi z^2}{2} dz = \frac{1}{2}. \quad \dots\dots\dots(F)$$

These two integrals are known as Fresnel's Integrals, and will be considered more fully in Art. 1169.

The groups of integrals of these articles are due to Euler (*Calc. Intégral*, vol. iv., p. 337, etc.). They are also discussed by Laplace, vol. viii., *Journal de l'École Polytechnique*, p. 244, etc., by Legendre, *Exercices*, p. 367, etc., by Serret, *Calc. Intég.*, p. 193, etc.

1167. Further Results.

Returning to formulae (A), viz.

$$\left. \begin{aligned} \int_0^\infty e^{-ax} x^{n-1} \cos bx dx &= \frac{\Gamma(n)}{a^n} \cos^n \phi \cos n\phi, \\ \int_0^\infty e^{-ax} x^{n-1} \sin bx dx &= \frac{\Gamma(n)}{a^n} \cos^n \phi \sin n\phi, \end{aligned} \right\} \text{where } b = a \tan \phi,$$

and putting $n=1$, we have the well-known results

$$\left. \begin{aligned} \int_0^\infty e^{-ax} \cos bx dx &= \frac{a}{a^2 + b^2}, \\ \int_0^\infty e^{-ax} \sin bx dx &= \frac{b}{a^2 + b^2}. \end{aligned} \right\}$$

Again remembering that $b = a \tan \phi$, we have $b^m = a^m \tan^m \phi$, and keeping a constant,

$$b^{m-1} db = a^m \tan^{m-1} \phi \sec^2 \phi d\phi.$$

Hence multiplying the integrals by the sides of this identity, and integrating with regard to b from $b=0$ to $b=\infty$, and therefore with regard to ϕ from $\phi=0$ to $\phi=\frac{\pi}{2}$, and taking $1 > m > 0$,

$$\Gamma(n) a^{m-n} \int_0^{\frac{\pi}{2}} \sin^{m-1} \phi \cos^{n-m-1} \phi \cos n\phi d\phi = \int_0^{\infty} \int_0^{\infty} e^{-ax} x^{n-1} b^{m-1} \cos bx dx db,$$

and

$$\Gamma(n) a^{m-n} \int_0^{\frac{\pi}{2}} \sin^{m-1} \phi \cos^{n-m-1} \phi \sin n\phi d\phi = \int_0^{\infty} \int_0^{\infty} e^{-ax} x^{n-1} b^{m-1} \sin bx dx db.$$

The right-hand sides of these integrals are respectively (taking $n > m$),

$$\int_0^{\infty} e^{-ax} x^{n-1} \frac{\Gamma(m)}{x^m} \cos \frac{m\pi}{2} dx \quad \text{and} \quad \int_0^{\infty} e^{-ax} x^{n-1} \frac{\Gamma(m)}{x^m} \sin \frac{m\pi}{2} dx$$

by formulae (B),

i.e. $\frac{\Gamma(n-m)}{a^{n-m}} \cdot \Gamma(m) \cos \frac{m\pi}{2}$ and $\frac{\Gamma(n-m)}{a^{n-m}} \Gamma(m) \sin \frac{m\pi}{2}$;

whence we obtain

$$\left. \begin{aligned} \int_0^{\frac{\pi}{2}} \sin^{m-1} \phi \cos^{n-m-1} \phi \cos n\phi d\phi &= \frac{\Gamma(m)\Gamma(n-m)}{\Gamma(n)} \cos \frac{m\pi}{2}, \\ \int_0^{\frac{\pi}{2}} \sin^{m-1} \phi \cos^{n-m-1} \phi \sin n\phi d\phi &= \frac{\Gamma(m)\Gamma(n-m)}{\Gamma(n)} \sin \frac{m\pi}{2}, \end{aligned} \right\} \begin{array}{l} n > m, \\ 1 > m > 0. \end{array} \quad (G)$$

and taking $n = m + 1$,

$$\left. \begin{aligned} \int_0^{\frac{\pi}{2}} \sin^{n-2} \phi \cos n\phi d\phi &= \frac{1}{n-1} \sin \frac{n\pi}{2}, \\ \int_0^{\frac{\pi}{2}} \sin^{n-2} \phi \sin n\phi d\phi &= -\frac{1}{n-1} \cos \frac{n\pi}{2}, \end{aligned} \right\} (2 > n > 1). \quad \dots\dots (H)$$

Replacing ϕ by $\frac{\pi}{2} - \phi$ in formulae (H), we derive

$$\left. \begin{aligned} \int_0^{\frac{\pi}{2}} \cos^{n-2} \phi \cos n\phi d\phi &= 0, \\ \int_0^{\frac{\pi}{2}} \cos^{n-2} \phi \sin n\phi d\phi &= \frac{1}{n-1}, \end{aligned} \right\} \dots\dots\dots (I)$$

that is the formulae (G) still hold good in the limiting case $m = 1$.

1168. Since $\Gamma(m) \Gamma(1-m) = \frac{\pi}{\sin m\pi}$ formulae (G) may be written

$$\left. \begin{aligned} \int_0^{\frac{\pi}{2}} \sin^{m-1} \phi \cos^{n-m-1} \phi \cos n\phi d\phi &= \frac{\Gamma(n-m)}{\Gamma(n) \Gamma(1-m)} \frac{\pi}{2 \sin \frac{m\pi}{2}}, \\ \int_0^{\frac{\pi}{2}} \sin^{m-1} \phi \cos^{n-m-1} \phi \sin n\phi d\phi &= \frac{\Gamma(n-m)}{\Gamma(n) \Gamma(1-m)} \frac{\pi}{2 \cos \frac{m\pi}{2}}, \end{aligned} \right\} \begin{array}{l} (n > m), \\ (1 > m > 0). \end{array} \quad (J)$$

When m diminishes indefinitely to zero, the limiting form of the first of these integrals is infinite. The second takes the limiting form

$$\int_0^{\frac{\pi}{2}} \cos^{n-1} \phi \frac{\sin n\phi}{\sin \phi} d\phi = \frac{\pi}{2}. \dots\dots\dots(K)$$

It will be noted that the integral (K) is independent of n .

These results are given by M. Serret, *Calc. Intég.*, pp. 199 to 201.

Differentiating the equations

$$\left. \begin{aligned} \int_0^\infty x^{n-1} e^{-ax} \cos bx \, dx &= \frac{\cos n\theta}{r^n} \Gamma(n), \\ \int_0^\infty x^{n-1} e^{-ax} \sin bx \, dx &= \frac{\sin n\theta}{r^n} \Gamma(n), \end{aligned} \right\} \text{ where } r = \sqrt{a^2 + b^2} \text{ and } \theta = \tan^{-1} \frac{b}{a},$$

with respect to n , we have

$$\int_0^\infty x^{n-1} e^{-ax} \cos bx \log x \, dx = \frac{\cos n\theta}{r^n} \frac{d\Gamma(n)}{dn} - \left(\frac{\theta \sin n\theta + \cos n\theta \log r}{r^n} \right) \Gamma(n),$$

$$\int_0^\infty x^{n-1} e^{-ax} \sin bx \log x \, dx = \frac{\sin n\theta}{r^n} \frac{d\Gamma(n)}{dn} + \left(\frac{\theta \cos n\theta - \sin n\theta \log r}{r^n} \right) \Gamma(n);$$

and eliminating $\frac{d\Gamma(n)}{dn}$,

$$\int_0^\infty x^{n-1} e^{-ax} \sin(n\theta - bx) \log \frac{1}{x} \, dx = \frac{\theta}{r^n} \Gamma(n);$$

and if $n = 1$,
$$\int_0^\infty e^{-ax} \sin(\theta - bx) \log \frac{1}{x} \, dx = \frac{\theta}{r}$$

where
$$r = \sqrt{a^2 + b^2} \text{ and } \theta = \tan^{-1} \frac{b}{a}.$$

Also $\frac{d\Gamma(n)}{dn}$ could be approximated to by means of the tables for $\log \Gamma(n)$ if required.

These results are due to Legendre (*Exercices*, p. 369).

1169. FRESNEL'S INTEGRALS.

We have met the integrals

$$\int_0^\infty \cos \frac{\pi}{2} x^2 \, dx = \int_0^\infty \sin \frac{\pi}{2} x^2 \, dx = \frac{1}{2},$$

known as Fresnel's Integrals, in an earlier chapter, viz. in the tracing of Cornu's Spiral $ks^2 = \psi$ (Art. 560). They are of importance in the Theory of Light. Students interested in the employment of the integrals in Physical Optics are referred to Verdet's *Œuvres*, tom. v., or to Preston's *Theory of Light*, where the various methods adopted in the construction of tables for their values between limits 0 and v will be found explained at length.

Preston gives in the form of examples with hints at solution a very excellent condensation of the chief results arrived at by various investigators—Fresnel, Gilbert, Cauchy, Knochenhauer and Cornu (Preston, *Theory of Light*, pages 220-223).

1170. We may consider shortly some modes of calculation of the more general integral

$$\int_0^a \cos \phi(x) dx, \quad \text{where } \phi(x) \equiv A_0 x^n + A_1 x^{n-1} + A_2 x^{n-2} + \dots$$

Take first two near limits, a and $a+h$, where h is small.

$$\begin{aligned} \text{Then } \int_a^{a+h} \cos \phi(x) dx &= \int_0^h \cos \phi(a+y) dy, \text{ by putting } x = a+y, \\ &= \int_0^h \cos \{ \phi(a) + y \phi'(a) \} dy \text{ nearly,} \end{aligned}$$

since y lies between 0 and h , and is therefore itself small,

$$= \frac{\sin \{ \phi(a) + h \phi'(a) \} - \sin \phi(a)}{\phi'(a)} \text{ nearly.}$$

Hence, by taking the limits successively, 0 to h , h to $2h$, $2h$ to $3h$, etc., and adding the results, we may obtain a close approximation to $\int_0^{nh} \cos \phi(x) dx$, provided, of course, that $\phi(x)$ is such that $\phi'(x) = 0$ has no root between 0 and nh .

1171. A closer approximation may be made as follows :

$$\text{Since } F(\mu+y) = F(\mu) + y F'(\mu) + \frac{y^2}{2!} F''(\mu) + \dots,$$

we have, by integration between limits $-\frac{h}{2}$ and $\frac{h}{2}$,

$$\int_{-\frac{h}{2}}^{\frac{h}{2}} F(\mu+y) dy = h F(\mu) + \frac{1}{3!} \frac{2h^3}{2^3} F'''(\mu) + \frac{1}{5!} \frac{2h^5}{2^5} F^{(5)}(\mu) + \dots,$$

and if $F(x) \equiv \cos \phi(x)$, $\mu = a + \frac{h}{2}$ and $x = \mu + y$,

$$\begin{aligned} \int_a^{a+h} \cos \phi(x) dx &= \int_{-\frac{h}{2}}^{\frac{h}{2}} \cos \phi(\mu+y) dy \\ &= h \cos \phi(\mu) + \frac{1}{3!} \frac{h^3}{4} \frac{d^3}{d\mu^3} \cos \phi(\mu) + \frac{1}{5!} \frac{h^5}{16} \frac{d^5}{d\mu^5} \cos \phi(\mu) + \dots \\ &= h \cos \phi(\mu) - \frac{h^3}{4!} [\cos \phi(\mu) \phi'^2(\mu) + \sin \phi(\mu) \phi''(\mu)] + \dots, \end{aligned}$$

from which result we may proceed as before, taking limits 0 to h , h to $2h$, $2h$ to $3h$, etc., and adding the several results.

1172. Fresnel's calculations were based in the manner described above upon a preliminary consideration of the integrals

$$\int_0^{c+h} \cos \frac{\pi x^2}{2} dx, \quad \int_0^{c+h} \sin \frac{\pi x^2}{2} dx,$$

where the interval h is so small that its square can be rejected.

In this case, putting $x = v + z$,

$$\int_0^{c+h} \cos \frac{\pi x^2}{2} dx = \int_0^h \cos \frac{\pi}{2} (v^2 + 2vz) dz = \frac{1}{\pi v} \left[\sin \frac{\pi}{2} (v^2 + 2vh) - \sin \frac{\pi v^2}{2} \right]$$

and

$$\int_0^{c+h} \sin \frac{\pi x^2}{2} dx = \int_0^h \sin \frac{\pi}{2} (v^2 + 2vz) dz = -\frac{1}{\pi v} \left[\cos \frac{\pi}{2} (v^2 + 2vh) - \cos \frac{\pi v^2}{2} \right].$$

Then taking as intervals $h = \frac{1}{10}$, and making v in succession $0, \frac{1}{10}, \frac{2}{10}, \frac{3}{10}, \dots$, the values of the integrals were approximated to.

1173. The integrals

$$\int_0^r \cos \frac{\pi v^2}{2} dv, \quad \int_0^r \sin \frac{\pi v^2}{2} dv \quad \text{or} \quad \int_r^\infty \cos \frac{\pi v^2}{2} dv, \quad \int_r^\infty \sin \frac{\pi v^2}{2} dv$$

may each be expressed in the form $X \cos \frac{\pi v^2}{2} + Y \sin \frac{\pi v^2}{2}$, where X and Y are series of ascending powers of v , in integrating from 0 to v ; or descending powers of v when the integration extends from v to infinity. In both cases the integration is performed by "Parts."

In integrating from 0 to r we proceed as follows :

$$\begin{aligned} \int_0^r \cos \frac{\pi v^2}{2} dv &= \left[v \cos \frac{\pi v^2}{2} \right]_0^r + \pi \int_0^r v^2 \sin \frac{\pi v^2}{2} dv, \\ \int_0^r v^2 \sin \frac{\pi v^2}{2} dv &= \left[\frac{v^3}{3} \sin \frac{\pi v^2}{2} \right]_0^r - \frac{\pi}{3} \int_0^r v^4 \cos \frac{\pi v^2}{2} dv, \\ \int_0^r v^4 \cos \frac{\pi v^2}{2} dv &= \left[\frac{v^5}{5} \cos \frac{\pi v^2}{2} \right]_0^r + \frac{\pi}{5} \int_0^r v^6 \sin \frac{\pi v^2}{2} dv, \\ \int_0^r v^6 \sin \frac{\pi v^2}{2} dv &= \left[\frac{v^7}{7} \sin \frac{\pi v^2}{2} \right]_0^r - \frac{\pi}{7} \int_0^r v^8 \cos \frac{\pi v^2}{2} dv, \\ &\text{etc.} \end{aligned}$$

Hence multiplying by $1, \pi, \frac{-\pi^2}{1.3}, \frac{-\pi^3}{1.3.5}, \frac{\pi^4}{1.3.5.7}, \frac{\pi^5}{1.3.5.7.9}$, etc., and adding,

$$\begin{aligned} \int_0^r \cos \frac{\pi v^2}{2} dv &= \cos \frac{\pi v^2}{2} \left[v - \frac{\pi^2 v^6}{1.3.5} + \frac{\pi^4 v^9}{1.3.5.7.9} - \dots \right] \\ &+ \sin \frac{\pi v^2}{2} \left[\frac{\pi v^3}{1.3} - \frac{\pi^3 v^7}{1.3.5.7} + \frac{\pi^5 v^{11}}{1.3.5.7.9.11} - \dots \right] \\ &= X \cos \frac{\pi v^2}{2} + Y \sin \frac{\pi v^2}{2}, \text{ say, } \dots \dots \dots (1) \end{aligned}$$

and proceeding in the same way with $\int_0^r \sin \frac{\pi v^2}{2} dv$,

$$\int_0^r \sin \frac{\pi v^2}{2} dv = -Y \cos \frac{\pi v^2}{2} + X \sin \frac{\pi v^2}{2},$$

and the sum of the squares of the integrals (which gives a measure of the intensity of illumination in a certain case in Physical Optics*) is $X^2 + Y^2$.

It is interesting to note that the series X, Y satisfy the equations

$$\frac{dX}{dv} + \pi v Y = 1, \quad \frac{dY}{dv} - \pi v X = 0,$$

i.e. $\frac{1}{v} \frac{d}{dv} \left(\frac{1}{v} \frac{d}{dv} \right) X + \pi^2 X = -\frac{1}{v^3}$ and $\frac{1}{v} \frac{d}{dv} \left(\frac{1}{v} \frac{d}{dv} \right) Y + \pi^2 Y = \frac{\pi}{v},$

or $\left[\left(\frac{d}{dv^2} \right)^2 + \frac{\pi^2}{4} \right] X = -\frac{1}{4v^3}, \quad \left[\left(\frac{d}{dv^2} \right)^2 + \frac{\pi^2}{4} \right] Y = \frac{\pi}{4v}.$

1174. If it be desired to express the integrals with limits v to ∞ in descending powers of v , the integration by parts must be conducted in the opposite order. Thus

$$\begin{aligned} \int_v^\infty \cos \frac{\pi v^2}{2} dv &= \int_v^\infty \frac{1}{\pi v} \left(\pi v \cos \frac{\pi v^2}{2} \right) dv = \left[\frac{1}{\pi v} \sin \frac{\pi v^2}{2} \right]_v^\infty + \int_v^\infty \frac{1}{\pi v^2} \sin \frac{\pi v^2}{2} dv, \\ \int_v^\infty \frac{1}{\pi v^2} \sin \frac{\pi v^2}{2} dv &= \int_v^\infty \frac{1}{\pi^2 v^3} \left(\pi v \sin \frac{\pi v^2}{2} \right) dv = \left[-\frac{1}{\pi^2 v^3} \cos \frac{\pi v^2}{2} \right]_v^\infty - 3 \int_v^\infty \frac{1}{\pi^2 v^4} \cos \frac{\pi v^2}{2} dv, \\ \int_v^\infty \frac{1}{\pi^2 v^4} \cos \frac{\pi v^2}{2} dv &= \int_v^\infty \frac{1}{\pi^3 v^5} \left(\pi v \cos \frac{\pi v^2}{2} \right) dv = \left[\frac{1}{\pi^3 v^5} \sin \frac{\pi v^2}{2} \right]_v^\infty + 5 \int_v^\infty \frac{1}{\pi^3 v^6} \sin \frac{\pi v^2}{2} dv, \\ \int_v^\infty \frac{1}{\pi^3 v^6} \sin \frac{\pi v^2}{2} dv &= \int_v^\infty \frac{1}{\pi^4 v^7} \left(\pi v \sin \frac{\pi v^2}{2} \right) dv = \left[-\frac{1}{\pi^4 v^7} \cos \frac{\pi v^2}{2} \right]_v^\infty - 7 \int_v^\infty \frac{1}{\pi^4 v^8} \cos \frac{\pi v^2}{2} dv, \\ &\text{etc.} \end{aligned}$$

Hence multiplying by 1, 1, -1.3, -1.3.5, +1.3.5.7, etc, and adding,

$$\begin{aligned} \int_v^\infty \cos \frac{\pi}{2} v^2 dv &= \sin \frac{\pi v^2}{2} \left(-\frac{1}{\pi v} + \frac{1.3}{\pi^3 v^5} - \frac{1.3.5.7}{\pi^5 v^9} + \dots \right) \\ &+ \cos \frac{\pi v^2}{2} \left(\frac{1}{\pi^2 v^3} - \frac{1.3.5}{\pi^4 v^7} + \frac{1.3.5.7.9}{\pi^6 v^{11}} - \dots \right) \\ &= X' \cos \frac{\pi v^2}{2} - Y' \sin \frac{\pi v^2}{2}, \text{ say, } \dots \dots \dots (2) \end{aligned}$$

where $X' = \frac{1}{\pi^2 v^3} - \frac{1.3.5}{\pi^4 v^7} + \text{etc.}$ and $Y' = \frac{1}{\pi v} - \frac{1.3}{\pi^3 v^5} + \text{etc.};$

and similarly $\int_v^\infty \sin \frac{\pi v^2}{2} dv = Y' \cos \frac{\pi v^2}{2} + X' \sin \frac{\pi v^2}{2}.$

And, as before, the sum of the squares of the integrals is $X'^2 + Y'^2$.

Also X', Y' satisfy the differential equations

$$\frac{dX'}{dv} = \pi v Y' - 1, \quad \frac{dY'}{dv} = -\pi v X',$$

i.e. $\frac{1}{v} \frac{d}{dv} \frac{1}{v} \frac{dX'}{dv} + \pi^2 X' = \frac{1}{v^3}, \quad \frac{1}{v} \frac{d}{dv} \frac{1}{v} \frac{dY'}{dv} + \pi^2 Y' = \frac{\pi}{v},$

or $\left[\left(\frac{d}{dv^2} \right)^2 + \frac{\pi^2}{4} \right] X' = \frac{1}{4v^3}, \quad \left[\left(\frac{d}{dv^2} \right)^2 + \frac{\pi^2}{4} \right] Y' = \frac{\pi}{4v}.$

We also obviously have

$$\int_v^\infty \cos \frac{\pi v^2}{2} dv = \int_0^\infty \cos \frac{\pi v^2}{2} dv - \int_0^v \cos \frac{\pi v^2}{2} dv = \frac{1}{2} - X' \cos \frac{\pi v^2}{2} - Y' \sin \frac{\pi v^2}{2};$$

* See Preston's *Light*.

and similarly

$$\int_0^\infty \sin \frac{\pi v^2}{2} dv = \int_0^\infty \sin \frac{\pi v^2}{2} dv - \int_0^v \sin \frac{\pi v^2}{2} dv = \frac{1}{2} + Y \cos \frac{\pi v^2}{2} - X \sin \frac{\pi v^2}{2}.$$

Also

$$\int_0^v \cos \frac{\pi v^2}{2} dv = \int_0^\infty \cos \frac{\pi v^2}{2} dv - \int_v^\infty \cos \frac{\pi v^2}{2} dv = \frac{1}{2} - X' \cos \frac{\pi v^2}{2} + Y' \sin \frac{\pi v^2}{2},$$

$$\int_0^v \sin \frac{\pi v^2}{2} dv = \int_0^\infty \sin \frac{\pi v^2}{2} dv - \int_v^\infty \sin \frac{\pi v^2}{2} dv = \frac{1}{2} - Y' \cos \frac{\pi v^2}{2} - X' \sin \frac{\pi v^2}{2}.$$

1175. The expansion (1) in ascending powers of v is due to Knochenhauer.* The expansion (2) in descending powers of v is due to Cauchy.†

For the student of the Integral Calculus, perhaps the most interesting of Mr. Preston's quotations is one which expresses Cauchy's series of the last article in the form of definite integrals. These expressions are quoted from the investigations of Gilbert, published in the *Mémoires couronnés de l'Acad. de Bruxelles*, tom. xxxi., p. 1.

Writing $\frac{\pi v^2}{2} = u$, we have

$$\int_0^v \cos \frac{\pi v^2}{2} dv = \frac{1}{\sqrt{2\pi}} \int_0^u \frac{\cos u}{\sqrt{u}} du, \quad \int_0^v \sin \frac{\pi v^2}{2} dv = \frac{1}{\sqrt{2\pi}} \int_0^u \frac{\sin u}{\sqrt{u}} du.$$

Also
$$\int_0^\infty x^{-\frac{1}{2}} e^{-ux} dx = \frac{\Gamma(\frac{1}{2})}{u^{\frac{1}{2}}} = \frac{\sqrt{\pi}}{\sqrt{u}};$$

$$\therefore \int_0^v \cos \frac{\pi v^2}{2} dv = \frac{1}{\sqrt{2\pi}} \int_0^u \cos u \left[\frac{1}{\sqrt{\pi}} \int_0^\infty \frac{e^{-ux}}{\sqrt{x}} dx \right] du,$$

i.e.
$$\frac{1}{\pi\sqrt{2}} \int_0^u \int_0^\infty \frac{e^{-ux} \cos u}{\sqrt{x}} du dx,$$

or changing the order of integration, which does not alter the limits,

$$\begin{aligned} &= \frac{1}{\pi\sqrt{2}} \int_0^\infty \int_0^u \frac{1}{\sqrt{x}} e^{-ux} \cos u dx du \\ &= \frac{1}{\pi\sqrt{2}} \int_0^\infty \frac{1}{\sqrt{x}} \left[-e^{-ux} \frac{x \cos u - \sin u}{1+x^2} \right]_0^u dx \\ &= \frac{1}{\pi\sqrt{2}} \int_0^\infty \frac{1}{\sqrt{x}} \left[\frac{x}{1+x^2} - e^{-ux} \frac{x \cos u - \sin u}{1+x^2} \right] du \\ &= \frac{1}{\pi\sqrt{2}} \left[\int_0^\infty \frac{\sqrt{x}}{1+x^2} dx - \cos u \int_0^\infty \frac{e^{-ux} \sqrt{x}}{1+x^2} dx + \sin u \int_0^\infty \frac{e^{-ux}}{\sqrt{x}(1+x^2)} dx \right]. \end{aligned}$$

Now
$$\begin{aligned} \int_0^\infty \frac{\sqrt{x}}{1+x^2} dx &= \int_0^{\frac{\pi}{2}} \sqrt{\tan \theta} d\theta, \text{ by putting } x = \tan \theta, \\ &= \int_0^{\frac{\pi}{2}} (\sqrt{\tan \theta} + \sqrt{\cot \theta}) d\theta, \\ &= \frac{\pi}{\sqrt{2}}, \text{ by Ex. 8, p. 162, Vol I.} \end{aligned}$$

* Knochenhauer, *Die Undulationstheorie des Lichts*, p. 36; Preston, *Theory of Light*, p. 220.

† Cauchy, *Comptes Rendus*, tom. xv. 534, 573.

Hence

$$\left. \begin{aligned} \int_0^{\infty} \cos \frac{\pi v^2}{2} dv &= \frac{1}{2} - \cos \frac{\pi v^2}{2} \cdot \frac{1}{\pi\sqrt{2}} \int_0^{\infty} \frac{x^{\frac{1}{2}} e^{-ux}}{1+x^2} dx + \sin \frac{\pi v^2}{2} \frac{1}{\pi\sqrt{2}} \int_0^{\infty} \frac{x^{-\frac{1}{2}} e^{-ux}}{1+x^2} dx; \\ \text{and similarly} \\ \int_0^{\infty} \sin \frac{\pi v^2}{2} dv &= \frac{1}{2} - \cos \frac{\pi v^2}{2} \cdot \frac{1}{\pi\sqrt{2}} \int_0^{\infty} \frac{x^{-\frac{1}{2}} e^{-ux}}{1+x^2} dx - \sin \frac{\pi v^2}{2} \frac{1}{\pi\sqrt{2}} \int_0^{\infty} \frac{x^{\frac{1}{2}} e^{-ux}}{1+x^2} dx, \end{aligned} \right\}$$

where $u = \frac{\pi v^2}{2}$; which express Cauchy's series X' , Y' in the respective definite integral forms

$$X' \equiv \frac{1}{\pi\sqrt{2}} \int_0^{\infty} \frac{x^{\frac{1}{2}} e^{-ux}}{1+x^2} dx \quad \text{and} \quad Y' \equiv \frac{1}{\pi\sqrt{2}} \int_0^{\infty} \frac{x^{-\frac{1}{2}} e^{-ux}}{1+x^2} dx.$$

1176. Several other interesting relations amongst these integrals are given by Mr. Preston, to whose book the reader is referred.

A table of the values of Fresnel's integrals, as given by Gilbert, is quoted in Art. 1177 from Mr. Preston's book. The table is carried up to $v=5.0$. The oscillatory character of the results is exhibited in the graph of the Cornu Spiral in Art. 560.

1177. GILBERT'S TABLES OF FRESNEL'S INTEGRALS. Quoted from Preston's *Theory of Light*.

v	$\int_0^v \cos \frac{\pi v^2}{2} dv$	$\int_0^v \sin \frac{\pi v^2}{2} dv$	v	$\int_0^v \cos \frac{\pi v^2}{2} dv$	$\int_0^v \sin \frac{\pi v^2}{2} dv$
0.0	0.0000	0.0000	2.6	0.3389	0.5500
0.1	0.0999	0.0005	2.7	0.3926	0.4529
0.2	0.1999	0.0042	2.8	0.4675	0.3915
0.3	0.2994	0.0141	2.9	0.5624	0.4102
0.4	0.3975	0.0334	3.0	0.6057	0.4963
0.5	0.4923	0.0647	3.1	0.5616	0.5818
0.6	0.5811	0.1105	3.2	0.4663	0.5933
0.7	0.6597	0.1721	3.3	0.4057	0.5193
0.8	0.7230	0.2493	3.4	0.4385	0.4297
0.9	0.7648	0.3398	3.5	0.5326	0.4153
1.0	0.7799	0.4383	3.6	0.5880	0.4923
1.1	0.7638	0.5365	3.7	0.5419	0.5750
1.2	0.7154	0.6234	3.8	0.4481	0.5656
1.3	0.6386	0.6863	3.9	0.4223	0.4752
1.4	0.5431	0.7135	4.0	0.4984	0.4205
1.5	0.4453	0.6975	4.1	0.5737	0.4758
1.6	0.3655	0.6383	4.2	0.5417	0.5632
1.7	0.3238	0.5492	4.3	0.4494	0.5540
1.8	0.3363	0.4509	4.4	0.4383	0.4623
1.9	0.3945	0.3734	4.5	0.5258	0.4342
2.0	0.4883	0.3434	4.6	0.5672	0.5162
2.1	0.5814	0.3743	4.7	0.4914	0.5669
2.2	0.6362	0.4556	4.8	0.4338	0.4968
2.3	0.6268	0.5525	4.9	0.5002	0.4351
2.4	0.5550	0.6197	5.0	0.5636	0.4992
2.5	0.4574	0.6192	∞	0.5000	0.5000

1178. Soldner's Function.

The integral $y \equiv \int_0^x \frac{dx}{\log x}$ is known as Soldner's Integral. It is denoted by the symbol $\text{li}(x)$, which is Soldner's original notation. The letters li are suggested by the phrase 'logarithm-integral.'

It is obvious that the integrand has an infinity when $x=1$. Hence, in accordance with the theory of Principal Values (Chapter IX.), when the upper limit is greater than unity, we shall understand this integration to mean

$$\text{Lt}_{\epsilon=\eta=0} \left(\int_0^{1-\epsilon} + \int_{1+\eta}^x \right) \frac{dx}{\log x},$$

where ϵ, η are made to diminish indefinitely in a ratio of equality.

1179. Properties of the Function.

It follows that $\frac{d}{dx} \text{li}(x) = \frac{1}{\log x}$. Hence

$$\begin{aligned} \frac{d}{dx} \text{li}(x^{m+1}) &= \frac{(m+1)x^m}{\log x^{m+1}} = \frac{x^m}{\log x}, & \frac{d}{dx} \text{li}(a+bx) &= \frac{b}{\log(a+bx)}, \\ \frac{d}{dx} \text{li}(e^x) &= \frac{e^x}{\log e^x} = \frac{e^x}{x}, & \frac{d}{dx} \text{li}(e^{-x}) &= \frac{-e^{-x}}{\log e^{-x}} = \frac{e^{-x}}{x}, \\ \frac{d}{dx} \text{li}(e^{a+x}) &= \frac{e^a e^x}{\log e^{a+x}} = \frac{e^a e^x}{a+x}, & \frac{d}{dx} \text{li}(\sin x) &= \frac{\cos x}{\log \sin x}, \text{ etc.} \end{aligned}$$

Hence conversely we may express certain integrals in terms of a Soldner's function, viz.

$$\begin{aligned} \int \frac{x^m}{\log x} dx &= \text{li}(x^{m+1}) + C, \quad \text{or between limits } \int_b^a \frac{x^m}{\log x} dx = \text{li}(a^{m+1}) - \text{li}(b^{m+1}), \\ \int \frac{dx}{\log(a+bx)} &= \frac{\text{li}(a+bx)}{b} + C, \quad \text{or between limits } \int_{p_1}^{p_2} \frac{dx}{\log(a+bx)} = \frac{\text{li}(a+bp_2) - \text{li}(a+bp_1)}{b}, \\ \int \frac{e^x}{x} dx &= \text{li}(e^x) + C, \quad \text{i.e. } \int_b^a \frac{e^x}{x} dx = \text{li}(e^a) - \text{li}(e^b), \text{ and so on.} \end{aligned}$$

1180. To enable the arithmetical calculations of such results to be made, Soldner constructed a table of the values of $\text{li}(x)$ to seven decimal places for values of x , from $x=0.00$ to $x=1.00$, at the latter of which the function is infinite, the values being negative; and a further table of the values of $\text{li} x$, giving the values to seven places, for $x=1, 1.1, 1.2, 1.3, 1.4$, which are negative, and $1.5, 1.6, \dots, 2, 2.5, 3, 4, 5, \dots, 20$, which are positive, and at certain intervals from 22 to 1220, all taken to eight significant figures.

It is unnecessary to give the tables here. They will be found reproduced in De Morgan's *Diff. and Int. Calculus*, pages 662 and 663. A few extracts from these tables will indicate the shape of the graph :

x	$\ln(x) (-)$	x	$\ln(x) (-)$	x	$\ln(x) (-)$
·00	·000	·60	·547	1·0	∞
·05	·013	·70	·781	1·1	1·676
·10	·032	·80	1·134	1·2	0·934
·15	·056	·90	1·776	1·3	0·480
·20	·085	·95	2·444	1·4	0·145
·25	·119	·98	3·345		
·30	·157	·99	4·033		
·40	·253	1·00	∞		
·50	·379				

x	$\ln(x) (+)$	x	$\ln(x) (+)$
1·5	0·125	20·0	9·905
1·6	0·354	30·0	13·023
1·8	0·733	40·0	15·840
2·0	1·045	100·0	30·126
2·5	1·667	200·0	50·192
3·0	2·164	400·0	85·4
4·0	2·968	600	117·6
5·0	3·635	1040	183·4
10·0	6·166	1220	217·4

The march of the function can then be seen to be as represented by the accompanying graph.

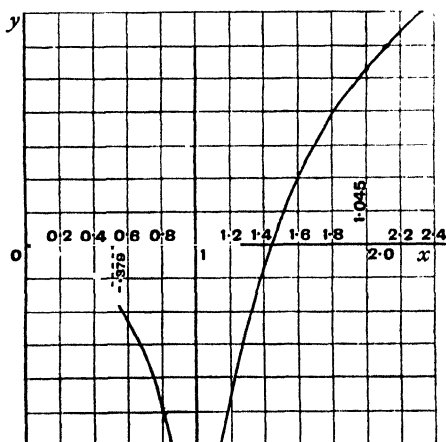

Fig. 338.

1181. Method of Computation.

We proceed to show how these values were computed.

It will be seen that, by putting $x=e^{-v}$ or $x=e^v$, the integral $\int_0^a \frac{dx}{\log x}$ can be thrown into the forms $-\int_{-\log a}^{\infty} \frac{e^{-v} dv}{y}$ or $\int_{-\infty}^{\log a} \frac{e^v dv}{y}$.

Now, so long as n is greater than zero, we have by expansion

$$\int_v^{\infty} x^{n-1} e^{-x} dx = \int_v^{\infty} x^{n-1} \left(1 - \frac{x}{1!} + \frac{x^2}{2!} - \frac{x^3}{3!} + \dots\right) dx$$

$$= C - \frac{v^n}{n} + \frac{v^{n+1}}{(n+1)1!} - \frac{v^{n+2}}{(n+2)2!} + \frac{v^{n+3}}{(n+3)3!} - \dots,$$

where C is to be found. The series is convergent for all positive values of v and does not become infinite with v . Also, when $v=0$, the value of the integral is $\Gamma(n)$. Hence $C=\Gamma(n)$.

Hence $\int_v^{\infty} x^{n-1} e^{-x} dx = \Gamma(n) - \frac{v^n}{n} + \frac{v^{n+1}}{(n+1)1!} - \frac{v^{n+2}}{(n+2)2!} + \dots$

This may be arranged as

$$\int_v^{\infty} x^{n-1} e^{-x} dx = \Gamma(n) - \frac{1}{n} \frac{v^n - 1}{n} + \frac{v^{n+1}}{(n+1)1!} - \frac{v^{n+2}}{(n+2)2!} + \dots$$

$$= \frac{\Gamma(n+1) - 1}{n} - \frac{v^n - 1}{n} + \frac{v^{n+1}}{(n+1)1!} - \dots, \text{ etc.}$$

Now, if we make n diminish indefinitely, $Lt \frac{v^n - 1}{n} = \log v$, and $Lt \frac{\Gamma(n+1) - 1}{n}$ is the limit, when $n=0$, of $\frac{\Gamma(x+n) - \Gamma(x)}{n}$ for the value $x=1$, i.e.

$$\left[\frac{d}{dx} \Gamma(x) \right]_{x=1} \text{ or } \Gamma'(1),$$

or as $\Gamma(1)=1$, this is the same as $\left[\frac{d}{dx} \log \Gamma(x) \right]_{x=1}$, i.e. $-\gamma$, where γ is Euler's Constant.

Hence $\int_v^{\infty} \frac{e^{-x}}{x} dx = -\gamma - \log v + \frac{v}{1 \cdot 1!} - \frac{v^2}{2 \cdot 2!} + \frac{v^3}{3 \cdot 3!} - \dots, \dots\dots(A)$

Hence we have, putting $v = \log a$,

$$\text{li}\left(\frac{1}{a}\right) = -\int_{\log a}^{\infty} \frac{e^{-x}}{x} dx = \gamma + \log(\log a) - \frac{\log a}{1 \cdot 1!} + \frac{(\log a)^2}{2 \cdot 2!} - \frac{(\log a)^3}{3 \cdot 3!} + \dots \quad (a > 1), \dots\dots(B)$$

Again, by expansion,

$$-\int_{-\log a}^{-\epsilon} \frac{e^{-x}}{x} dx = \log\left(\frac{\log a}{\epsilon}\right) + \frac{\log a - \epsilon}{1 \cdot 1!} + \frac{(\log a)^2 - \epsilon^2}{2 \cdot 2!} + \dots \quad (a > 1)$$

and $-\int_{\eta}^{\infty} \frac{e^{-x}}{x} dx = \gamma + \log \eta - \frac{\eta}{1 \cdot 1!} + \frac{\eta^2}{2 \cdot 2!} - \dots,$

and upon addition, diminishing ϵ and η indefinitely in a ratio of equality, the Principal Value of $\text{li}(a)$ is given by

$$\text{li}(a) = -\int_{-\log a}^{\infty} \frac{e^{-x}}{x} dx = -Lt\left(\int_{-\log a}^{-\epsilon} + \int_{\eta}^{\infty}\right) \frac{e^{-x}}{x} dx, \text{ where } \epsilon = \eta = 0,$$

$$= \gamma + \log(\log a) + \frac{\log a}{1 \cdot 1!} + \frac{(\log a)^2}{2 \cdot 2!} + \frac{(\log a)^3}{3 \cdot 3!} + \dots \quad (a > 1). \dots\dots(C)$$

As there is manifest discontinuity when $a=1$, and the Principal Value is taken in integrating over the discontinuity in the second case, formula (C) will not be derivable from formula (B) by putting $\frac{1}{a}$ for a in the former. It will be observed, however, that the two series then only differ by $\log(-1)$, which is the effect of the discontinuity.

By means of the expansion of

$$\frac{1}{\log(1+x)} = \frac{1}{x} \frac{1}{1 - \frac{x}{2} + \frac{x^2}{3} - \dots}$$

$$= x^{-1} + K_1 + K_2x + K_3x^2 + K_4x^3 + \dots,$$

where the coefficients may be calculated either by actual division or by multiplying up by $x(1 - \frac{x}{2} + \dots)$ and equating coefficients, giving

$$K_1 = \frac{1}{2}, \quad K_2 = -\frac{1}{12}, \quad K_3 = \frac{1}{24}, \quad K_4 = -\frac{1}{720}, \quad K_5 = \frac{1}{360}, \quad K_6 = -\frac{1}{8640}, \text{ etc.,}$$

we have, $a < 1$,

$$\text{li}(1-a) = \int_0^{1-a} \frac{dz}{\log z} = \int_{-1}^{-a} \frac{dx}{\log(1+x)} = \log a - K_1(a-1) + \frac{1}{2}K_2(a^2-1) - \text{etc.};$$

and by Art. 944, putting $e^{-\beta} = v$,

$$\gamma = \text{Lt}_{b \rightarrow 1} \left\{ \int_0^b \frac{dv}{1-v} + \int_0^b \frac{dv}{\log v} \right\}$$

$$= \text{Lt}_{b \rightarrow 1} \{ \text{li } b - \log(1-b) \} = \text{Lt}_{a \rightarrow 0} \{ \text{li}(1-a) - \log a \} = K_1 - \frac{K_2}{2} + \frac{K_3}{3} - \dots,$$

whence $\text{li}(1-a) = \gamma + \log a - K_1a + \frac{K_2}{2}a^2 - \dots$ (D)

Again $\text{li}(1+a) = \text{Prin. Val. of } \int_0^{1+a} \frac{dz}{\log z} = \text{P.V. of } \int_{-1}^a \frac{dz}{\log(1+z)}$

$$= \text{Lt}_{\epsilon \rightarrow 0} \left(\int_{-1}^{-\epsilon} + \int_{\epsilon}^a \right) \frac{dz}{\log(1+z)}$$

$$= \text{Lt}_{\epsilon \rightarrow 0} [(\gamma + \log \epsilon - K_1\epsilon + \frac{1}{2}K_2\epsilon^2 - \dots)]$$

$$+ \{ \log a - \log \epsilon + K_1(a-\epsilon) + \frac{1}{2}K_2(a^2-\epsilon^2) + \dots \};$$

$$\therefore \text{li}(1+a) = \gamma + \log a + K_1a + K_2\frac{a^2}{2} + \dots$$
(E)

Also, by Taylor's Theorem,

$$\text{li}(a+x) = \text{li}(a) + x(\log a)^{-1} + \frac{d}{da}(\log a)^{-1} \frac{x^2}{2!} + \frac{d^2}{da^2}(\log a)^{-1} \frac{x^3}{3!} + \dots$$

Other results will be found in De Morgan's *Differential and Int. Calc.*, pages 660 to 664. By aid of these series Soldner calculated the numerical values of the table for the function $\text{li}(a) \equiv \int_0^a \frac{dx}{\log x}$.

We may therefore now regard such functions as

$$\frac{1}{\log x}, \quad \frac{x^m}{\log x}, \quad \frac{e^x}{x}, \quad \frac{\cosh x}{x}, \quad \frac{e^x}{x+a}, \text{ etc.,}$$

as integrable in terms of Soldner's function, and therefore their integrals calculable by means of his table, for assigned values of the limits.

1182. FRULLANI'S THEOREM: ELLIOTT'S AND LEUDESORF'S EXTENSIONS.

Suppose $F(xy)$ a function of the product xy of the coordinates of a point in the plane of x, y lying in the region bounded by the y -axis, an ordinate at infinity and the two straight lines $y=a$ and $y=b$ parallel to the x -axis. Let a and b be supposed of the same sign. Let $F(z)$ and $F'(z)$, where $z=xy$, be finite and continuous functions for all points in this region and also along the boundaries.

Suppose also that $F(xy)$ takes definite finite values at $x=0$ and at $x=\infty$ from the value $y=b$ to $y=a$ inclusive, and

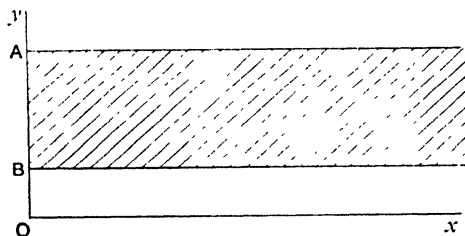

FIG. 339.

denote them by $F(0)$ and $F(\infty)$ respectively. Consider the surface integral of $F'(xy)$ over this region. This is expressed by

$$\int_0^{\infty} \int_b^a F'(xy) dx dy, \text{ or, what is the same thing, } \int_b^a \int_0^{\infty} F'(xy) dy dx.$$

The first form of the integral is

$$= \int_0^{\infty} \left[\frac{F(xy)}{x} \right]_{y=b}^{y=a} dx = \int_0^{\infty} \frac{F(ax) - F(bx)}{x} dx.$$

The second form of the integral is

$$\begin{aligned} &= \int_b^a \left[\frac{F(xy)}{y} \right]_{x=0}^{x=\infty} dy = [F(\infty) - F(0)] \int_b^a \frac{dy}{y} \\ &= [F(\infty) - F(0)] \log \frac{a}{b}. \end{aligned}$$

Hence it appears that

$$\int_0^{\infty} \frac{F(ax) - F(bx)}{x} dx = [F(\infty) - F(0)] \log \frac{a}{b}. \dots\dots\dots(1)$$

Similarly, if we integrate over the region bounded by

$$x = -\infty, \quad x = 0, \quad y = a, \quad y = b,$$

we obtain in the same manner

$$\int_{-\infty}^0 \frac{F(ax) - F(bx)}{x} dx = [F(0) - F(-\infty)] \log \frac{a}{b}, \dots \dots (2)$$

provided $F(xy)$ takes a definite value $F(-\infty)$ at $x = -\infty$.

In cases where $F(\infty) = 0$ or $F(0) = 0$ the theorem takes the simpler forms $\int_0^{\infty} \frac{F(ax) - F(bx)}{x} dx = F(0) \log \frac{b}{a}$ or $F(\infty) \log \frac{a}{b}$ respectively.

1183. We may examine these results from another point of view.

Let $u \equiv \int_0^h \frac{F(ax) - F(0)}{x} dx$. Then, putting $ax = y$, $\frac{dx}{x} = \frac{dy}{y}$, and $u = \int_0^h \frac{F(y) - F(0)}{y} dy$, and is therefore independent of a .

$$\begin{aligned} \text{Hence } \int_0^h \frac{F(ax) - F(0)}{x} dx &= \int_0^h \frac{F(bx) - F(0)}{x} dx \\ &= \int_0^h \frac{F(bx)}{x} dx - \int_h^a \frac{F(bx)}{x} dx - \int_0^h \frac{F(0)}{x} dx. \end{aligned}$$

$$\begin{aligned} \text{Therefore } \int_0^h \frac{F(ax) - F(bx)}{x} dx + \int_h^a \frac{F(bx)}{x} dx &= F(0) \int_h^a \frac{dx}{x} \\ &= F(0) \log \frac{b}{a}. \end{aligned}$$

Now, in the second integral, viz. $\int_h^a \frac{F(bx)}{x} dx$, both limits become infinite, when h is indefinitely increased, but they are separated by an infinite interval $\frac{h}{a} - \frac{h}{b} = \frac{b-a}{ab} h$. Hence it cannot be assumed that this integral vanishes, and it must be investigated in each case.

If, however, $F(bx)$ tends to take a definite finite value $F(\infty)$ when x is increased indefinitely, let its value between the limits $\frac{h}{b}$ and $\frac{h}{a}$ be called $F(\infty) + \epsilon$, where ϵ is ultimately an

infinitesimal, and let ϵ_1 and ϵ_2 be the greatest and least values of ϵ for values of x between $\frac{h}{b}$ and $\frac{h}{a}$. Thus $\int_{\frac{h}{b}}^{\frac{h}{a}} \frac{F(bx)}{x} dx$ lies between

$$(F(\infty) + \epsilon_1) \log \frac{b}{a} \quad \text{and} \quad (F(\infty) + \epsilon_2) \log \frac{b}{a},$$

and therefore in the limit becomes $F(\infty) \log \frac{b}{a}$, and the theorem becomes

$$\int_0^{\infty} \frac{F(ax) - F(bx)}{x} dx = [F(\infty) - F(0)] \log \frac{a}{b}.$$

But supposing $F(bx)$ not to take up a definite limiting value such as has been described, it may still happen that

$\lim_{h \rightarrow \infty} \int_{\frac{h}{b}}^{\frac{h}{a}} \frac{F(bx)}{x} dx$ assumes a definite value $-K$, or it may vanish.

$$\text{In the former case} \quad \int_0^{\infty} \frac{F(ax) - F(bx)}{x} dx = K - F(0) \log \frac{a}{b}.$$

$$\text{In the latter case} \quad \int_0^{\infty} \frac{F(ax) - F(bx)}{x} dx = F(0) \log \frac{b}{a}.$$

The formula $\int_0^{\infty} \frac{F(ax) - F(bx)}{x} dx = F(0) \log \frac{b}{a}$ is known as

Frullani's Theorem. According to Dr. Williamson it was communicated by Frullani to Plana in 1821, and subsequently published in *Mem. del. Soc. Ital.*, 1828.

The more general form

$$\int_0^{\infty} \frac{F(ax) - F(bx)}{x} dx = [F(\infty) - F(0)] \log \frac{a}{b}$$

is due to Prof. E. B. Elliott (*Educational Times*, 1875).*

1184. As examples we may take

$$1. \int_0^{\infty} \frac{\tan^{-1}ax - \tan^{-1}bx}{x} dx = (\tan^{-1}\infty - \tan^{-1}0) \log \frac{a}{b} = \frac{\pi}{2} \log \frac{a}{b}.$$

$$2. \int_0^{\infty} \log \frac{p + qe^{-ax}}{p + qe^{-bx}} \frac{dx}{x} = (\log p - \log(p+q)) \log \frac{a}{b} = \log \left(1 + \frac{q}{p}\right) \log \frac{b}{a}.$$

These two examples are given by Bertrand, but arrived at in a different manner.

* Both references are due to Prof. Williamson, pages xi and 156, *Int. Calc.*

3. $\int_0^\infty \left[\left(\frac{ax+p}{ax+q} \right)^n - \left(\frac{bx+p}{bx+q} \right)^n \right] \frac{dx}{x} = \left(1 - \frac{p^n}{q^n} \right) \log \frac{a}{b}$, a, b, p, q being positive quantities.

4. $\int_0^\infty \frac{\cos ax - \cos bx}{x} dx = \log \frac{b}{a}$, which has been discussed earlier (Art. 1041).

1185. It will be observed by reference to the article cited that in Ex. 4 the second mode of discussion was adopted. This was necessary, for if we attempt to apply Prof. Elliott's extension the debateable value $\cos \infty$ appears.

As to the values of $\cos \infty$ and $\sin \infty$, which we have in all cases avoided, the student may refer to a remark of Todhunter, *Int. Calc.*, p. 278, and may also consult Memoirs XV., XIX., XXXII. in Vol. VIII. *Camb. Phil. Trans.*, there referred to.

In cases where the evaluation of $\int_0^\infty \frac{F(ax) - F(bx)}{x} dx$ involves any doubt as to the definiteness of the value of $F(xy)$, when x becomes infinite, or doubt as to the evaluation of the limit $\lim_{h \rightarrow \infty} \int_h^h \frac{F(bx)}{x} dx$, another method of investigation must be adopted.

5. Thus, in the case

$$\int_0^\infty \log \left(\frac{1 + 2n \cos ax + n^2}{1 + 2n \cos bx + n^2} \right) \frac{dx}{x},$$

we may write the integral (by Art. 1134) as

$$\int_0^\infty 2 \sum_1^\infty \frac{(-1)^{r-1}}{r} n^r \left(\frac{\cos rax - \cos rbx}{x} \right) dx, \quad (n^2 < 1),$$

$$\text{or } \int_0^\infty 2 \sum_1^\infty \frac{(-1)^{r-1}}{r} \frac{1}{n^r} \left(\frac{\cos rax - \cos rbx}{x} \right) dx, \quad (n^2 > 1),$$

$$= 2 \log \frac{b}{a} \sum_1^\infty (-1)^{r-1} \frac{n^r}{r}, \quad (n^2 < 1); \quad \text{or } 2 \log \frac{b}{a} \sum_1^\infty (-1)^{r-1} \frac{1}{rn^r}, \quad (n^2 > 1);$$

$$= \log \frac{b}{a} \log(1+n)^2, \quad (n^2 < 1); \quad \text{or } \log \frac{b}{a} \cdot \log \left(1 + \frac{1}{n} \right)^2, \quad (n^2 > 1).$$

1186. In cases where $F(\infty)$ and $F(0)$ both vanish, the result is of course zero.

$$\text{Thus, } \int_0^\infty \frac{e^{-ax} \sin ax - e^{-bx} \sin bx}{x} dx = 0.$$

$$\text{But } \int_0^\infty \frac{e^{-ax} \cos ax - e^{-bx} \cos bx}{x} dx = \log \frac{b}{a}.$$

1187. **Other forms of the general result** may be obtained by transformation.

Thus, replacing x by x^n ,

$$\int_0^\infty \frac{F(ax^n) - F(bx^n)}{x} dx = \frac{1}{n} \int_0^\infty \frac{F(ax) - F(bx)}{x} dx = \frac{1}{n} [F(\infty) - F(0)] \log \frac{a}{b},$$

$$\int_n^\infty \frac{F(a\sqrt{x}) - F(b\sqrt{x})}{x} dx = [F(\infty) - F(0)] \log \frac{a^2}{b^2}.$$

Or again, putting $y = \log x$, the formulae

$$\int_0^{\infty} \frac{F(ay) - F(by)}{y} dy = \{F(\infty) - F(0)\} \log \frac{a}{b},$$

$$\int_{-\infty}^0 \frac{F(ay) - F(by)}{y} dy = \{F(0) - F(-\infty)\} \log \frac{a}{b},$$

respectively become

$$\int_1^{\infty} \frac{F(\log x^a) - F(\log x^b)}{\log x} \cdot \frac{dx}{x} = \{F(\log \infty) - F(\log 1)\} \log \frac{a}{b},$$

and $\int_0^1 \frac{F(\log x^a) - F(\log x^b)}{\log x} \cdot \frac{dx}{x} = \{F(\log 1) - F(\log 0)\} \log \frac{a}{b};$

and, writing $F(\log z) \equiv f(z)$,

$$\int_1^{\infty} \frac{f(x^a) - f(x^b)}{\log x} \frac{dx}{x} = \{f(\infty) - f(1)\} \log \frac{a}{b},$$

and $\int_0^1 \frac{f(x^a) - f(x^b)}{\log x} \frac{dx}{x} = \{f(1) - f(0)\} \log \frac{a}{b}. \quad [\text{ELLIOTT.}]$

Again, if we write $a = e^{\alpha}$, $b = e^{\beta}$, $x = e^y$; $x = 0$ gives $y = -\infty$, $x = \infty$ gives $y = \infty$, and if $F(e^z)$ be replaced by $f(z)$, we have

$$\int_{-\infty}^{\infty} \frac{F(e^{\alpha} e^y) - F(e^{\beta} e^y)}{e^y} e^y dy = [F(e^{\alpha} e^y)_{y=\infty} - F(e^{\beta} e^y)_{y=-\infty}] \log \frac{a}{b},$$

i. e. $\int_{-\infty}^{\infty} [f(\alpha + y) - f(\beta + y)] dy = [f(\infty) - f(-\infty)] \log \frac{a}{b}$
 $= [f(\infty) - f(-\infty)] (\alpha - \beta). \quad [\text{ELLIOTT.}]$

1188. Elliott's Extension to Multiple Integrals.

Professor Elliott has extended the general form of Frullani's Theorem to the case of certain Multiple Integrals in two papers in Vol. VIII. of the *Proceedings of the London Mathematical Society*, and a supplementary paper on these extensions was published by Mr. Leudesdorf in Vol. IX. of the same Journal. The singular elegance of the results arrived at will commend itself to the attention of the advanced student who should consult the original papers. We have no space here for more than a brief indication of the method followed.

Adopting the notation used by Mr. Leudesdorf, let $S(p, q)$ denote any symmetric function of p, q which does not become infinite for any positive values of p, q from 0 to ∞ inclusive. Denote

$$\int_0^{\infty} \frac{S(ax)}{x} dx \text{ by } [a], \quad \int_0^{\infty} \int_0^{\infty} S(ax, by) \frac{dx dy}{xy} \text{ by } [a, b].$$

Let $a = e^{\alpha}$, $b = e^{\beta}$, $c = e^{\gamma}$, $d = e^{\delta}$.

Then Elliott's form of Frullani's Theorem may be written

$$[a] - [b] = [S(\infty) - S(0)] (\alpha - \beta).$$

Now, consider the integral $[ac] - [bc] - [ad] + [bd]$, or, as it may be written for short, $[(a-b)(c-d)]$.

By two applications of the above theorem this becomes

$$\begin{aligned} & \int_0^{\infty} \int_0^{\infty} [S(ax, cy) - S(bx, cy) - S(ax, dy) + S(bx, dy)] \frac{dx dy}{xy} \\ &= \int_0^{\infty} (a-\beta) [S(\infty, cy) - S(0, cy)] \frac{dy}{y} - \int_0^{\infty} (a-\beta) [S(\infty, dy) - S(0, dy)] \frac{dy}{y} \\ &= (a-\beta) \int_0^{\infty} [S(\infty, cy) - S(\infty, dy)] \frac{dy}{y} - (a-\beta) \int_0^{\infty} [S(0, cy) - S(0, dy)] \frac{dy}{y} \\ &= (a-\beta)(\gamma-\delta) [S(\infty, \infty) - S(\infty, 0)] - (a-\beta)(\gamma-\delta) [S(0, \infty) - S(0, 0)], \end{aligned}$$

and as S is a symmetric function $S(\infty, 0) = S(0, \infty)$.

Hence, we obtain

$$(a-\beta)(\gamma-\delta) [S(\infty, \infty) - 2S(\infty, 0) + S(0, 0)],$$

which, for short, may be written $(a-\beta)(\gamma-\delta)S(\infty-0)^2$.

Hence, the extension to a double integral may be written

$$[(a-b)(c-d)] = S(\infty-0)^2(a-\beta)(\gamma-\delta).$$

In the papers cited, the result is extended to multiple integrals of a higher order. The student should have no difficulty in doing this for himself.

1189. On the Transition from Real Constants to Complex Constants in Results of Differentiation and Integration.

Let us premise that, in the remarks following, the variable is a real one, viz. x , that the path of integration is along a portion of the x -axis, that the limits of any integrals occurring are real quantities, and that the constants occurring are independent of the limits; also that the functions dealt with are finite and continuous, and such as to possess differential coefficients.

1190. Lemma I.

Let u_1 and u_2 be two real functions of x which continually approach to and ultimately differ by less than any assignable quantities from definite limiting values v_1 and v_2 respectively as x continually approaches a definite value a . We may then put $u_1 = v_1 + \epsilon_1$ and $u_2 = v_2 + \epsilon_2$, where ϵ_1 and ϵ_2 are quantities which ultimately vanish when x approaches indefinitely closely to a , so that $\epsilon_1 + i\epsilon_2$ also ultimately vanishes, where i stands for $\sqrt{-1}$.

Then

$$u_1 + iu_2 = v_1 + iv_2 + \epsilon_1 + i\epsilon_2$$

and $Lt(u_1 + iu_2) = v_1 + iv_2 + Lt(\epsilon_1 + i\epsilon_2) = v_1 + iv_2 = Lt u_1 + i Lt u_2$.

1191. Lemma II.

If, upon putting $x+h$ for x , u_1 and u_2 take the values U_1 and U_2 respectively, it follows that $u_1 + iu_2$ takes the value $U_1 + iU_2$, and therefore

$$Lt_{h=0} \frac{(U_1 + iU_2) - (u_1 + iu_2)}{h} = Lt \frac{U_1 - u_1}{h} + i Lt \frac{U_2 - u_2}{h},$$

i.e.

$$\frac{d}{dx} (u_1 + iu_2) = \frac{du_1}{dx} + i \frac{du_2}{dx}.$$

Hence, when a function of x containing a complex constant $p+iq$, but no other unreal quantity, can be separated into its real and imaginary parts as

$$F(x, p+iq) = F_1(x, p, q) + iF_2(x, p, q),$$

then
$$\frac{d}{dx} F(x, p+iq) = \frac{d}{dx} F_1(x, p, q) + i \frac{d}{dx} F_2(x, p, q).$$

1192. It has been desirable to consider these results in detail, though they might be thought obvious. For in our idea of a limit we have had constantly in mind some real quantitative arithmetical or algebraical result from which the function under consideration could be made to differ by less than any assignable real quantity by making the variable approach nearer and nearer to its assigned value; and it has not hitherto been necessary to consider the case where the function involves unreal constants.

1193. It is well known that the separation of a complex function into its real and imaginary parts can be effected in all the ordinary cases when the function is of algebraic, exponential, logarithmic, circular or hyperbolic or inverse circular or inverse hyperbolic form, such as

$(p+iq)^n$, $(p+iq)^{a+ib}$, a^{p+iq} , $\log(p+iq)$, $\sin(p+iq)$, $\tan^{-1}(p+iq)$, etc., as well as in any combination of such functions.

Lemma III. If $F(z)$ be any function of z expressible as a power series with real coefficients, viz. $F(z) \equiv \sum A_n z^n$, with radius of convergence ρ , then $F(p+iq) = \sum A_n (p+iq)^n = \sum A_n r^n e^{n i \theta}$, where $r = \sqrt{p^2+q^2} < \rho$, $\theta = \tan^{-1} q/p$
 $= X + iY$, say,

where $X = \sum A_n r^n \cos n\theta$, $Y = \sum A_n r^n \sin n\theta$, and both these series are convergent if $\sum A_n r^n$ be convergent, and then $X + iY$ is convergent.

We then have $X - iY = \sum A_n r^n e^{-n i \theta} = \sum A_n (p-iq)^n = F(p-iq)$.

The separation into real and imaginary parts is then effected by addition and subtraction of the equations

$$X + iY = F(p+iq), \quad X - iY = F(p-iq),$$

giving $2X = F(p+iq) + F(p-iq)$, $2iY = F(p+iq) - F(p-iq)$.

1194. **Lemma IV.**

When $F(x, p+iq)$ can be thus separated into real and unreal parts, as

$$F(x, p+iq) = F_1(x, p, q) + iF_2(x, p, q),$$

F_1 and F_2 , besides containing x , may be regarded as conjugate functions of p and q , and therefore

$$\frac{\partial F_1}{\partial p} = \frac{\partial F_2}{\partial q}, \quad \frac{\partial F_1}{\partial q} = -\frac{\partial F_2}{\partial p};$$

and differentiating with regard to x ,

$$\frac{\partial}{\partial p} \left(\frac{dF_1}{dx} \right) = \frac{\partial}{\partial q} \left(\frac{dF_2}{dx} \right), \quad \frac{\partial}{\partial q} \left(\frac{dF_1}{dx} \right) = -\frac{\partial}{\partial p} \left(\frac{dF_2}{dx} \right),$$

i.e. $\frac{dF_1}{dx}$ and $\frac{dF_2}{dx}$ are also conjugate functions of p and q ;

i.e. $\frac{dF}{dx}$, which is equal to $\frac{dF_1}{dx} + \iota \frac{dF_2}{dx}$, besides involving x , involves p and q as a function of $p + \iota q$, and $\equiv \phi(x, p + \iota q)$, say.

It might be said that this also is a self-evident fact arising from the principle that the process of differentiation with regard to x takes no cognisance of the particular values of any constants involved. But as our experience of this fact is based upon the behaviour of functions containing only real constants, it is desirable at this stage to make this point also clear and to establish it explicitly.

We have then $\frac{d}{dx} F(x, p + \iota q)$ of the form $\phi(x, p + \iota q)$ for all real values of x , p and q , and we have to identify the form of this function ϕ .

Now the *form* of a function is merely a means of defining the *particular manner in which the several variables and constants are involved* in its construction, and is independent of any particular values assignable to those variables and constants.

Suppose then that it has been discovered in the case of a real constant p that $\frac{d}{dx} F(x, p)$ takes the form $f(x, p)$, a known form say, for all values of x and p ; then since, when $q=0$ we also have $\frac{d}{dx} F(x, p) = \phi(x, p)$ for all values of x and p , we must have $\phi(x, p) \equiv f(x, p)$; that is, the form of the function ϕ is identified as being the same functional form as that obtained in the differentiation of $F(x, p)$ for a real value of p .

1195. It is assumed in what precedes that we are dealing with a function $F(x, p)$ which is continuous and finite for the whole of some range of values of x within which x lies, whatever real value p may have, and that the differentiation of F with regard to x is a possible operation; and that these suppositions will not be affected if we change p to $p + \iota q$. Further, that F_1 and F_2 are continuous and finite functions of x for the same range, and that differentiation with regard to x , p or q is a possible operation. Under these circumstances we may infer that if

$$\frac{d}{dx} F(x, p) = f(x, p),$$

where p is a real constant, we shall also have a result of the same form when p is a complex constant.

If then it be distinctly understood that the *definition of integration* used is that it is the *reversal of the operation of differentiation*, i.e. the discovery of a function $F(x, p + \iota q)$, which upon differentiation with regard to x shall give rise to a stated result $f(x, p + \iota q)$, it will follow *under the limitations stated above*, that if $\int f(x, p) dx = F(x, p)$, where p is a real constant, we shall also have $\int f(x, p + \iota q) dx = F(x, p + \iota q)$, where $p + \iota q$ is a complex constant, and the integrals being indefinite a real arbitrary constant C may be supposed added in the first case, and a complex arbitrary constant $C_1 + \iota C_2$ in the second.

1196. As examples of these facts, let us consider

(1) the differentiation of x^{p+iq} , where p and q are here, as always, real.

We have

$$\begin{aligned} \frac{d}{dx} x^{p+iq} &= \frac{d}{dx} (x^p e^{iq \log x}) = \frac{d}{dx} [x^p \{\cos(q \log x) + i \sin(q \log x)\}] \\ &= \frac{d}{dx} [x^p \{\cos(q \log x)\}] + i \frac{d}{dx} [x^p \{\sin(q \log x)\}], \text{ by Lemma II.,} \\ &= \left[p x^{p-1} \cos(q \log x) + x^p \left(-\frac{q}{x} \right) \sin(q \log x) \right] \\ &+ i \left[p x^{p-1} \sin(q \log x) + x^p \left(\frac{q}{x} \right) \cos(q \log x) \right] \\ &= (p+iq) x^{p-1} [\cos(q \log x) + i \sin(q \log x)] = (p+iq) x^{p-1} e^{iq \log x} \\ &= (p+iq) x^{p+iq-1}, \end{aligned}$$

as might be expected from the principle of permanence of form stated above.

Hence the rule $\frac{d}{dx} x^n = n x^{n-1}$ holds whether n be real or complex.

Conversely,
$$\int x^{p+iq-1} dx = \frac{x^{p+iq}}{p+iq},$$

and therefore the rule for integration, viz. $\int x^{n-1} dx = \frac{x^n}{n}$, also holds whether the index n be real or complex.

(2) Consider $\frac{d}{dx} a^{(p+iq)x}$.

$$\begin{aligned} \text{This is } \frac{d}{dx} e^{px \log a} [\cos(qx \log a) + i \sin(qx \log a)] \\ &= \frac{d}{dx} e^{px \log a} \cos(qx \log a) + i \frac{d}{dx} e^{px \log a} \sin(qx \log a) \\ &= (p+iq) \log a e^{px \log a} [\cos(qx \log a) + i \sin(qx \log a)] \\ &= (p+iq) \log a \cdot a^{(p+iq)x}, \end{aligned}$$

which is the ordinary rule for differentiating a^{nx} when n is real.

Hence $\frac{d}{dx} a^{nx} = n \log a \cdot a^{nx}$ whether n be real or complex, and conversely

$$\int a^{nx} dx = \frac{a^{nx}}{n \log a} \text{ whether } n \text{ be real or complex.}$$

(3) Consider $\frac{d}{dx} \log_{p+iq} x$,

i.e.
$$\frac{d}{dx} \frac{\log_e x}{\log_e(p+iq)} = \frac{1}{\log_e(p+iq)} \frac{d}{dx} \log_e x = \frac{1}{x} \cdot \frac{1}{\log_e(p+iq)},$$

which is again the ordinary rule for $\frac{d}{dx} \log_a x$, viz. $\frac{1}{x} \cdot \frac{1}{\log_e a}$.

(4) Consider $\frac{d}{dx} \tan^{-1} \frac{x}{p+iq}$.

Let $\tan^{-1} \frac{x}{p+iq} = X - iY$, and therefore $\tan^{-1} \frac{x}{p-iq} = X + iY$.

$$\text{Then } 2X = \tan^{-1} \frac{2px}{p^2 + q^2 - x^2}, \quad 2Y = \tanh^{-1} \frac{2qx}{p^2 + q^2 + x^2},$$

$$\text{and } \frac{dX}{dx} - \iota \frac{dY}{dx} = p \frac{p^2 + q^2 + x^2}{(p^2 + q^2 - x^2)^2 + 4p^2x^2} - \iota q \frac{p^2 + q^2 - x^2}{(p^2 + q^2 + x^2)^2 - 4q^2x^2}.$$

But since

$$(p^2 + q^2 - x^2)^2 + 4p^2x^2 = (p^2 + q^2 + x^2)^2 - 4q^2x^2 = (p^2 - q^2 + x^2)^2 + 4p^2q^2,$$

$$\begin{aligned} \text{we have } \frac{d}{dx} \tan^{-1} \frac{x}{p + \iota q} &= \frac{p(p^2 + q^2 + x^2) - \iota q(p^2 + q^2 - x^2)}{(p^2 - q^2 + x^2)^2 + 4p^2q^2} \\ &= \frac{(p + \iota q)[(p - \iota q)^2 + x^2]}{[(p - \iota q)^2 + x^2][(p + \iota q)^2 + x^2]} = \frac{p + \iota q}{(p + \iota q)^2 + x^2}. \end{aligned}$$

That is, the ordinary rule for differentiating

$$\tan^{-1} \frac{x}{a}, \quad \text{viz. } \frac{d}{dx} \tan^{-1} \frac{x}{a} = \frac{a}{a^2 + x^2},$$

holds whether a be real or complex.

It also follows that $\int \frac{dx}{a^2 + x^2} = \frac{1}{a} \tan^{-1} \frac{x}{a}$ holds whether a be real or complex.

(5) Similarly, we might go on to discuss the other standard cases. The student may verify these for himself.

1197. Essential Difference in the Two Definitions of Integration.

Now the *summation* definition of integration loses its meaning when the integrand becomes infinite or discontinuous between or at the limits of integration. Let $x=c$ be a value of x at which the integrand becomes infinite or discontinuous. Then, if the integrand be regarded as the differential coefficient of some function of x , say y , there is a discontinuity in the value of dy/dx for the value $x=c$. And to interpret the summation definition it has been seen in Chapter IX. how Cauchy has given a new summation definition of $\int_b^a () dx$, viz. the limit of the summation

$$\int_b^{c-\epsilon} () dx + \int_{c+\eta}^a () dx,$$

where ϵ and η are to be diminished indefinitely in a ratio of equality, obtaining what Cauchy calls the Principal Value of the Integral. In this way the *discontinuity itself is avoided*. It is approached indefinitely from opposite sides, but the discontinuous element is omitted.

Thus a geometrical meaning is given to the symbol $\int_b^a () dx$, which, from the summation definition, would be otherwise meaningless. But regarding the integrand as the differential coefficient of the function y , the *discontinuity itself is an essential characteristic of that function*. Hence the two definitions do not agree if such points as the one under consideration occur within the range of integration. But it has been seen earlier that in the absence of such cases occurring between the limits of integration, there is agreement between the two definitions.

In the general theory of Definite Integrals, *i.e.* of those integrals between certain specified limits whose values may be sometimes found, as has been seen in the last three chapters, without any knowledge of the function which forms the indefinite integral, the indefinite integral is an unknown function of x , generally not capable of expression in finite terms by means of any of the known ordinary Algebraic, Exponential or Logarithmic, Circular, Hyperbolic or Inverse Functions.

1198. If then $f(x, c)$ be the known or unknown function of x , whose differential coefficient with regard to x is $F(x, c)$, we have

$$\int_b^a F(x, c)dx = \left[f(x, c) \right]_b^a = f(a, c) - f(b, c) = \chi(a, b, c) \text{ say,}$$

and the two definitions, *viz.* that of inverse differentiation and that of summation, agree except in the case where $F(x, c)$ assumes an infinite value or becomes discontinuous between the limits $x=a$ and $x=b$, and this will hold when c is changed to any other value, say c' , so long as such change does not make $F(x, c')$ become infinite or discontinuous for any value of x lying between $x=a$ and $x=b$, or at either limit.

It will follow that *whichever definition may have been used* in obtaining a specific result such as

$$\int_b^a F(x, c)dx = \chi(a, b, c),$$

where c is real, that result will still hold *under certain conditions* when a complex $p+iq$ is substituted for c , that is,

$$\int_b^a F(x, p+iq)dx = \chi(a, b, p+iq),$$

that is, *provided that none of the stipulations with regard to F and χ have been violated by the transformation.*

This entails that $F(x, c)$ shall be *finite and continuous* for all values of x from $x=b$ to $x=a$ inclusive.

That $F(x, p+iq)$ shall be *separable into real and imaginary parts* as

$$F_1(x, p, q) + iF_2(x, p, q).$$

That when this separation has been effected both $F_1(x, p, q)$ and $F_2(x, p, q)$ shall be *finite and continuous* functions of x for all values of x from $x=b$ to $x=a$ inclusive.

That $\chi(a, b, p+iq)$ is likewise *separable into real and imaginary parts* $\chi_1(a, b, p, q)$ and $\chi_2(a, b, p, q)$.

That when any convergent infinite series has been used, or its use in any way implied in the establishment of the primary result

$$\int_b^a F(x, c)dx = \chi(a, b, c),$$

or in the separation of $F(x, p+iq)$, $\chi(a, b, p+iq)$ into their respective real and imaginary parts, the convergency shall remain unaffected by the substitution of $p+iq$ for the real constant c for all values of x from $x=b$ to $x=a$ inclusive; and further, that when this convergency holds only

within definite limits of the values of p and q , the truth of the permanence of form of the result can only be inferred between such limits.

That the path of the original integration for values of x from a point $x=b$ to a point $x=a$ along the x -axis shall not have been altered in any way by the proposed change from a real constant c to a complex constant $p+iq$.

With such stipulations, we therefore have

$$\int_b^a \{F_1(x, p, q) + iF_2(x, p, q)\} dx = \chi_1(a, b, p, q) + i\chi_2(a, b, p, q),$$

whence $\int_b^a F_1(x, p, q) dx = \chi_1(a, b, p, q)$; $\int_b^a F_2(x, p, q) dx = \chi_2(a, b, p, q)$.

1199. If $F(x, c)$ and $\chi(a, b, c)$ be such that $\int_b^a F(x, c) dx = \chi(a, b, c)$ for all real values of c , and that $F(x, c)$ is developable as a series of positive integral powers of c uniformly and unconditionally convergent between specific values of c , for all values of x from b to a , so that $\int_b^a F(x, c) dx$ is capable of term by term integration, and is also developable in a like convergent series, and if $\chi(a, b, c)$ be also developable in a series of positive integral powers of c convergent for a specific range of values of c , the coefficients of like powers of c in $\int_b^a F(x, c) dx$ and $\chi(a, b, c)$ are equal for all values of c for which each series is convergent. And provided that this convergency remains in both series when we substitute a complex value $p+iq$ for c , the equality of $\int_b^a F(x, p+iq) dx$ and $\chi(a, b, p+iq)$ will still hold good for such values of p and q as do not disturb that convergency and do not cause F to assume an infinite or discontinuous value for any value of x between b and a .

If it be proposed to conduct the transition from c to $p+iq$ by a preliminary change to $p+q$, we have $\int_b^a F(x, p+q) dx = \chi(a, b, p+q)$; and if expansions of $F(x, p+q)$ and $\chi(a, b, p+q)$ be possible in series of integral powers of q , each uniformly convergent between specific limits of q , the coefficients of like powers of q in the expansions of $\int_b^a F(x, p+q) dx$ and $\chi(a, b, p+q)$ will be equal, and therefore, provided the convergency of these series be maintained when a change from q to $i q$ is made in them, and provided also that such changes have not caused F to assume an infinite or discontinuous value for any value of x between $x=b$ and $x=a$, we may infer that the transition to the complex $p+iq$ is legitimate.

1200. In the use of the method the precautions necessary before the results obtained can be accepted as rigorously established, are somewhat irksome, and this has caused mathematicians to look askance at the process. In fact it has become usual to regard it as a method of

suggestion of new integrals to be verified by other methods rather than as a mode of investigation. For instance, De Morgan remarks: "It is a matter of some difficulty to say how far this practice may be carried, it being most certain that there is an extensive class of cases in which it is allowable, and as extensive a class in which either the transformation, or neglect of some essential modification incident to the manner of doing it, leads to positive error. It is also certain that the line which separates the first and second class has not been distinctly drawn."

De Morgan, after citing several instances of the success of the method, gives as one of failure, the case of $\int_0^{\infty} \frac{dx}{1+x^2} = [\tan^{-1}x] = \frac{\pi}{2}$.

By putting $y\sqrt{-1}$ in place of x , he obtains $\int_0^{\infty} \frac{dx}{1+x^2} = \sqrt{-1} \int_0^{\infty} \frac{dy}{1-y^2}$, and remarks concerning this that it is "an equation which we cannot either affirm or deny, since the subject of integration in the second side becomes infinite between the limits."

We may, however, note with regard to this, that it apparently escaped De Morgan that having put $x = \sqrt{-1}y$, the range of values of y over which the integration is assumed to be conducted is not a *range of real values*, as was the case in the integration for the range of real values of x from 0 to ∞ . In fact y ranges from $\frac{0}{\sqrt{-1}}$ to $\frac{\infty}{\sqrt{-1}}$, corresponding to the real range of x from 0 to ∞ , and all the values through which y passes in this range are imaginaries, so that y never passes through the value 1 at all, and therefore the subject of integration never becomes infinite as De Morgan asserts. As a matter of fact, if we write $\frac{k}{\sqrt{-1}}$, for the upper limit,

$$\begin{aligned} \int_0^{\frac{k}{\sqrt{-1}}} \frac{dy}{1-y^2} &= \frac{1}{2} \int_0^{\frac{k}{\sqrt{-1}}} \left(\frac{1}{1-y} + \frac{1}{1+y} \right) dy = \frac{1}{2} \left[\log \frac{1+y}{1-y} \right]_0^{\frac{k}{\sqrt{-1}}} \\ &= \frac{1}{2} \log \frac{1 + \frac{k}{\sqrt{-1}}}{1 - \frac{k}{\sqrt{-1}}} = \frac{1}{2} \log \left(\frac{1 + \frac{1}{\sqrt{-1}}}{\frac{k}{\sqrt{-1}} - \frac{1}{\sqrt{-1}}} \right), \text{ and when } k \text{ is } \infty \\ &= \frac{1}{2} \log (-1) = \frac{1}{2} \log [\cos (2n-1)\pi + i \sin (2n-1)\pi] \\ &= \frac{1}{2} \log e^{i(2n-1)\pi} = \frac{(2n-1)\pi i}{2}, \end{aligned}$$

where n is an integer.

Hence $\sqrt{-1} \int_0^{\frac{k}{\sqrt{-1}}} \frac{dy}{1-y^2}$ has one of the values of $-(2n-1)\frac{\pi}{2}$, where n is an integer. The value $n=0$ gives the particular value $\frac{\pi}{2}$, which we have assigned to the left side, viz. $\int_0^{\infty} \frac{dx}{1+x^2}$.

But if in the formula $\int \frac{dx}{1+c^2x^2} = \frac{1}{c} \tan^{-1} cx$, c be replaced by ιc , we have $\int \frac{dx}{1-c^2x^2} = \frac{1}{c} \tanh^{-1} cx$. Both the right-hand side and the integrand become ∞ at $x=c^{-1}$ during the march of x from 0 to ∞ . Therefore, with those limits, the change proposed is inadmissible. We defer the consideration of the use of a complex variable to the next chapter. And it is to be understood in all the remarks made in course of this discussion, that the march of the variable between its limits is not to be interfered with by the substitution of a complex constant for a real one, *i.e.* that the change of c to $p+iq$ is not supposed to be one which can be brought about by a change in the *variable*, as is done in the case cited.

ILLUSTRATIONS.

1201. (1) Taking $\int x^{n-1} dx = \frac{x^n}{n}$, write $n = a + \iota b$.

Then $\int x^{a-1} x^{\iota b} dx = x^{a+\iota b} / (a + \iota b)$ [Art. 1196 (1)],

i.e. $\int x^{a-1} \{ \cos (b \log x) + \iota \sin (b \log x) \} dx$
 $= [x^a \cos (b \log x) + \iota x^a \sin (b \log x)] (a - \iota b) / (a^2 + b^2)$;

whence, writing $x = e^\theta$,

$$\int e^{a\theta} \cos b\theta d\theta = e^{a\theta} \frac{a \cos b\theta + b \sin b\theta}{a^2 + b^2}, \quad \int e^{a\theta} \sin b\theta d\theta = e^{a\theta} \frac{a \sin b\theta - b \cos b\theta}{a^2 + b^2},$$

which are the well-known results proved elsewhere without the use of complex values.

(2) In the integral $I \equiv \int_a^b \frac{dx}{x+c} = \left[\log (x+c) \right]_a^b = \log \frac{b+c}{a+c}$, put $c = qe^{\iota a}$.

$$\text{Then } \frac{1}{x+c} = \frac{1}{x+qe^{\iota a}} = \frac{x+qe^{-\iota a}}{x^2+2qx \cos a+q^2} = \frac{x+q \cos a - \iota q \sin a}{x^2+2qx \cos a+q^2},$$

and

$$\log \frac{b+qe^{\iota a}}{a+qe^{\iota a}} = \frac{1}{2} \log \frac{b^2+2bq \cos a+q^2}{a^2+2aq \cos a+q^2} + \iota \left(\tan^{-1} \frac{q \sin a}{b+q \cos a} - \tan^{-1} \frac{q \sin a}{a+q \cos a} \right).$$

Therefore

$$\left. \begin{aligned} \int_a^b \frac{x+q \cos a}{x^2+2qx \cos a+q^2} dx &= \frac{1}{2} \log \frac{b^2+2bq \cos a+q^2}{a^2+2aq \cos a+q^2} \\ \text{and } \int_a^b \frac{q \sin a dx}{x^2+2qx \cos a+q^2} &= \tan^{-1} \frac{b+q \cos a}{q \sin a} - \tan^{-1} \frac{a+q \cos a}{q \sin a} \end{aligned} \right\}$$

results which are obviously true otherwise.

The process is valid, for all the conditions laid down in Art. 1198 are fulfilled.

(3) In $I \equiv \int_0^{\infty} e^{-ax} \cos bx dx = \frac{a}{a^2+b^2}$, write $a = ce^{\iota \alpha}$,
 (a, c both $+$; α , acute),

$$\int_0^{\infty} e^{-cx \cos \alpha} e^{-\iota cx \sin \alpha} \cos bx dx = \frac{c(b^2 e^{\iota \alpha} + c^2 e^{-\iota \alpha})}{b^4 + 2b^2 c^2 \cos 2\alpha + c^4}$$

Equating real and unreal parts,

$$I_1 = \int_0^{\infty} e^{-cx \cos a} \cos bx \cos (cx \sin a) dx = \frac{c(b^2 + c^2) \cos a}{b^4 + 2b^2c^2 \cos 2a + c^4},$$

$$I_2 = \int_0^{\infty} e^{-cx \cos a} \cos bx \sin (cx \sin a) dx = \frac{c(c^2 - b^2) \sin a}{b^4 + 2b^2c^2 \cos 2a + c^4}.$$

The change from a to ce^{ia} does not affect the path of integration with regard to x from 0 to ∞ ; the integrands remain finite and continuous throughout the range, and though the upper limit is infinite both integrands are zero when x is infinite, and the conditions of the validity of the process are all satisfied. Hence it will be fair to assume the results correct. They may be readily verified otherwise.

(4) In $I \equiv \int_0^{\infty} e^{-a^2x^2} dx = \frac{\sqrt{\pi}}{2a}$, write $a = ce^{ia}$, (a and $c + i$; a , acute).

Then $\int_0^{\infty} e^{-c^2x^2 (\cos 2a + i \sin 2a)} dx = \frac{\sqrt{\pi}}{2c} e^{-ia}$.

Therefore $\left. \begin{aligned} \int_0^{\infty} e^{-c^2x^2 \cos 2a} \cos (c^2x^2 \sin 2a) dx &= \frac{\sqrt{\pi}}{2c} \cos a, \\ \int_0^{\infty} e^{-c^2x^2 \cos 2a} \sin (c^2x^2 \sin 2a) dx &= \frac{\sqrt{\pi}}{2c} \sin a. \end{aligned} \right\}$

The new integrands satisfy the conditions under which the transition is permissible.

Putting $a = \frac{\pi}{4}$, we have Fresnel's integrals of Art. 1163, viz.

$$\int_0^{\infty} \cos c^2x^2 dx = \frac{\sqrt{\pi}}{2c\sqrt{2}},$$

$$\int_0^{\infty} \sin c^2x^2 dx = \frac{\sqrt{\pi}}{2c\sqrt{2}}.$$

(5) In $I \equiv \int_{-\infty}^{\infty} e^{-a^2x^2} dx = \frac{\sqrt{\pi}}{a}$, write $a = m(1 + a)$, (a , $+i$).

Then $\int_{-\infty}^{\infty} e^{-m^2(1+a)^2x^2} dx = \frac{\sqrt{\pi}}{m(1+a)}$.

Both sides are capable of expansion in powers of a , convergent for values of a which lie between -1 and $+1$. And both series remain convergent when we replace a by an unreal quantity with modulus < 1 . Hence, writing $\beta\sqrt{-1}$ for a , where $\beta < 1$, we obtain

$$\int_{-\infty}^{\infty} e^{-m^2(1-\beta^2)x^2} (\cos 2m^2\beta x^2 - i \sin 2m^2\beta x^2) dx = \frac{\sqrt{\pi}}{m} \frac{1}{1+i\beta} = \frac{\sqrt{\pi}}{m} \frac{1-i\beta}{1+\beta^2}$$

$(\beta < 1)$;

whence

$$\left. \begin{aligned} \int_{-\infty}^{\infty} e^{-m^2(1-\beta^2)x^2} \cos 2m^2\beta x^2 dx &= \frac{\sqrt{\pi}}{m} \frac{1}{1+\beta^2}, \\ \int_{-\infty}^{\infty} e^{-m^2(1-\beta^2)x^2} \sin 2m^2\beta x^2 dx &= \frac{\sqrt{\pi}}{m} \frac{\beta}{1+\beta^2} \end{aligned} \right\} (\beta < 1).$$

(6) Taking the integral

$$I \equiv \int_{-\infty}^{\infty} e^{-p^2 x^2} \cosh 2qx \, dx = \frac{\sqrt{\pi}}{p} e^{\frac{q^2}{p^2}}$$

we observe that $\cosh 2qx$ and $e^{\frac{q^2}{p^2}}$ can both be developed in ascending powers of q which are both convergent series, and that if we write iq for q , the convergence will not be affected.

Hence, we may safely infer that

$$\int_{-\infty}^{\infty} e^{-p^2 x^2} \cos 2qx \, dx = \frac{\sqrt{\pi}}{p} e^{-\frac{q^2}{p^2}},$$

and as the integrands in these integrals are not affected by changing the sign of x in either case, either integral may be taken from 0 to ∞ , and the results are still true, provided in that case the right-hand sides be halved.

(7) In $I \equiv \int_0^{\infty} e^{-c^2(x^2 + \frac{a^2}{x^2})} dx = \frac{\sqrt{\pi}}{2c} e^{-2ca}$, write $c = ke^{i\alpha}$.

Then $\int_0^{\infty} e^{-k^2 e^{2i\alpha}(x^2 + \frac{a^2}{x^2})} dx = \frac{\sqrt{\pi}}{2k} e^{-i\alpha} e^{-2ak^2 e^{2i\alpha}}$;

$$\therefore \left. \begin{aligned} \int_0^{\infty} e^{-k^2(x^2 + \frac{a^2}{x^2}) \cos 2\alpha} \cos \left\{ k^2 \left(x^2 + \frac{a^2}{x^2} \right) \sin 2\alpha \right\} dx \\ = \frac{\sqrt{\pi}}{2k} e^{-2ak^2 \cos 2\alpha} \cos(\alpha + 2ak^2 \sin 2\alpha), \\ \int_0^{\infty} e^{-k^2(x^2 + \frac{a^2}{x^2}) \cos 2\alpha} \sin \left\{ k^2 \left(x^2 + \frac{a^2}{x^2} \right) \sin 2\alpha \right\} dx \\ = \frac{\sqrt{\pi}}{2k} e^{-2ak^2 \cos 2\alpha} \sin(\alpha + 2ak^2 \sin 2\alpha). \end{aligned} \right\}$$

[Cf. Cauchy, *Mém. des Sav. Étrangers*, i., p. 638.]

(8) Taking Laplace's integral $\int_0^{\infty} e^{-a^2 x^2} \cos 2bx \, dx = \frac{\sqrt{\pi}}{2a} e^{-\frac{b^2}{a^2}}$, write $a = ce^{\frac{i\pi}{4}}$; then $a^2 = c^2 e^{\frac{i\pi}{2}} = ic^2$ and $e^{-a^2 x^2} = e^{-ic^2 x^2} = \cos c^2 x^2 - i \sin c^2 x^2$.

Therefore $\int_0^{\infty} (\cos c^2 x^2 - i \sin c^2 x^2) \cos 2bx \, dx = \frac{\sqrt{\pi}}{2c} e^{-i \left(\frac{\pi}{4} - \frac{b^2}{c^2} \right)}$;

whence $\int_0^{\infty} \cos c^2 x^2 \cos 2bx \, dx = \frac{\sqrt{\pi}}{2c} \cos \left(\frac{\pi}{4} - \frac{b^2}{c^2} \right)$,

$$\int_0^{\infty} \sin c^2 x^2 \sin 2bx \, dx = \frac{\sqrt{\pi}}{2c} \sin \left(\frac{\pi}{4} - \frac{b^2}{c^2} \right),$$

results due to Fourier.*

* *Traité de la Chaleur*, p. 533; Gregory, *D.C.*, p. 485.

PROBLEMS.

1. Show that
$$\int_0^{\pi} \cos^n x \cos nx \, dx = \frac{\pi}{2^n}. \quad [\text{COLLEGES, 1892.}]$$

Show also that
$$\int_0^{\pi} \cos^n \theta \cos (n-2r)\theta \, d\theta = {}^nC_r \frac{\pi}{2^n}.$$

2. Evaluate $\int_0^k \left(1 - \frac{x}{k}\right)^k x^{n-1} \, dx$, where n is positive and k a positive integer. [ST. JOHN'S, 1892.]

3. Prove that
$$\frac{2}{\pi} \int_0^{\pi} e^{c \cos x} \sin (c \sin x) \sin nx \, dx = \frac{c^n}{n!}. \quad [\text{MATH. TRIPOS., 1872.}]$$

4. If m be a positive integer, prove that

$$\int_0^{\frac{\pi}{2}} (2 \cos x)^{m-1} x \sin (m+1)x \, dx = \frac{\pi}{4m}. \quad [\text{COLLEGES } \epsilon, 1883.]$$

5. If n be positive and less than unity, show that

$$\int_0^{\infty} \frac{\cos nx}{x^{n+1}} \, dx = \frac{\gamma^{n-1}}{\Gamma(n)} \frac{\pi}{2} \sec \frac{n\pi}{2}. \quad [\text{COLLEGES } \beta, 1889.]$$

6. Show that

$$\int_0^{\frac{\pi}{2}} \frac{\cos 2s\psi \cos p\psi}{\cos^p \psi} \, d\psi = \pi (-1)^s 2^{p-2} \frac{\Gamma(p+1) \dots (\Gamma+s-1)}{s^p},$$

where p is any negative quantity or any positive proper fraction.

[COLLEGES γ , 1888.]

7. Establish the result

$$\int_0^1 \cosh (p \log x) \log (1+x) \frac{dx}{x} = \frac{1}{2^p} \left(\frac{\pi}{\sin p\pi} - \frac{1}{p} \right) \quad (p < 1). \quad [\text{COLLEGES } \delta, 1883.]$$

8. Evaluate
$$\int_0^{2\pi} \frac{\sin^2 \theta \, d\theta}{1 - 2 \sin a \sin \theta + \sin^2 a}. \quad [\text{COLLEGES } \beta, 1890.]$$

9. Show that the product of the two integrals

$$\int_0^{\infty} e^{-x^2} x^{2n-1} \, dx \quad \text{and} \quad \int_0^{\infty} e^{-x^2} x^{1-2n} \, dx \quad \text{is} \quad \frac{\pi}{4 \sin n\pi}. \quad [\text{COLLEGES } \alpha, 1890.]$$

10. If $u = \int_0^k e^{x^2} \, dx$, show that $u^2 = \int_0^{\frac{\pi}{4}} (e^{k^2 \sec^2 \theta} - 1) \, d\theta. \quad [\text{COLLEGES } \alpha, 1890.]$

11. Show that
$$\int_0^{\infty} \frac{\log_e \sin \theta}{a^2 + \theta^2} \, d\theta = \frac{\pi}{2a} \log \left\{ \frac{1}{2} (1 - e^{-2a}) \right\}. \quad [\text{COLLEGES, 1892, etc.}]$$

12. Show that

$$\int_0^{\pi} \tan^{-1} \frac{a \sin x}{1 + a \cos x} dx = 2 \left(a + \frac{a^3}{3^2} + \frac{a^5}{5^2} + \dots \right) \text{ if } a < 1. \quad [\text{MATH. TRIPOS, 1882.}]$$

13. Prove that

$$\int_0^{2\pi} \cos n\theta \log(1 + 2m \cos \theta + m^2) d\theta = -\frac{2\pi}{n} m^n \text{ or } \frac{2\pi}{n} m^n,$$

according as n is even or odd ($1 > m > 0$). [R. P.]

14. Find the value of $\int_0^{\pi} \sin n\theta \tan^{-1} \frac{a \sin \theta}{1 - a \cos \theta} d\theta,$

where $-1 < a < 1$ and n is an integer. [OXFORD II. P., 1900.]

15. If m, n being each less than unity, and $\sin x = n \sin(x + y)$, show that

$$\int_0^{\pi} \frac{x \sin y dy}{1 - 2m \cos y + m^2} = \frac{\pi}{2m} \log \frac{1}{1 - mn}. \quad [\text{ST. JOHN'S, 1891.}]$$

16. Show that

$$\int_0^{\infty} \frac{x^{2m}}{(x^{2n} + a^{2n})^{k+1}} dx = Q a^{-2(k+1)n+2m+1} \frac{\pi}{2n} \operatorname{cosec} \frac{2m+1}{2n} \pi,$$

where m, n and k are all positive integers and $m < n$, and Q is the coefficient of c^k in the expansion of $(1 - c)^{\frac{2m+1-2n}{2n}}$ in ascending powers of c . [COLLEGES α , 1887.]

17. Prove that

$$\int_0^{\infty} \frac{dx}{(1+x^2)(1-2a \cos x + a^2)} = \frac{\pi}{2(1-a^2)} \frac{e+a}{e-a} \quad (0 < a < 1). \quad [\text{COLLEGES } \gamma, 1888.]$$

18. Prove that $\int_0^{\pi} \frac{\cos n\theta}{a - \cos \theta} d\theta = \frac{(a - \sqrt{a^2 - 1})^n}{(a^2 - 1)^{\frac{1}{2}}} \pi,$ where $a > 1$.

[ST. JOHN'S, 1881.]

19. Prove that

$$\int_0^{\pi} \left\{ \frac{e + \cos \theta}{1 + 2e \cos \theta + e^2} \right\}^2 d\theta = \frac{\pi}{2(1-e^2)} \text{ or } \frac{\pi}{2} \frac{2e^2 - 1}{e^2(e^2 - 1)},$$

according as $e < 1$ or $e > 1$. [R. P.]

20. Show that $\int_0^{\infty} \frac{x^n dx}{1 + 2x \cos \alpha + x^2} = \frac{\pi}{\sin n\pi} \frac{\sin n\alpha}{\sin \alpha},$ where n is not an integer and $\pi > \alpha > 0$. [ST. JOHN'S, 1891.]

21. Show that $\int_0^{\infty} \frac{dx}{1+x^n} = \frac{\pi}{n} \operatorname{cosec} \frac{\pi}{n}$, if $n > 1$, and thence show that if n be positive,

$$\int_0^{\infty} \log x \log \left(1 + \frac{a^n}{x^n}\right) dx = \pi a \operatorname{cosec} \frac{\pi}{n} \left(\log a - \frac{\pi}{n} \cot \frac{\pi}{n} - 1\right).$$

[MATH. TRIPOS, 1883.]

22. Expand the definite integral

$$\int_0^1 dx \frac{x^{\alpha-1}(1-x)^{\beta-1}}{(1-ux)^{\gamma}},$$

in the form of a series of ascending powers of u ; and thence or otherwise find the relations which must subsist between α , β , γ and the indices α' , β' , γ' of a like integral, in order that the two integrals may be to each other in a ratio independent of u .

[SMITH'S PRIZE, 1875.]

23. Prove that

$$\int_0^{\pi} \frac{\sin^2 x dx}{(1-2a \cos x + a^2)(1-2b \cos x + b^2)} = \frac{\pi}{2(1-ab)} \begin{cases} a < 1 \\ b < 1 \end{cases}.$$

[COLLEGES γ , 1893.]

24. Point out the fallacy in the following train of reasoning. By putting $ax = y$, we have

$$\int_0^{\infty} \frac{e^{-ax}}{x} dx = \int_0^{\infty} \frac{e^{-y}}{y} dy; \quad \therefore \int_0^{\infty} \frac{e^{-ax} - e^{-bx}}{x} dx = \int_0^{\infty} \frac{e^{-y}}{y} dy - \int_0^{\infty} \frac{e^{-y}}{y} dy = 0.$$

Show that the value of the latter integral is $\log \frac{b}{a}$.

[TRINITY COLLEGE, 1882.]

25. Deduce from the expansion of $\log(1+x)$ that if $x \neq 1$

$$\frac{x^2}{1^2} + \frac{x^4}{2^2} + \frac{x^6}{3^2} + \frac{x^8}{4^2} + \dots = \frac{1}{2\pi} \int_0^{\pi} [\log(1+2x \cos \theta + x^2)]^2 d\theta.$$

Deduce Euler's series

$$\frac{1}{1^2} + \frac{1}{2^2} + \frac{1}{3^2} + \frac{1}{4^2} + \dots = \frac{\pi^2}{6}.$$

26. Show that if $I_r = \int_0^{\pi} \sin r\theta \cot \frac{\theta}{2} d\theta$, then $I_r = I_{r-1}$.

Hence show that $I_r = \pi$.

27. By differentiating $u = \int_0^h \frac{\phi(ax)}{x^2} dx$ with regard to a , show that

$$\frac{du}{da} = \int_0^h \frac{\phi'(x)}{x} dx - \phi'(0) \log a - \frac{\phi(h)}{h}.$$

Hence deduce

$$\int_0^{\infty} \frac{\phi(ax) - \phi(bx)}{x^2} dx = (a-b) \int_0^{\infty} \frac{\phi'(x)}{x} dx - \phi'(0)[a \log a - b \log b - a + b] - (a-b) Lt_{h \rightarrow \infty} \frac{\phi(h)}{h},$$

on the supposition that ϕ is such that $Lt_{h \rightarrow \infty} \int_b^h \frac{\phi(x)}{x^2} dx$ vanishes.

$$\text{Apply this to show that } \int_0^{\infty} \frac{\cos ax - \cos bx}{x^2} dx = \frac{\pi}{2}(b-a).$$

[BERTRAND, *Calc. Int.*, p. 225.]

28. Prove that if m, n are positive integers whose H.C.F. is r , and $m = r\mu, n = r\nu$, and p, q numerically less than unity, then will

$$\int_0^{\pi} \frac{dx}{(1 - 2p \cos mx + p^2)(1 - 2q \cos nx + q^2)} = \frac{\pi}{(1-p^2)(1-q^2)} \frac{1+p^\nu q^\mu}{1-p^\nu q^\mu}.$$

$$29. \text{ Show that } \int_0^{\pi} \frac{\cos rx}{1 + e \cos x} dx = \frac{\pi}{\sqrt{1-e^2}} \left[\frac{\sqrt{1-e^2}-1}{e} \right]^r.$$

[COLLEGES δ , 1884.]

$$30. \text{ Evaluate } \int_0^{\frac{\pi}{2}} \sin^2 x \log \tan x dx.$$

31. Prove that if n be a positive integer,

$$(i) \int_0^{\frac{\pi}{2}} \cos 2n\theta \log(\sin \theta) d\theta = -\frac{\pi}{4n}, \quad (ii) \int_0^{\frac{\pi}{2}} \cos nx (\cos x)^n dx = \frac{\pi}{2^{n+1}}.$$

32. Prove that, n being a positive integer,

$$(i) \int_0^{\frac{\pi}{2}} \cos 2n\theta \log \sin \theta d\theta = -\frac{\pi}{4n};$$

$$(ii) \int_0^{\frac{\pi}{2}} \cos 2n\theta \{\log(2 \sin \theta)\}^2 d\theta = \pi A_n / 2n;$$

$$(iii) \int_0^{\frac{\pi}{2}} \{\log(2 \sin \theta)\}^4 d\theta = \pi^5 / 288 + \sum_1^{\infty} \pi A_n^2 / n^2,$$

$$\text{where } A_n = 1 + \frac{1}{2} + \frac{1}{3} + \frac{1}{4} + \dots + \frac{1}{n-1} + \frac{1}{2n}.$$

[ST. JOHN'S, 1891.]

$$33. \text{ Evaluate } \int_0^{\pi} \frac{x \sin x}{(1 - a \cos x)^2} dx \quad (a < 1).$$

[COLLEGES, 1890.]

34. Prove that if n be a positive integer and $\pi/2 > a > 0$, then

$$\int_0^{\infty} \frac{dx}{x} \frac{\sin^{2n-1} x}{(1 - \sin^2 a \sin^2 x)^n} = \frac{\pi}{2^n} \frac{1 \cdot 3 \cdot 5 \dots (2n-3)}{(n-1)!} \sec^{2n-1} a.$$

[ST. JOHN'S, 1887.]

35. Show that $2 \int_0^{\frac{\pi}{2}} \sec x \log(1 + \sin a \cos x) dx = \pi a - a^2$.

Hence deduce $\int_0^1 \frac{\log \{2/(1+x^2)\}}{1-x^2} dx$. [TRINITY, 1884.]

36. Prove that if $x < 1$,

$$\int_0^{\pi} \log \frac{1+x \cos \theta}{1-x \cos \theta} \frac{d\theta}{\cos \theta} = 2\pi \sin^{-1} x. \quad [\text{COLLEGES } \alpha, 1891.]$$

37. If $u + v = 4$, $u - v = 2 \sin \theta$, show that

$$\int_0^{\infty} \log \frac{u^v}{v^u} \cdot \frac{d\theta}{\theta} = \frac{\pi^2}{3} - \pi \log \left(2 \cos^2 \frac{\pi}{12} \right).$$

38. If m and n are positive integers, prove that

$$\int_0^{\infty} \frac{\cos(2m+1)x - \cos(2n+1)x}{x \sin x} dx = (n-m)\pi. \quad [\text{OXFORD II., 1890.}]$$

39. Prove that

$$\int_0^{\frac{\pi}{2}} \{ \tan^{-1}(a \tan x) - \tan^{-1}(b \tan x) \} (\tan x + \cot x) dx = \frac{\pi}{2} \log \frac{a}{b},$$

where a and b are both positive. [OXFORD II., 1886.]

40. Show that $\int_0^{\infty} \frac{e^{-bx} \sin \beta x - e^{-ax} \sin \alpha x}{x} dx = 0$ if $\frac{a}{\alpha} - \frac{b}{\beta} = 0$, and a and b be positive. [CLARE, CAIUS AND KING'S, 1885.]

41. Prove that $\iiint e^{-\frac{lx+my+nz}{a}} dx dy dz$ extended over the volume of the ellipsoid $x^2/a^2 + y^2/b^2 + z^2/c^2 = 1$ is equal to $4\pi abc/e$, a being equal to $\sqrt{a^2l^2 + b^2m^2 + c^2n^2}$ and l, m, n being direction cosines. [COLLEGES, 1886.]

42. Show that

$$\int_0^{\infty} \left\{ \frac{e^{-ax} - e^{-bx}}{x^2} + (a-b) \frac{e^{-bx}}{x} \right\} dx = b - a - a \log \frac{b}{a},$$

where a and b are positive quantities. [TRINITY, 1892.]

43. Prove that $\int_0^{\frac{\pi}{2}} \frac{\{ \theta - \tan^{-1}(n \tan \theta) \} \sin 2\theta d\theta}{1 + 2n \cos 2\theta + n^2} = \frac{\pi}{4n} \log \frac{1+n}{1+n^2}$ if n be less than unity.

Determine also the value of the same integral when n is greater than unity. [ST. JOHN'S, 1891.]

44. Prove that, for any value of n , provided α be between 0 and π ,

$$\int_0^{\infty} \frac{dx}{(1+x^n)(1+2x \cos \alpha + x^2)} = \frac{\alpha}{2 \sin \alpha}$$

and

$$\int_0^{\infty} \frac{(1+x^2)dx}{(1+x^n)(1-2x^2 \cos 2\alpha + x^4)} = \frac{\pi}{4 \sin \alpha}.$$

[ST. JOHN'S COLL., 1881.]

45. Prove that if c be positive and less than unity,

$$\int_0^{\pi} \sin 2n\phi \int_0^{\infty} e^{-xc^2 \sin^2 \phi} \cos \{cx \sin^2 \phi (1 - c \cos \phi)\} dx d\phi = 2\pi c \frac{1 - c^{2n}}{(1 - c^2)^2}.$$

[MATH. TRIPOS, 1886.]

46. Prove that

$$\int_0^c \int_0^{\sqrt{\frac{c^2-z^2}{1+m^2}}} \int_{my}^{\sqrt{c^2-y^2-z^2}} \frac{x(x^2+y^2+z^2)}{(x^2+y^2+z^2+4c^2)^4} dx dy dz = \frac{\pi}{12000c^2 \sqrt{1+m^2}}.$$

[ST. JOHN'S, 1885.]

47. Show that

$$\begin{aligned} \int_0^{\pi} \int_0^{2\pi} f(m \cos \theta + n \sin \theta \sin \phi + p \sin \theta \cos \phi) \sin \theta d\theta d\phi \\ = 2\pi \int_{-1}^{+1} f\{x\sqrt{m^2+n^2+p^2}\} dx. \end{aligned}$$

[POISSON.]

48. Prove that if n be a positive integer,

$$\int_0^{\frac{\pi}{2}} \int_0^{\frac{\pi}{2}} \frac{\sin^{2n+2} x \{ \sin^{2n+2} y - \sin^{2n+2} x \}}{\sin^2 y - \sin^2 x} dy dx = \frac{\pi^2}{8}.$$

[ST. JOHN'S, 1888.]

49. Prove that

$$\int_0^{\frac{\pi}{2}} \int_0^{\frac{\pi}{2}} (1 - \sin^2 \omega \sin^2 \theta)^{\frac{m}{2}} \sin^{n+1} \omega d\theta d\omega$$

is a symmetric function of m and n .

[MATH. TRIP., 1895.]

50. Prove that

$$\int_{-\infty}^{\infty} \int_{-\infty}^{\infty} e^{-(x^2+2xy \cos 2a+y^2)} dx dy = \sqrt{\pi} \int_0^{\frac{\pi}{2}} \frac{d\theta}{\sqrt{1 - \sin^2 a \sin^2 \theta}}.$$

[OX. II. PUB., 1902.]

51. Prove that

$$\int_{-\infty}^{\infty} e^{ax} \frac{d^n}{dx^n} \left(e^{-\frac{x^2}{2}} \right) dx = (-1)^n \sqrt{2\pi} a^n e^{\frac{a^2}{2}}.$$

52. If $u = (ab' - a'b)x^2 + (ac' - a'c)xy + (bc' - b'c)y^2$, prove that

$$\int_{-\infty}^{\infty} \int_{-\infty}^{\infty} e^{-u^2} u dx dy = \frac{\pi}{\sqrt{E}},$$

where $E = 4(ab' - a'b)(bc' - b'c) - (ca' - c'a)^2$, provided

$$4(b^2 - ac)(b'^2 - a'c') > (2bb' - ac - a'c')^2. \quad [\text{ST. JOHN'S, 1886.}]$$

53. Show that

$$\int_0^{\infty} \int_0^{\infty} e^{-ax^2 - 2cxy - by^2} dx dy = \frac{1}{2\sqrt{ab - c^2}} \cos^{-1} \frac{c}{\sqrt{ab}}$$

if $a > 0$ and $ab - c^2 > 0$.

[I. C. S., 1897.]

54. Show that

$$\int_0^{\infty} \int_0^{\infty} y \cosh 2cxy e^{-ax^2 - by^2} dx dy = \frac{\sqrt{\pi a}}{4(ab - c^2)}$$

if a, b, c are positive quantities and $ab - c^2 > 0$.

[I. C. S., 1897.]

55. Show that

$$\int_0^{\frac{\pi}{2}} \int_0^{\frac{\pi}{2}} F(1 - \sin \theta \cos \phi) \sin \theta d\theta d\phi = \frac{1}{2} \pi \int_0^1 F(u) du.$$

[ST. JOHN'S, 1891.]

56. Prove that

$$\int_0^{\infty} \int_0^{\infty} \phi(a^2x^2 + b^2y^2) dx dy = \frac{\pi}{4ab} \int_0^{\infty} \phi(x) dx.$$

57. Calculate the value of $\iint \frac{dx dy}{r_1 r_2}$ taken throughout the ellipse

$$\frac{x^2}{a^2} + \frac{y^2}{b^2} = 1,$$

where r_1 and r_2 are the distances of the point x, y from the foci.

[COLLEGES a, 1889.]

58. If $V \equiv \sin p_1 \theta \sin p_2 \theta \sin p_3 \theta \dots \sin p_{2n+1} \theta$, where $p_1, p_2, \dots, p_{2n+1}$ are any positive integers whose sum is odd, prove that

$$\int_0^{\pi} \frac{V d\theta}{\theta} = \int_0^{\frac{\pi}{2}} \frac{V d\theta}{\sin \theta}.$$

[ST. JOHN'S, 1892.]

59. Show, by means of Landen's Transformation

$$\tan(\theta - \phi) = \frac{a - b}{a + b} \tan \theta,$$

that
$$\int_0^{i\pi} \frac{d\theta}{(a^2 \cos^2 \theta + b^2 \sin^2 \theta)^{\frac{1}{2}}} = \int_0^{i\pi} \frac{d\phi}{(a_1^2 \cos^2 \phi + b_1^2 \sin^2 \phi)^{\frac{1}{2}}},$$

where a_1 and b_1 are respectively the arithmetic and the geometric means between a and b .

Point out the value of this result in the calculation of the numerical value of the definite integral.

[MATH. TRIPOS, 1889.]

60. If p be the length of the perpendicular from the centre of the ellipsoid $\frac{x^2}{a^2} + \frac{y^2}{b^2} + \frac{z^2}{c^2} = 1$, on an element dS of the surface, prove that

$$\iint \frac{dS}{p} = 2\pi a^2 b^2 c^2 \left\{ \frac{d}{d(a^2)} + \frac{d}{d(b^2)} + \frac{d}{d(c^2)} \right\}^2 \int_0^\infty \frac{dx}{\sqrt{(a^2 + \lambda)(b^2 + \lambda)(c^2 + \lambda)}}.$$

[COLLEGES γ , 1901.]

61. Show that
$$\int_0^\infty \frac{\sin r\theta \sin n\theta}{\theta \sin \theta} d\theta = n \frac{\pi}{2},$$

provided n is an integer and r any quantity $> n - 1$.

[MATH. TRIP., 1873.]

62. Prove that
$$\int_0^4 \frac{\log x}{\sqrt{4x - x^2}} dx = 0.$$

[CLARE, CAIUS, KING'S, 1886.]

63. Prove that
$$2 \int_{-\frac{\pi}{4}}^{\frac{\pi}{4}} \log(1 + \sin 2\theta) d\theta + \pi \log 2 = 0.$$

Hence, or otherwise, find the value of

$$\frac{1}{2^2} + \frac{1 \cdot 3}{2 \cdot 4^2} + \frac{1 \cdot 3 \cdot 5}{2 \cdot 4 \cdot 6^2} + \dots \quad [\text{OX. I. P., 1900.}]$$

64. If u, u' are essentially positive quadratic functions of x ; Δ, Δ' their discriminants and H the invariant intermediate to Δ and Δ' , prove that

$$\int_{-\infty}^{\infty} \log \frac{u'}{u} \cdot \frac{dx}{u} = \frac{\pi}{\sqrt{\Delta}} \log \frac{H + 2\sqrt{\Delta\Delta'}}{4\Delta}.$$

[NANSON, E. T., 13406.]

65. If
$$\sum_{n=0}^{\infty} a_n x^n = \phi(x) \quad \text{and} \quad \sum_{n=0}^{\infty} b_n x^n = \psi(x),$$

show that

$$\sum_{n=0}^{\infty} a_n b_n x^n = \frac{1}{2\pi} \int_0^\pi \{ \phi(xe^{i\theta}) + \phi(xe^{-i\theta}) \} \{ \psi(e^{i\theta}) + \psi(e^{-i\theta}) \} d\theta - a_0 b_0.$$

If also $\sum_{n=0}^{\infty} c_n x^n = \chi(x)$, show how to express $\sum_{n=0}^{\infty} a_n b_n c_n x^n$ by means of a double integral. [SMAASEN.]

66. Prove that

$$\begin{aligned} & 1 + \frac{\mu x}{1! 2!} + \frac{\mu^2 x^2}{2! 4!} + \frac{\mu^3 x^3}{3! 6!} + \dots \\ &= \frac{2}{\pi} \int_0^\pi e^{\mu \cos \theta} \cosh\left(\sqrt{x} \cos \frac{\theta}{2}\right) \cos(\mu \sin \theta) \cos\left(\sqrt{x} \sin \frac{\theta}{2}\right) d\theta - 1. \end{aligned}$$

[W. H. L. RUSSELL.]

67. Show that

$$\int_{-\frac{\pi}{2}}^{\frac{\pi}{2}} e^{ax} \cos^{2n} x \, dx = \frac{(2n)!}{(a^2 + 2^2)(a^2 + 4^2) \dots \{a^2 + (2n)^2\}} \cdot \frac{2 \sinh \frac{a\pi}{2}}{a}.$$

Hence prove that

$$1 + \frac{x}{a^2 + 2^2} + \frac{x^2}{(a^2 + 2^2)(a^2 + 4^2)} + \frac{x^3}{(a^2 + 2^2)(a^2 + 4^2)(a^2 + 6^2)} + \dots \\ = \frac{a}{2} \operatorname{cosech} \frac{a\pi}{2} \int_{-\frac{\pi}{2}}^{\frac{\pi}{2}} e^{a\theta} \cosh(\sqrt{x} \cos \theta) \, d\theta.$$

[W. H. L. RUSSELL.]

68. Show that $\int_{-\infty}^{\infty} e^{-\frac{ax^2}{4}} (e^x - \cos x) \, dx = 4 \sqrt{\frac{\pi}{a}} \sinh \frac{1}{a}.$

[W. H. L. RUSSELL.]

69. Establish the results

$$(i) \int_0^{\infty} f\left(x + \frac{1}{x}\right) \log x \frac{dx}{x} = 0. \\ (ii) \int_0^{\infty} f\left(x + \frac{1}{x}\right) \tan^{-1} x \frac{dx}{x} = \frac{\pi}{4} \int_0^{\infty} f\left(x + \frac{1}{x}\right) \frac{dx}{x}.$$

[LIOUVILLE]

70. Establish the results

$$(i) \int_0^{\infty} f\left(x + \frac{1}{x}\right) \frac{1}{1+x^n} \frac{dx}{x} = \frac{1}{2} \int_0^{\infty} f\left(x + \frac{1}{x}\right) \frac{dx}{x}. \\ (ii) \int_0^{\infty} \frac{dx}{(1+x^2)(1+x^n)} = \frac{\pi}{4}. \\ (iii) \int_0^{\frac{\pi}{2}} \frac{F(\sin 2\theta)}{1 + \tan^n \theta} \, d\theta = \frac{1}{2} \int_0^{\frac{\pi}{2}} F(\sin \theta) \, d\theta.$$

[GLAISHER, *Messenger of Math.*, No. 70.]

71. If $J_n(x)$ be Bessel's function, show that

$$\int_0^{\infty} \frac{J_n(ax)}{x^{n-m}} \, dx = \frac{x^n}{\sqrt{\pi} 2^n \Gamma(n + \frac{1}{2})} \frac{\Pi\left(\frac{m-1}{2}\right)}{\Pi\left(n - \frac{m+1}{2}\right)} \cdot (2n+1 > 0 > m > -1). \\ \text{[MATH. TRIP., 1898.]}$$

CHAPTER XXIX.

VECTORS. THE COMPLEX VARIABLE. CONFORMAL REPRESENTATION.

1202. The Operative Symbol ι .

Let ι be defined as an operative symbol which, when applied to any straight line of given length, and lying in a given plane, has the effect of turning that line in the given plane about one of its extremities through a right angle in the positive direction of rotation, *i.e.* according to the customary convention, counter-clockwise.

Then, if OP be any length measured along the positive direction of the x -axis, ιOP will be an equal line OP_1 measured along the positive direction of the y -axis.

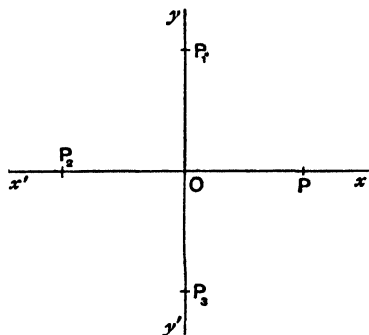

Fig. 340.

Now $\iota(OP)$, or, as we may write it in analogy with algebraic custom, $\iota^2 OP$, may be interpreted as the result of *doing to* ιOP what ι has done to OP ; *i.e.* OP_1 has been itself turned counter-

clockwise to a position OP_2 lying along the negative direction of the x -axis, the absolute lengths of OP_2 and OP_1 being each equal to OP .

Again, $\iota\{\iota(OP)\}$, i.e. ιOP_2 or $\iota^2 OP$ has turned OP_2 to the position OP_3 lying along the negative direction of the y -axis, the absolute lengths of OP_3 and OP being equal.

Finally, $\iota[\iota\{\iota(OP)\}]$, i.e. ιOP_3 or $\iota^3 OP$, has turned OP_3 to the original position OP .

1203. Interpretation of $\sqrt{-1}$.

Let us next consider for a moment the symbol $\sqrt{-1}$, or, as it is usually called, "the square root of -1 ," an expression with which the student has grown familiar in algebra, in the solution of quadratic equations, factorisation, etc.

Now all arithmetical quantities are either positive, zero or negative. There are no others. Their squares are all either positive or zero. There is no arithmetical quantity whose square is negative. But the definition of $\sqrt{-1}$ is that

$$\sqrt{-1}\sqrt{-1} = -1,$$

or conforming to the usual notation and language $(\sqrt{-1})^2 = -1$, and "the square of $\sqrt{-1}$ " is -1 . The logical inference is that $\sqrt{-1}$ is *not quantitative*.

But it is customary nevertheless to discuss and use such expressions in algebra as they arise there, and as they *obey the same fundamental laws of algebra* as are obeyed by ordinary arithmetical and algebraical quantities, viz. (1) the associative or distributive law, (2) the commutative law, (3) the index law, so long as they are combined with quantities which have magnitude only and no directive property.

Now, according to the usual Cartesian convention of sign to denote the relative direction of lines, if OP be regarded as a line drawn in the direction of the positive direction of the x -axis and OP_2 an equal line in the opposite direction, $OP_2 = -OP$.

$$\text{Thus} \quad \iota^2 OP = -OP = (\sqrt{-1})^2 OP.$$

We may therefore properly interpret $\sqrt{-1}$ as being identical with the operator ι , and therefore regard $\sqrt{-1}$, which is *not quantitative* at all, as being *operative* and having the property that it turns any line to which it may be applied through a

right angle counter-clockwise about one of its extremities. It is not therefore commutative as regards such expressions as have direction as well as magnitude, *i.e.* such expressions as are known as "vectors," in distinction from those which have magnitude only, to which the term "scalar" is applied.

1204. Definition of the Term "Vector."

The terms "scalar" and "vector" are due to Sir William Rowan Hamilton.

The definition of a "vector" given by Kelland and Tait (*Quaternions*, p. 6) is, "A vector is the representative of transference through a given distance in a given direction."

In the consideration of such operative symbols and vectors we retain, as is usual, the ordinary terms addition, subtraction, multiplication, division, though the interpretation of the results will differ in some respects from the results of the corresponding common processes as applied to scalar quantities.

If a rigid lamina be displaced without rotation from one position to another position in its own plane, points A, B, C, \dots of the lamina are transferred to new positions A', B', C', \dots , such that AA', BB', CC', \dots , are all equal and parallel. A knowledge of the length and direction of any one of them would be enough to fix the second position of the lamina relatively to its original position. They are all vector quantities and equivalent. That is, they are represented by the same vector. A vector is completely defined when its magnitude and its direction are known. No account is taken of its position. In this respect a vector differs from a force which needs further description, *viz.* a specification of the point of application.

Hence a force is fully defined by (1) its point of application,
(2) its representative vector.

In the case of the axis of a couple the only elements necessary for its description are (1) its magnitude, (2) its direction. Hence the axis of a couple is a pure vector and needs no further description, the vector being specified.

A vector is therefore represented graphically by drawing *any* straight line in the specific direction of the vector and of the specific length indicated in the description of the vector.

And all parallel lines of the same length, from whatever points they may be drawn, will equally represent the same vector.

Thus, the force acting at a definite point, a velocity, an acceleration, the axis of a couple are familiar examples of vector quantities, whilst speeds, moments, energy, horsepower, are scalar quantities.

1205. **Laws of Combination of the Operator ι .**

The operator ι obeys the "associative" or distributive law of algebra. For if we apply it to the sum of two lines OA , AB (Fig. 341) which lie in the same direction, say along the x -axis, it is immaterial whether we first add the lines together and then rotate the sum through a counter-clockwise right angle,

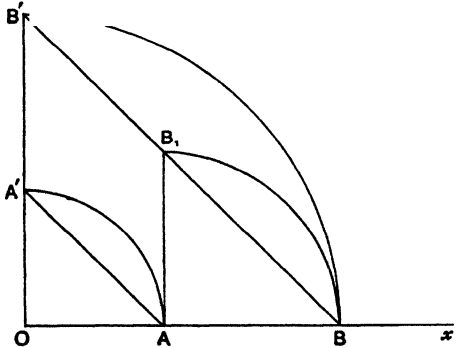

Fig. 341.

or whether we first rotate OA through a counter-clockwise right angle to OA' and do the same with AB , bringing it to the position AB_1 , and then transfer the result AB_1 parallel to itself to the new position $A'B'$. Thus

$$\iota(OA + AB) = \iota OB = OB' = OA' + A'B' = OA' + AB_1 = \iota OA + \iota AB.$$

1206. The same is obviously true if the operator ι be applied to the difference of two lines or to the algebraic sum of any number of lines in the same direction.

1207. Again, if a line be doubled or trebled or halved, etc., and then turned through a right angle counter-clockwise, the effect is the same as if we turn through a right angle first and then double, treble or halve, etc., i.e. $\iota(pOA) = pi(OA)$, p being numerical, so that ι obeys the commutative rule as regards numerical, that is scalar, quantities. But it is not commutative

with regard to the subject of its operation, *i.e.* we cannot write ιAB as $AB\iota$ any more than we can write $\log x$ as $x \log$.

Finally, ι satisfies *the index law of algebra*. For to turn a line n times in succession through a right angle in a counter-clockwise direction brings it into the same position as it would have had if turned in the same direction through n right angles at a single operation,

i.e. $\iota^n OA = \iota . \iota . \iota \dots$ to n operations. OA .

Thus ι satisfies all the fundamental laws of algebraic combination, except that it is not commutative with regard to any vector quantities upon which it is operative.

1208. The symbol AB , as denoting a line starting from A and terminating at B , drawn in a definite direction, may be

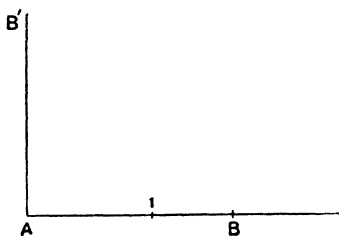

Fig. 342.

considered as a transference of a point from a position A to a position B , and may be regarded as a vector, or in fact itself as an operative symbol which, when applied to a unit line, *viz.* $AB(1)$, extends that unit in the specified direction in a numerical ratio of the absolute length of AB to unity.

When ι is applied to AB , there is further the rotation through a clock-wise right angle to the position AB' .

If AB be itself unity, then $AB' = \iota . (1) = \iota$, say, and ι may itself be regarded as a vector.

1209. Vector Addition.

The general idea of a vector being that it is an operator which has the effect of transferring a point through a given distance in a given direction, we understand that "vector PQ " means that the point P is to be transferred from P to Q through a distance represented by the length of PQ in the direction specified by the direction in which the line PQ is drawn from P . This being so, it follows that

$$\text{vector } PQ + \text{vector } QP = 0,$$

for there is no change in the position of P when the whole operation has been completed.

But vector PQ + vector QR = vector PR , where the second transference (Q to R) is not made necessarily in the same direction as the first (viz. P to Q). And we must understand by the sign of equality in such a relation as this, that it stands for the words "are together equivalent to."

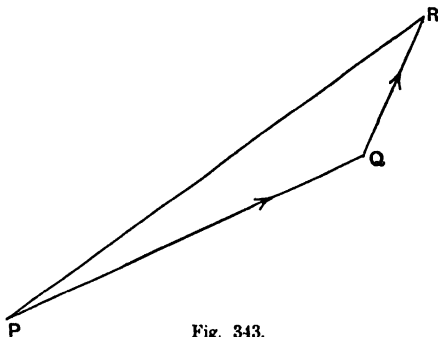

Fig. 343.

Vectors are therefore added by drawing a line from the initial position of the point to which the vectors are applied to its final position when it has been subjected successively to the transference indicated by each vector. The length and direction of this line *or of any equal and parallel line* fully represent the resultant vector.

It is clearly obvious that the order of the several transferees of the point is immaterial.

1210. Vector Subtraction.

If OP and OQ represent two vectors, complete the parallelogram $OPRQ$ and join OR . (See Fig 344.)

$$\begin{aligned} \text{Then vector } OP + \text{vector } OQ \\ &= \text{vector } OP + \text{vector } PR \\ &= \text{vector } OR. \end{aligned}$$

It follows that

$$\begin{aligned} \text{vector } OP &= \text{vector } OR - \text{vector } OQ \\ &= \text{vector } OR - \text{vector } PR \\ &= \text{vector } OR + \text{vector } RP. \end{aligned}$$

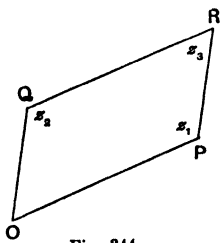

Fig. 344.

And the result of subtraction may therefore be obtained in the same way as that of addition, but drawing the subtractive vectors in the opposite direction to that in which they are drawn for addition.

Thus, if there be several vectors, OP , OQ , etc.,
 vector OP + vector OQ - vector OR - vector OS + vector OT
 = vector OP + vector PQ + vector QR + vector RS
 + vector ST = vector OT ,
 where PQ , QR , RS , ST are drawn respectively equal and
 parallel to OQ , RO , SO , OT , and in the same sense. (Fig. 345.)

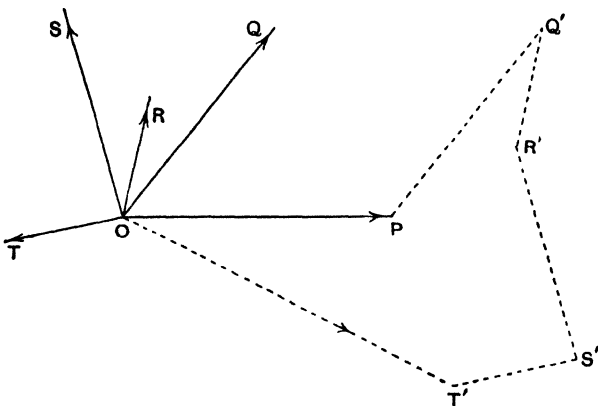

Fig. 345.

1211. Let us express the vector OP in terms of the Cartesian coordinates x , y of P referred to a pair of rectangular coordinate axes through O .

Let OA be unit length on the x -axis. Then if x units of length be laid off on the x -axis (OM), we may regard x as an operator (this time a mere numerical multiplier) which transfers a point from O ($0, 0$) to M ($x, 0$).

Similarly y regarded as an operator would transfer O to a point on the x -axis y units of length ($=ON'$) distant from O , and iy would be the vector which would transfer a point from O an equal distance along the y -axis to N , where $ON=ON'$.

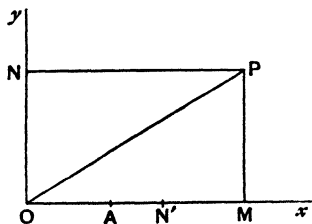

Fig. 346.

Thus, if z represent the complete operation $x + iy$ (Fig. 346),
 $z \equiv x + iy = \text{vector } OM + \text{vector } ON$
 $= \text{vector } OM + \text{vector } MP$
 $= \text{vector } OP$,

where P is the corner opposite to O of the rectangle, with OM , ON as adjacent sides, the coordinates of P being the numerical values of x and y .

1212. If the linear magnitude of OP be r units of length and θ the angular displacement of OP from Ox , we have

$$x + iy = r(\cos \theta + i \sin \theta), \text{ or, as we may write it, } re^{i\theta}.$$

This expression therefore, viz. $re^{i\theta}$, is a vectorial operative symbol which has the effect of increasing the unit length OA in the ratio $r : 1$ and then rotating it counter-clockwise through an angle θ radians.

Thus $r(\cos \theta + i \sin \theta)$ in itself has no quantitative meaning. It is an operator.

1213. **The Analytical View of Vector Addition** is as follows:

If, in Fig. 344,

$$z_1 = x_1 + iy_1 \equiv \text{vector } OP \text{ and } z_2 = x_2 + iy_2 \equiv \text{vector } OQ,$$

then $z_1 + z_2 = x_1 + x_2 + i(y_1 + y_2) \equiv z_3$, say, and $x_1 + x_2$, $y_1 + y_2$ are the Cartesian coordinates of the fourth angular point R of the parallelogram drawn with OP , OQ with adjacent sides.

$$\text{Thus } z_3 \equiv z_1 + z_2 \equiv \text{vector } OR,$$

and the rule can be extended to any number of vectors

$$z_1, z_2, z_3, \dots, z_n, \text{ where } z_r = x_r + iy_r.$$

If Z be the resultant vector of the addition,

$$Z = z_1 + z_2 + z_3 + \dots + z_n = \Sigma x + i \Sigma y,$$

where $\Sigma x = x_1 + x_2 + \dots + x_n$, $\Sigma y = y_1 + y_2 + \dots + y_n$.

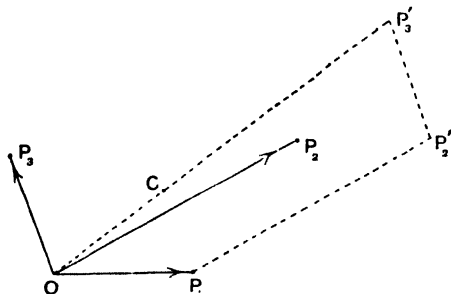

Fig. 347.

Clearly the direction of the vector Z passes through C , the centre of mean position $\left(\frac{\Sigma x}{n}, \frac{\Sigma y}{n}\right)$ of the several points $P_1, P_2,$

P_2, \dots , whose coordinates are $(x_1, y_1), (x_2, y_2), (x_3, y_3)$, etc., and its length is n times the distance of the centre of mean position from O , where n is the number of vectors added.

Exactly in the same way

$$z_1 - z_2 = x_1 - x_2 + i(y_1 - y_2),$$

$$z_1 - z_2 - z_3 + z_4 = (x_1 - x_2 - x_3 + x_4) + i(y_1 - y_2 - y_3 + y_4), \text{ etc.}$$

1214. In writing $z \equiv x + iy$, where x and y are the coordinates of a point P , we regard z as a vector which transfers a point from the origin O to P along the line OP .

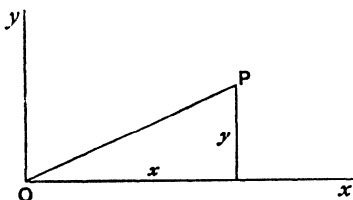

Fig. 348.

We may equally regard z as representing a label of the point P on the x - y plane, and it is then referred to as a complex variable. And in this sense every point in the plane may be represented by a complex variable, and conversely to every complex variable there is a corresponding point on the x - y plane.

When the point P moves in the plane, tracing a continuous path upon the plane, the relation between x and y is continuous, and the variation in the complex variable z is continuous.

1215. Modulus, Amplitude.

The letters r, θ represent the ordinary polar coordinates of the point $P(x, y)$, and $r = \sqrt{x^2 + y^2}$, $\theta = \tan^{-1}(y/x)$.

$\sqrt{x^2 + y^2}$ is called the modulus of the complex z , and written $|z|$ or mod. z .

$\tan^{-1}(y/x)$ is called the amplitude or argument of z , and written amp. z or arg. z .

The positive sign is always regarded as affixed to the modulus $\sqrt{x^2 + y^2}$, which is therefore a single-valued function of the real variables x and y , whilst $\tan^{-1}(y/x)$ is a many-valued function.

The expression $\cos \theta + i \sin \theta$ does not change its value when any even multiple of π , say $2\lambda\pi$, is added to θ , λ being an integer, so we may regard the amplitude as $2\lambda\pi + \theta$ or $2\lambda\pi + \tan^{-1}(y/x)$, where in this latter form we are to be understood to mean by $\tan^{-1}(y/x)$ the smallest positive value of the angle whose tangent is y/x , usually called the "principal value"

1216. Argand Diagram.

When any relation is assigned between y and x , the Cartesian graph of this relation is called the Argand diagram of the variation of z , and is the path of the extremity of the vector OP , whose changes are defined by the given relation.

1217. Vector Multiplication. Demoivre's Theorem.

We use the term multiplication for want of a better term and by analogy with algebraic multiplication. But what we are about to discuss is the effect of the operation of one vector operator upon another vector operator.

Let the operators be $r_1 e^{i\theta_1}$ and $r_2 e^{i\theta_2}$, the original subject of the first operation being a line of unit length lying along the x -axis.

The first operation $r_1 e^{i\theta_1} \cdot 1$ increases OA (a unit line on the x -axis) in the ratio $r_1 : 1$, and turns the resulting line through an angle θ_1 into a direction indicated in the figure by OP_1 .

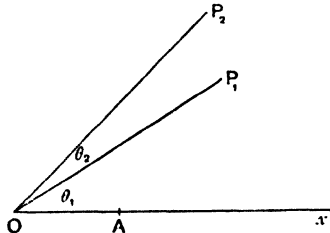

Fig 349.

The second operation $r_2 e^{i\theta_2}$ acting upon OP_2 does to OP_1 what $r_1 e^{i\theta_1}$ does to unity; viz. it increases OP_1 in the ratio of

$r_2 : 1$ and rotates the increased OP_1 , which has thus become $r_2 \cdot OP_1$, through a further angle θ_2 , to a position OP_2 .

Thus
$$r_2 e^{i\theta_2} [r_1 e^{i\theta_1} (1)] = OP_2.$$

The absolute length of OP_2 is $r_1 r_2$. The total angle $\widehat{xOP_2}$ is $\theta_1 + \theta_2$. But the operator which would increase $OA (=1)$ to a length $r_1 r_2$ and turn it through an angle $\theta_1 + \theta_2$ is

$$r_1 r_2 e^{i(\theta_1 + \theta_2)}.$$

So that $r_2 e^{i\theta_2} [r_1 e^{i\theta_1} (1)]$ is identical with $r_1 r_2 e^{i(\theta_1 + \theta_2)} (1)$, which is analogous to the ordinary rule of multiplication in algebra.

Further, it is obvious that the order of the two operations upon unity is immaterial, so that the operations are commutative with regard to each other. It will be observed that in the multiplication of two vectors the modulus of the product is the product of their moduli, and that the amplitude of their product is the sum of the amplitudes of the original vectors.

Again we may write the result as

$$\begin{aligned} & r_2(\cos \theta_2 + i \sin \theta_2)r_1(\cos \theta_1 + i \sin \theta_1)(1) \\ & \equiv r_2 r_1 [\cos (\theta_1 + \theta_2) + i \sin (\theta_1 + \theta_2)](1), \end{aligned}$$

which accords with what we get by the ordinary process of multiplication of $r_1(\cos \theta_1 + i \sin \theta_1)$ by $r_2(\cos \theta_2 + i \sin \theta_2)$.

If r_1 and r_2 be both taken unity, we obtain

$$(\cos \theta_2 + i \sin \theta_2)(\cos \theta_1 + i \sin \theta_1) \equiv \cos (\theta_2 + \theta_1) + i \sin (\theta_2 + \theta_1),$$

which means that to rotate a line of unit length through an angle θ_1 and then to rotate the result through a further angle θ_2 is identical with rotating the original line through a single angle $\theta_2 + \theta_1$, and this can obviously be generalised for any number of angles. Thus

$$\begin{aligned} & (\cos \theta_1 + i \sin \theta_1)(\cos \theta_2 + i \sin \theta_2)(\cos \theta_3 + i \sin \theta_3) \dots (\cos \theta_n + i \sin \theta_n) \\ & = \cos (\theta_1 + \theta_2 + \dots + \theta_n) + i \sin (\theta_1 + \theta_2 + \dots + \theta_n); \end{aligned}$$

and if we make the angles $\theta_1, \theta_2, \theta_3, \dots, \theta_n$ each $=\theta$, we get Demoiivre's Theorem for a positive integral index, viz.

$$(\cos \theta + i \sin \theta)^n = \cos n\theta + i \sin n\theta,$$

and the geometrical meaning of that theorem is thus shown.

1218. We may proceed to consider Demoiivre's Theorem for fractional and negative indices from the same point of view.

When n is not a positive integer but $=p/q$, say, where p and q are both positive integers, $(\cos \frac{p}{q}\theta + i \sin \frac{p}{q}\theta)^q$ is an operator which rotates a line of length unity through q successive angles, each $=\frac{p}{q}\theta$, counter-clockwise, and therefore through an angle $p\theta$ counter-clockwise, which is therefore the same as if we rotated a line of unit length through p successive angles, each equal θ ; and therefore the operators

$$\left(\cos \frac{p}{q}\theta + i \sin \frac{p}{q}\theta\right)^q \quad \text{and} \quad (\cos \theta + i \sin \theta)^p$$

are identical in their turning effect. We may therefore, consistently with the algebraic notation for indices, write

$$\cos \frac{p}{q} \theta + i \sin \frac{p}{q} \theta = (\cos \theta + i \sin \theta)^{\frac{p}{q}},$$

it being supposed that $(\cos \theta + i \sin \theta)^{\frac{p}{q}}$ represents an operator which, when repeated q times, gives the operator

$$(\cos \theta + i \sin \theta)^p.$$

Again, since cosines and sines are not altered if an integral multiple of 2π be added to their angle, and since to rotate a line through 2π is merely to bring it back into its original position, it will be seen that $\cos(\theta + 2\lambda\pi) + i \sin(\theta + 2\lambda\pi)$ is an operator which has the same effect as $\cos \theta + i \sin \theta$.

Hence the operator $\cos \frac{p}{q}(\theta + 2\lambda\pi) + i \sin \frac{p}{q}(\theta + 2\lambda\pi)$, having the same effect as $[\cos(\theta + 2\lambda\pi) + i \sin(\theta + 2\lambda\pi)]^{\frac{p}{q}}$, is the same as $(\cos \theta + i \sin \theta)^{\frac{p}{q}}$.

Also, the various angles $\frac{p}{q}(\theta + 2\lambda\pi)$ for different values of λ , viz. 0, 1, 2, ..., $q-1$, are such that no two differ by an integral multiple of 2π , and therefore that no two have the same sine and the same cosine. There are therefore q operators, viz.

$$\begin{aligned} &\cos \frac{p}{q} \theta + i \sin \frac{p}{q} \theta, \\ &\cos \frac{p}{q}(\theta + 2\pi) + i \sin \frac{p}{q}(\theta + 2\pi), \\ &\dots\dots\dots, \\ &\cos \frac{p}{q} \{\theta + 2(q-1)\pi\} + i \sin \frac{p}{q} \{\theta + 2(q-1)\pi\}, \end{aligned}$$

any of which, after q of its own operations, will have the same effect as $(\cos \theta + i \sin \theta)^p$, and there are no more. For if $\lambda = q$,

$$\cos \frac{p}{q}(\theta + 2q\pi) + i \sin \frac{p}{q}(\theta + 2q\pi) = \cos \frac{p}{q} \theta + i \sin \frac{p}{q} \theta,$$

which is the first of the above operators over again, and so on.

$\lambda = q+1$, $\lambda = q+2$, etc., give the second, third, etc., operators over again, so that other values of λ merely repeat one or other of the operators already obtained.

It is customary in the proof of Demoivre's Theorem to state this result in the form that $(\cos \theta + i \sin \theta)^{\frac{p}{q}}$ has q values and no more, these values being the above-mentioned expressions.

To complete the ordinary results of Demoivre's Theorem we still have to show that the operator $(\cos \theta + i \sin \theta)^n$ is the same as $\cos i\theta + i \sin n\theta$, where n is negative. Let $n = -m$.

Then $(\cos \theta + i \sin \theta)^{-m}$ is an operative symbol of inverse nature. Call its effect, when applied to unity, X .

Then $1 = (\cos \theta + i \sin \theta)^m X$, which, by what has preceded, is the same as $(\cos m\theta + i \sin m\theta) X$, where m is positive and either integral or fractional.

Now, to turn a line through a counter-clockwise angle $m\theta$, and then to turn the result clockwise through the same angle, restores it to its original position, so that

$$[\cos(-m\theta) + i \sin(-m\theta)][\cos m\theta + i \sin m\theta] X = X.$$

Hence

$$[\cos(-m\theta) + i \sin(-m\theta)](1) = X = (\cos \theta + i \sin \theta)^{-m}(1),$$

$$\text{i.e. } (\cos \theta + i \sin \theta)^n(1) = [\cos(-m)\theta + i \sin(-m)\theta](1) \\ = (\cos n\theta + i \sin n\theta)(1).$$

Hence it follows that the operators

$$(\cos \theta + i \sin \theta)^n \quad \text{and} \quad \cos n\theta + i \sin n\theta$$

are identical when n is a negative integer or a negative fraction, as well as when it is a positive integer or a positive fraction, and therefore their identity has been established for any commensurable value of n .

1219. Vector Division.

Let $z_1 \equiv r_1(\cos \theta_1 + i \sin \theta_1)$, $z_2 \equiv r_2(\cos \theta_2 + i \sin \theta_2)$.

Then we have to consider the effect of the operator z_1/z_2 .

Let $z_1 = z_2 z_3$, and let $z_3 \equiv r_3(\cos \theta_3 + i \sin \theta_3)$.

Then $z_1 \equiv r_2 r_3 \{ \cos(\theta_2 + \theta_3) + i \sin(\theta_2 + \theta_3) \}$,

and $z_1 \equiv r_1(\cos \theta_1 + i \sin \theta_1)$;

whence $r_1 = r_2 r_3$, $\theta_1 = \theta_2 + \theta_3$, and $r_3 = r_1/r_2$, $\theta_3 = \theta_1 - \theta_2$.

$$\text{Hence } z_3 \equiv \frac{r_1}{r_2} \{ \cos(\theta_1 - \theta_2) + i \sin(\theta_1 - \theta_2) \},$$

i.e. the "quotient" is a single vector whose modulus is the quotient of the moduli of the original vectors, and the amplitude of the quotient is the difference of their amplitudes.

1220. **Geometrical Meaning.**

Geometrically we may represent the result thus:

Suppose OP_2, OP_1 to be the original vectors z_2 and z_1 . Con-

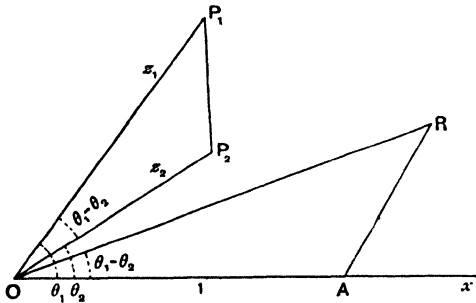

Fig. 350.

struct a triangle OAR similar to OP_2P_1 , with $OA=1$ lying along the x -axis.

Then $\frac{OR}{OA} = \frac{OP_1}{OP_2}$ in magnitude and $\hat{AOR} = \hat{P_2OP_1} = \theta_1 - \theta_2$.

Hence the vector OR has for modulus r_1/r_2 and for amplitude $\theta_1 - \theta_2$, i.e. the vector OR represents the "quotient" of the vectors OP_1, OP_2 .

Hence, summing up, it appears that addition, subtraction, multiplication, or division of vectors always leads to a single vector as the result of the operation.

1221. **Laws of Combination of Vectors.**

From what has been established for the addition, subtraction, multiplication and division of vector quantities, we have then the following rules as to the moduli and amplitudes of the results of these operations.

(1) The modulus of the sum, or difference, of two vectors is not greater than the sum of the moduli of the original vectors. For if OP_1, P_1P_2 represent two vectors to be added, their vector sum is represented by OP_2 and the absolute lengths of these lines are the several moduli of the vectors they represent.

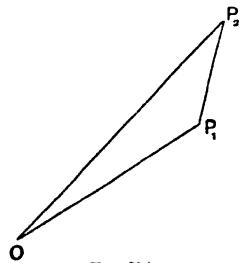

Fig. 351.

Hence we have mod. $OP_2 \nabla$ mod. $OP_1 +$ mod. P_1P_2 .

And similarly in the case of subtraction, or of the case when more than two vectors are combined into one by the process of addition or subtraction.

We may also see this fact analytically, thus: The modulus of $\Sigma\rho(\cos\theta + i\sin\theta)$ is $\sqrt{(\Sigma\rho\cos\theta)^2 + (\Sigma\rho\sin\theta)^2}$, and this is $\nabla \Sigma\rho$.

For if it were, we should have

$$\Sigma\rho^2 + 2\Sigma\rho_1\rho_2\cos(\theta_1 - \theta_2) > \Sigma\rho^2 + 2\Sigma\rho_1\rho_2,$$

i.e.

$$\Sigma\rho_1\rho_2\cos(\theta_1 - \theta_2) > \Sigma\rho_1\rho_2;$$

and as all the ρ 's are essentially positive and the cosines < 1 , this would be impossible. This includes the case when some of the vectors are subtracted, for in any such case $\pi - \theta$ may be supposed written instead of θ and the result treated as additive.

(2) The modulus of a product of complexes

$$\rho_1 e^{i\theta_1} \rho_2 e^{i\theta_2} \rho_3 e^{i\theta_3} \dots \rho_n e^{i\theta_n}$$

is obviously $\rho_1\rho_2\rho_3\dots\rho_n$, *i.e.* the product of the moduli, and the amplitude is $\theta_1 + \theta_2 + \theta_3 + \dots + \theta_n$, *i.e.* the sum of the amplitudes.

(3) The modulus of a quotient, viz. $\frac{\rho_1 e^{i\theta_1}}{\rho_2 e^{i\theta_2}}$, *i.e.* $\frac{\rho_1}{\rho_2} e^{i(\theta_1 - \theta_2)}$, is $\frac{\rho_1}{\rho_2}$,

i.e. the quotient of the moduli; and the amplitude is $\theta_1 - \theta_2$, *i.e.* the difference of the amplitudes.

1222. Revision of Definitions.

In dealing with the functionality of a complex variable $z \equiv x + iy$, it will be necessary to revise our ideas of continuity, of the nature of the dependence of one function upon another and of the assumption as to the existence of a limit as used in the formation of a Differential Coefficient.

Throughout the author's treatise on the Differential Calculus and up to the present point in this account of the Integral Calculus, there have been but few references to a function of a complex variable.

1223. **Functionality.** The idea of functionality has been that when one real quantity y depends upon another real quantity x , or upon a system of real quantities x_1, x_2, x_3 in such a manner as to assume a definite value when a definite

value is given to x , or when a definite system of values is given to the system of variables x_1, x_2, x_3, \dots , the quantity y is then said to be a function of x , or of the system x_1, x_2, x_3 , etc., as the case may be.

1224. Continuity.

Our idea of the continuity of a function $f(x)$ of a real independent variable x between any two assigned values of x , viz. $x=a$, the smaller, and $x=b$, the greater, has so far been that if x be made to change from $x=a$ to $x=b$, passing at least once through all real intermediate values between $x=a$ and $x=b$, whether these intermediate values when expressed by means of the ordinary system of numeration be represented by integers, fractions or incommensurable numbers, the function in question does not, as x passes through any intermediate value, suddenly change its value. And in such case its Cartesian graph has been regarded as capable of description by the motion of a material particle travelling along it from the point $\{a, f(a)\}$ to the point $\{b, f(b)\}$ without moving off the curve.

But such continuity does not also imply continuity as regards the slope of the tangent to the graph, or of continuity in the rate of bend of the curve at intermediate points.

1225. From a purely analytical point of view we may regard a function $f(x)$ as being continuous at a point $x=x_0$, if *when any infinitesimal change is made in x the consequent change in $f(x)$ is itself also an infinitesimal, and of at least as high an order.*

1226. We may put this condition into still another form, which will be more helpful in enunciating a condition for the continuity of a single-valued function of a *complex* variable later, viz. that for any assignable positive infinitesimal ϵ , however small, which may be chosen beforehand, it may be possible to choose another infinitesimal δ of no higher order of smallness than ϵ , so that if $x-x_0 < \delta$, then will $f(x) - f(x_0) < \epsilon$.

1227. To examine the geometrical meaning of this condition, imagine two lines AB, CD drawn parallel to the x -axis at an arbitrary infinitesimal distance ϵ apart, and let these lines cut the graph of the function $y=f(x)$ at points P, Q respectively.

Let the coordinates of P and Q be $x_0, f(x_0)$ and $x_0 + \delta, f(x_0 + \delta)$ respectively. Let P_1 be a point on the graph between P and Q , the coordinates of P_1 being $x, f(x)$. Let P_1N, QM be drawn at right angles to AB . Then $PN = x - x_0$, $PM = \delta$, $MQ = \epsilon$, $NP_1 = f(x) - f(x_0)$. Then if, however small MQ be taken, NP_1 is $< MQ$ for all positions of N from P to M , where PM is of no higher a degree of smallness than QM , there cannot be a break in the curve at the point P .

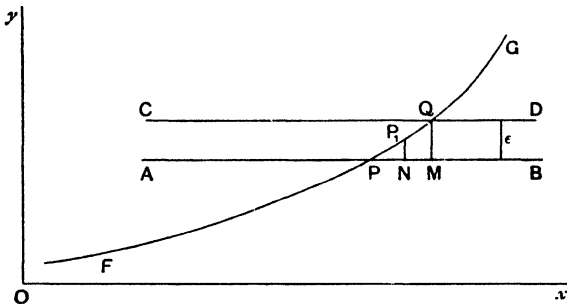

Fig. 352.

If this be so for all points x_0 between $x = x_1$ and $x = x_2$, $f(x)$ will be continuous for all values of x between these limits.

The figure is drawn for the case $f(x) > f(x_0)$.

1228. Definition of Functionality of a Complex Variable.

The nature and representation of an independent complex variable having been explained, we may proceed as in the case of a real variable to explain what is meant by the term Function as used in the case of complex variables. When one complex variable w is connected with another complex variable z in such a manner that for each value that may be assigned to z , w will itself take up a definite value, or a system of definite values, which can be derived from the value of z by some combination of the fundamental arithmetical rules, then w will be said to be a function of z , and will be denoted by an equation of the form $w = f(z)$ or $f(w, z) = 0$. Here z stands for $x + iy$, and x, y are themselves supposed to be real and may be regarded as the Cartesian coordinates of some arbitrary point referred to a given pair of rectangular axes in the z -plane.

If one value of x and one value of y give rise always to one value of w and no more, then w is said to be a *single-valued* or *uniform* function of z , i.e. of $x+iy$. Such functions as $w \equiv Az^n + Bz^{n-1} + \dots + C$, where n is a positive integer, $\sin z$, $\cos z$, $\tan z$, e^z , $e^z \sin z$, etc., are single-valued functions.

But if several values of w result from one value of x and one value of y , then w is said to be a *many-valued* or *multiple-valued* function of z .

Thus $w \equiv az^{\frac{p}{q}}$ is a q -valued function, for there are q separate q^{th} roots of z^p (p and q are supposed positive integers prime to each other). So also $w \equiv \sin^{-1}z$, $\tan^{-1}z$, $e^z \tan^{-1}z$, ... are multiple-valued functions of z , as also $w \equiv \log z$, for w may be written $\log(z e^{2i\lambda\pi}) = 2i\lambda\pi + \log z$, where λ is any integer.

1229. Continuity of a Single-Valued or Uniform Function of z .

Suppose that the point z ranges over a definite region Γ on the z -plane, and that z_0 is a definite point in this region. Let w be any single-valued function of z , which takes the value w_0 when z assumes the value z_0 . Then if, for any positive infinitesimal ϵ of however high an order which may be arbitrarily chosen, another small positive infinitesimal ξ be assignable, such that if $|z - z_0| < \xi$, we also have $|w - w_0| < \epsilon$; then w is a continuous function of z at $z = z_0$, and if this be true for all points z_0 which lie in the definite region Γ on the z -plane, w is said to be continuous for all such points, i.e. throughout the region.

1230. Geometrical Illustration.

Illustrating this geometrically, let P and P_0 be the two points z and z_0 in the z -plane, and let Q and Q_0 be the two corresponding points in the w -plane. Let Γ and Γ' be the corresponding regions on the two planes for which we are to discuss the continuity of the function. Draw a small circle with radius ξ and centre P_0 , and another small circle with radius ϵ and centre Q_0 . Then, if ξ can be so chosen that when P lies within the ξ -circle, Q lies within the ϵ -circle for all points P within the ξ -circle, when ϵ is arbitrarily chosen smaller than anything that can be conceived beforehand, however small; then w is said to be a continuous function

of z at the point z_0 , and for all points z_0 which lie within the region Γ for which the same is true.

If, then, for every small change in the modulus of either of two variables, there be a small change of at least the same

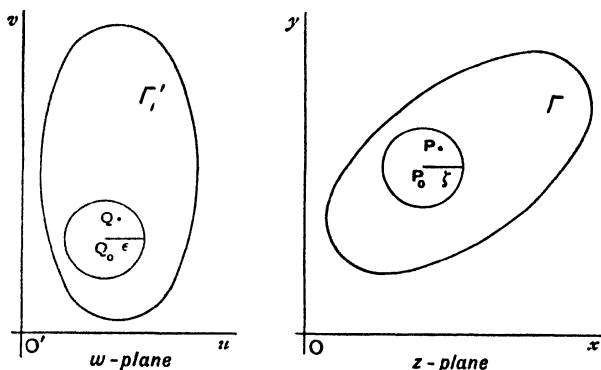

Fig. 3.3.

order of smallness in the modulus of the other, the second of these variables is a continuous function of the first.

1231. Positive Integral Powers of a Complex are continuous.

It follows from the definition of continuity above that all positive integral powers of z are continuous. Consider for instance $w = z^3$.

Then if w_0 and z_0 be corresponding points and $z - z_0 = \rho$,

$$w - w_0 = z^3 - z_0^3 = 3\rho z_0^2 + 3\rho^2 z_0 + \rho^3.$$

Hence

$$\begin{aligned} \text{mod.}(w - w_0) &\geq 3(\text{mod. } \rho)(\text{mod. } z_0^2) \\ &\quad + 3(\text{mod. } \rho^2)(\text{mod. } z_0) + (\text{mod. } \rho^3). \end{aligned}$$

Now if we take $(\text{mod. } \rho)$ small enough, say ξ , we can make the whole of the right-hand side less than any quantity assignable beforehand, however small.

Hence ξ can be chosen so that when

$$(\text{mod. } \rho) < \xi, \quad \text{mod.}(w - w_0) < \epsilon,$$

any assignable quantity, however small, and therefore w is a continuous function of z for all values of z in the z -plane.

Similarly we may show that any other positive integral power of z is continuous for all values of z .

1232. **Continuity of a Finite Series.**

If w, w', w'', \dots be a set of one-valued functions of a complex variable z , finite in number, and each continuous for values of z lying within a given contour on the z -plane, then their sum Σw will be continuous for values of z lying in that region.

For if w_0, w'_0, w''_0, \dots be the values of w, w', w'', \dots respectively, corresponding to $z=z_0$, it is by hypothesis possible to determine the positive quantities ξ, ξ', ξ'', \dots , so that for a given assigned small positive quantity ϵ ,

when $\text{mod.}(z-z_0) < \xi$, we have $\text{mod.}(w-w_0) < \epsilon$,

when $\text{mod.}(z-z_0) < \xi'$, we have $\text{mod.}(w'-w'_0) < \epsilon$, etc.;

and if $\bar{\xi}$, say, be the smallest of the quantities ξ, ξ', ξ'', \dots , then it is possible to find $\bar{\xi}$, so that when

$\text{mod.}(z-z_0) < \bar{\xi}$, we have $\Sigma \text{mod.}(w-w_0) < n\epsilon$,

where n is the number of functions; and therefore, since the modulus of a sum is not greater than the sum of the moduli, $\text{mod.}(\Sigma w - \Sigma w_0) < n\epsilon$ for all values of $n\epsilon$, however small. Hence Σw is a continuous function of z .

1233. As a case of this result any integral polynomial function of z ,

$$a_0 z^n + a_1 z^{n-1} + a_2 z^{n-2} + \dots + a_n,$$

is a continuous function of z , n being a positive integer.

1234. **Discontinuity.**

To examine the continuity of the function $w = \frac{1}{z-a}$ in the region near $z=a$ and elsewhere.

This function becomes ∞ when $z=a$, and therefore it is impossible to assign an infinitesimal ξ such that when

$$\text{mod.}(z-a) < \xi, \quad \text{mod.}\left(\frac{1}{z-a} - \frac{1}{0}\right)$$

is less than any assignable quantity ϵ , and the function is discontinuous at $z=a$.

But at any other point z_0 in the z -plane the function is continuous.

For if $z = z_0 + h$, where $z_0 \neq a$,

$$\text{mod.}\left(\frac{1}{z_0+h-a} - \frac{1}{z_0-a}\right) = \text{mod.}\left[\frac{-h}{(z_0-a)(z_0+h-a)}\right],$$

which can be made as small as we like by sufficiently diminishing mod. h , *i. e.* by sufficiently diminishing mod. $(z - z_0)$.

1235. CONFORMAL REPRESENTATION.

Let us consider the equation $w = f(z)$.

We have $z \equiv x + iy$, and if $f(z)$ be separated into its real and unreal parts, say $f_1(x, y) + if_2(x, y)$, we may write w in the form $u + iv$, where

$$u = f_1(x, y) \quad \text{and} \quad v = f_2(x, y).$$

If we superimpose a relation $y = F(x)$ between x and y , we shall have, by elimination of x between the equations,

$$u = f_1\{x, F(x)\}, \quad v = f_2\{x, F(x)\},$$

a resultant relation of the form $v = \phi(u)$.

And to represent this to the eye we shall require two sets of rectangular axes, not necessarily in the same plane. Call these planes the z -plane and the w -plane.

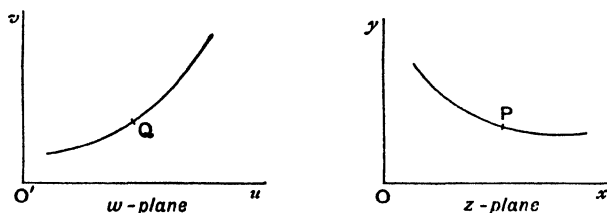

Fig. 354.

Then when a point $P(x, y)$ traverses the graph of $y = F(x)$, in the z -plane the corresponding point $Q(u, v)$ will traverse the graph of $v = \phi(u)$ in the w -plane.

When no such relation as $y = F(x)$ is superimposed connecting the values of x and y , there will be no relation between the coordinates u and v of the corresponding point in the w -plane.

If there be more than one value of w for a single value of z , then each value of w is said to constitute a "branch" of w . For instance, in the equation $w^n = z$ the function w is many-valued, and is said to have n branches. (See Art. 1256.)

Such a representation by means of the z -plane and the w -plane of the associated z and w -loci is generally spoken of as a "conform" or "conformal" representation of these loci;

and it will be remembered that, u and v being conjugate functions of x and y , the curves $u=\text{const.}$ and $v=\text{const.}$ cut each other orthogonally. (*Diff. Calc.*, Art. 195.)

1236. Two Important Cases.

There are two very well-known cases of conformal representation in Elementary Conic Sections.

1. If $w = a \cos z = X + \iota Y$ say (see Art. 590),

$$X + \iota Y = a \cos(x + \iota y) = a(\cos x \cosh y - \iota \sin x \sinh y),$$

$$X = a \cos x \cosh y, \quad Y = -a \sin x \sinh y;$$

$$\therefore \frac{X^2}{a^2 \cosh^2 y} + \frac{Y^2}{a^2 \sinh^2 y} = 1 \dots\dots (\alpha) \quad \text{and} \quad \frac{X^2}{a^2 \cos^2 x} - \frac{Y^2}{a^2 \sin^2 x} = 1. \dots\dots (\beta)$$

And for z -loci of the form $y = \text{constant}$ we have confocal ellipses in the w -plane, whilst for loci of the form $x = \text{constant}$ in the z -plane we have confocal hyperbolae in the w -plane; and the ordinary property of orthogonality of these two families of conics manifestly follows.

2. The other case is $w = a \tan z$,

$$\text{i.e.} \quad x + \iota y = \tan^{-1} \frac{X + \iota Y}{a} \quad \text{and} \quad x - \iota y = \tan^{-1} \frac{X - \iota Y}{a};$$

$$\text{whence} \quad 2x = \tan^{-1} \frac{2aX}{a^2 - X^2 - Y^2}; \quad 2y = \tanh^{-1} \frac{2aY}{a^2 + X^2 + Y^2},$$

$$\text{i.e.} \quad a^2 - X^2 - Y^2 = 2aX \cot 2x \quad \text{and} \quad a^2 + X^2 + Y^2 = 2aY \coth 2y,$$

$$\text{i.e.} \quad (X + a \cot 2x)^2 + Y^2 = a^2 \operatorname{cosec}^2 2x$$

$$\text{and} \quad X^2 + (Y - a \coth 2y)^2 = a^2 \operatorname{cosech}^2 2y,$$

so that for the z -loci $x = \text{const.}$ and $y = \text{const.}$ the w -loci are a pair of families of coaxial circles, the two families of course being orthogonal to each other.

Other examples will be discussed in due course.

1237. Case of Non-Existence of a Limit.

In the definition of a differential coefficient of a function of a real variable as $L_{h \rightarrow 0} \frac{f(x+h) - f(x)}{h}$, it was presupposed that such a limit existed, and this supposition was sufficient for the time.

It is possible, however, for a function to exist for which the expression in question, viz. $\frac{f(x+h) - f(x)}{h}$, does not approach any determinate limit, finite or infinite, when h is indefinitely diminished, although such a function may be continuous.

For instance, let us consider the case of a function of x in which the infinitesimally close ordinates of the graph termi-

nate at points $P_1, P_2, P_3, P_4, \dots$, such as shown in the figure, the consecutive angles $P_1\hat{P}_2P_3, P_2\hat{P}_3P_4, P_3\hat{P}_4P_5$, etc., being alternately $<$ and $>$ π , and the nature of the function being such that each of the elements of the graph between these successive ordinates can again be themselves divided up into an infinite number of portions having the same peculiarity,



Fig. 355.

the distances between the new subdividing ordinates being infinitesimals of a higher order than the infinitesimal distances between the first set, and so on with further subdivisions. It will be clear that the direction of the line which we please to call the tangent at any point P will depend upon the order of the infinitesimal closeness of the ordinates, and may or may not have a limiting position.

1238. Weierstrass' Example.

An example is given by Weierstrass, viz. the case of

$$y = \sum_0^{\infty} b^n \cos a^n \pi x,$$

where a is an odd positive integer, b positive and < 1 , and $ab > 1 + \frac{3\pi}{2}$, which, though continuous at every point, has no differential coefficient determinable at any point. See Harkness and Morley, *Theory of Functions*, p. 59, or Forsyth, *Theory of Functions*, pp. 133-136, where the student will find the case discussed at length.

1239. Differentiation of a Function of a Complex Variable.

It has been seen that in order to define a complex variable $z (\equiv x + iy)$, the values of x and y must both be separately

assigned. They are independent of each other. Any law connecting them may be arbitrarily assigned. But so long as such law is unassigned z depends upon a doubly infinite system of values. But when x and y have once been assigned, then z becomes known. That is, to a definite value of z corresponds a definite point whose Cartesian coordinates are x, y on the x - y plane, and this point it is usual to designate as the point z .

Conversely to any value specified for z , a definite specification of x and y is implied. When z changes its value to z' , and in consequence x and y change to x' and y' , say, the value of z' does not depend in any way upon the manner in which the point x, y has travelled to the point x', y' , no relation having been assigned to hold between x and y . Hence the vector $z' - z$ is independent of any particular law which may be arbitrarily assigned, connecting x and y . If w be any single-valued function of z , defined as in Art. 1228, and expressed as $w = f(z)$, then when z becomes z' , w becomes w' , where $w' = f(z')$. Thus $w' - w = f(z') - f(z)$, and is independent of any particular path by which z' is made to approach z on the x - y plane.

Suppose the points z' and z to be infinitesimally near points on the z -plane, and let z' be written $z + \delta z$, and w' be written $w + \delta w$. Then $\delta w = f(z + \delta z) - f(z)$.

We shall define $\text{Lt} \frac{f(z + \delta z) - f(z)}{\delta z}$, when δz is made indefinitely small, as the differential coefficient of $f(z)$ or w with regard to z , *provided such limit exists independent of the way in which the point $z + \delta z$ is made to approach the point z indefinitely closely*, that is, independent of any particular path which may be assigned to pass through the points x, y and $x + \delta x, y + \delta y$.

We shall denote this limit by $\frac{dw}{dz}$ or $f'(z)$.

It follows that $\frac{dw}{dz}$ is independent of $\frac{dy}{dx}$ by definition.

1240. Before assuming the functional relation $w = f(z)$, but assuming that u and v are functions of x and y , and that $w \equiv u + iv$ and $z \equiv x + iy$, we might enquire what relation, if

any, must subsist between u and v in order that $Lt \frac{\delta w}{\delta z}$ should be independent of $Lt \frac{\delta y}{\delta x}$.

Proceeding from this point of view, we have

$$\begin{aligned} Lt \frac{\delta w}{\delta z} &= \frac{dw}{dz} = \frac{d(u+iv)}{d(x+iy)} = \frac{u_x dx + u_y dy + i(v_x dx + v_y dy)}{dx + i dy} \\ &= \frac{(u_x + iv_x) dx + i(-iv_y + v_y) dy}{dx + i dy}; \end{aligned}$$

and in order that this should be independent of $\frac{dy}{dx}$, we must have

$$u_x + iv_x = -iv_y + v_y,$$

i.e. $u_x = v_y$ and $u_y = -v_x$;

whence $u_{xx} + u_{yy} = 0$ and $v_{xx} + v_{yy} = 0$.

So that u and v must be conjugate functions of x and y satisfying the Laplacian equation $\frac{\partial^2 \phi}{\partial x^2} + \frac{\partial^2 \phi}{\partial y^2} = 0$, whose general solution is $\phi = F_1(x+iy) + F_2(x-iy)$, where F_1 and F_2 are arbitrary functional forms. It appears therefore that in putting

$$w = f(z), \quad \text{i.e. } u+iv = f(x+iy),$$

the property of independence of $\frac{dw}{dz}$ and $\frac{dy}{dx}$ is implied; and

further, that $\frac{dw}{dz} = u_x + iv_x$ or $-iv_y + v_y$, i.e. $\frac{u_y + iv_y}{i}$.

Also it is understood in defining $\frac{dw}{dz}$ as $Lt_{\delta z=0} \frac{f(z+\delta z) - f(z)}{\delta z}$, provided *such limit be existent*, that the function $f(z)$ is continuous at all points within a small circle on the x - y plane, of which z is the centre, and whose radius is not less than the modulus of δz . Also it is presumed that either $f(z)$ is a single-valued function of z , or if not so, that in passing from the point $z+\delta z$ to the point z , we adhere to the same branch of w .

For example, in the case $w^2 = z$, so that $w = \sqrt{z}$ or $-\sqrt{z}$, it is to be understood that we keep to the same sign in both cases, viz. $w = \sqrt{z}$ and $w + \delta w = \sqrt{z + \delta z}$, or $w = -\sqrt{z}$ and $w + \delta w = -\sqrt{z + \delta z}$, and that the gradation of values from \sqrt{z} to $\sqrt{z + \delta z}$ is a continuous gradation.

1241. The Standard Forms.

It will be found that the ordinary "standard forms" of differentiation still hold good when the independent variable z is a complex. That is, we still have

$$\frac{dz^n}{dz} = nz^{n-1}, \quad \frac{d}{dz} \sin z = \cos z, \quad \frac{d}{dz} \log z = \frac{1}{z}, \text{ etc.}$$

Also the rules for the differentiation of a product or a quotient still hold good, viz. the same for complex variables as for real ones.

And in due course it will be shown that Taylor's expansion of $f(z+h)$ also holds.

1242. Geometrical Meaning of Differentiation.

Let OP, OQ represent the vectors z and $z + \delta z$ on the z -plane, and $O'P', O'Q'$ the corresponding vectors w and $w + \delta w$, as determined from the equation $w = f(z)$ on the w -plane.

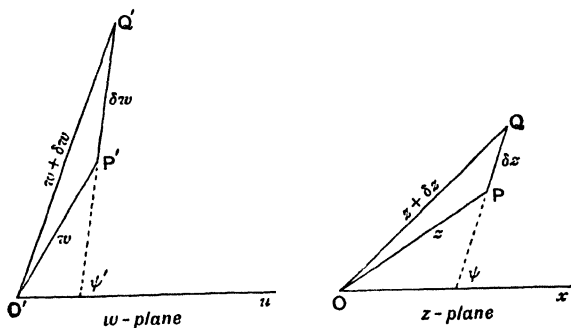

Fig. 356.

Then PQ and $P'Q'$ respectively represent the vectors δz and δw .

Then what we search for and represent by the symbol $\frac{dw}{dz}$, being $\text{Lt} \frac{\delta w}{\delta z}$, is the limit of the ratio of the two vectors $P'Q', PQ$, when PQ is indefinitely diminished. This is therefore itself a vector quantity; and if the tangents to the z -path and the w -path make respectively angles ψ and ψ' with the axes Ox and $O'u$, the modulus of this vector is $\text{Lt} \left| \frac{\delta w}{\delta z} \right|$, and the amplitude is $\psi' - \psi$ (Art. 1220).

1243. Zeros, Infinities, Singularities of a Function.

When $w=f(z)$, and a value of z , say $z=a$, gives w a zero value, $z=a$ is said to be a "root" of $w=0$, or a "ZERO" of the function w .

When $z=a$ gives an infinite value to w , $z=a$ is called an INFINITY of the function.

The equations $f(z)=0$, $\frac{1}{f(z)}=0$ therefore respectively give the ZEROS and the INFINITIES of the function $f(z)$.

A single-valued or uniform function $f(z)$ which possesses a differential coefficient, and which is finite and continuous for all values of z for points within and upon the boundary of a definite region Γ of the plane of $x-y$ is said to be "SYNECTIC" for that region.

1244. If an infinity of the function be such that at all points in the immediate neighbourhood of the infinity the reciprocal of the function, viz. $\frac{1}{f(z)}$, is synectic, the point in question is said to be a "POLE" of the function.

The infinities of a function, whether poles or otherwise, are generally referred to as the "singularities" of the function. A singularity is classed as "ACCIDENTAL" or "ESSENTIAL" according as $\frac{1}{f(z)}$ has or has not a determinate zero value at the point in question, *independent of the path by which the point z is made to approach the assigned position*. Thus, $w \equiv \frac{1}{z}$ has an *accidental* singularity, viz. a pole, at $z=0$; for its reciprocal, viz. $z (\equiv x+iy)$, becomes zero when x and y become zero independently of any relation which might be superimposed between x and y . But $w=e^{\frac{1}{z}}$ has an *ESSENTIAL* singularity at $z=0$, for if z approaches a zero value by a path along the positive part of the x -axis, the reciprocal of the function, viz. $\frac{1}{e^{\frac{1}{z}}}$, approaches the value $\frac{1}{e^{+\frac{1}{z}}} = \frac{1}{e^{+\infty}}$, that is $\frac{1}{\infty}$ or zero; but if the approach be along the negative portion of the x -axis, $\frac{1}{e^{\frac{1}{z}}}$ approaches the value $\frac{1}{e^{-\frac{1}{z}}}$, i.e. $\frac{1}{e^{-\infty}}$ or e^{∞} , i.e. ∞ .

1245. The term Synectic is due to CAUCHY. The terms HOLOMORPHIC or INTEGRAL are also used to denote the possession by a function of the same properties. The former term is due to BRIOT and BOUQUET, the latter to HALPHEN. These terms are applied to describe such functions in distinction from functions which the same authors respectively term "MEROMORPHIC" or "FRACTIONAL," and which are characterised by the possession of singularities at a point or at points within the contour, viz. poles or ESSENTIAL singularities.

Thus $\sin z$, $\cos z$, $\exp z$, are synectic or holomorphic functions of z for all points of the z -plane; whilst $\frac{\sin z}{z-a}$, $\cot z$, etc., are meromorphic at certain regions of the plane by virtue of the existence of the pole at $z=a$ in the first case, or of the poles at the zeros of $\sin z$ in the second case.

At points of the region Γ of the z -plane, for which w takes a single definite value as z approaches such a point independent of the path of approach, the function is said to behave "regularly," and such points are said to be "ORDINARY" or "REGULAR" points.

1246. For details as to the tests for the nature of singularities and other matters of this nature, we have no space, and must refer the student to Forsyth, *Theory of Functions*, pages 16, 17, 53, 66, etc.

1247. Isogonal Property of a Conformal Representation.

Suppose that the point P , (z), in the z -plane corresponds to the point P' , (w), in the w -plane, and that Q_1 , Q_2 , (z_1 and z_2),

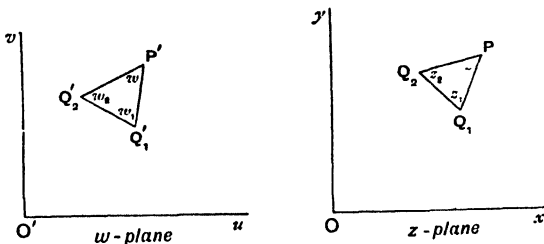

Fig. 357.

are adjacent points to z in the z -plane, whilst Q_1' , Q_2' , (w_1 and w_2), are the corresponding points in the w -plane;

then, since the value of $\frac{dw}{dz}$ is to be independent of the direction of the differential element dz , we must have

$$Lt \frac{w-w_1}{z-z_1} = Lt \frac{w-w_2}{z-z_2},$$

when the vectors $z-z_1$, $z-z_2$ are infinitesimally small.

$$\text{Hence} \quad Lt \frac{w-w_1}{w-w_2} = Lt \frac{z-z_1}{z-z_2}.$$

Let the moduli and amplitudes of $z-z_1$, $z-z_2$, $w-w_1$, $w-w_2$ be respectively (ρ_1, θ_1) , (ρ_2, θ_2) , (ρ_1', θ_1') , (ρ_2', θ_2') .

Then in the limit

$$\frac{\rho_1'}{\rho_2'} e^{i(\theta_1' - \theta_2')} = \frac{\rho_1}{\rho_2} e^{i(\theta_1 - \theta_2)}, \quad \text{whence} \quad \frac{\rho_1'}{\rho_2'} = \frac{\rho_1}{\rho_2}, \quad \theta_1' - \theta_2' = \theta_1 - \theta_2.$$

$$\text{i.e.} \quad P'Q_1' : P'Q_2' = PQ_1 : PQ_2 \quad \text{and} \quad Q_1'\hat{P}'Q_2' = Q_1\hat{P}Q_2.$$

Hence, in any such representation, infinitesimal triangles, and therefore any other *elements*, preserve their similarity, and angles are unaltered in such a transformation. But the moduli of z and w vary with the position of P , and therefore the ratio of such infinitesimal elements is not preserved as a constant in general throughout any *finite* regions in the two planes.

1248. It is also to be noted that it has been assumed that the ratios $(w-w_1)/(z-z_1)$, $(w-w_2)/(z-z_2)$ do not become zero or infinite within an infinitesimal distance of the points P , P' considered. That is to say, that the theorem is not to be applied at points for which $\frac{dw}{dz}$ is zero or infinite.

1249. For the reasons given above a conformal representation is said to be *Isogonal*. If, for instance, any two z -paths cut at an angle α the corresponding w -paths also cut at the same angle α . To orthogonal curves on the z -plane correspond orthogonal curves on the w -plane; and as a particular case straight lines parallel to the axes on the one plane correspond to curves which cut at right angles on the other plane. To two curves which touch one another in the one plane correspond curves which touch on the other plane, but

as straight lines do not in general correspond to straight lines in the conformal representation, linear tangents do not become linear tangents, but curvilinear tangents.

1250. **Ratio of Elements of Area.**

Again, the ratio of the infinitesimal areas $P'Q_1'Q_2'$, PQ_1Q_2 is that of the squares of the moduli of dw and dz , i.e. if

$$z = x + iy \quad \text{and} \quad w = u + iv = f(x + iy),$$

$$\frac{\text{the } w\text{-element of area}}{\text{the } z\text{-element of area}} = \frac{|dw|^2}{|dz|^2} = \frac{|du + i dv|^2}{|dx + i dy|^2}.$$

$$\frac{|u_x dx + u_y dy + i(v_x dx + v_y dy)|^2}{|dx + i dy|^2} = \frac{(u_x dx + u_y dy)^2 + (v_x dx + v_y dy)^2}{dx^2 + dy^2}$$

and since $u_x = v_y$ and $u_y = -v_x$, this ratio becomes

$$u_x^2 + v_x^2 \text{ or } u_y^2 + v_y^2 \text{ or } u_x^2 + u_y^2 \text{ or } v_x^2 + v_y^2 \text{ or } u_x v_y - u_y v_x,$$

i.e. $J \begin{pmatrix} u, v \\ x, y \end{pmatrix}$, where J is the Jacobian of u, v with regard to x, y . Or again, it may be written as

$$(u_x + iv_x)(u_x - iv_x), \quad \text{i.e. } f'(x + iy)f'(x - iy).$$

Thus the ratio of the corresponding elements at u, v and at x, y is that of $J \begin{pmatrix} u, v \\ x, y \end{pmatrix} : 1$.

It follows of course at once that the inverse ratio is

$$J' \begin{pmatrix} x, y \\ u, v \end{pmatrix} : 1,$$

and therefore that $JJ' = 1$, as is otherwise well known. (*Diff. Calc.*, Art. 540.)

We may, if desirable to use a polar form for the moduli of dz and dw , write $|dz|^2 = ds^2$ or $dr^2 + r^2 d\theta^2$, and for

$$|dw|^2 = u_x^2 + v_x^2 \quad \text{or} \quad u_y^2 + v_y^2,$$

we may write

$$|dw|^2 = \left(\frac{\partial u}{\partial r}\right)^2 + \left(\frac{\partial v}{\partial r}\right)^2 \quad \text{or} \quad \frac{1}{r^2} \left(\frac{\partial u}{\partial \theta}\right)^2 + \frac{1}{r^2} \left(\frac{\partial v}{\partial \theta}\right)^2, \text{ etc.}$$

1251. **Connection of the Curvatures.**

The curvatures of the companion w and z curves may be connected as follows.

Let ρ and ρ' be the radii of curvature at corresponding points P, P' .

Then $|dz|$ and $|dw|$ are the lengths of the corresponding infinitesimal arcs.

Let ψ and ψ' be the corresponding angles which the two tangents make respectively with the x and u axes, θ and θ' the polar angular coordinates of the points and ϕ , ϕ' the angles between the tangents at P and P' and their respective polar radii r , r' .

Then $z = re^{i\theta}$, $w = r'e^{i\theta'}$, $\psi = \theta + \phi$, $\psi' = \theta' + \phi'$, whilst $\theta = \text{amp. } z$ and $\theta' = \text{amp. } w$ are the respective amplitudes.

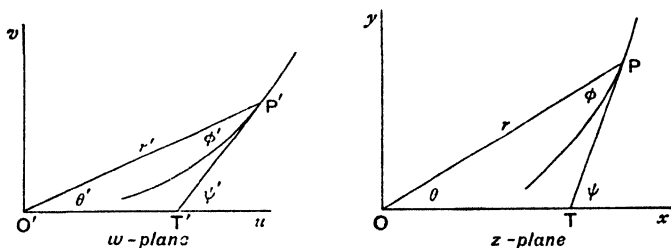

Fig. 358.

Then, since $w = f(z)$, we have $r'e^{i\theta'} = f(re^{i\theta})$,
and $dr'e^{i\theta'} + ir'e^{i\theta'} d\theta' = f'(re^{i\theta})(dre^{i\theta} + ire^{i\theta} d\theta)$.

Put $f'(re^{i\theta}) \equiv Re^{i\Theta}$, say, R and Θ being the modulus and amplitude of $f'(re^{i\theta})$, i.e. $\Theta \equiv \text{amp. } f'(z)$.

Then, since $dr' = ds' \cos \phi'$, $r'd\theta' = ds' \sin \phi'$, etc., we have

$$\sqrt{dr'^2 + r'^2 d\theta'^2} e^{i\theta'} e^{i\phi'} = \sqrt{dr^2 + r^2 d\theta^2} e^{i\theta} e^{i\phi} Re^{i\Theta};$$

that is $|dw| e^{i\psi'} = |dz| Re^{i(\psi+\Theta)}$,

whence

$$|dw| = R|dz| \text{ or } |f'(z) dz| \text{ and } \psi' - \psi = \Theta = \text{amp. } f'(z),$$

whence $d\psi' - d\psi = d \text{ amp. } f'(z)$;

and since $\rho = \frac{|dz|}{d\psi}$ and $\rho' = \frac{|dw|}{d\psi'}$, we obtain

$$\frac{|dw|}{\rho'} - \frac{|dz|}{\rho} = d \text{ amp. } f'(z)$$

or $\frac{|f'(z) dz|}{\rho'} - \frac{|dz|}{\rho} = d \text{ amp. } f'(z)$(A)

In many cases of conformal representation, the z -curve is taken as one of simple nature, usually a well-known curve,

and the w curve is often one which is of more or less complicated nature, and the labour of applying the ordinary formulæ to obtain ρ' in such cases, may generally be avoided by the use of this connection between the curvatures.

1252. Illustrations.

Ex. 1. Taking $aw = z^2$, where a is real and positive, we have $ar'e^{i\theta} = r^2e^{2i\theta}$, whence $ar' = r^2$, $\theta' = 2\theta$.

Here

$$f(z) = \frac{z^2}{a}, \quad f'(z) = \frac{2z}{a}, \quad \text{amp. } f(z) = \text{amp. } \frac{2r}{a} e^{i\theta} = \theta, \quad d \text{amp. } f'(z) = d\theta,$$

$$|dz| = \sqrt{dr^2 + r^2 d\theta^2}, \quad |f'(z) dz| = \left| \frac{2z}{a} \right| \cdot |dz| = \frac{2r}{a} \cdot |dz|;$$

$$\therefore \frac{2r}{a\rho'} - \frac{1}{\rho} = \frac{d\theta}{\sqrt{dr^2 + r^2 d\theta^2}} = \left\{ r^2 + \left(\frac{dr}{d\theta} \right)^2 \right\}^{-\frac{1}{2}}.$$

To verify in the simplest case, take the z -curve as $r = a$; then

$$\rho = a, \quad \frac{dr}{d\theta} = 0; \quad \therefore \frac{2}{\rho'} - \frac{1}{a} = \frac{1}{a}, \quad \text{i.e. } \rho' = a,$$

which is obviously correct. For if $r = a$, $r' = \frac{a^2}{a} = a$, and the w -curve is also a circle of radius a but described twice as fast as the z -circle, since $\theta' = 2\theta$, and therefore is traced twice over for one tracing of the z -circle.

Ex. 2. Consider $w = +\sqrt{a^2 + bz}$, a and b being both real. We have

$$r'e^{i\theta} = \sqrt{a^2 + bre^{i\theta}} = \sqrt{a^4 + 2a^2br \cos \theta + b^2r^2} e^{i \tan^{-1} \frac{br \sin \theta}{a^2 + br \cos \theta}},$$

i.e. $r'^4 = a^4 + 2a^2br \cos \theta + b^2r^2$ and $\tan 2\theta' = \frac{br \sin \theta}{a^2 + br \cos \theta}$.

Also $dw = f'(z) dz = b dz / 2\sqrt{a^2 + bz} = \frac{b}{2r'} e^{-i\theta} dz,$

$$|dw| = \frac{b}{2r'} |dz|, \quad |dz| = \sqrt{dr^2 + r^2 d\theta^2}, \quad \text{amp. } f'(z) = -\theta',$$

and $d\theta' = \{a^2b \sin \theta dr + br(a^2 \cos \theta + br)d\theta\} / 2r'^4;$

whence

$$\frac{b}{2r'\rho'} - \frac{1}{\rho} = - \left\{ a^2b \sin \theta \frac{dr}{d\theta} + br(a^2 \cos \theta + br) \right\} / 2r'^4 \sqrt{\left(\frac{dr}{d\theta} \right)^2 + r^2} \dots, \quad (1)$$

which will be the general formula connecting the curvatures of the z and w curves in any transformation by means of $w = \sqrt{a^2 + bz}$.

For instance, take the z -curve to be the circle $r = c$. Then the w -curve is a Cassinian oval. For $r'^2 e^{2i\theta} = a^2 + bce^{i\theta}$, i.e.

$$r'^2 \cos 2\theta' = a^2 + bc \cos \theta, \quad r'^2 \sin 2\theta' = bc \sin \theta,$$

and

$$r'^4 - 2a^2r'^2 \cos 2\theta' + a^4 = b^2c^2 \quad [\text{see } \textit{Diff. Calc.}, \text{ Art. 458}],$$

that is, if S, H be the foci and P any point on the curve, $SP \cdot HP = bc$.

Putting $r = \rho = c$, $\frac{dr}{d\theta} = 0$, in Equation (1), and substituting for $\cos \theta$,

$$\frac{b}{2r'\rho'} - \frac{1}{c} = -\frac{b}{2r'^4} \left(bc + a^2 \frac{r'^2 \cos 2\theta' - a^2}{bc} \right) = -\frac{r'^4 - a^4 + b^2 c^2}{4cr'^4},$$

i.e. $\rho' = 2bcr'^3 / (3r'^4 + a^4 - b^2c^2)$, for the Cassinian.

If $a^2 = bc$, we have the case of Bernoulli's Lemniscate, and $\rho' = 2a^2/3r'$.

In the case just considered, it will be seen that since

$$(w-a)(w+a) = bz,$$

we have

$$\text{mod.}(w-a) \text{ mod.}(w+a) = b \text{ mod. } z;$$

and therefore that if $\text{mod. } z$ be constant, i.e. if the z curve be chosen as above to be a circle of radius c and centre at the origin, the corresponding w -curve has the property that the product of its bi-focal radii SP , HP is constant, the coordinates of the foci S , H being $(a, 0)$ and $(-a, 0)$, and therefore it is one of the class of the Cassinian ovals $r_1 r_2 = bc$. This result is therefore obvious as the immediate interpretation of the w - z equation without reference to the polar form.

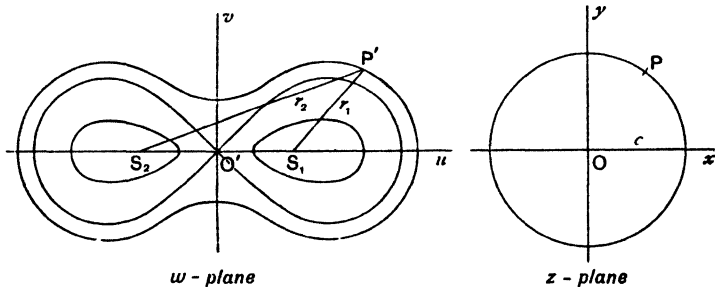

Fig. 359.

Since in the z -curve the loci $r = \text{const.} = c$, $\theta = \text{const.} = 2a$, form a pair of loci cutting orthogonally, the corresponding curves on the w -plane cut orthogonally.

The curves corresponding to $r = \text{const.}$ have been seen to be Cassinians.

The curves corresponding to $\theta = 2a$ are rectangular hyperbolae.

For since $r^2 e^{2i\theta} - a^2 = bre^{2ia} = bre^{2ia}$,

$$r'^2 \cos 2\theta' - a^2 = br \cos 2a, \quad r'^2 \sin 2\theta' = br \sin 2a,$$

that is,

$$r'^2 \sin 2(\theta' - a) + a^2 \sin 2a = 0.$$

These hyperbolae for a parameter a are therefore the orthogonal trajectories of the Cassinians $r_1 r_2 = \text{const.}$

Further, it may be remarked that in considering the transformation $w^2 - a^2 = bz$, we have really considered any transformation of the form

$Aw^2 + Bw + C = z$; for by putting $w = w' - \frac{B}{2A}$, we have

$$Aw'^2 - \frac{B^2}{4A} + C = z,$$

which is of the form $w^2 - a^2 = bz$.

Hence the results for $Aw^2 + Bw + C = z$ are the same as those considered, with a mere transformation of the position of the axes.

1253. Curvature ; the Form for Cartesians.

We may put the curvature formula of Art. 1251 into another form more particularly useful for a Cartesian z -locus.

For $w = f(z) = f(x + iy), \quad dw = f'(z) dz,$

$$|dz| = \sqrt{dx^2 + dy^2}, \quad |dw| = |f'(z)| \cdot |dz|;$$

whence
$$\frac{|f'(z)|}{\rho'} - \frac{1}{\rho} = \frac{\frac{d}{dx} \text{amp. } f'(z)}{\sqrt{1 + \left(\frac{dy}{dx}\right)^2}}. \dots\dots\dots(B)$$

1254. Thus, if the z -locus is a straight line for instance, say $y = mx + c,$

$$\rho = \infty, \quad \frac{dy}{dx} = m \quad \text{and} \quad \rho' = \frac{|f'(z)|\sqrt{1+m^2}}{\frac{d}{dx} \text{amp. } f'(z)}.$$

1255. Illustrative Examples.

(1) For example, in the case $w = a \cos z$ considered in Art. 1236, for which $X = a \cos x \cosh y, \quad Y = -a \sin x \sinh y,$ so that $y = c$ gives the ellipse

$$\frac{X^2}{a^2 \cosh^2 c} + \frac{Y^2}{a^2 \sinh^2 c} = 1, \text{ we have}$$

$$f(z) = a \cos z,$$

$$f'(z) = -a \sin z = -a(\sin x \cosh y + i \cos x \sinh y),$$

$$|f'(z)| = a\sqrt{\sin^2 x \cosh^2 y + \cos^2 x \sinh^2 y} = a\sqrt{\cosh 2y - \cos 2x}/\sqrt{2},$$

$$\text{amp. } f'(z) = \tan^{-1}(\cot x \tanh y),$$

$$\frac{d}{dx} \text{amp. } f'(z) = \frac{\sin 2x \frac{dy}{dx} - \sinh 2y}{\cosh 2y - \cos 2x};$$

and in our case for $y = c,$ we have $\rho = \infty, \quad \frac{dy}{dx} = 0, \quad m = 0,$ and the radius of curvature of the derived curve is

$$\frac{a}{\sqrt{2}} \frac{(\cosh 2c - \cos 2x)^{\frac{3}{2}}}{\sinh 2c}, \quad \text{where } \cos x = \frac{X}{a \cosh c},$$

which may be readily verified directly for the ellipse.

(2) (A) In the case $w = \frac{z^n}{a^{n-1}}$ (a real), we have

$$r'e^{i\theta} = \frac{r^n e^{in\theta}}{a^{n-1}}, \quad r' = \frac{r^n}{a^{n-1}}, \quad \theta' = n\theta.$$

Hence to any z -locus $F(r, \theta) = 0$ corresponds a w -locus

$$F\left(a^{\frac{n-1}{n}} r^{\frac{1}{n}}, \frac{\theta'}{n}\right) = 0.$$

In this case, since $\theta' = n\theta$, a z -line through the origin corresponds to a w -line through the origin, and in consequence in this case $\phi = \phi'$, i.e. the angles which the tangents make with their radii vectores are equal.

Hence to an equiangular spiral in the z -plane and with pole at the origin corresponds another and equal equiangular spiral in the w -plane with its pole at the new origin.

(B) Moreover, since $\psi - \theta = \psi' - \theta'$, we have $\psi' - \psi = \theta' - \theta$, whence

$$\frac{|dw|}{\rho'} - \frac{|dz|}{\rho} = d \text{ amp. } w - d \text{ amp. } z,$$

which is what the curvature formula of Art. 1251 reduces to, since

$$f'(z) = \frac{n r^{n-1}}{a^{n-1}} e^{i(n-1)\theta} \text{ and } \text{amp. } f'(z) = (n-1)\theta = \text{amp. } w - \text{amp. } z.$$

(C) In this group of results, if we take the z -locus as the straight line $r \cos \theta = a$, we have

$$\phi' = \phi = \frac{\pi}{2} - \theta = \frac{\pi}{2} - \frac{\theta'}{n},$$

which gives the well-known property of all curves of the form

$$r^{-\frac{1}{n}} = a^{-\frac{1}{n}} \cos\left(-\frac{1}{n}\theta\right),$$

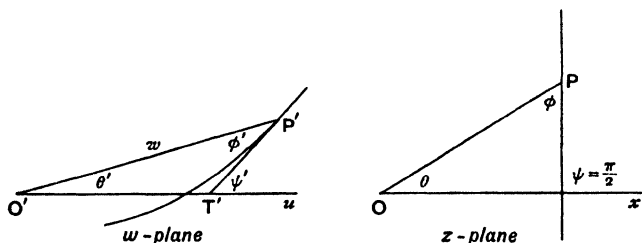

Fig. 360.

which include as particular cases the Parabola ($n=2$), the Rectangular Hyperbola ($n=\frac{1}{2}$), Bernoulli's Lemniscate ($n=-\frac{1}{2}$), the Cardioide ($n=-2$), the Straight Line ($n=1$) and the Circle ($n=-1$).

(D) To any curve $r^p = a^p \cos p\theta$ corresponds the curve

$$(r'a^{n-1})^{\frac{p}{n}} = a^p \cos \frac{p\theta'}{n}, \text{ i.e. } r^q = a^q \cos q\theta, \text{ where } \frac{p}{q} = n.$$

Hence to $r^{\frac{n-1}{k}} = a^{\frac{n-1}{k}} \cos \frac{n-1}{k}\theta$ corresponds its own k^{th} pedal curve, for the k^{th} pedal is got by substituting for the present index and multiple of θ

$$\frac{\frac{n-1}{k}}{1+k\frac{n-1}{k}} \text{ for } \frac{n-1}{k}, \text{ i.e. } \frac{n-1}{kn} \text{ for } \frac{n-1}{k},$$

which gives the ratio $n : 1$ for the indices and multiple of θ as required.

(E) **Quasi-Inversion.**

The conformal representation of $w = \frac{k^2}{z}$, where k is real, is very important.

We have at once $r'e^{i\theta'} = \frac{k^2}{re^{i\theta}} = \frac{k^2}{r} e^{-i\theta}$; whence $r'r = k^2$ and $\theta' = -\theta$.

Hence, if the same axes be taken for the z and w curves, we have a combination of inversion and reflexion in the x -axis. This process is known as Quasi-Inversion. The name is due to Cayley.

Now, reflexion with regard to a straight line makes no difference in the nature of a curve. Hence the usual rules of inversion apply, viz. a straight line which does not pass through the origin inverts into a circle through the origin. If the straight line pass through the origin it inverts into a straight line through the origin. To a circle through the origin corresponds a straight line not through the origin. To a circle which does not pass through the origin corresponds another circle which does not pass through the origin. To a parabola with focus at the origin corresponds a Cardioid with pole at the origin. To a conic with focus at the origin corresponds a Limaçon with pole at the origin, and so on.

Hence when the z -curve is given, the w -curve is at once known and can be constructed by the reflexion of the curve traced by a Peaucellier cell linkage arrangement as explained in *Diff. Calc.*, Art. 232.

(F) **The Homographic Relation.**

Consider next the conformal representation of $w = \frac{az + b}{cz + d}$.

This is the general linear transformation. It is known as a "Homographic" relation between w and z .

Obviously $cwz + dw - az - b = 0$,

or
$$\left(w - \frac{a}{c}\right)\left(z + \frac{d}{c}\right) = \frac{b}{c} - \frac{ad}{c^2} = \frac{bc - ad}{c^2}.$$

Now this transformation is unaltered by changes in a, b, c, d , which preserve the ratios. In fact, there are only three constants, namely the ratios $a : b : c : d$. There is therefore no loss of generality in taking $bc - ad = 1$.

This being done, let $w = \frac{a}{c} + w'$, $z = -\frac{d}{c} + z'$, which merely shifts the origins of w and z , retaining axes parallel to their original directions; for if $\frac{a}{c} = \alpha + i\beta$, say, and $-\frac{d}{c} = \gamma + i\delta$, the new origins will be the points (α, β) and (γ, δ) respectively; we then have $w'z' = \frac{1}{c^2}$, i.e. another quasi-inversion connection between the z and w loci.

(G) Obviously, if when $w = \frac{az + b}{cz + d}$, z is itself connected with a third variable t by another homographic relation $z = \frac{pt + q}{rt + s}$, then upon substituting for z , w is of the form $\frac{At + B}{Ct + D}$, whether the variables and constants involved be real or complex.

That is, if w be homographic with regard to z and z be homographic with regard to t , then w is homographic with regard to t , and so on for any number of variables.

The relation may obviously be thrown into the form

$$\frac{\lambda}{wz} + \frac{\mu}{w} + \frac{\nu}{z} + 1 = 0,$$

where λ, μ, ν are constants. This relation is of much use in the theory of geometrical optics, in various forms, the quantity λ being there usually zero.

The equation $w = \frac{az+b}{cz+d}$ may be written further in the form

$$\frac{w-\lambda}{w+\lambda} = \frac{(a-\lambda c)z+(b-\lambda d)}{(a+\lambda c)z+(b+\lambda d)} = k \frac{z-\mu}{z+\mu}, \text{ say ;}$$

so

$$\left| \frac{w-\lambda}{w+\lambda} \right| = |k| \left| \frac{z-\mu}{z+\mu} \right|.$$

And if we use bi-focal coordinates in each system, viz. (R, R') and (r, r') , the two foci on the two planes being $\lambda, -\lambda$ in the w -plane and $\mu, -\mu$ in the z -plane, then $\frac{R}{R'} = |k| \frac{r}{r'}$, so that when z describes a circle in the z -plane, viz. $r:r' = \text{constant}$, w will describe a circle in the w -plane, viz. $R:R' = \text{constant}$, a result which has been already stated.

The case $\frac{w-a}{w-b} = z$ is a case of the above quasi-inversion.

We have $\left| \frac{w-a}{w-b} \right| = |z|$, and if the z -locus is the fixed circle $|z| = \text{constant}$, the w -locus is a fixed circle.

(H) Consider next the conformal representation of the equation

$$w = Az^a + Bz^\beta + Cz^\gamma + \dots,$$

where A, B, C, \dots and a, β, γ, \dots are all real positive quantities.

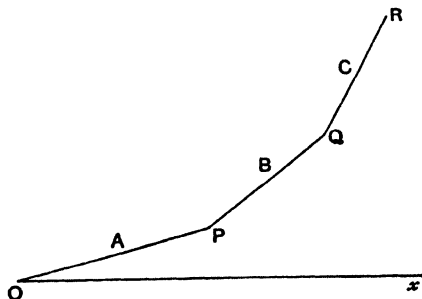

Fig. 361.

Putting, as in previous cases, $z = re^{i\theta}$, $w = r'e^{i\theta'} = X + iY$,

$$X = A_1 r^a \cos a\theta + B_1 r^\beta \cos \beta\theta + C_1 r^\gamma \cos \gamma\theta + \dots$$

$$Y = A_1 r^a \sin a\theta + B_1 r^\beta \sin \beta\theta + C_1 r^\gamma \sin \gamma\theta + \dots$$

If we take the z -curve to be a circle of radius unity, then for the w -curve $X = \Sigma A \cos \alpha\theta$, $Y = \Sigma A \sin \alpha\theta$, and this locus can be constructed as the locus of a point carried on one of a set of hinged rods OP, PQ, QR, \dots of lengths A, B, C, \dots , the carried point being considered as the end of the last rod and one end of the first rod fixed at a point O , the whole system moving in a plane and the several rods rotating with angular velocities in the ratio $\alpha : \beta : \gamma : \dots$; in fact, what is usually known as an epicyclic train of linkages.

(1) Consider the case of two terms $w = Az^a + Bz^b$.

Let Q be a point attached to a circle of centre P and radius b , which rolls without sliding upon the outside of the circumference of a fixed

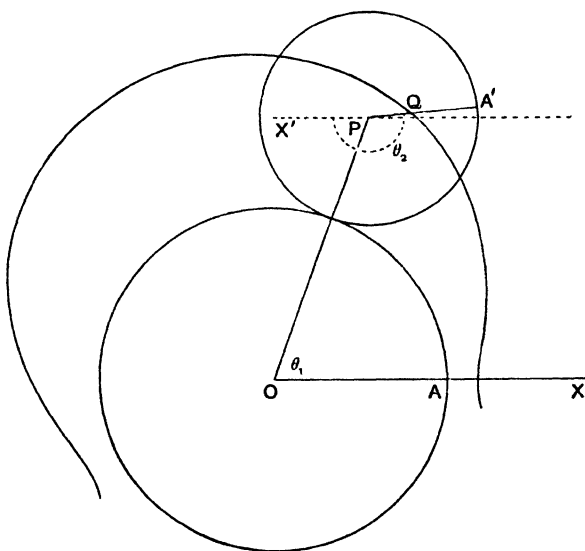

Fig. 362.

circle of centre O and radius a , and let $PQ = \rho$, and θ_1, θ_2 , the angles which OP and PQ have turned through since A' , the extremity of the radius which passes through Q of the moving circle, was in contact with the fixed circle at A . Let PX' be parallel to AO . Then the angle $X'PA'$ (marked in the figure as $> \pi$) is θ_2 .

Then, for pure rolling,

$$a\theta_1 = b(\theta_2 - \theta_1) \quad \text{or} \quad (a+b)\theta_1 = b\theta_2.$$

Let $\theta_1 = \alpha\theta$, $\theta_2 = \beta\theta$, and take $A = a+b$, $B = -\rho$.

$$\therefore \frac{a+b}{\beta} = \frac{b}{\alpha} = \frac{A}{\beta}, \quad \text{i.e. } b = \frac{\alpha}{\beta}A \quad \text{and} \quad a = \frac{\beta-a}{\beta}A.$$

Then the coordinates of Q are

$$X = A \cos \alpha\theta + B \cos \beta\theta, \quad Y = A \sin \alpha\theta + B \sin \beta\theta.$$

So $w = Az^\alpha + Bz^\beta$ gives in this case a trochoidal locus for w corresponding to the circular locus for z , the trochoid being traced by the motion of a point at distance $\rho (= -B)$ from the centre of a circle of radius $b \left(= \frac{a}{\beta} A \right)$ rolling upon a fixed circle of radius $a \left(= \frac{\beta - a}{\beta} A \right)$. If $\rho = b$, an epicycloid is traced by the w -point, supposing b to be positive.

In the case $a = b = \rho$ we have

$$A = 2a, \quad B = -a, \quad \text{and} \quad \frac{a}{\beta} = \frac{b}{A} = \frac{a}{2a} = \frac{1}{2}, \quad \text{i.e.} \quad \beta = 2a,$$

so that the w - z relation is $w = 2az^\alpha - az^{2\alpha}$.

And in this case the epitrochoidal curve is a cardioid.

It is unnecessary to particularise the value of a which is the ratio of the rates of angular description of the circle traced by P and the unit circle traced by the z -point. If we take $a = 1$ for simplicity, then $\beta = 2$, and we have

$$w = 2az - az^2.$$

The correspondence of the z -curve and the w -curve is shown in the adjoining figure, where corresponding points on the two loci are indicated by the same letter, unaccented for the z -curve, accented for the w -curve.

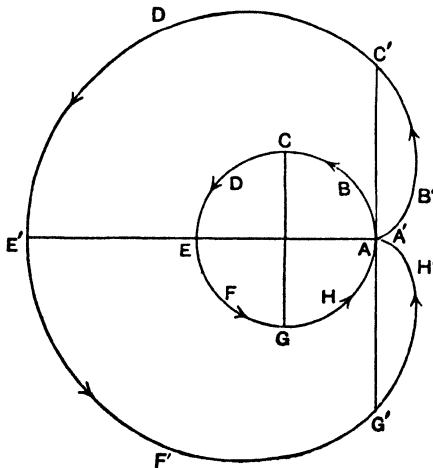

Fig. 363.

In the figure the w -plane is supposed, for convenience, to be superposed upon the z -plane.

(J) If b be negative and $\rho = b = -b'$, we have a hypocycloid traced, and

$$A = a - b', \quad B = b', \quad \frac{\beta - a}{\beta} = \frac{a}{a - b'}, \quad \text{i.e. } \beta = \frac{b' - a}{b'} a,$$

giving
$$w = (a - b')z^a + b'z^{-\frac{a-b'}{b'}}.$$

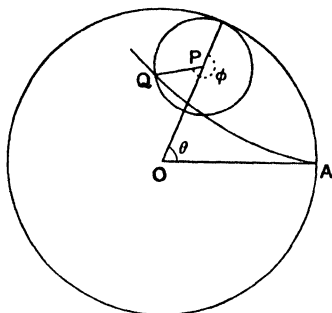

Fig. 364.

And the particular case in which $b' = \frac{a}{2}$ gives $w = \frac{a}{2}(z^a + z^{-a})$.

And $|z| = 1$ by hypothesis, so $z = e^{i\theta}$.

Hence $w = a \cos a\theta$, which is then a real quantity.

And as $w = u + iv$, we have $u = a \cos a\theta, v = 0$, i.e. the diameter of the fixed circle is traced by the w -point, as is well known.

(K) For a three-cusped hypocycloid,

$$\rho = b = -\frac{a}{3}, \quad A = \frac{2a}{3}, \quad B = \frac{a}{3}, \quad \frac{a}{\beta} = \frac{b}{A} = -\frac{1}{2}; \quad \therefore \beta = -2a.$$

And the w - z relation is $w = \frac{2}{3}az^a + \frac{1}{3}az^{-2a}$, and so on for other cases.

It should be noted also that the order of the terms Az^a, Bz^b is immaterial; that is, we might regard w as given by $w = Bz^b + Az^a$.

And then the same epicycloid or hypocycloid, or epitrochoid or hypotrochoid, as the case may be, can be traced in another way, viz. by the rolling of a circle of radius $\frac{\beta}{a}B$ upon a fixed circle of radius $\frac{a - \beta}{a}B$.

(L) The case $\frac{w}{a'} = \log \frac{z}{a}$, where a, a' are real constants.

This case gives
$$\frac{r'}{a'} e^{i\theta'} = \log \left(\frac{r}{a} e^{i\theta} \right) = \log \frac{r}{a} + i(\theta + 2\lambda\pi);$$

whence
$$\log \frac{r'}{a'} = \frac{r'}{a'}, \quad \cos \theta' = \frac{x'}{a'}, \quad \theta + 2\lambda\pi = \frac{r'}{a'}, \quad \sin \theta' = \frac{y'}{a'}.$$

So that to a circle $r = \text{const.}$ on the z -plane corresponds a straight line parallel to the y -axis on the w -plane; and to a straight line through the origin, $\theta = \text{const.}$, on the z -plane corresponds a family of straight lines parallel to the x -axis on the w -plane.

Corresponding to the Archimedean Spiral $r = a\theta$ on the z -plane, we have, on the w -plane, a family of logarithmic curves, viz.

$$\frac{y'}{a'} - 2\lambda\pi = \frac{x'}{a} e^{x'}$$

Corresponding to the Equiangular Spiral $r = ae^{\theta \cot \beta}$ on the z -plane, we have, on the w -plane, the family

$$ae^{\frac{x'}{a}} = ae^{\left(\frac{y'}{a'} - 2\lambda\pi\right) \cot \beta}, \quad \text{i.e. } \frac{y'}{a'} - 2\lambda\pi = \tan \beta \left(\frac{x'}{a} + \log \frac{a}{a}\right),$$

viz. a family of parallel straight lines.

As a further example of the use of the curvature formula of Art. 1251, viz.

$$\frac{|f'(z) dz|}{\rho'} - \frac{|dz|}{\rho} = d \text{ amp. } f'(z),$$

let us apply it in the last case.

We have $f'(z) dz = a' \frac{dz}{z}$ and $\text{amp. } f'(z) = -\theta$;

$$\therefore \frac{a' \left| \frac{dz}{z} \right|}{\rho'} - \frac{|dz|}{\rho} = -d\theta.$$

In the particular case where the z -curve is the equiangular spiral,

$$z = ae^{\theta(\cot \beta + i)}, \quad \frac{dz}{z} = (\cot \beta + i) d\theta, \quad dz = re^{\theta}(\cot \beta + i) d\theta \\ = \frac{r}{\sin \beta} e^{i(\theta + \beta)} d\theta;$$

and $\left| \frac{dz}{z} \right| = \frac{d\theta}{\sin \beta}$, $|dz| = \frac{r}{\sin \beta} d\theta$ and $\rho' = \infty$.

Thus the formula reduces to $\rho = r \operatorname{cosec} \beta$, which is the well-known result for an equiangular spiral.

1256. Branches and Branch Points.

In the case of a multiple-valued function, where each value of the independent variable z leads to more than one value of the dependent variable w , the several values of w are said to be branches of the function. Thus, if the equation connecting w and z be $F(w, z) = 0$, and if one solution for w we find

$$w_1 = f_1(z), \quad w_2 = f_2(z), \quad w_3 = f_3(z), \text{ etc.,}$$

each of these forms being now single-valued, then w_1, w_2, w_3 , etc., are called the "branches" of w .

When z traces any curve in the (x, y) plane, each of the functions w_1, w_2, w_3, \dots traces out a corresponding curve in the (u, v) plane, and each curve is a graph of its own branch.

If for any point z two values of w become equal, such point is said to be a "branch point" of w . A line which

connects two and only two branch points is called a branch line or cross line.

1257. The simplest example is the case when $w^2=z$. Here w is a two-valued function. The function has "branches" $w_1 = +\sqrt{z}$, $w_2 = -\sqrt{z}$.

At the points $z=0$ and $z=\infty$ there are "branch points." The positive direction of the x -axis which joins $z=0$ to $z=\infty$ is a branch line.

1258. To examine the behaviour of w_1 and w_2 in the immediate neighbourhood of the branch point at $z=0$, put $z=re^{i\theta}$, and travel round the point along a small circle of radius r ; r remains constant, θ increases by 2π .

$$w_1 = +\sqrt{re^{i\theta}} \text{ becomes } \sqrt{re^{i(\theta+2\pi)}} = e^{i\pi}\sqrt{re^{i\theta}} = -\sqrt{re^{i\theta}} = w_2,$$

$$w_2 = -\sqrt{re^{i\theta}} \text{ becomes } -\sqrt{re^{i(\theta+2\pi)}} = -e^{i\pi}\sqrt{re^{i\theta}} = \sqrt{re^{i\theta}} = w_1.$$

Hence in passing once round the branch point $z=0$, and therefore crossing the branch line, each branch changes into the other.

1259. Similarly for the case $w^q=z$, where q is a positive integer.

Here w is a q -valued function of z , and we have

$$w = z^{\frac{1}{q}} \left(\cos \frac{2\lambda\pi}{q} + i \sin \frac{2\lambda\pi}{q} \right), \text{ where } \lambda = 1, 2, 3, \dots \text{ or } q.$$

Let the q q^{th} roots of unity be called $a, a^2, a^3, \dots a^q$.

Then the branches of the function may be written

$$w_1 = az^{\frac{1}{q}}, \quad w_2 = a^2 z^{\frac{1}{q}}, \quad w_3 = a^3 z^{\frac{1}{q}}, \dots w_q = a^q z^{\frac{1}{q}},$$

where by $z^{\frac{1}{q}}$ we mean any definite q^{th} root of z , the same to be taken throughout.

The points $z=0$ and $z=\infty$ are branch points, and the positive portion of the x -axis is a branch line.

In passing once round a small circle of radius r encircling a branch point, say that at $z=0$, w_s changes from being

$$a^s (re^{i\theta})^{\frac{1}{q}} \text{ to being } a^s [re^{i(\theta+2\pi)}]^{\frac{1}{q}}, \text{ that is to}$$

$$a^s e^{i\frac{2\pi}{q}} (re^{i\theta})^{\frac{1}{q}} \text{ or } a^{s+1} (re^{i\theta})^{\frac{1}{q}};$$

therefore w_s changes to w_{s+1} .

Thus the system of branches changes from

$w_1, w_2, w_3, \dots w_{q-1}, w_q$ to $w_2, w_3, w_4, \dots w_q, w_1$, and a second encircling of this small contour will cause the further change to $w_3, w_4, w_5, \dots w_1, w_2$, and so on. So that when z has travelled q times round the branch point at $z=0$, the original order will have been restored.

Similarly also for the case $w^q = z^p$, where p and q are positive integers prime to each other,

1260. Reverting to the case $w^2 = az$, where a is positive and real, put

$$z = re^{i\theta}, \quad w_1 = r_1 e^{i\theta_1}, \quad w_2 = r_2 e^{i\theta_2}.$$

Then $w_1 \equiv r_1 e^{i\theta_1} = +\sqrt{are^{i\theta}}, \quad w_2 \equiv r_2 e^{i\theta_2} = -\sqrt{are^{i\theta}} = \sqrt{are^{i(\theta+2\pi)}};$

$$r_1 = \sqrt{ar}, \quad \theta_1 = \frac{\theta}{2}; \quad r_2 = \sqrt{ar}, \quad \theta_2 = \pi + \frac{\theta}{2}.$$

We show separate w -planes for the separate branches. (Fig. 365.)

Take as the z -curve the circle $r = a$.

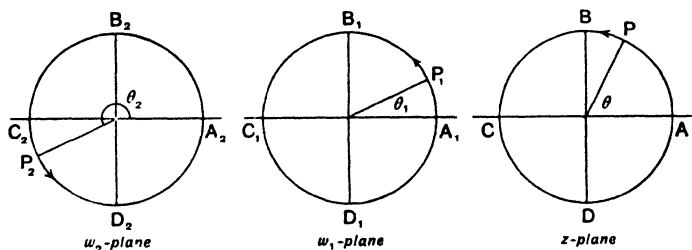

Fig. 365.

Here, as $P(z)$, moves round the circumference $ABCD$ of the circle $r = a$, the points $P_1(w_1)$, and $P_2(w_2)$, respectively describe two semi-circles shown in the accompanying figure, viz. the upper half circle $A_1B_1C_1$ for w_1 and the lower half circle $C_2D_2A_2$ for w_2 . When P traverses its path a second time, P_1 proceeds to describe the lower half circle of w_1 , viz. $C_1D_1A_1$, whilst P_2 describes the upper half $A_2B_2C_2$ for w_2 .

1261. Sheets, Riemann's Surface.

In order to avoid the inconvenience of the same value of z indicating two or more values of w , the following device is adopted.

Imagine the x - y plane upon which the point z travels to be split into as many parallel sheets as there are values of w to which any one value of z gives rise. Let these sheets still carry with them the tracings of the original axes, and let them be separated from each other by infinitesimal distances ϵ , the

origins lying in a line perpendicular to the several planes and the axes remaining parallel, and let the same point z be marked upon each plane. Let the several planes be designated as No. 1, No. 2, No. 3, etc., and be associated with the several functions $w=w_1$, $w=w_2$, $w=w_3$, etc., to which the value of z gives rise, so that when z travels on plane No. 1, the graph of w_1 is traced on the w -plane, when z travels on plane No. 2 the graph of w_2 is traced on the w -plane, and so on. In this way each value of z with its particularising plane gives rise only to one value of w , so that w may now be looked upon as a single-valued function of z , and z requires for its description not only the values of x and y , but also the number or label of its particularising plane.

Now it will be inferred from the examples considered that when z in its travel upon the original x - y plane in continuous motion crosses a branch line AB in that plane there is a change in the branch of the function, w_1 to w_2 say. In order to represent the continuous motion of z in our new system of sheets from plane (1) to plane (2) it will be necessary to suppose the existence of a plane bridge extending from A to B , and terminating at these points and leading from plane (1) on which A, B lie to plane (2) on which A', B' lie where A', B' are the new positions of A, B on plane (2), so that in passing from z_1 on plane (1) to z_2 on plane (2) the point z passes down the bridge of infinitesimal length from the one plane to the other without changing its value in so passing.

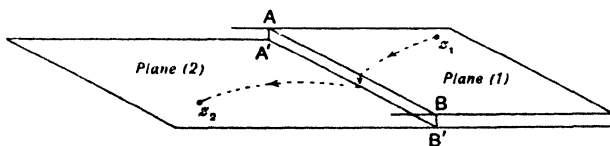

Fig. 366.

And in the case when there are only two branch points and one branch line, we shall consider the several z -sheets to be nowhere else connected. Thus, as z passes over this bridge from plane (1) to plane (2), w_1 changes to w_2 . After travelling in plane (2) the point z must again cross the bridge to get back to its original position z_1 , for there is no other connection

between the planes (2) and (1). The excursion of z from plane (1) to plane (2) and back again may be indicated to an eye looking endwise along the branch line from B to A , as in the diagram No. 367, the bridge being represented in duplicate as PQ or $P'Q'$ for convenience.

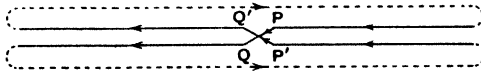

Fig. 367.

Thus, in the case of $w^2=z$, we have the diagram of the change indicated in Fig. 368.

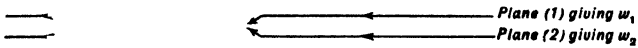

Fig. 368.

In the case of $w^q=z$ the cyclic order of changes as z passes the branch line is indicated in Fig. 369 (taking, for example, $q=5$).

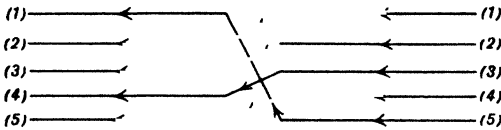

Fig. 369.

The whole system of sheets thus connected by means of a bridge through the branch line is then regarded as forming a continuous surface, and is known as a Riemann's Surface.

1262. Enough has been said to indicate one method of representation by means of which the consideration of a multiple-valued function z may be regarded as reduced to the consideration of a single-valued function. And this will suffice for our purposes in this book. The whole theory of Branch points, Branch lines and Riemann's representation would occupy far more space than is at our disposal, and we must refer the student to treatises on the Theory of Functions, e.g. Forsyth, *Theory of Functions*, Chapter XV., or Harkness and Morley, *Theory of Functions*, Chapter VI., where this very interesting matter will be found fully discussed.

1263. Any Algebraic Equation of the n^{th} degree has n roots, n being a positive integer.

Let $w \equiv F(z) = z^n + p_1 z^{n-1} + p_2 z^{n-2} + \dots + p_n = 0$, where z and the several coefficients may be real or complex and n is a positive integer.

Whilst z travels over the whole of the z -plane it is obvious that w will travel over at any rate some part of the w -plane.

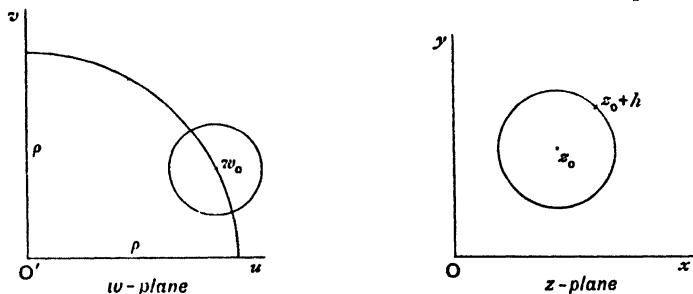

Fig. 370.

Let O and O' be the two origins. Then we shall show that w must reach O' in its travels over the w -plane. For, if there were any finite limit of the nearness of approach of w to O' , let ρ be that limit. Let z_0 be the value of z for which w arrives at its limiting value, w_0 say, which must lie somewhere on the circumference of a circle of radius ρ in the w -plane and having O' for its centre.

Consider the vector $z = z_0 + h$.

Then $w = (z_0 + h)^n + p_1(z_0 + h)^{n-1} + p_2(z_0 + h)^{n-2} + \dots + p_n$, which, by multiplying out the several terms and arranging in powers of h , we may write as

$$w = F(z_0) + hF'(z_0) + \frac{h^2}{2!}F''(z_0) + \dots + \frac{h^n}{n!}F^{(n)}(z_0),$$

where $F(z_0)$, $F'(z_0)$, etc., are the several coefficients occurring, and are functions of z_0 alone, finite so long as z_0 is finite. Then obviously $w_0 = F(z_0)$, and therefore

$$w - w_0 = hF'(z_0) + \frac{h^2}{2!}F''(z_0) + \dots + \frac{h^n}{n!}F^{(n)}(z_0) = hF'(z_0) + \xi, \text{ say.}$$

Then, provided $F'(z_0)$ does not vanish, we can, by making h sufficiently small, make the ratio $\xi : hF'(z_0)$ less than any assignable quantity.

And even if $F'(z_0)$ does vanish, as well as

$$F''(z_0), F'''(z_0) \dots F^{(r-1)}(z_0), \text{ say,}$$

so that $\frac{h^r}{r!}F^{(r)}(z_0)$ is the first term which does not vanish, we can in the same way, by taking h sufficiently small, make the remainder of the series beyond the term $\frac{h^r}{r!}F^{(r)}(z_0)$ bear to this term a ratio less than any assignable quantity, and therefore ultimately, when h is indefinitely small,

$$w - w_0 = \frac{hF'(z_0)}{1!} \quad \text{or} \quad \frac{h^r}{r!}F^{(r)}(z_0),$$

as the case may be.

Now let the point $z_0 + h$ travel in a small circle round z_0 as its centre. In doing this the amplitude of h is increased by 2π and that of h^r by $2r\pi$, r being a positive integer, whilst that of $F'(z_0)$ or $F^{(r)}(z_0)$ is unaltered.

Therefore the amplitude of $w - w_0$ increases by 2π or by $2r\pi$, and the point w describes some curve about w_0 which returns into itself after one or r complete circuits, as z describes a small circle about z_0 . Hence it must penetrate at least once into the circle of radius ρ in its travel about w_0 . And this contradicts the hypothesis that there is an inferior limit to the closeness of approach of w to O'

There must therefore be at least one value of z , say $z = z_1$, for which w coincides with the origin O' and makes $F(z)$ vanish.

Hence $z - z_1$ must be a factor of $F(z)$.

Dividing out $z - z_1$ from $F(z)$ we get an expression of degree $n - 1$ in powers of z to which the same process can be applied.

And, proceeding in this way, it is clear that $F(z)$ must have n zeros.

And, if $z_1, z_2, z_3, \dots, z_n$ be the values of z for which $F(z)$ vanishes, we get $w = A(z - z_1)(z - z_2)(z - z_3) \dots (z - z_n)$, where A is independent of z , but may be a complex constant.

$$\text{Thus} \quad \text{mod. } w = \text{mod. } A \cdot \prod_{r=1}^{r=n} \text{mod. } (z - z_r),$$

$$\text{and} \quad \text{amp. } w = \text{amp. } A + \sum_{r=1}^{r=n} \text{amp. } (z - z_r).$$

1264. Number of roots within a given Contour.

We are now in a position to assign the number of roots of $w=0$ which lie within a given contour in the w -plane.

When z travels in a closed curve once round z_0 the amplitude of the vector $z-z_0$ is increased by 2π , and if the closed curve encircles z_0 r times before returning to the starting point, the amplitude of the vector is increased by $2r\pi$.

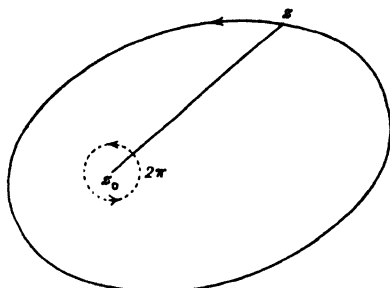

Fig. 371.

When z travels round a closed contour which does not enclose z_0 the amplitude of $z-z_0$ increases by a certain amount, and then decreases again till it assumes its original value when the whole circuit of the contour has been traversed, so that there is no change in the amplitude.

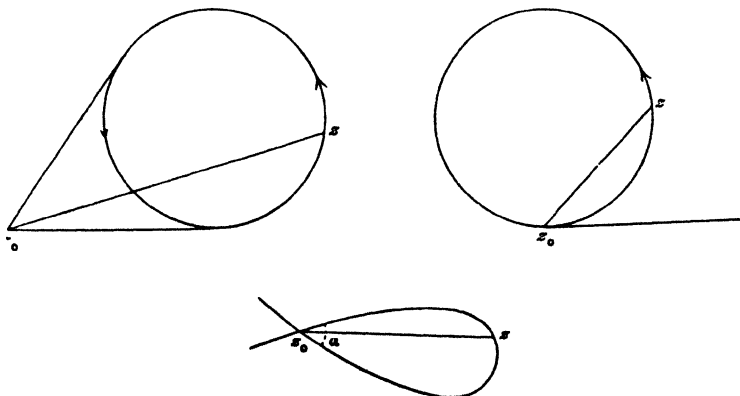

Fig. 372.

If the z -contour passes through z_0 at a point of continuous curvature of the contour instead of surrounding it, there is a change of π in the amplitude

of $z - z_0$. If z_0 be situated at a node of the z -curve, then, when z describes a loop starting from the node by one of the branches which passes through z_0 and returning to the node by another branch, the change in the amplitude of $z - z_0$ is α , where α is the angle between the directions of the two tangents at the node between which the loop lies.

Remembering that if

$$w = A(z - z_1)(z - z_2)(z - z_3) \dots (z - z_n)$$

we have $\text{amp. } w = \text{amp. } A + \text{amp. } (z - z_1) + \dots + \text{amp. } (z - z_n)$,

it obviously follows that if z is made to travel round any contour which encloses any r of the n zeros of w , viz. $z_1, z_2, z_3, \dots, z_n$, and no more, and does not pass through any of them, and if the contour be such as to encircle them each once only, the change of the amplitude in w will be $2r\pi$. If, however, it passes *through* one of the other zeros at a point of continuous curvature of the contour besides encircling the r zeros considered before, there will be a change of amplitude to the extent of $(2r+1)\pi$. Conversely, if as z passes along the perimeter of any region S it be observed that the change of amplitude is $2r\pi$, we infer either that there are r zeros of w within that region or $r-2p$ zeros within and $2p$ upon the boundary, and that, if the change of amplitude be $(2r+1)\pi$, there will be r zeros within and one upon the boundary or $r-2p$ zeros within and $2p+1$ upon the boundary, so that in the one case there are r roots within or upon the boundary, and in the other there are $r+1$ roots within or upon the boundary, and the number upon the boundary is even in the first case, odd in the second, and if the change of amplitude be an odd multiple of π there must be at least one zero of w on the boundary of the contour.

1265. Illustrative Examples.

1. Consider the equation

$$w \equiv z^4 - 2z^3 - z^2 + 2z + 10 = 0.$$

Take a contour bounded by a circular arc, centre at the origin, and of infinite radius R and the positive directions of the x and y -axes, viz. the quadrant OAB .

Then (1) as z travels along the x -axis, $y=0$ and the amplitude of z , and therefore also of w is zero, in moving from O to A .

(2) As z travels along the quadrantal arc AB of the infinite circle,

$$w = R^4 \left(e^{4i\theta} - 2 \frac{e^{3i\theta}}{R} - \frac{e^{2i\theta}}{R^2} + 2 \frac{e^{i\theta}}{R^3} + \frac{10}{R^4} \right) = R^4 e^{4i\theta} \text{ ultimately,}$$

and as θ changes from 0 to $\frac{\pi}{2}$ the increase of amplitude is $4 \cdot \frac{\pi}{2} = 2\pi$.

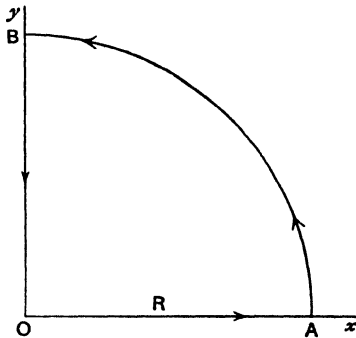

Fig. 373.

(3) As z travels from $z = \infty$ at B down the y -axis to O , $x=0$, and $z = iy = ir$, say, and $w = r^4 + 2ir^3 + r^2 + 2ir + 10 = \rho(\cos \phi + i \sin \phi)$, say, where

$$\tan \phi = 2 \frac{r^3 + r}{r^4 + r^2 + 10}, \dots\dots\dots(a)$$

so that $\tan \phi$ remains positive as r decreases from ∞ to zero, vanishing at both limits. To find where it attains its maximum value, we have by differentiation

$$\frac{1}{2} \sec^2 \phi \frac{d\phi}{dr} = - \frac{r^6 + 2r^4 - 29r^2 - 10}{(r^4 + r^2 + 10)^2}, \dots\dots\dots(b)$$

and the equation to find the stationary values of $\tan \phi$ is

$$r^6 + 2r^4 - 29r^2 - 10 = 0, \dots\dots\dots(c)$$

which being a cubic for r^2 must have one value of r^2 real. Moreover, as $r^2 = \infty$ makes the left-hand member positive, and $r^2 = 0$ makes it negative, a real value of r^2 must lie between 0 and infinity; and further, Descartes' rule of signs shows that there cannot be more than one real positive root. Let that root be $r^2 = \alpha^2$, and let the remaining roots, both real or both imaginary, be β^2 and γ^2 .

$$\text{Then } \frac{1}{2} \sec^2 \phi \frac{d\phi}{dr} = - \frac{(r^2 - \alpha^2)(r^2 - \beta^2)(r^2 - \gamma^2)}{(r^4 + r^2 + 10)^2}.$$

If both β^2 and γ^2 be real negative quantities, $r^2 - \beta^2$ and $r^2 - \gamma^2$ are both positive.

If β^2 and γ^2 be unreal, the product $(r^2 - \beta^2)(r^2 - \gamma^2)$ cannot change sign as r changes through real values from ∞ to zero, and this product is ultimately r^4 when r is infinite. Hence in either case $(r^2 - \beta^2)(r^2 - \gamma^2)$ is positive.

Also r is *decreasing*. Hence

from $r=R$ to $r=a$, we have $\frac{d\phi}{dr} = (-)^n$, therefore $\tan \phi$ is increasing,
and from $r=a$ to $r=0$, $\frac{d\phi}{dr} = (+)^n$, therefore $\tan \phi$ is decreasing.

But at $r=R$ the amplitude ϕ is 2π .

Hence ϕ increases to some value between 2π and $2\pi + \frac{\pi}{2}$, and then returns to its value 2π .

There is therefore only one root of the equation in the first quadrant.

If we take the first two quadrants as our contour we get a change of amplitude $0 + 4\pi + 0 = 4\pi$.

Hence there are two and only two roots in the first two quadrants. That is, there is one root in the second quadrant.

Similarly there is one in the third quadrant and one in the fourth quadrant. As a matter of fact, the four roots are $-1 \pm \sqrt{-1}$ and $2 \pm \sqrt{-1}$, as may be seen by factorising the original equation as

$$(z^2 + 2z + 2)(z^2 - 4z + 5),$$

and the localities of these roots are shown in Fig. 374.

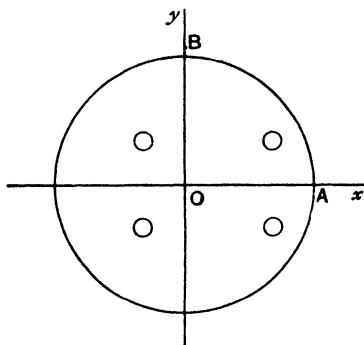

Fig. 374.

2. Consider next the equation

$$w \equiv z^6 - 6z^5 + 16z^4 - 24z^3 + 25z^2 - 18z + 10 = 0.$$

Take the same contour as in the last case.

(1) Along the x -axis from O to A $z=x$, and there is no change in the amplitude, which remains zero.

(2) Along the infinite circle w is ultimately $R^6 e^{6i\theta}$, and there is a change of amplitude $6 \times \frac{\pi}{2} = 3\pi$ in passing from A to B .

(3) Down the y -axis from B to O , $z=ir$, say.

$$\begin{aligned} \text{Hence } w &= -r^6 - 6ir^5 + 16r^4 + 24ir^3 - 25r^2 - 18ir + 10 \\ &= \rho(\cos \phi + i \sin \phi), \text{ say.} \end{aligned}$$

Then
$$\tan \phi = \frac{6r^5 - 24r^3 + 18r}{r^6 - 16r^4 + 25r^2 - 10} = \frac{6(r^2 - 1)(r^3 - 3r)}{(r^2 - 1)(r^4 - 15r^2 + 10)}$$

This indicates a peculiarity at $r = \pm 1$, i.e. $z = \pm i$; and it will appear from $w \equiv z^6 - 6z^4 + \dots + 10$ that $z^2 + 1$ is a factor and two of the roots are $z = \pm i$.

To exclude these roots we draw two small semicircles of radius r' with centres $(0, \pm 1)$ in the first and fourth quadrants as shown in the figure, thus amending our contour; (or we might, having discovered these roots, divide $z^2 + 1$ out of the expression for w and start again).

Hence, except at the point $(0, \pm 1)$, we have

$$\tan \phi = 6 \frac{r(r^2 - 3)}{r^4 - 15r^2 + 10}, \dots\dots\dots (a)$$

whence
$$\frac{1}{6} \sec^2 \phi \frac{d\phi}{dr} = - \frac{r^2 + 6r^4 + 15r^2 + 30}{(r^4 - 15r^2 + 10)^2}; \dots\dots\dots (b)$$

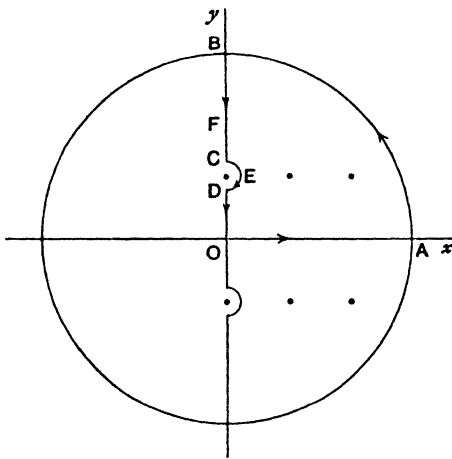

Fig. 375.

so that $\frac{d\phi}{dr}$ is negative for all positive values of r , and therefore as r decreases along the y -axis ϕ increases, with the exception of in the immediate neighbourhood of the point where $r=1$; and $\tan \phi$ vanishes both at $r=R=\infty$ and at $r=0$ as well as at $r=\sqrt{3}$.

To consider what happens in the neighbourhood of $r=1$, about which the small semicircle is drawn, put $z = i + r'e^{i\theta}$. Then to first powers of r' ,

$$w \equiv (-1 + 6ir'e^{i\theta}) - 6(i + 5r'e^{i\theta}) + 16(1 - 4ir'e^{i\theta}) - 24(-i - 3r'e^{i\theta}) + 25(-1 + 2ir'e^{i\theta}) - 18(i + r'e^{i\theta}) + 10 = 8(3 - i)r'e^{i\theta},$$

and the variable portion of the amplitude diminishes from $\theta' = \frac{\pi}{2}$ to

$\theta' = -\frac{\pi}{2}$ as z traverses the semicircle CED from C to D ; otherwise along the y -axis the value of the amplitude is always increasing from $\phi = 3\pi$ at ∞ , where $\tan \phi = 0$ to $\phi = 4\pi$ at $r = \sqrt{3}$, where $\tan \phi = 0$ again, and except for the semicircle CED to $\phi = 5\pi$ at $r = 0$, where $\tan \phi$ has again become zero, besides the loss of π in passing round the small semicircle.

Hence the change of amplitude round the whole contour is

0 from O to A , 3π from A to B , π from B to F , where $OF = \sqrt{3}$,
 π from F to O except round the semicircle CED , $-\pi$ round CED ;

i.e. in all, the change of amplitude is 4π , which indicates the existence of two roots in the first quadrant, besides the root $z = \iota$ on the boundary.

In the same way, it can be shown that there is another root $z = -\iota$, and two others in the fourth quadrant, but none in the second and third.

As a matter of fact, the expression when factorised becomes

$$(z^2 + 1)(z^2 - 2z + 2)(z^2 - 4z + 5),$$

and the roots are $\left. \begin{matrix} z = \pm \iota, \\ z = 1 + \iota, \\ z = 2 \pm \iota, \end{matrix} \right\}$ and are indicated by dots in the second and fourth quadrants in the figure and the centres of the semicircles.

3. Consider $w \equiv z^{4n+2} + z + 1 = 0$.

Taking the same contour as before :

(1) Along the x -axis $z = x$, and there is no change of amplitude in z or in w .

(2) Along the arc of the infinite circle, radius R say,

$$w = R^{4n+2} e^{i(4n+2)\theta}, \text{ where } R \text{ is very large,}$$

and the change of amplitude is $(4n+2)\frac{\pi}{2} = (2n+1)\pi$.

(3) Along the y -axis put $z = \iota r$; then

$$w = -r^{4n+2} + \iota r + 1 = \rho(\cos \phi + \iota \sin \phi), \text{ say,}$$

and

$$\tan \phi = \frac{r}{1 - r^{4n+2}}, \dots\dots\dots (a)$$

$$\sec^2 \phi \frac{d\phi}{dr} = \frac{(1 - r^{4n+2}) + (4n+2)r^{4n+1}}{(1 - r^{4n+2})^2} = \frac{1 + (4n+1)r^{4n+2}}{(1 - r^{4n+2})^2},$$

which is positive for all positive values of r . Hence, as r is decreasing as z travels from B to O down the y -axis, ϕ is also decreasing, and the decrease is from $(2n+1)\pi$ through $(2n+1)\pi - \frac{\pi}{2}$ at $r = 1$, where $\tan \phi = \infty$, to $(2n+1)\pi - \pi$ at O . That is, the total change of amplitude in passing round this contour is $2n\pi$, which indicates the existence of n roots in the first quadrant.

(4) If we take the first two quadrants as contour with an infinite semi-circular boundary, the change of amplitude is

$$0 + (4n+2)\pi + 0 = (4n+2)\pi.$$

Hence there are $2n+1$ roots in the first and second quadrants, i.e. $(n+1)$ roots in the second quadrant.

(5) Consider next the behaviour in the fourth quadrant.

For the variation of z down the y -axis, OB' , put $z = -ir$,

$$w = -r^{4n+3} - ir + 1 = \rho'(\cos \phi' + i \sin \phi'), \text{ say,}$$

$$\tan \phi' = \frac{r}{r^{4n+3} - 1},$$

$$\sec^2 \phi' \frac{d\phi'}{dr} = -\frac{(4n+1)r^{4n+3} + 1}{(r^{4n+3} - 1)^2},$$

which is essentially negative; and r is increasing, therefore ϕ' is decreasing, and $\phi' = 0$ at O , and again at B' , where $r = \infty$, and there is a loss of π in the amplitude.

In traversing $B'A$ there is, as before, an increase of $(2n+1)\pi$ in the amplitude, whilst in traversing AO there is no change.

This gives a change of $2n\pi$, which indicates the existence of n roots in the fourth quadrant. Similarly there are $n+1$ roots in the third.

Hence the localities are :

- n roots in the first and in the fourth quadrants ;
- $n+1$ roots in the second and in the third.

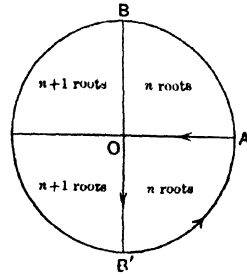

Fig. 376.

EXAMPLES.

1. Find the moduli and amplitudes of

$$(x + iy)^n, \log(x + iy), a^{x+iy}, (x + iy)^{a+ib},$$

$$\sin(x + iy), \cos(x + iy), \sec(x + iy), \tan^{-1}(x + iy).$$

2. If $z \equiv x + iy$, show that

$$\left. \begin{aligned} \log |c^z| &= x \log |c| - y \text{ amp. } c, \\ \tan \text{ amp. } c^z &= y \log |c| + x \text{ amp. } c. \end{aligned} \right\}$$

3. How are $\sin z, \log z, \tan^{-1} z$ defined when $z = x + iy$?

Show that if $z = x + iy$,

$$\frac{dz^n}{dz} = nz^{n-1}, \quad \frac{d \sin z}{dz} = \cos z, \quad \frac{d \log z}{dz} = \frac{1}{z}, \quad \frac{d \tan^{-1} z}{dz} = \frac{1}{1+z^2}.$$

4. Discuss the locality of the roots of the equations :

- (i) $w \equiv z^4 - 2z^3 + 4z + 12 = 0$;
- (ii) $w \equiv z^4 + 2z^3 - 4z + 12 = 0$;
- (iii) $w \equiv z^4 + 6z^3 + 16z^2 + 20z + 12 = 0$;
- (iv) $w \equiv z^4 - 6z^3 + 16z^2 - 20z + 12 = 0$;

stating in each case how many roots lie in each quadrant.

5. Find how many roots lie in each quadrant in the following cases:

- (i) $w \equiv z^4 + z + 1 = 0$; (ii) $w \equiv z^{4n} + z + 1 = 0$;
 (iii) $w \equiv z^5 + z + 1 = 0$; (iv) $w \equiv z^{4n+1} + z + 1 = 0$;
 (v) $w \equiv z^{4n+1} + z^2 + 1 = 0$; (vi) $w \equiv z^{4n+2} + z^2 + 1 = 0$;

6. Discuss the localities of the roots of the equations:

- (i) $w \equiv z^6 + 2z^5 + 7z^4 + 10z^3 + 14z^2 + 8z + 8 = 0$;
 (ii) $w \equiv z^5 - 6z^4 + 5z^3 - 30z^2 + 4z - 24 = 0$.

7. Examine the nature of the conformal representation of the equation $w^2 = 1 + z$ for the cases:

- (i) when z moves on the circle mod. $z = c$;
 (ii) when z moves on the straight line $y = 1 + x$;
 (iii) when z moves on the straight line $y = c$.

8. Find the radius of curvature of the hyperbola

$$x^2 \sec^2 c - y^2 \operatorname{cosec}^2 c = a^2$$

by a consideration of the conformal representation of the equation $w = a \cos z$, taking for the z -path the straight line $x = c$.

9. Supposing $a^2 w = z^3$, and a to be real, show that if z traces the curve $(x^2 + y^2)^3 = a^3(x^3 - 3xy^2)$, then w traces a circle at three times the angular rate. Deduce a formula for the radius of curvature of the above z -locus, and verify your result directly.

10. Taking the equation $w + 1 = (z + 1)^2$, show that the w -path corresponding to mod. $z = 1$ is a cardioid.

11. Examine the w -locus in the case $w = \cosh \log z$, when the z -locus is mod. $z = 1$.

12. Taking the relation $w^3 - 3w = z$, show, by putting $w = t + \frac{1}{t}$, that if t describes the circle mod. $t = k$:

- (1) the z point describes an ellipse;
 (2) the three w -points corresponding to any value of t^3 describe a confocal ellipse and form the angular points of a maximum inscribed triangle.

[HARKNESS AND MORLEY, *Theory of Functions*, p. 39.]

13. Discuss the conformal representations arising from the equation

$$w = \log z,$$

and show that the curvature at any point of the w -locus is proportional to the value of $\frac{1}{r} \frac{ds}{d\phi}$ at the corresponding point of the z -locus, ϕ being the angle between the tangent and the radius r , and ds an element of arc of the z -locus.

14. Suppose w to be any rational function of $z (\equiv x + iy)$, and that w is put into the form $p + iq$ where p and q are real. Suppose that as z travels in the positive direction round any contour Γ in the x - y plane, p/q passes through the value 0 and changes its sign k times from + to - and l times from - to +. Show that the number of roots of $w=0$ which lie within the contour is $\frac{1}{2}(k-l)$, it being further supposed that the contour is such as not to pass through any point for which both p and q vanish, and that when repeated imaginary roots of $w=0$ occur they are counted as many times over as they occur.

[CAUCHY. (See TODHUNTER, *Theory of Equations*, Art. 308.)]

15. If ϕ be the longitude and λ the latitude of a place on the surface of a sphere and $\theta \equiv \text{gd}^{-1} \lambda$:

(i) Show that the coordinates of a point X_s, Y_s of the stereographic projection of ϕ, λ are

$$\left. \begin{aligned} X_s &= ae^{-\theta} \cos \phi, \\ Y_s &= ae^{-\theta} \sin \phi, \end{aligned} \right\} \text{i.e. } X_s + iY_s = ae^{i(\phi + \theta)}.$$

(ii) If X_m, Y_m be the coordinates of the same point in a Mercator projection defined as

$$X_m = a\phi, \quad Y_m = a\theta,$$

express X_s and Y_s in terms of X_m and Y_m .

(iii) Considering the equation $w/a = e^{z/a}$ (a real), show that w is the stereographic projection of a point on the sphere, whose Mercator projection is z .

(iv) Show that the magnification in the stereographic projection $\propto (1 + \sin \lambda)^{-1}$, and in the Mercator projection $\propto \sec \lambda$

(v) Examine the stereographic and Mercator projections of:

(a) the meridians; (b) the parallels of latitude; (c) a rhumb line.

16. If $\xi + i\eta = (x + iy)^{\frac{1}{n}}$, prove that the systems of curves $r^n \cos n\theta = a^n$, $r^n \sin n\theta = b^n$, in the plane ξ - η correspond to straight lines parallel to the axes in the plane x - y , and find the value of the integral

$\int r^{2n-2} dA$ for the rectangular space included between any four of them, dA denoting an element of area. [ST. JOHN'S, 1890.]

17. In the relation $w = c \sin z$, show that the w -curve which corresponds to a rectangle $x = \pm \pi/2$, $y = \pm k$ on the z -plane is an ellipse with two narrow canals extending from the extremities of the major axis to the nearer foci, and that the interiors of the respective regions correspond. [FORSYTH, *Th. of F.*, p. 504.]

18. Writing $Z = X + iY$, where X and Y are real, and taking $Z = \sin z$, determine a simply-connected region of the plane of z which is transformed conformally into the half plane $Y > 0$.

[MATH. TRIP., 1913]

19. For the equation $\sqrt{X + iY} = \tan\left(\frac{1}{2}\pi\sqrt{x + iy}\right)$, show that we have as corresponding areas the area within the circle $X^2 + Y^2 = 1$, and that within the parabola $y^2 = 4(1 - x)$. Examine also the nature of the correspondence as regards

(i) the points on the circumference of the circle; (ii) those on the diameter $Y = 0$.

[MATH. TRIP., 1887]

20. If $z = \sin^2 \frac{1}{2}Z = \sin^2 \frac{1}{2}(X + iY)$, show that the lines $X = \text{const.}$, $Y = \text{const.}$ correspond to a system of confocal conics, and that the ratio of the areas of the triangles z_1, z_2, z_3 and Z_1, Z_2, Z_3 is proportional to the product of the distances z_1 (or z_2 or z_3) from the common foci of the system, the points Z_1, Z_2, Z_3 being the vertices of an infinitesimal triangle in the Z -plane and z_1, z_2, z_3 the vertices of the corresponding triangle on the z -plane.

[Ox. II P., 1913]

21. Show that $\zeta = (z + a)^2 / (z - a)^2$ gives one conformal representation of the semi-circular area $x^2 + y^2 \leq a^2$, $y \geq 0$ on the plane of $z = x + iy$, upon the upper half $\eta \geq 0$ of the plane $\zeta = \xi + i\eta$. Explain how to modify the formula so that $x = h$, $y = 0$ become $\xi = 0$, $\eta = 0$, and $x = x_0$, $y = y_0$ become $\xi = 0$, $\eta = 1$ ($h^2 \leq a^2$, $x_0^2 + y_0^2 < a^2$).

[MATH. TRIP. II., 1919]

CHAPTER XXX.

INTEGRATION. CAUCHY'S THEOREM ON CONTOUR INTEGRATION. TAYLOR'S THEOREM.

1266. Definition of Integration for a Function of a Complex Variable.

Let $f(z)$ be any single-valued function of z , and let any path of z on the z -plane be selected which does not pass through a point which makes $f(z)$ infinite, and along which the change in $f(z)$ is continuous.

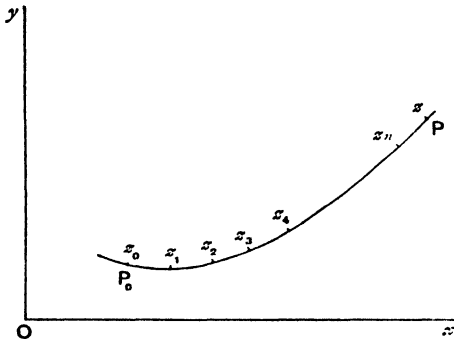

Fig. 377.

Let $z_0, z_1, z_2, \dots, z_n, z_{n+1} (=z)$ be an infinitesimally close array of points on this path from an initial point $P_0, (z_0)$, to another point $P, (z)$.

Then the limit (provided a limit exists) of the sum when n is infinite of the series

$$(z_1 - z_0)f(z_0) + (z_2 - z_1)f(z_1) + (z_3 - z_2)f(z_2) + \dots + (z - z_n)f(z_n),$$

when the moduli

$$|z_1 - z_0|, \quad |z_2 - z_1|, \quad |z_3 - z_2| \dots |z - z_n|$$

are each indefinitely decreased, so that the successive elements of the z -path are all infinitesimally small, is called the integral of $f(z) dz$ for the selected path, and is denoted by

$$\int_{z_0}^z f(z) dz.$$

1267. Obviously, the last term of the series, having an infinitesimal modulus, the series may, if desired, be supposed to stop at the term $(z_n - z_{n-1})f(z_{n-1})$, as in the case of a function of a real variable (Arts. 11 and 12).

1268. This definition clearly includes that of functions of a real variable (Art. 11) as a particular case, the "selected path" for the variation of x in that case lying upon the x -axis.

1269. General Properties of an Integral.

Properties of the integral, corresponding to those of Articles 322, etc., for a real variable, may be established. Let $w_r \equiv f(z_r)$.

Then, in the first place, it is immaterial whether we consider the limit, when n is ∞ , of

$$(z_1 - z_0)w_0 + (z_2 - z_1)w_1 + (z_3 - z_2)w_2 + \dots + (z_{n+1} - z_n)w_n \dots \equiv (A),$$

or of

$$(z_1 - z_0)w_1 + (z_2 - z_1)w_2 + (z_3 - z_2)w_3 + \dots + (z_{n+1} - z_n)w_{n+1} \dots \equiv (B).$$

For the difference of these expressions, viz. $(B) - (A)$, is

$$(z_1 - z_0)(w_1 - w_0) + (z_2 - z_1)(w_2 - w_1) + \dots + (z_{n+1} - z_n)(w_{n+1} - w_n),$$

in which the number of terms is $n+1$, which is ultimately infinite, but an infinity "of the first order," if we regard

$\frac{1}{n+1}$ as an infinitesimal of the first order.

Let the greatest of the moduli of the several terms be

$$|z_r - z_{r-1}| \times |w_r - w_{r-1}|,$$

which is finite, as the path of z has been chosen so as not to pass through a point for which w becomes infinite. Then, since the z -points are taken infinitely close to each other, and the function w is continuous for variations of z along the path, $|z_r - z_{r-1}|$ is an infinitesimal of at least the first order, and $|w_r - w_{r-1}|$ is also an infinitesimal of at least the first order.

Hence the difference of the (A) and (B) series cannot exceed the value of the product of

(an infinity of the first order) \times (an infinitesimal of the first order) \times (an infinitesimal of the first order),

i.e. a finite quantity multiplied by an infinitesimal, and must therefore vanish in the limit.

1270. It follows that if $w=f(z)$,

$$\begin{aligned} \int_{z_0}^z w \, dz &\equiv \int_{z_0}^z f(z) \, dz = \sum_{r=1}^{n+1} (z_r - z_{r-1}) f(z_{r-1}) = \sum_1^{n+1} (z_r - z_{r-1}) f(z_r) \\ &= - \sum_1^{n+1} (z_{r-1} - z_r) f(z_r) = - \int_z^{z_0} f(z) \, dz = - \int_z^{z_0} w \, dz. \end{aligned}$$

1271. Again, since the sum of the series

$$(z_1 - z_0)f(z_0) + (z_2 - z_1)f(z_1) + (z_3 - z_2)f(z_2) + \dots + (z - z_n)f(z_n)$$

may be divided into any number of portions which together make up the whole series, we have

$$\int_{z_0}^{\xi_1} f(z) \, dz + \int_{\xi_1}^{\xi_2} f(z) \, dz + \int_{\xi_2}^{\xi_3} f(z) \, dz + \dots + \int_{\xi_r}^z f(z) \, dz = \int_{z_0}^z f(z) \, dz,$$

where $\xi_1, \xi_2, \xi_3, \dots, \xi_r$ are the values of z at any points taken in order upon the selected path from z_0 to z .

1272. Again, consider $\int_{z_0}^z [f(z) \pm F(z)] \, dz$.

Provided we follow the same z -path of integration in both cases, and that both f and F are finite and continuous between the points z_0 and z on this path,

$$\int_{z_0}^z f(z) \, dz = Lt \sum_0^n (z_{r+1} - z_r) f(z_r),$$

$$\int_{z_0}^z F(z) \, dz = Lt \sum_0^n (z_{r+1} - z_r) F(z_r).$$

Hence

$$\begin{aligned} \int_{z_0}^z f(z) \, dz \pm \int_{z_0}^z F(z) \, dz &= Lt \sum_0^n (z_{r+1} - z_r) [f(z_r) \pm F(z_r)] \\ &= \int_{z_0}^z [f(z) \pm F(z)] \, dz. \end{aligned}$$

And the same is true if there be any finite number of functions.

Also, somewhat more generally, if $\Sigma A_k f_k(z)$ stand for

$$A_1 f_1(z) + A_2 f_2(z) + \dots$$

for a finite number of functions, where A_1, A_2, \dots , are all independent of z , then

$$\int_{z_0}^z \Sigma A_k f_k(z) dz = \Sigma \int_{z_0}^z A_k f_k(z) dz,$$

so long as the same z -path is followed in each integration, and the conditions as to being finite and continuous from z_0 to z are satisfied by each of the functions.

The coefficients A_k may be any whatever, provided they are not functions of z , and the number of terms in the summation is finite.

And further, in these results each function has been supposed single-valued, or if not, that the same branch is adhered to throughout the integration in each case.

1273. So long as the path of integration from z_0 to z is finite, and passes through no critical points of $f(z)$, *i.e.* points for which $f(z)$ becomes infinite, and is a continuous path so far as variations of $f(z)$ are concerned, the integral $\int_{z_0}^z f(z) dz$ must be finite.

For this integral is, by definition,

$$Lt [(z_1 - z_0)f(z_0) + (z_2 - z_1)f(z_1) + (z_3 - z_2)f(z_2) + \dots + (z - z_n)f(z_n)],$$

and, by supposition, none of the expressions $f(z_0), f(z_1), \dots, f(z_n)$ have an infinite modulus.

If $\text{mod. } f(z_r) \equiv K$, say, be the greatest of their moduli, the modulus of the integral $\int_{z_0}^z f(z) dz$, which is

$$\succ Lt \Sigma \text{mod. } (z_{r+1} - z_r) \text{mod. } f(z_r),$$

is

$$\succ Lt K \Sigma \text{mod. } (z_{r+1} - z_r),$$

and $Lt \Sigma \text{mod. } (z_{r+1} - z_r) =$ the arc of the selected path from z_0 to z , $=S$, say, which, by supposition, is finite.

Hence the modulus of the integral is not greater than $K.S$, and is therefore finite. Hence the integral itself, $\int_{z_0}^z f(z) dz$, is finite.

1274. When the number of functions $f_1(z), f_2(z), f_3(z), \dots, f_n(z)$ is infinite, the functions being each single valued, or if multiple valued, the same branch being adhered to throughout the integration, the same theorem as that of Art. 1272 is true for

their sum, provided that the sum forms a series which is uniformly and unconditionally convergent,* and provided the z -path of the integrations lies entirely within the circle of convergence and is finite; for if we write u_1, u_2, u_3, \dots for these functions, let $f(z) = u_1 + u_2 + u_3 + \dots + u_n + R_n$, where R_n is the remainder after n terms; and let the series

$$u_1 + u_2 + u_3 + \dots \text{ to } \infty$$

be uniformly and unconditionally convergent for all points within the region bounded by a circle of radius ρ , then, when n is indefinitely increased, $|R_n|$ vanishes.

$$\text{But} \quad \int_{z_0}^z \left[f(z) - \sum_1^n u_r \right] dz = \int_{z_0}^z R_n dz,$$

and if $|R'|$ be the greatest value of $|R_n|$ along the path of integration, which is finite, and which lies within and does not cut the circle of convergence, then

$$\begin{aligned} \left| \int_{z_0}^z R_n dz \right| & \text{is } \leq \int_{z_0}^z |R' dz|, \quad \text{i.e. } \leq |R'| \int_{z_0}^z |dz|, \\ & \leq |R'| \times \text{the length of the path of integration} \\ & \leq |R'| \times \text{a finite quantity,} \end{aligned}$$

and $|R'|$ is zero, by supposition, when n is made infinite;

$$\therefore \text{Lt} \left| \int_{z_0}^z R_n dz \right| = 0, \quad \text{and therefore} \quad \int_{z_0}^z R_n dz = 0,$$

$$\text{whence} \quad \int_{z_0}^z f(z) dz = \sum_1^n \int_{z_0}^z u_r dz,$$

where the path of integration is the same for each term of the series and the conditions of the series are as stated.

1275. CAUCHY'S THEOREM.

It was shown in Chapter XV. that if ϕ and ψ be any two functions of x and y which are single valued, finite, and continuous at all points x, y which lie within or upon a given closed contour Γ of the x - y plane, then

$$\iint \left(\frac{\partial \psi}{\partial x} - \frac{\partial \phi}{\partial y} \right) dx dy = \int \left(\phi \frac{dx}{ds} + \psi \frac{dy}{ds} \right) ds,$$

* A knowledge of the general theory of infinite series and tests for convergence will be assumed here. The necessary information will be found in Professor Hobson's *Plane Trigonometry*, Chapter XIV., or in the *Treatise on the Theory of Functions*, by Harkness and Morley, Chapter III.

the surface integral being taken over the area bounded by the contour and the line integral being taken round the perimeter, the direction of the integration being such that in travelling along the arc in the direction of increase of s , the area bounded by the contour is always on the left-hand side.

Consider the function $w=f(z)=f(x+iy)=u+iv$, say.

Then u and v being conjugate functions of x and y (*Diff. Calc.*, Art. 190), we have

$$\frac{\partial u}{\partial y} = -\frac{\partial v}{\partial x} \quad \text{and} \quad \frac{\partial u}{\partial x} = \frac{\partial v}{\partial y}.$$

Now, from the above theorem, we have, by two applications,

$$\int (u \, dx - v \, dy) = - \iint \left(\frac{\partial v}{\partial x} + \frac{\partial u}{\partial y} \right) dx \, dy = 0$$

and
$$\int (v \, dx + u \, dy) = \iint \left(\frac{\partial u}{\partial x} - \frac{\partial v}{\partial y} \right) dx \, dy = 0.$$

Hence
$$\begin{aligned} \int f(z) \, dz &= \int (u + iv) \, d(x + iy) \\ &= \int (u \, dx - v \, dy) + i \int (v \, dx + u \, dy) \\ &= 0, \end{aligned}$$

and the assumption in this theorem is that $f(z)$ is synectic within and upon the boundary of Γ along which the integration is conducted. That is, that $f(z)$ is a single-valued, continuous function which has no infinities, whether pole or essential singularity, within or upon the boundary of the contour. This extremely important theorem is due to Cauchy (*Comptes Rendus de l'Acad. des Sciences*, 1846).

1276. Deformation of a Path.

When w is a synectic function for a definite region Γ of the z -plane, let ACB , ADB be two z -paths which lie entirely within that region. Then it follows from Cauchy's theorem that

$$\int_A^B w \, dz \text{ (along } ADB) + \int_B^A w \, dz \text{ (along } BCA) = 0,$$

as there are no singularities in the region between the two paths.

Hence
$$\int_A^B w \, dz \text{ (along } ADB) = \int_A^B w \, dz \text{ (along } ACB).$$

Hence, as far as the value of the integral is concerned, either

path from A to B is *deformable* into the other without altering the value of $\int w dz$ along it. When one of these paths is the straight line AB itself, the other path is said to be "re-

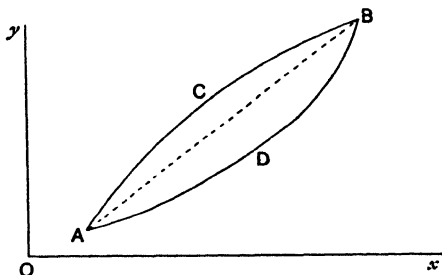

Fig. 378

concilable with" a straight-line path of integration; and it will appear that such deformation of the path from A to B can be carried to any extent, provided that this deformation does not carry any part of the path of integration outside the boundary of the region Γ on the x - y plane, for which the function $f(z)$ is synectic.

1277. Differentiation of this Integral.

Writing ξ for z and taking $f(\xi)$ as synectic throughout the singly connected region Γ of the z -plane, and starting from any selected point z_0 , viz. A in Fig. 378, and travelling along any path to z , viz. the point B , both terminals and path lying entirely within the boundary of Γ , we see that the integral $\int_{z_0}^z f(\xi) d\xi$ is independent of the path of approach of ξ to the terminal z . Let $F(z)$ stand for this integral. Then it follows that $F(z)$ is a *single-valued* function of z ; and it has been shown to be *finite* in Art. 1273. Let $z + \delta z$ be another point within the region Γ infinitesimally close to z . Then $F(z + \delta z)$, which is $\int_{z_0}^{z + \delta z} f(\xi) d\xi$, is also independent of the path of approach of ξ to $z + \delta z$. We may therefore select the same path as before from z_0 as far as the point z , together with any additional elementary path from z to $z + \delta z$ lying within the region Γ , and along this $f(\xi)$ remains finite and continuous by supposition. The difference between $f(\xi)$ and $f(z)$ for any point of this

elementary path is therefore infinitesimal, and therefore we may write $\int_z^{z+\delta z} f(\zeta) d\zeta$ as $\{f(z) + \epsilon\} \delta z$, where the modulus of ϵ is infinitesimally small, ultimately vanishing with that of δz . Wherefore $F(z + \delta z) - F(z) = \{f(z) + \epsilon\} \delta z$, and therefore the moduli of $F(z + \delta z) - F(z)$ and δz are of the same order of smallness. Hence $F(z)$ is *continuous* at the point z , i.e. at any point within the region Γ . Also $\frac{F(z + \delta z) - F(z)}{\delta z}$ has a limiting value independent of the direction of approach of $z + \delta z$ to z , viz. $f(z)$, when $|\delta z|$ is made indefinitely small. That is $F(z)$ possesses a *differential coefficient*. $F(z)$ is therefore a *synectic* function of z for all points within the region Γ .

1278. **Definition of Integration regarded as a Solution of the Differential Equation** $\frac{dy}{dz} = f(z)$.

It now appears that the integral $\int_{z_0}^z f(\zeta) d\zeta$ defined in Art. 1266 as the limit of a summation from a definite starting point z_0 to a definite terminal point z along any selected path, both path and terminals lying within the region Γ , and the terminals being not within an infinitesimal distance of its boundary, throughout which region $f(z)$ is *synectic*, is a solution of the differential equation $\frac{dy}{dz} = f(z)$, whatever the starting point z_0 may be. And supposing z_0 to have been specifically selected, we may write the general solution of this equation as $y = C + \int_{z_0}^z f(\zeta) d\zeta$, where C is the integral from any *arbitrary* point of the region Γ along any path lying within Γ to the selected point z_0 . In fact, we might regard the notation $y = C + \int_{z_0}^z f(\zeta) d\zeta$ as only another way of writing the differential equation, but one which emphasizes the interrogative character of the investigation it is proposed to conduct.

1279. **Extension of Former Definitions of Integration. Removal of Limitations.**

So long then as Γ is a singly connected region in the z -plane in which $f(z)$ has no singularities, whether poles,

essential singularities or branch-points and the path of the integration lies entirely within the contour of Γ and the terminals do not lie within an infinitesimal distance of the boundary, the identity of the summation definition with that of a solution of the differential equation $\frac{dy}{dz} = f(z)$ is established.

Seeing that we have a mode of considering any multiple-valued function of z as reduced to that of a single-valued function by means of a representation on a Riemann's Surface, and under the understanding specified as to the nature of the function, the path of the integration and the existence of a differential coefficient, we may now remove the limitations of the definition of integration as specified in Art. 17, Vol. I., as to the reality of the variable, and of the function, and the stipulated condition as to the single-valued character of the functions dealt with. We may therefore regard the functions which have been subsequently treated as subjects of integration, as functions of a complex variable with such alterations in the several definitions of those functions as may be required in individual cases to give them intelligible meanings in consonance with such as they possess when functions of a real variable.

The proofs of general propositions as to integration given in Chapter IX. (Art. 321 onwards), which were there established under the understanding as to reality of the variable and single-valuedness of the function, are now superseded for the wider conception of the nature of the variable and the function by the general propositions of Arts. 1269 to 1274.

1280. Loops.

As the property presupposed for the function w may cease to hold and the function become meromorphic at certain points of the plane by virtue of the existence of Poles, Branch Points or other singularities, it is necessary to consider, in case the specific region Γ should include such points, what paths there are in this region which are deformable into a straight-line path from any one point O , which may be considered the origin, to any other point P of the region. Also we shall have to consider how the integral $\int_0^P w dz$ is affected when the path

from O to P is not one which can be deformed into the straight path OP without passing through one of these singular points.

Imagine an infinitely extensible and contractible inelastic thread attached at the points O and P to the plane and lying in the plane. Imagine a pin stuck perpendicularly into the plane at a point A . It will be obvious that the thread might pass on either side the pin, or it might loop round it one or more times as in the paths in the diagram OXP , OSP (which is straight), OYP or OZP . In the case OXP the thread path can be deformed into the straight path OSP without moving the pin from the point A . But neither of the paths OYP , OZP can be so deformed whilst the thread lies in the plane

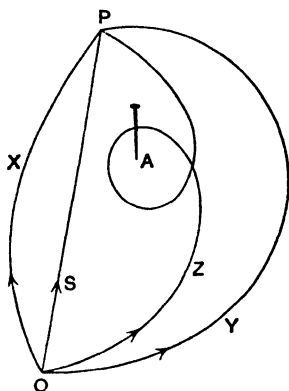

Fig. 379.

without removing the pin. The path OXP is said to be "reconcilable with" a straight-line path. But the paths OYP , OZP are not so reconcilable.

1281. The path OYP is "reconcilable with" a loop round A consisting of a straight line OB , a portion BCD of a small circle with centre at A , a straight line DO' parallel and equal to OB , and $O'P$, and the thread OYP may be deformed into this "loop and line" without crossing the pin at A .

The radius of the small circle may be regarded as any infinitesimal and the breadth of the canal BO an infinitesimal of higher order than the radius of the circle, so that the angle BAD is evanescent; the circle BCD may then be regarded as complete and the banks of the canal OB , $O'D$ as coincident. Thus B coincides with D and O' with O , and the figure will be as shown in diagram, No. 381. The portion of the deformation consisting of the small circle and the two banks of the narrow canal starting from O and terminating at O after passing once round the point A is technically known as a "Loop," and the integral $\int w dz$ taken round the circuit

$OBCDO$ will be called (A) , and if U_1 be the integral along OP the whole integral for the path will be $(A)+U_1$, the suffix in such cases denoting the number of loops that have been traversed before starting upon the portion of the path indicated by the letter to which the suffix is attached.

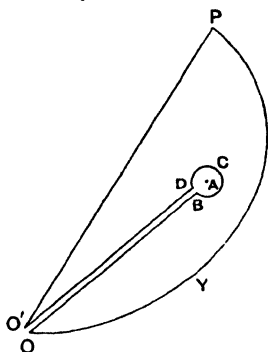

Fig. 380.

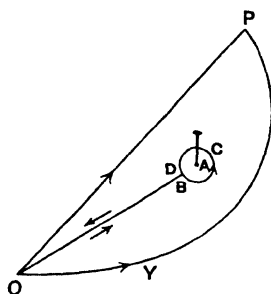

Fig. 381.

If A be an ordinary point of the plane the region within the small circle is synectic, as also along the canal, and $(A)=0$. The value of w on the return journey DO is the same as that of w on the outward path OB , and the integrations are of opposite sign and cancel; and the integral round the small circle separately vanishes.

No "loop" passes twice round the same point A without first returning to the starting point. The canal of the loop is usually but not necessarily taken straight (see Fig. 399, Art. 1294).

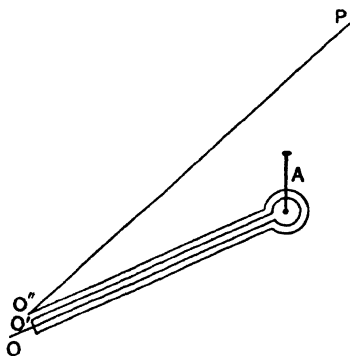

Fig. 382.

1282. If the thread initially lies as in the path Z of Fig. 379, passing round the pin twice before arriving at P , a deformation is possible into two loops + a straight path OP , as shown in Fig. 382, the points O, O', O'' being ultimately coincident. The value of the integration round this path we shall denote by $I \equiv (AA)+U_2$ or $(A^2)+U_2$.

If the thread passes round the pin n times before reaching P , the thread-path will in the same way be reconcilable with n A -loops + a linear path, and the value of the integral $\int w dz$ along it will be denoted by $I \equiv (A^n) + U_n$.

In the case of a single-valued function the suffixes used are of no account. But in the case of a multiple-valued function the return value after traversing a loop is not the same function as that with which we start encircling the loop. Hence it is necessary to keep count throughout of the number of loops passed before starting upon the next in order.

1283. Next suppose there are two pins stuck perpendicularly into the plane at A and at B . There are many varieties of thread paths along which the thread may lie from O to P .

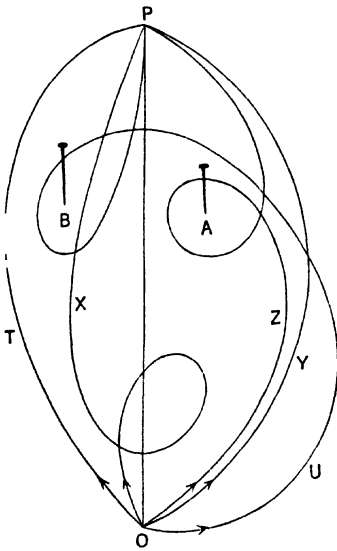

Fig. 383.

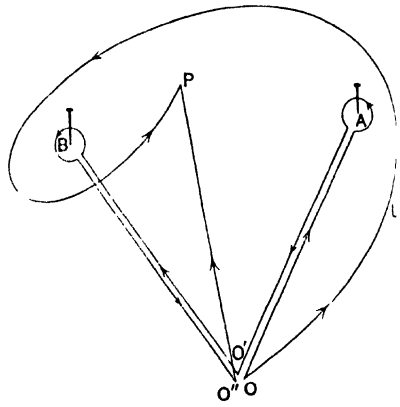

Fig. 384.

(1) It may be deformable without crossing a pin (as OXP) into the straight line OP .

(2) It may, if in position such as OYP , be deformable as before into an A -loop + a straight-line path OP . $I = (A) + U_1$.

(3) It may, if in a position such as OZP , be deformable into several A -loops + a straight-line path OP . $I = (A^n) + U_n$.

(4) It may, if in such a position as OTP , be deformable into a B -loop or into several B -loops + a straight-line path OP .

$$I = (B^n) + U_n.$$

(5) It may be that the thread path surrounds both pins several times, and then the system is deformable into a set of A -loops and a set of B -loops together with a straight path OP , in which case B may be encircled as many times as A , making each time a double circuit, or there may be more surroundings of one pin than of the other.

$$\begin{aligned} I &= (AB) + U_2 \\ \text{or } &(AB)^n + U_{2n}, \\ &(AB)^n + (A_{2n}^p) + U_{2n+p} \\ \text{or } &(AB)^n + (B_{2n}^q) + U_{2n+q}. \end{aligned}$$

The notation for the integrals will explain itself.

1284. A loop round A and then round B will be called a "double loop." This term is often confined to the case when O lies between the points in question.

A double loop is deformable as shown in Figs. 385, 386, and

$$I = (AB) + U_2.$$

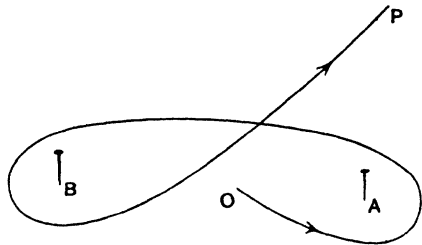

Fig. 385

In the same way, if there be several pins A, B, C, D , say four, any thread path such as $OX P$ may be deformed into four loops and a straight path, and the integration will be represented by

$$I = (A) + (B_1) + (C_2) + (D_3) + U_4 \quad (\text{Figs. 387, 388}),$$

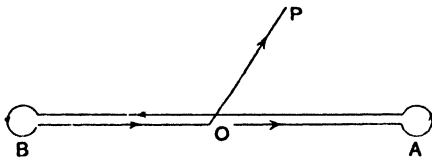

Fig. 386.

or if the thread encircles a pair of pins as in Fig. 389, the deformation and its integration will be represented by

$$I = (A) + (B_1) + (A_2) + (B_3) + (C_4) + (D_5) + U_6$$

or

$$(AB) + (AB)_6 + (C_4) + (D_5) + U_6.$$

If the thread encircles three pins ABC , as shown in Fig. 391, the deformation and the integration will be indicated by

$$I = (A) + (B_1) + (C_2) + (A_3) + (B_4) + (C_5) + (D_6) + U_7,$$

and similarly in any other case.

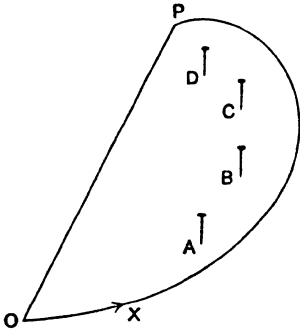

Fig. 387.

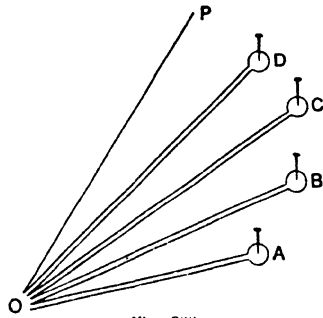

Fig. 388.

It will appear in general then that any thread path may be deformed into a system of loops + a straight-line path, however many pins there may be.

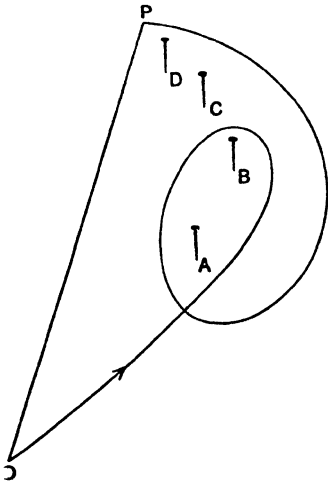

Fig. 389.

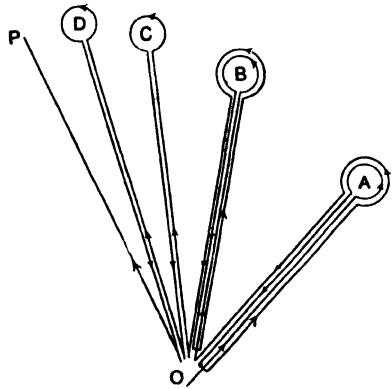

Fig. 390.

1285. Method of Exclusion of Poles.

When a pole exists within a contour Γ at a point $z=a$ and not within an infinitesimal distance of the boundary, it may

be excluded from the integration by the artifice of altering the boundary, as indicated in Fig. 392, by the introduction of a loop so as to exclude the pole from the new contour Γ' .

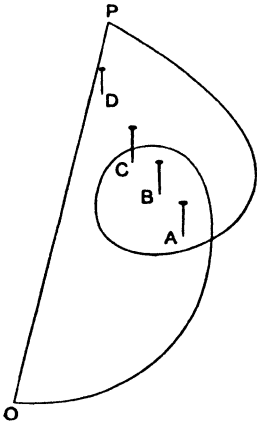

Fig. 391.

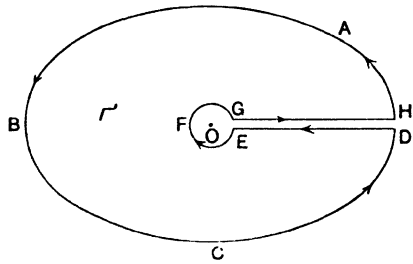

Fig. 392.

A small circle EFG is drawn with centre at the pole O (viz. $z=a$), and two adjacent points of it EG are connected with two adjacent points DH of the original contour forming a narrow canal. We then regard the boundary of the contour Γ' as the curve $ABCDEF GHA$, and integrate round the amended contour.

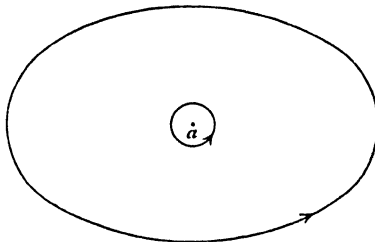

Fig. 393.

The breadth of the channel $DEGH$ may be taken as zero throughout its length, and it may be taken as straight, so that the portions of the integration of a single-valued function along DE and GH cancel each other, and it leaves us with

the theorem that $\int f(z) dz$, round the outer boundary in the sense of the arrow at A , $+$ $\int f(z) dz$ round EFG in the sense of the arrow at F , vanishes, it being supposed that $f(z)$ possesses no singularities other than that at $z=a$, which lie within the region Γ . That is, the value of $\int f(z) dz$, taken round the outer boundary in the positive sense, *i.e.* leaving the region always to the left-hand, is equal to $\int f(z) dz$, taken round the inner boundary in the same sense relatively to the region bounded by and lying within the inner contour, as indicated in Fig. 393.

1286. **The Integral** $\int \frac{\phi(z)}{z-a} dz$.

Suppose then that $f(z) = \frac{\phi(z)}{z-a}$, where $\phi(z)$ has no factor $z-a$, so that there is a pole of $f(z)$ at $z=a$, at which $f(z)$ becomes infinite, and that the point a is not within an infinitesimal distance of the nearest point of the boundary.

To consider the value of $\int f(z) dz$, taken round a small circular contour with centre $z=a$ and small radius ρ , which will not cut the boundary, put $z=a+\rho e^{i\theta}$.

Then $\frac{dz}{z-a} = i d\theta$, and if ρ be infinitesimally small we may put $\phi(z) = \phi(a)$.

$$\text{Hence } \int \frac{\phi(z)}{z-a} dz = \int \phi(a) i d\theta = i \phi(a) \int_0^{2\pi} d\theta = 2\pi i \phi(a).$$

This then is the value of the integral conducted round the small circle, which is therefore, by the previous article, the value of the integration round the outer boundary of the contour.

Thus $\int \frac{\phi(z)}{z-a} dz$, taken round the outer boundary of the contour Γ , $= 2\pi i \phi(a)$.

Supposing, however, that the point a lies upon the contour along which it is proposed to conduct the integration, at a point of the contour at which the curvature is finite and continuous, it may still be excluded by travelling round it along an infinitesimally small semicircle with centre at a and

lying within the bounded region, cutting the contour at P and Q . Then after putting, as before, $z = a + \rho e^{i\theta}$, the limits for θ will now be from $-\epsilon$ to $-(\epsilon + \pi)$, where $-\epsilon$ is the value of θ at commencing the small semicircular path at P , and $-(\epsilon + \pi)$ is the value when the contour is recommenced at Q . We then have

$$\int_Q^P \frac{\phi(z)}{z-a} dz \text{ (taken round the whole contour)} + \int_{-\epsilon}^{-(\epsilon+\pi)} \phi(a) i d\theta = 0,$$

(except the infinitesimal arc PQ)

that is, Prin. Val. of $\int \frac{\phi(z)}{z-a} dz = \pi i \phi(a)$.

1287. **The Integral** $\int \frac{\phi(z) dz}{(z-a_1)(z-a_2) \dots (z-a_r)}$.

Similarly, if there be several poles of $f(z)$ lying within the contour Γ and none of them within an infinitesimal distance of the boundary.

Suppose $z = a_1, z = a_2, \dots, z = a_r$, to be these poles.

Let $f(z) \equiv \frac{\phi(z)}{(z-a_1)(z-a_2) \dots (z-a_r)}$, where $\phi(z)$ is of degree n , say, in z , and possesses no factors $z - a_1, z - a_2, \dots$ or $z - a_r$.

By the rules of partial fractions, we have a result of the form

$$f(z) = K_{n-r} z^{n-r} + K_{n-r-1} z^{n-r-1} + \dots + K_1 z + K_0 + \sum_{s=1}^{s=r} \frac{\phi(a_s)}{(a_s-a_1)(a_s-a_2) \dots (a_s-a_r)} \frac{1}{z-a_s},$$

where the factor $a_s - a_s$ is omitted from the denominator and n is supposed not less than r , or if n be less than r the integral polynomial part is absent.

The first part of this expression, down to K_0 , constitutes a function of z with no poles within the contour Γ , and therefore its integral taken round the boundary of Γ contributes nothing to the whole integral. We may construct a loop for each of the infinities and proceed as in the case of a single infinity.

The term involving $\frac{1}{z-a_s}$, taken round a small circular contour with centre a_s , contributes to the integral

$$\frac{\phi(a_s)}{(a_s-a_1)(a_s-a_2) \dots (a_s-a_r)} \cdot 2\pi i,$$

this small circle being taken of so small a radius as to exclude all the other poles and not to cut the boundary.

Hence the whole integral taken round the contour, viz. $\int f(z) dz$, being equal to the sum of the integrals round the small circles which surround the several infinities,

$$= 2\pi i \sum_1^r \frac{\phi(a_s)}{(a_s - a_1)(a_s - a_2) \dots (a_s - a_r)};$$

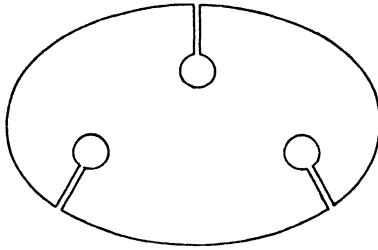

Fig. 394.

the factor $a_s - a_s$, being omitted, $= 2\pi i \sum_1^r \lambda_s$, say, where the value of λ_1 may be reproduced as $\lim_{\delta \rightarrow 0} \delta f(a_1 + \delta)$, i.e.

$$\lim_{\delta \rightarrow 0} \frac{\phi(a_1 + \delta)}{(a_1 + \delta - a_2)(a_1 + \delta - a_3) \dots (a_1 + \delta - a_r)},$$

and similarly for λ_2, λ_3 , etc.; or by the ordinary rules of partial fractions.

The effect of *pole-clusters* within a contour will be discussed in Art. 1317.

1288. Effect of a Branch Point.

If the function w be multiple-valued, say two-valued, but each branch being continuous and finite and possessing a differential coefficient at all points of a certain region Γ of the z -plane, Cauchy's theorem as to the integral of $\int w dz$ from a point A to a point B of this region along a path which does not pass beyond the boundary of Γ is still true, provided that the paths from A to B belong to the same branch of w ; and as long as the paths ACB, ADB of Fig. 378 are both finite paths of the variation of w_1 lying entirely in the region Γ , or both finite paths of the variation of w_2 , the theorem stated is still true, viz. that

$$\int w_1 dz \text{ along } ACB = \int w_1 dz \text{ along } ADB$$

and
$$\int w_2 dz \text{ along } ACB = \int w_2 dz \text{ along } ADB.$$

When, however, the z -path encircles a branch point in one of these paths from A to B , the functions w_1 and w_2 interchange values, and the integrals of $\int w dz$ along two such paths may differ.

1289. For instance, in the case of the two-valued function w defined by the equation $w^2 = 1 + z$, we have two branches

$$w_1 = +\sqrt{1+z}, \quad w_2 = -\sqrt{1+z},$$

and there is a branch point at $z = -1$, and, as will be seen later, one also at ∞ .

To examine this case, put $z = -1 + re^{i\theta}$, and let z travel round a small circle of radius r with centre at $z = -1$, and let us start with the branch

$$w_1 = +\sqrt{1+z} = +\sqrt{re^{i\theta}}.$$

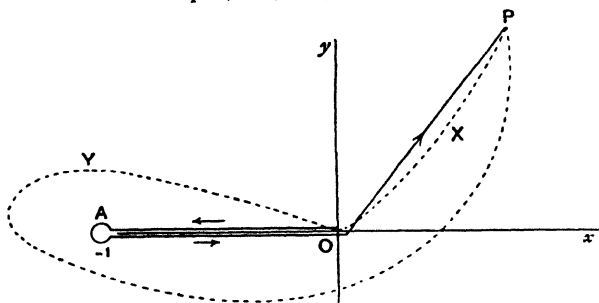

Fig. 395.

Then, in encircling the point -1 , θ increases to $\theta + 2\pi$ and $e^{i\theta}$ becomes $e^{i(\theta+2\pi)}$.

Hence w has changed from $\sqrt{re^{i\theta}}$ to $\sqrt{re^{i(\theta+2\pi)}}$, i.e. to $e^{i\pi}\sqrt{re^{i\theta}}$, and has become $-\sqrt{re^{i\theta}}$, i.e. w_2 .

Now, any path from O to P will be reconcilable with (1) a number of loops round -1 , (2) a straight-line path, and the integral will be

$$I = (A^n) + u_n.$$

Now, (1) in case of a path such as OXP , which is reconcilable with the straight line OP (Fig. 395), we have

$$I = \int_0^1 w_1 dz = u_0.$$

(2) In case of a single encirclement of the branch point

$$(A) = \int_0^{-1} w_1 dz + \int_c w_1 dz + \int_{-1}^0 w_2 dz,$$

where \int_c represents the value of the integration round the infinitesimal circle; and this $= \int_0^{2\pi} \sqrt{re^{i\theta}} (ire^{i\theta}) d\theta$, and vanishes when r is indefinitely small.

The third integral $\int_{-1}^0 w_2 dz = -\int_0^{-1} w_2 dz = \int_0^{-1} w_1 dz$, for $w_2 = -w_1$;

$$\therefore (A) = 2 \int_0^{-1} w_1 dz.$$

We thus arrive back at O with the value $w = w_2$, and with this value must continue along the line OP .

Thus,
$$u_1 = \int_0^z w_2 dz = -u_0,$$

where u_1 is the contribution of the path OP after one encirclement of A .
The whole integral is therefore

$$I = 2 \int_0^{-1} w_1 dz - u_0.$$

(3) If there be two circuits of the loop before reaching P , we have

$$\begin{aligned} I = (A) + (A_1) + u_2 &= \int_0^{-1} w_1 dz + \int_c w_1 dz + \int_1^0 w_2 dz \\ &+ \int_0^{-1} w_2 dz + \int_c w_2 dz + \int_{-1}^0 w_1 dz + \int_0^1 w_1 dz, \end{aligned}$$

which is evidently $= u_0$, and we note that $(A_1) = -(A)$.

(4) It will thus appear that if there be n circuits round the branch point,

$$I = [1 - (-1)^n] \int_0^{-1} w_1 dz + (-1)^n u_0.$$

The value of the integral $\int_0^{-1} \sqrt{1+x} dx$ is $[\frac{2}{3}(1+x)^{\frac{3}{2}}]_0^{-1} = -\frac{4}{3}$

Hence the values of the integral for the different paths are :

- (1) direct path, u_0 ;
- (2) one loop + direct path, $-\frac{4}{3} - u_0$;
- (3) two loops + direct path, u_0 ;
- (4) three loops + direct path, $-\frac{4}{3} - u_0$;

and so on, alternating in value.

Hence, if $u = \int_0^z \sqrt{1+z} dz$, and z is thence regarded as a function of u , say $z \equiv \phi(u)$, we have $z \equiv \phi(u_0) = \phi(-\frac{4}{3} - u_0)$, indicating that two values of the argument lead to one and the same value of z .

1290. In the case of any branch point at a point $z=a$ of a function $w=f(z-a)$, which is such that $Lt_{z=a}|f(z-a) dz|$ is zero, as in the case considered in Art. 1289, the contribution due to the circular portion of the loop is zero, being

$$\int_0^{2\pi} f(re^{i\theta}) \cdot ire^{i\theta} d\theta,$$

and vanishing with r , since $Lt_{r=0}|rf(re^{i\theta})|$ vanishes; and the only contribution from the loop is that due to the two banks of the canal portion of the loop.

If the function w be two-valued, it has been seen that in passing round the branch point w_1 and w_2 interchange values, and the contribution of the loop is

$$I = \int_0^a w_1 dz + \int_c w_1 dz + \int_a^0 w_2 dz;$$

and in the case considered, viz.

$$\begin{aligned} Lt_{z=a} |w_1 dz| &= 0, \\ \int_c w_1 dz &= 0, \end{aligned}$$

whilst $\int_a^0 w_2 dz = \int_0^a w_1 dz$ and $I = 2 \int_0^a w_1 dz = (A).$

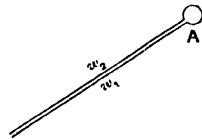

Fig. 396.

1291. More generally, if the function be n -valued, such as

$$w^n = z = r e^{i\theta},$$

so that $w = r^{1/n} [\cos(\theta + 2\lambda\pi) + i \sin(\theta + 2\lambda\pi)]^{1/n},$

where $\lambda = 0, 1, 2, \dots, n-1$, each branch $w_s = \alpha^s r^{1/n} e^{i\theta/n}$, where $\alpha =$ one of the n^{th} roots of unity, changes into

$$w_{s+1} = \alpha^{s+1} r^{1/n} e^{i\theta/n},$$

and there is a cyclical interchange of the value of w as we pass round successive branch points, so that $w_2 = \alpha w_1, w_3 = \alpha w_2$, and so on, and $\alpha^n = 1$. (See Art. 1259.)

So in this case. $I = \int_0^a w_1 dz + \int_a^0 w_2 dz$

becomes $I = (1 - \alpha) \int_0^a w_1 dz.$

1292. To return to the case of a two-valued function, if after a description of the A -loop, starting from the origin with value $w = w_1$, we pass along a second loop round another branch point B , we start off along the second loop with the value w_2 and return with the value w_1 , and for the two loops

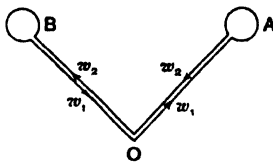

Fig. 397.

$$\begin{aligned} I &= \int_0^a w_1 dz + \int_c w_1 dz + \int_a^0 w_2 dz \\ &+ \int_0^b w_2 dz + \int_c' w_2 dz + \int_b^0 w_1 dz \\ &= 2 \int_0^a w_1 dz - 2 \int_0^b w_1 dz \\ &= (A) - (B), \text{ say,} \end{aligned}$$

and this we shall call (AB) for shortness, so that

$$(AB) = (A) - (B).$$

Similarly

$$(ABC) = (A) - (B) + (C),$$

$$(ABCD) = (A) - (B) + (C) - (D),$$

and so on.

It also appears that in a double looping of the same branch point A , we have

$$(AA) = (A) - (A) = 0.$$

In a triple looping of A ,

$$(AAA) = (A) - (A) + (A) = (A).$$

These peculiarities are indicated in the notation

$$(A^{2n}) = 0, \quad (A^{2n+1}) = (A).$$

So we have

$$(AB) = (A) - (B), \quad (BA) = (B) - (A), \quad (AB) + (BA) = 0,$$

$$(ABC) = (A) - (B) + (C) = (AB) + (C) = (AB) + (C) - (A) + (A) \\ = (AB) + (CA) + (A),$$

$$(A^2BC) = (AABC) = (A) - (A) + (B) - (C) = (BC) = (AC) + (BA),$$

$$(A^3BC) = (A) - (A) + (A) - (B) + (C) = (AB) + (C) \text{ or } (A) - (BC) \\ \text{or } (A) + (CB).$$

For a double looping of any pair,

$$(ABAB) = (A) - (B) + (A) - (B) = 2(A) - 2(B).$$

For n -encirclings of A and B we may write

$$(AB)^n = n(A - B).$$

Again, $(B) = (B) - (A) + (A) = (BA) + (A)$,

$$(BCD) = (B) - (C) + (D) = (B) - (C) + (D) - (A) + (A) \\ = (BC) + (DA) + (A).$$

1293. It appears then that to integrate round any combination of these branch points, the whole can be expressed linearly in terms of integration round any one loop, say the A -loop, together with an integration round a combination of double loops round pairs of others; and each such looping of two branch points is expressible as the difference of the integrals which accrue from integrating round each of the separate branch points of the pair. And further, that for a two-valued function the value of the function on final arrival at O , and before starting on the straight part of the path from O to P , depends upon how many times the path has

surrounded a branch point, and the final integration along the straight path adds $+u_0$ if an even number of circlings has been effected, and $-u_0$ if the number be odd.

Thus, if O be the origin, and there be branch points at A, B, C, D, E, F, G, H , a path in which B, C, A, D, E, F, A, H are successively looped before returning to O , and then passing to P , will give the integral of a two-branched function

$$(B)-(C)+(A)-(D)+(E)-(F)+(A)-(H)+(-1)^8 u_0,$$

and integration for a path for the loops round B, C, A, D, E will give

$$(B)-(C)+(A)-(D)+(E)-(A)+(A)+(-1)^7 u_0,$$

and these may be respectively written

$$(BC)+(AD)+(EF)+(AH)+u_0,$$

$$(BC)+(AD)+(EA)+(A)-u_0.$$

Now, if there be n critical points A, B, C, D, \dots , there are $n \binom{n-1}{2}$ sets of differences (we omit the brackets for short),

$$\begin{array}{cccc} A-B, & A-C, & A-D, & A-E, \dots, \\ & B-C, & B-D, & B-E, \dots, \\ & & C-D, & C-E, \dots, \\ & & & D-E, \dots, \end{array}$$

and only $n-1$ of them are independent, say

$$A-B, \quad B-C, \quad C-D, \quad D-E, \dots;$$

for any other, such as $B-E$, may be expressed as

$$(B-C)+(C-D)+(D-E).$$

Hence the value of $\int w dz$ taken along any path from O to P must take one or other of the following forms:

$$\lambda (AB)+\mu (BC)+\nu (CD)+\dots+\kappa (EF)+u_0,$$

or $\lambda' (AB)+\mu' (BC)+\nu' (CD)+\dots+\kappa' (EF)+(A)-u_0,$

where $\lambda, \mu, \nu, \dots, \lambda', \mu', \nu', \dots$, are integers, positive or negative.

1294. If there be no branch point at infinity, and if w remains finite and continuous for all other points of the z -plane, an infinite circle, with centre at the origin, will contain all the branch points, and can be deformed into a system of loops,

each passing round a branch point once, as in Fig. 398; or in case they lie in a straight line, as in Fig. 399; and the region

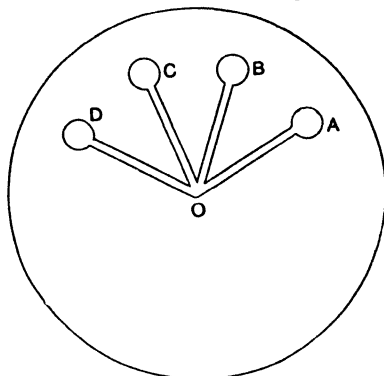

Fig. 398.

between this circle and the loop system being synectic, we have $\int w dz$, taken round the infinite circle, $= (A) - (B) + (C) - (D) + \dots$, and $\int w dz$ round the infinite circle will be a definite quantity which, in such cases as

$$w^2 = \frac{1}{(z-a_1)(z-a_2)(z-a_3)(z-a_4)}$$

$$\text{or } w^2 = \frac{1}{(z-a_1)(z-a_2)(z-a_3)(z-a_4)(z-a_5)(z-a_6)},$$

will vanish. For, taking the first of these, and putting

$$z = Re^{i\theta} \quad (R = \infty), \quad \frac{dz}{z} = i d\theta;$$

$$\therefore \int w dz = \int \frac{1}{z^2} dz = \int_0^{2\pi} \frac{i d\theta}{Re^{i\theta}} = 0, \text{ when } R = \infty;$$

and similarly in the second expression.

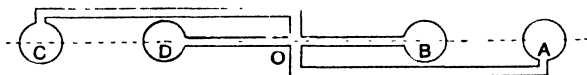

Fig. 399.

Thus in such cases there is a relation amongst these differences, viz. $(A) - (B) + (C) - (D) + \dots = 0$.

In the case of four branch points, the independent differences will reduce from three, $\{(A) - (B), (B) - (C), (C) - (D)\}$, to two, say $(A) - (B), (B) - (C)$.

And the forms possible for the value of the integration along paths from O to P will be comprised in

$$I = \lambda (AB) + \mu (BC) + u_0,$$

$$I = \lambda' (AB) + \mu' (BC) + (A) - u_0.$$

1295. Representation for Large Values of z ; Branch Points at Infinity.

To represent the nature of the function for values of z at an infinite distance from the origin, take a third variable z' , such that $zz' = 1$, and represent the travels of z' on a plane of its own. Then, for points z on the z -plane which are at great distance from the origin O , the points z' on the z' -plane are near the new origin O' on the z' -plane.

Taking the function

$$w_1 = \frac{1}{\sqrt{(z-a_1)(z-a_2)(z-a_3)\dots(z-a_n)}},$$

which is a branch of a two-valued function, let us find the branch points.

Let O be the origin on the z -plane A_1, A_2, \dots, A_n , the several points $z = a_1, z = a_2, z = a_3, \dots$, and let P be the point z .

$$\text{Let } z = a_1 + r_1 e^{i\theta_1} = a_2 + r_2 e^{i\theta_2} = a_3 + r_3 e^{i\theta_3} = \dots$$

$$\text{Then } w_1 = \frac{1}{\sqrt{r_1 r_2 r_3 \dots e^{i(\theta_1 + \theta_2 + \theta_3 + \dots)}}}.$$

Let P describe a small circle round any one of the points, say a_1 . Then, after the completion of this circle, r_1, r_2, r_3, \dots and $\theta_2, \theta_3, \theta_4, \dots$ have resumed their original values, but θ_1 has become $\theta_1 + 2\pi$.

Hence the function w_1 has become $\frac{w_1}{e^{i\pi}}$, i.e. $-w_1$ or w_2 , and therefore there is a change of branch at A_1 . Similarly at A_2, A_3, \dots . Now consider the case when $z = \infty$.

Using the other representation we have, writing $a_1 = \frac{1}{a_1'}$, $a_2 = \frac{1}{a_2'}$, etc.,

$$w_1 = \frac{1}{\sqrt{\left(\frac{1}{z'} - \frac{1}{a_1'}\right)\left(\frac{1}{z'} - \frac{1}{a_2'}\right)\dots\left(\frac{1}{z'} - \frac{1}{a_n'}\right)}} = \frac{\sqrt{a_1' a_2' a_3' \dots a_n' z'^2}}{\sqrt{(a_1' - z')(a_2' - z')\dots(a_n' - z')}},$$

and we have to consider the behaviour of this function for values of z' near the origin O' on the z' -plane.

Putting $z' = re^{i\theta}$, we have ultimately, when r is very small, $w = r^{\frac{n}{2}} e^{i \frac{n\theta}{2}}$, and when z' is made to describe a small circle of radius r about the z' -origin O' , θ' has changed by 2π , and the function becomes multiplied by $e^{in\pi}$, i.e. by

$$(\cos n\pi + i \sin n\pi) \text{ or } \cos n\pi.$$

Hence, if n be even, w_1 remains unchanged, but if n be odd w_1 changes into $-w_1$, i.e. there is a change from branch w_1 to branch w_2 .

1296. Thus, in the cases

$$w = \frac{1}{\sqrt{(z-a_1)(z-a_2)}} \quad \text{and} \quad w = \frac{1}{\sqrt{(z-a_1)(z-a_2)(z-a_3)(z-a_4)}},$$

there are respectively two and four branch points, viz. $z = a_1$ and $z = a_2$ in the first, and $z = a_1, z = a_2, z = a_3, z = a_4$ in the second, but none at ∞ .

But in the cases

$$w = \frac{1}{\sqrt{(z-a_1)(z-a_2)(z-a_3)}} \quad \text{and} \quad w_1 = \frac{1}{\sqrt{(z-a_1)(z-a_2)(z-a_3)(z-a_4)(z-a_5)}}$$

there are branch points at a_1, a_2, a_3 in the first, and at a_1, a_2, a_3, a_4, a_5 in the second, and in both these cases there is also a branch point at ∞ .

In the latter cases the loop system, when represented on the z' -plane, will be as discussed previously, the origin being also a branch point. But if represented by loops on the z -plane, we have (taking the case of three factors) a_1, a_2, a_3, ∞ as branch points at A, B, C, D respectively, the latter at infinity, and, as in Art. 1294, there are apparently three independent pairs of differences, which we may take as $(AD), (BD), (CD)$. But writing $w = \{(z-a_1)(z-a_2)(z-a_3)\}^{-\frac{1}{2}}$, we have

$$(AD) = 2 \int_{a_1}^{\infty} w dz, \quad (BD) = 2 \int_{a_2}^{\infty} w dz, \quad (CD) = 2 \int_{a_3}^{\infty} w dz,$$

and we shall show that $(BD) = (AD) + (CD)$, which reduces the three apparently independent pairs to two really independent ones. For $\int w dz$ taken round any finite contour in the finite part of the z -plane, which does not include A, B or C and cannot include D , vanishes; and such a contour is deformable into an infinite contour, such as indicated in Fig. 400, with

loops excluding the branch points. Therefore $\int w dz$ round this deformed contour also vanishes. For convenience this deformation may be taken as a circle of infinite radius centred at the origin, with four loops excluding the branch points, the canals of A, B, C being of infinite length and that of D finite. The contribution to the integral $\int w dz$ which accrues from these loops amounts to $(A) - (B) + (C) - (D)$, i.e. to $(AD) - (BD) + (CD)$. The remainder of the contour, which consists of infinite circular arcs, along each of which the same branch of w is adhered to, and which

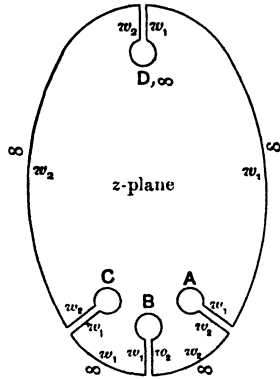

Fig. 400.

each extend from the canal of one loop to the canal of the next, contributes nothing to the integral. For taking any of these arcs, say from $\theta = a$ to $\theta = \beta$, where $z = Re^{i\theta}$ and $a < \beta < 2\pi$, we have $\int w dz = i \int_a^\beta zw d\theta$, and therefore

$$\text{mod.} \int w dz = \text{mod.} \int_a^\beta zw d\theta \asymp \int_a^\beta \text{mod.}(zw) d\theta.$$

But $\text{mod.}(zw)$ tends continually to a limit zero as $\text{mod.}z$ is indefinitely increased, and if K be its greatest value for points on the arc from $\theta = a$ to $\theta = \beta$, $\int_a^\beta \text{mod.}(zw) d\theta$ is positive and $< K(\beta - a)$, and therefore also tends to a zero limit. Hence the whole integral for the deformed contour is that due to the four loops only, viz. $(AD) - (BD) + (CD)$, which therefore vanishes. It follows that the only possible values of the integral

$$u = \int_z^\infty \frac{dz}{\sqrt{(z-a_1)(z-a_2)(z-a_3)}} \text{ are of one or other of the forms}$$

$$p(AD) + q(BD) + r(CD) + u_0,$$

or

$$p'(AD) + q'(BD) + r'(CD) + (A) - u_0,$$

where p, q , etc., are integers, and that by virtue of the relation $(BD) = (AD) + (CD)$ these further reduce to

$$\lambda(AD) + \mu(CD) + u_0 \quad \text{or} \quad \lambda'(AD) + \mu'(CD) + (A) - u_0,$$

where $\lambda, \mu, \lambda', \mu'$ are integers, and u_0 is the value of $\int_z^\infty w dz$ by any straight-line path from z to ∞ , which does not pass through A, B , or C .

1297. From these considerations it will follow that, if a quantity z be defined as $\phi(u)$, and given by

$$u = \int_0^z \frac{dz}{\sqrt{(z-a_1)(z-a_2)}} = \int_0^z w dz, \text{ say,}$$

the possible forms of the result being limited to

$$u = \lambda(AB) + u_0, \quad \text{or} \quad u = \lambda(AB) + (A) - u_0,$$

and the same point z being attained for either of these values of u , we must have, when we regard z as being expressed in terms of u ,

$$z \equiv \phi(u) = \phi[\lambda(AB) + u_0],$$

or

$$= \phi[\lambda(AB) + (A) - u_0].$$

ϕ must therefore be a periodic function such that an addition of (AB) , *i. e.* $(A) - (B)$, to the argument any number of times makes no difference, and also that, if (A) be added to any number of sets of integrals round double loops (AB) , the same will be true if the sign of u_0 be changed.

In the cases

$$u = \int_z^\infty \frac{dz}{\sqrt{(z-a_1)(z-a_2)(z-a_3)}} \quad \text{and} \quad u = \int_0^z \frac{dz}{\sqrt{(z-a_1)(z-a_2)(z-a_3)(z-a_4)}},$$

since

$$u = \lambda(AB) + \mu(BC) + u_0,$$

or

$$\lambda'(AB) + \mu'(BC) + (A) - u_0$$

in both cases, for A, B, C are any three of the four branch points, we have

$$\phi(u) = \phi[\lambda(AB) + \mu(BC) + u_0],$$

or

$$= \phi[\lambda'(AB) + \mu'(BC) + (A) - u_0],$$

and a double periodicity of $z \equiv \phi(u)$ is established.

1298. Period Parallelograms.

A geometrical illustration of this double periodicity may be given.

Let $\phi(z)$ be a doubly periodic function of a single complex variable z with independent periods ω, ω' , viz.

$$\omega = \alpha + i\beta, \quad \omega' = \alpha' + i\beta',$$

so that $\phi(z) = \phi(z + \omega) = \phi(z + 2\omega) = \dots$
 $= \phi(z + \omega') = \phi(z + 2\omega') = \dots$
 $= \phi(z + \omega + \omega') = \dots = \phi(z + p\omega + q\omega') = \dots,$

where p and q are any integers, positive or negative.

Referred to any set of rectangular axes in the z -plane, the points $(0, 0)$, (α, β) , $(\alpha + \alpha', \beta + \beta')$, (α', β') are the four corners of a parallelogram (Fig. 401).

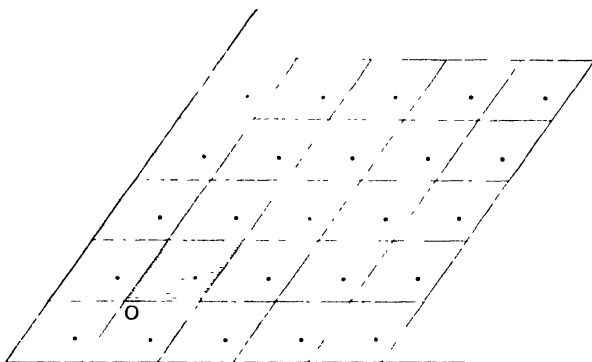

Fig. 401.

The adjacent sides of this parallelogram make angles

$$\tan^{-1} \frac{\beta}{\alpha}, \quad \tan^{-1} \frac{\beta'}{\alpha'},$$

with the x -axis. It is called a period parallelogram.

The four points, $p\alpha + iq\beta$, $(p+1)\alpha + i(q+1)\beta$,

$$\{(p+1)\alpha + \alpha'\} + i\{(q+1)\beta + \beta'\}, \quad (p\alpha + \alpha') + i(q\beta + \beta'),$$

will equally form the angular points of a parallelogram of the same size and shape as before. The whole z -plane may be regarded as mapped out into a network of such equal parallelograms by giving to p and q all integral values. As z travels over the region bounded by any one of these parallelograms, $\phi(z)$ ranges through all the values it is capable of assuming. If z travels into other parallelograms on the z -plane the values of $\phi(z)$ are merely repetitions of the values it attained at corresponding points within the first parallelogram. Thus points similarly situated with regard to any elementary parallelogram of the network give the same value of $\phi(z)$.

1299. If $\phi(z)$ be **Synectic** throughout Γ , so also are its **Differential Coefficients**.

We shall next show that, when $\phi(z)$ is synectic within and upon the boundary of a given region bounded by a closed finite contour Γ , all its differential coefficients are synectic within that region.

We have seen that if a be a point within the region and not within an infinitesimal distance of the boundary,

$$\phi(a) = \frac{1}{2\pi i} \int \frac{\phi(z)}{z-a} dz$$

taken round the boundary of Γ , where $z=a$ is not a zero of $\phi(z)$.

Let $z=a+\delta a$ be an adjacent point to $z=a$ within the contour and not infinitesimally near its boundary.

$$\text{Then} \quad \phi(a+\delta a) = \frac{1}{2\pi i} \int \frac{\phi(z)}{z-a-\delta a} dz$$

taken round the boundary of Γ , and therefore

$$\phi(a+\delta a) - \phi(a) = \frac{1}{2\pi i} \int \phi(z) \left\{ \frac{1}{z-a-\delta a} - \frac{1}{z-a} \right\} dz.$$

Now, by division,

$$\frac{1}{z-a-\delta a} = \frac{1}{z-a} + \frac{\delta a}{(z-a)^2} + \frac{(\delta a)^2}{(z-a)^2(z-a-\delta a)}.$$

Therefore

$$\phi(a+\delta a) - \phi(a) = \frac{1}{2\pi i} \int \phi(z) \left\{ \frac{\delta a}{(z-a)^2} + \frac{(\delta a)^2}{(z-a)^2(z-a-\delta a)} \right\} dz$$

round the boundary; and the definition of a differential coefficient is that it is the limit, if there be one, of

$$\frac{\phi(a+\delta a) - \phi(a)}{\delta a} \quad (\text{Art. 1239}),$$

when $|\delta a|$ is made indefinitely small. Hence we may put

$$\phi(a+\delta a) - \phi(a) = \{\phi'(a) + \epsilon\} \delta a,$$

where ϵ is something whose modulus ultimately vanishes with $|\delta a|$.

We may therefore write

$$\phi'(a) + \epsilon = \frac{1}{2\pi i} \int \phi(z) \left\{ \frac{1}{(z-a)^2} + \frac{\delta a}{(z-a)^2(z-a-\delta a)} \right\} dz$$

$$\text{or} \quad \phi'(a) - \frac{1}{2\pi i} \int \frac{\phi(z)}{(z-a)^2} dz = -\epsilon + \frac{\delta a}{2\pi i} \int \frac{\phi(z) dz}{(z-a)^2(z-a-\delta a)}, \dots (1)$$

and therefore the moduli of the two sides of this equation are equal. And since the modulus of the sum of two complex quantities is less than the sum of their moduli, and the modulus of the product is the product of the moduli, we have

$$\text{mod. [right-hand side]} < \text{mod. } \epsilon + \frac{\text{mod. } \delta a}{2\pi} \text{mod. } \int \frac{\phi(z)}{(z-a)^2(z-a-\delta a)} dz.$$

Let K be the greatest of the moduli of the values of the integrand as we travel round the boundary, which is a finite quantity since $\phi(z)$ is finite and $z-a$, $z-a-\delta a$ are not infinitesimally small. Then the modulus of the integral in this expression is less than $K \times$ Perimeter of Contour, which is a finite quantity, the perimeter being supposed of finite length;

$$\begin{aligned} \therefore \text{mod. } \left[\phi'(a) - \frac{1}{2\pi i} \int \frac{\phi(z)}{(z-a)^2} dz \right] \\ < \text{mod. } \epsilon + \frac{K}{2\pi} \cdot \text{mod. } \delta a \times \text{Perimeter of Contour.} \end{aligned}$$

Hence diminishing $\text{mod. } \delta a$ indefinitely,

$$\text{mod. } \left[\phi'(a) - \frac{1}{2\pi i} \int \frac{\phi(z)}{(z-a)^2} dz \right] = 0.$$

Therefore
$$\phi'(a) = \frac{1}{2\pi i} \int \frac{\phi(z)}{(z-a)^2} dz,$$

the integration being in all cases taken round the boundary of the contour.

In the same way we may prove

$$\phi''(a) = \frac{2!}{2\pi i} \int \frac{\phi(z)}{(z-a)^3} dz, \quad \text{etc.}$$

For if $z = a + \delta a$ be a point within the contour and not within an infinitesimal distance of the boundary, we have

$$\phi'(a + \delta a) = \frac{1}{2\pi i} \int \frac{\phi(z)}{(z-a-\delta a)^2} dz,$$

$$\begin{aligned} \text{and } \frac{\phi'(a + \delta a) - \phi'(a)}{\delta a} &= \frac{1}{2\pi i} \int \phi(z) \left[\frac{1}{(z-a-\delta a)^2} - \frac{1}{(z-a)^2} \right] dz \\ &= \frac{1}{2\pi i} \int \phi(z) \left[\frac{2}{(z-a)^3} \right] dz + \theta, \end{aligned}$$

where $\text{mod. } \theta$ vanishes with $\text{mod. } \delta a$,

$$= \frac{2!}{2\pi i} \int \frac{\phi(z)}{(z-a)^3} dz + \theta.$$

It appears therefore

(1) that $\frac{\phi'(a+\delta a) - \phi'(a)}{\delta a}$ approaches to and ultimately differs by less than any conceivable quantity from $\frac{2!}{2\pi i} \int \frac{\phi(z)}{(z-a)^3} dz$, when mod. δa is made to diminish indefinitely without reference to the way in which the indefinite approach of the point $a+\delta a$ to the point a is conducted. Hence $\phi'(a)$ is a function of a which *possesses a differential coefficient*;

(2) since $\phi(a)$ and $\phi(a+\delta a)$ are by supposition single-valued, the expression $\frac{\phi(a+\delta a) - \phi(a)}{\delta a}$ is also single-valued, and also its limit; so $\phi'(a)$ is *single-valued*;

(3) $\phi'(a)$ is *finite*; for its equivalent $\frac{1}{2\pi i} \int \frac{\phi(z)}{(z-a)^2} dz$ is such that the integrand is finite for all points upon the contour, since the point a is not at an infinitesimal distance from the boundary, and the boundary itself is of finite length by supposition;

(4) for any positive infinitesimal change in $|\delta a|$ there is a change

$$|\{\phi'(a+\delta a) - \phi'(a)\}| \propto |\delta a| \cdot \left\{ \frac{2!}{2\pi i} \int \frac{\phi(z)}{(z-a)^2} dz + \theta \right\}$$

of the same order as $|\delta a|$ in $|\phi'(a)|$. Hence $\phi'(a)$ is *continuous*.

Hence $\phi'(a)$ has a *differential coefficient* at the point a , is *single-valued*, is *finite* and is *continuous*. It is therefore *synectic* at any point a within the specified region for which $\phi(a)$ is *synectic*.

$$\text{Also} \quad \phi''(a) = \frac{2!}{2\pi i} \int \frac{\phi(z)}{(z-a)^3} dz,$$

the integration proceeding, as before, round the boundary. And the argument may now be repeated with this result to establish the successive equations,

$$\phi'''(a) = \frac{3!}{2\pi i} \int \frac{\phi(z)}{(z-a)^4} dz \dots \phi^{(n)}(a) = \frac{n!}{2\pi i} \int \frac{\phi(z)}{(z-a)^{n+1}} dz, \dots,$$

all of which functions are *synectic* in the region for which $\phi(a)$ is *synectic*.

1300. **Taylor's and Maclaurin's Theorem.**

We may now proceed to establish Taylor's Theorem for the expansion of $f(a+h)$. Let $f(z)$ be any function of z which is synectic within and upon a given circle C with centre at $z=a$ and radius ρ , and suppose $z=a$ not to be a zero of $f(z)$. Let $a+h$ be another point within this contour and not within an infinitesimal distance of the boundary.

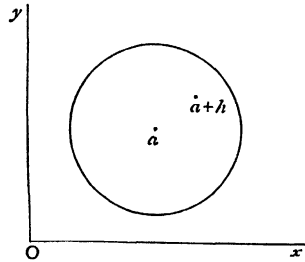

Fig. 402.

Then

$$f(a+h) = \frac{1}{2\pi i} \int_{z-a-h}^{f(z)} dz,$$

the integration being conducted round the boundary.

Now, by division,

$$\frac{1}{z-a-h} = \frac{1}{z-a} + \frac{h}{(z-a)^2} + \frac{h^2}{(z-a)^3} + \dots$$

$$+ \frac{h^n}{(z-a)^{n+1}} + \frac{h^{n+1}}{(z-a)^{n+1}} \frac{1}{z-a-h};$$

$$\therefore f(a+h) = \frac{1}{2\pi i} \int f(z) \left[\frac{1}{z-a} + \frac{h}{(z-a)^2} + \frac{h^2}{(z-a)^3} + \dots \right. \\ \left. + \frac{h^n}{(z-a)^{n+1}} + \frac{h^{n+1}}{(z-a)^{n+1}} \frac{1}{z-a-h} \right] dz$$

$$= \frac{1}{2\pi i} \left[\int \frac{f(z)}{z-a} dz + h \int \frac{f(z)}{(z-a)^2} dz + h^2 \int \frac{f(z)}{(z-a)^3} dz + \dots \right. \\ \left. + h^n \int \frac{f(z)}{(z-a)^{n+1}} dz \right] + \frac{h^{n+1}}{2\pi i} \int \frac{f(z) dz}{(z-a)^{n+1}(z-a-h)}$$

$$= f(a) + hf'(a) + \frac{h^2}{2!} f''(a) + \dots + \frac{h^n}{n!} f^{(n)}(a) + R_n,$$

where $R_n = \frac{h^{n+1}}{2\pi i} \int \frac{f(z)}{(z-a)^{n+1}(z-a-h)} dz$ taken round the circle; and putting $z = a + \rho e^{i\theta}$, we have

$$R_n = \frac{h^{n+1}}{2\pi \rho^n} \int \frac{f(z)}{z-a-h} e^{-ni\theta} d\theta.$$

Let the greatest value of $\left| \frac{f(z)}{z-a-h} \right| e^{-ni\theta}$ be K , which is finite since $|f(z)|$ is finite at all points within the circle, and the point $z=a+h$ is not within an infinitesimal distance of the boundary.

$$\text{Then} \quad |R_n| \geq \frac{1}{2\pi} \left| \frac{h^{n+1}}{\rho^n} \right| \int_0^{2\pi} K d\theta,$$

$$\text{i.e.} \quad |R_n| \geq \left| \frac{h}{\rho} \right|^n \cdot |h| \cdot K,$$

and $|h| < \rho$, so this may be made less than any assignable quantity, however small, by increasing n indefinitely.

Hence the convergency within the circle of radius ρ is established, and the usual form of Taylor's theorem still holds for a complex, viz.

$$f(a+h) = f(a) + hf'(a) + \frac{h^2}{2!} f''(a) + \dots \text{ to } \infty$$

for all points within a circle of centre a and radius $> |(a+h)|$, provided $f(z)$ is synectic for all points within this region.

If the origin be at the point $z=a$, i.e. $a=0$, we have the same result as for Maclaurin's theorem for a real variable, viz.

$$f(h) = f(0) + hf'(0) + \frac{h^2}{2!} f''(0) + \dots,$$

with the same limitations as before.

1301. Definite Integrals obtained by Contour Integration.

Cauchy's Theorem of Art. 1275 is of great use in establishing in a rigorous manner many results in definite integrals and in furnishing new results. In such investigations the form of w as a function of z is at our choice, and the particular contour of integration is also at our choice.

Consider the integration of $\int \frac{dz}{z-a}$ round any closed contour, a being supposed real.

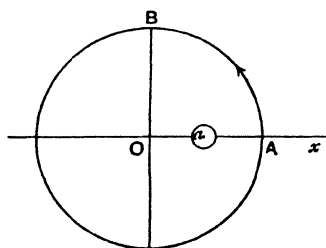

Fig. 403.

It follows from Arts. 1275 and 1286, that the result of this integration is

- (1) $2\pi i$, (2) πi or (3) 0,

according as

- (1) the contour encloses the point $z=a$;
- (2) the contour passes through $z=a$ with continuous curvature at the point;
- (3) the contour is such that $z=a$ lies outside it.

Take as contour a circle of radius R (drawn as a in the figure) and centred at the origin.

Put $z = Re^{i\theta}$; then $dz = iRe^{i\theta} d\theta$;

$$\therefore \int_0^{2\pi} \frac{Re^{i\theta} \cdot i d\theta}{Re^{i\theta} - a} = 2\pi i, \pi i \text{ or } 0, \text{ as } R > a, = a \text{ or } < a;$$

whence $\int_0^{2\pi} \frac{Re^{i\theta}(Re^{-i\theta} - a)}{R^2 - 2aR \cos \theta + a^2} d\theta = 2\pi, \pi \text{ or } 0$ in the three cases;

whence $\int_0^{2\pi} \frac{R - a \cos \theta}{R^2 - 2aR \cos \theta + a^2} d\theta = \frac{2\pi}{R} (R > a), \frac{\pi}{R} (R = a), 0 (R < a),$

and $\int_0^{2\pi} \frac{\sin \theta}{R^2 - 2aR \cos \theta + a^2} d\theta = 0$

in any of the cases, results which may be readily verified by direct integration.

1302. Consider the integration of $w \equiv \frac{e^{ikz}}{z}$, where k is real and positive, round a contour bounded by (1) an infinite semicircle BCD , centre at the origin of the x - y axes, radius R ($= \infty$), (2) a small semicircle EFA , centre at the origin and radius r , concave in the same direction as the former, and (3) the two intercepted portions of the x -axis, viz. DE and AB .

w has a pole at the origin. The small semicircle excludes this pole. Examine the behaviour of the function when z is infinite.

Let $z = Re^{i\theta}$. Then $w = \frac{e^{i k R e^{i\theta}}}{Re^{i\theta}} = \frac{e^{-kR \sin \theta} \{ \cos(kR \cos \theta) + i \sin(kR \cos \theta) \}}{Re^{i\theta}}$,

and therefore vanishes in the limit when R is increased indefinitely, so long as $\sin \theta$ is not negative; that is from $\theta = 0$ to $\theta = \pi$ inclusive. There is no pole in the region described, and w is synectic throughout the region. The total integral $\int w dz$ taken round this perimeter therefore vanishes. To estimate this we consider the integrations:

- (1) from r to R ($= \infty$) along the x -axis;
- (2) from $\theta = 0$ to $\theta = \pi$ round the great semicircle BCD ;
- (3) from $-R$ to $-r$ along the x -axis;
- (4) from $\theta = \pi$ to $\theta = 0$ round the small semicircle EFA .

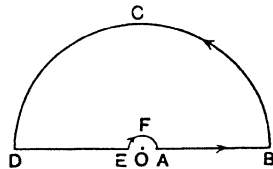

Fig. 404.

(1) Along AB , $y = 0$ and $dz = dx$, and the corresponding contribution to the whole integral is $\int_r^\infty \frac{e^{ikx}}{x} dx$.

(2) Along BCD , $R = \text{constant}$, $z = Re^{i\theta}$, $\frac{dz}{z} = i d\theta$, and the contribution to the whole is

$$\int \frac{e^{ikz}}{z} dz = \int_0^\pi e^{i k R e^{i\theta}} i d\theta = \int_0^\pi i e^{-kR \sin \theta} \{ \cos(kR \cos \theta) + i \sin(kR \cos \theta) \} d\theta,$$

which ultimately vanishes when R increases indefinitely. Therefore there is no contribution from this part of the integration.

(3) Along DE , $\int \frac{e^{kz}}{z} dz = \int_{-\infty}^{-r} \frac{e^{kx}}{x} dx$, and as x is negative we write $-x$ for x ,

$$= - \int_r^{\infty} \frac{e^{-kx}}{x} dx,$$

which is the contribution for this portion DE of the integration.

(4) Round the small semicircle the contribution is $\int_{\pi}^0 e^{ikre^{i\theta}} i d\theta$, and r being infinitesimally small this becomes $-\int_0^{\pi} i d\theta = -\pi i$.

Hence, summing up,

$$\int_r^{\infty} \frac{e^{kx}}{x} dx + 0 - \int_r^{\infty} \frac{e^{-kx}}{x} dx - \pi i = 0,$$

i.e. in the limit when r is indefinitely diminished,

$$\int_0^{\infty} \frac{e^{kx} - e^{-kx}}{x} dx = i\pi \quad \text{or} \quad \int_0^{\infty} \frac{\sin kx}{x} dx = \frac{\pi}{2},$$

k being supposed positive, which is in accord with the result of Art. 993.

1303. Consider $\int \frac{e^{kz}}{z-a} dz$, where k is a real positive quantity and a is a complex, viz. $a + i\beta$, in which β is positive.

We take as contour the x -axis, an infinite semicircle whose centre is at the origin and radius R ($=\infty$), and an infinitesimal circle of radius r , and centre at the real point (a, β) , which, since β is positive, lies within the great semicircle.

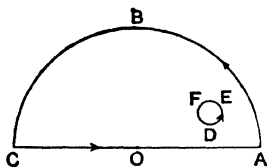

Fig. 405.

There is a pole at $z=a$, which is excluded by the small circle. Examine the behaviour of $w = \frac{e^{kz}}{z-a}$, when z is infinite. Put $z = Re^{i\theta}$.

Then $w = \frac{e^{-kR \sin \theta} \{\cos(kR \cos \theta) + i \sin(kR \sin \theta)\}}{Re^{i\theta} - a}$, and therefore, as in

the last case, ultimately vanishes when R is indefinitely increased, provided θ lies between 0 and π inclusive.

There is no pole in the region between the two circles, and w is synectic throughout it; and $\int w dz = 0$ when taken round the boundaries in opposite directions.

(1) Along the x -axis $z=x$, and we have as the part contributed by integrating from C to A , i.e. $-\infty$ to ∞ ,

$$\begin{aligned} \int_{-\infty}^{\infty} \frac{e^{kx}}{x-a-i\beta} dx &= \int_{-\infty}^{\infty} \frac{(x-a+i\beta)(\cos kx + i \sin kx)}{(x-a)^2 + \beta^2} dx \\ &= \int_{-\infty}^{\infty} \frac{\{(x-a) \cos kx - \beta \sin kx\}}{(x-a)^2 + \beta^2} dx + i \int_{-\infty}^{\infty} \frac{(x-a) \sin kx + \beta \cos kx}{(x-a)^2 + \beta^2} dx. \end{aligned}$$

(2) Round the infinite semicircle, we have a contribution

$$\int_0^\pi \frac{e^{ikR e^{i\theta}}}{R e^{i\theta} - a} R e^{i\theta} i d\theta = \int_0^\pi \frac{e^{-kR \sin \theta} \{ \cos(kR \cos \theta) + i \sin(kR \cos \theta) \}}{R e^{i\theta} - a} R e^{i\theta} i d\theta,$$

which, by virtue of the ultimately zero factor $e^{-kR \sin \theta}$, adds nothing, R being absolutely infinite and $\sin \theta$ positive.

(3) Round the infinitesimal circle DEF , put $z = a + r e^{i\theta}$.

The integration round the perimeter must give $2\pi i e^{ik(a+i\beta)}$, according to the general result of Art. 1286, i.e. $= 2\pi (i \cos ka - \sin ka) e^{-k\beta}$; whence, as $\int f(z) dz$ round the outer boundary $ABCOA$ is equal to that round DEF in the same sense, we have by equating real and imaginary parts,

$$\left. \begin{aligned} \int_{-\infty}^{\infty} \frac{(x-a) \cos kx - \beta \sin kx}{(x-a)^2 + \beta^2} dx &= -2\pi e^{-k\beta} \sin ka, \\ \int_{-\infty}^{\infty} \frac{(x-a) \sin kx + \beta \cos kx}{(x-a)^2 + \beta^2} dx &= 2\pi e^{-k\beta} \cos ka, \end{aligned} \right\}$$

which may be written

$$\left. \begin{aligned} \int_{-\infty}^{\infty} \frac{\cos \left(kx + \tan^{-1} \frac{\beta}{x-a} \right)}{\sqrt{(x-a)^2 + \beta^2}} dx &= -2\pi e^{-k\beta} \sin ka, \\ \int_{-\infty}^{\infty} \frac{\sin \left(kx + \tan^{-1} \frac{\beta}{x-a} \right)}{\sqrt{(x-a)^2 + \beta^2}} dx &= 2\pi e^{-k\beta} \cos ka. \end{aligned} \right\}$$

1304. In the case where $\beta = 0$, the centre of the small circle lies on the x -axis and a semicircular arc DEF , of radius r and centre at a , 0, replaces the complete small circle before considered.

To consider the effect of this, we integrate :

- (1) from C to D , (2) round DEF ,
- (3) from F to A , (4) round ABC .

For (1) and (3), we have

$$\left(\int_{-\infty}^{a-r} + \int_{a+r}^{\infty} \right) \frac{e^{ikx}}{x-a} dx,$$

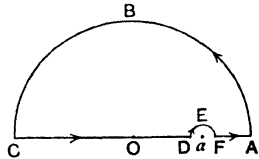

i.e. when r is infinitesimally small, viz. the Principal Value of

$$\int_{-\infty}^{\infty} \frac{e^{ikx}}{x-a} dx.$$

For (2), putting $z = a + r e^{i\theta}$, $\frac{dz}{z-a} = i d\theta$, and the contribution is

$$\int_{\pi}^0 e^{ik(a+r e^{i\theta})} i d\theta = -\pi i e^{ika},$$

r being infinitesimal.

For (4) we have, as before, a contribution nil.

Hence ultimately, r being indefinitely small,

$$\int_{-\infty}^{\infty} \frac{\cos kx + i \sin kx}{x-a} dx - \pi(i \cos ka - \sin ka) = 0,$$

i.e.
$$\left. \begin{aligned} \int_{-\infty}^{\infty} \frac{\cos kx}{x-a} dx &= -\pi \sin ka, \\ \int_{-\infty}^{\infty} \frac{\sin kx}{x-a} dx &= \pi \cos ka, \end{aligned} \right\} \begin{array}{l} \text{Principal Values being taken in} \\ \text{each case.} \end{array}$$

1305. Consider the integration $\int \frac{e^{iaz} - e^{ibz}}{z} dz$, a and b being real and positive, taken round a contour consisting of

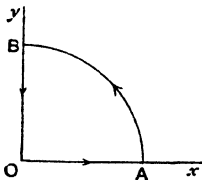

Fig. 407.

- (1) the positive portion of the x -axis;
- (2) an infinite quadrantal arc, centre at the origin and radius R ($= \infty$);
- (3) the positive portion of the y -axis;

As in the last two cases, the function vanishes in the limit when $|z| = \infty$, and it will be clear that there is no pole in the region round which it is proposed to integrate.

We have then

$$\int_0^R \frac{e^{iax} - e^{ibx}}{x} dx + \int_0^{\frac{\pi}{2}} \frac{e^{iaR e^{i\theta}} - e^{ibR e^{i\theta}}}{1} i d\theta + \int_R^0 \frac{e^{-ay} - e^{-by}}{y} dy = 0.$$

The first integral $= \int_0^R \frac{(\cos ax - \cos bx) + i(\sin ax - \sin bx)}{x} dx.$

The second integral $= \int_0^{\frac{\pi}{2}} [e^{-aR \sin \theta} e^{iaR \cos \theta} - e^{-bR \sin \theta} e^{ibR \cos \theta}] i d\theta$, which vanishes when $R = \infty$ by virtue of the exponential factors $e^{-aR \sin \theta}$ $e^{-bR \sin \theta}$, for $\sin \theta$ is positive.

The third integral $= -\log \frac{b}{a}$ by Frullani's Theorem, or by the summation definition of an integration as in Ex. 1, Art. 16.

Hence we obtain in the limit, when $R = \infty$,

$$\int_0^{\infty} \frac{\cos ax - \cos bx}{x} dx = \log \frac{b}{a}, \quad \int_0^{\infty} \frac{\sin ax - \sin bx}{x} dx = 0,$$

results previously established.

1306. Consider the integral $\int \frac{z^{a-1}}{1+z} dz$, where a is real and < 1 and > 0 , where by z^{a-1} we understand that particular one of its values whose amplitude is $(a-1)$ times that of z .

There are two poles, $z=0$ and $z=-1$. There are also branch points at the origin and at ∞ .

Take as contour an infinitely large semicircle, radius R ($= \infty$) and centre at O , the origin; an infinitesimally small semicircle of radius ρ and centre

O ; an infinitesimally small semicircle with centre at $z = -1$ and radius ρ , the concavities of the circles all being in the same direction ; and the remaining portions of the boundary being the intercepted portions of the x -axis ; the whole making the figure $ABCDEFGHIJA$ (Fig. 408), within which, with the meaning indicated for z^{a-1} , the function is syntenic.

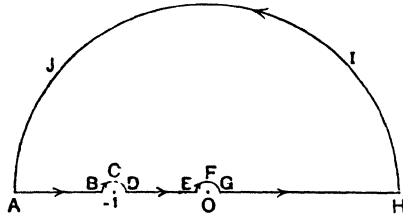

Fig. 408.

The poles are then excluded from the contour, and the integration is to be conducted along the six parts AB , BCD , DE , EFG , GH , HJA indicated in the figure.

(1) Along AB the integral is $\int_{-R}^{-1-\rho} \frac{x^{a-1}}{1+x} dx$, or changing x to $-x$,

$$-\int_R^{1+\rho} \frac{(-1)^{a-1} x^{a-1}}{1-x} dx \quad \text{or} \quad -e^{i a \pi} \int_{1+\rho}^{\infty} \frac{x^{a-1}}{1-x} dx.$$

(2) Along the semicircle BCD , put $z = -1 + \rho e^{i \theta}$; $\therefore \frac{dz}{z+1} = i d \theta$.

The contribution is then $\int_{\pi}^0 (-1 + \rho e^{i \theta})^{a-1} i d \theta$, or since ρ is infinitesimally small,

$$(-1)^{a-1} \int_{\pi}^0 i d \theta = (-1)^a i \pi = i \pi e^{i a \pi}.$$

(3) Along the straight line DE the portion of the integral is

$$\int_{-1+\rho}^{-\rho} \frac{x^{a-1}}{1+x} dx, \quad \text{or changing } x \text{ to } -x,$$

$$-\int_{1-\rho}^{\rho} \frac{(-1)^{a-1} x^{a-1}}{1-x} dx \quad \text{or} \quad e^{i a \pi} \int_{1-\rho}^{\rho} \frac{x^{a-1}}{1-x} dx.$$

(4) Along the semicircle EFG we have, putting $z = \rho e^{i \theta}$,

$$\int_{\pi}^0 \frac{(\rho e^{i \theta})^{a-1} i \rho e^{i \theta} d \theta}{1 + \rho e^{i \theta}},$$

which vanishes, ρ being an infinitesimal and $1 > a > 0$.

(5) The contribution from GH is $\int_{\rho}^{\infty} \frac{x^{a-1}}{1+x} dx$.

(6) For the semicircle HJA we have, putting $z = R e^{i \theta}$,

$$\int_0^{\pi} \frac{(R e^{i \theta})^{a-1} i R e^{i \theta} d \theta}{R e^{i \theta} + 1},$$

which vanishes, since R is infinite and $1 > a > 0$.

Let I_1 and I_2 be the Principal Values of $\int_0^{\infty} \frac{x^{a-1}}{1+x} dx$ and $\int_0^{\infty} \frac{x^{a-1}}{1-x} dx$, i.e.

$$Lt_{\rho=0} \int_{\rho}^{\infty} \frac{x^{a-1}}{1+x} dx \quad \text{and} \quad Lt_{\rho=0} \left[\int_0^{1-\rho} + \int_{1+\rho}^{\infty} \right] \frac{x^{a-1}}{1-x} dx \quad \text{respectively};$$

we then have, summing up the six portions,

$$-e^{i a \pi} \int_{1+\rho}^{\infty} \frac{x^{a-1}}{1-x} dx + i \pi e^{i a \pi} + e^{i a \pi} \int_{1-\rho}^{\rho} \frac{x^{a-1}}{1-x} dx + 0 + \int_{\rho}^{\infty} \frac{x^{a-1}}{1+x} dx + 0 = 0$$

and
$$\int_{1-\rho}^{\rho} \frac{x^{a-1}}{1-x} dx = - \int_{\rho}^{1-\rho} \frac{x^{a-1}}{1-x} dx,$$

so that
$$- \int_{1+\rho}^{\infty} \frac{x^{a-1}}{1-x} dx + \int_{1-\rho}^{\rho} \frac{x^{a-1}}{1-x} dx = - \left(\int_{\rho}^{1-\rho} + \int_{1+\rho}^{\infty} \right) \frac{x^{a-1}}{1-x} dx,$$

and in the limit, when ρ is indefinitely diminished, becomes $= -I_2$;

$$\therefore -e^{i a \pi} I_2 + i \pi e^{i a \pi} + I_1 = 0,$$

i.e.
$$-(\cos a \pi + i \sin a \pi) I_2 + \pi (\cos a \pi - i \sin a \pi) + I_1 = 0;$$

whence

$$\left. \begin{aligned} I_1 - \cos a \pi I_2 &= \pi \sin a \pi, \\ -I_2 \sin a \pi + \pi \cos a \pi &= 0; \end{aligned} \right\}$$

therefore $I_1 = \pi \operatorname{cosec} a \pi$ and $I_2 = \pi \cot a \pi$.

These are the results of Articles 871 and 1103.

1307. Consider $\int \frac{e^{iaz}}{b^2+z^2} dz$ for real and positive values of a and b .

There are poles at $z = \pm ib$; and when $|z| = \infty$ the integrand vanishes.

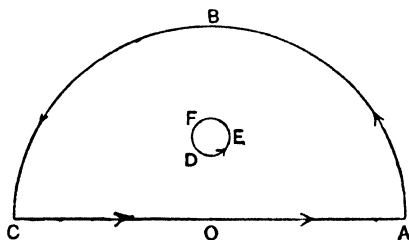

Fig 409.

Integrate round an infinite semicircle with centre at the origin O and radius $R (= \infty)$, and round a circle of infinitesimal radius ρ with centre at the pole ib .

Then the integral taken round the outer boundary = the integral taken in the same sense round the inner boundary, and the latter is

$$2\pi i \frac{e^{ia(ib)}}{ib+ib} = \frac{\pi}{b} e^{-ab}. \quad (\text{Art. 1286.})$$

Over the outer boundary we have

$$\int_{-\infty}^{\infty} \frac{e^{iaz}}{b^2+z^2} dx + \int_0^{\infty} \frac{e^{iaz}}{b^2+x^2} dx + \int_0^{\pi} \frac{e^{iaR e^{i\theta}}}{b^2+R^2 e^{2i\theta}} \cdot iR e^{i\theta} d\theta.$$

Writing $-x$ for x in the first integral, it becomes

$$-\int_{\infty}^0 \frac{e^{-iax}}{b^2+x^2} dx, \quad \text{i.e.} \int_0^{\infty} \frac{e^{-iax}}{b^2+x^2} dx,$$

and the first two integrals combine to give $\int_0^{\infty} \frac{2 \cos ax}{b^2+x^2} dx$.

The third integral is $\int_0^{\pi} \frac{e^{-aR \sin \theta} e^{iaR \cos \theta}}{b^2+R^2 e^{2i\theta}} iR e^{i\theta} d\theta$, and vanishes by virtue of the factor $e^{-aR \sin \theta}$, when R is infinite, $\sin \theta$ being positive.

Thus, summing up, we have

$$\int_0^{\infty} \frac{\cos ax}{b^2+x^2} dx = \frac{\pi}{2b} e^{-ab},$$

the result of Art. 1048

1308. Consider the integration of $w = \frac{ze^{iaz}}{b^2+z^2}$ for real and positive values of a and b .

The poles are at $z = \pm ib$; and when $|z| = \infty$ the integrand vanishes. Take the same contour as in the last example.

The integral round the small circle, whose centre is ib ,

$$= 2\pi i \frac{ib e^{ia(ib)}}{ib+ib} = \pi i e^{-ab}.$$

Over the outer boundary we have

$$\int_{-\infty}^0 \frac{x e^{iax}}{b^2+x^2} dx + \int_0^{\infty} \frac{x e^{iax}}{b^2+x^2} dx + \int_0^{\pi} \frac{R e^{i\theta} e^{iaR e^{i\theta}}}{b^2+R^2 e^{2i\theta}} iR e^{i\theta} d\theta.$$

Writing $-x$ for x in the first integral, it becomes

$$\int_{\infty}^0 \frac{x e^{-iax}}{b^2+x^2} dx = -\int_0^{\infty} \frac{x e^{-iax}}{b^2+x^2} dx,$$

which combines with the second integral to give $\int_0^{\infty} \frac{2ix \sin ax}{b^2+x^2} dx$.

The third integral, as in the last case, contains the factor $e^{-aR \sin \theta}$ in the integrand, and therefore vanishes when R is ∞ , $\sin \theta$ being positive.

Hence, as the integral round the outer boundary is equal to that round the inner in the same sense,

$$\int_0^{\infty} \frac{x \sin ax}{b^2+x^2} dx = \frac{\pi}{2} e^{-ab}.$$

1309. Consider the integration of $w = \frac{e^{iaz}}{z(b^2+z^2)}$ for real and positive values of a and b .

There are poles at $z=0$ and $z = \pm ib$; and when $|z| = \infty$ the integrand vanishes.

Take the same contour as in the last two cases, with the addition of a small semicircle of radius ρ , with centre at the origin, to exclude the pole at $z=0$.

Integrate, as before, round the boundary $CDEFABC$, and equate to the integral round the small circle encircling $z=ib$ in the same sense.

Thus

$$\int_{-\infty}^{-\rho} \frac{e^{iax} dx}{x(b^2+x^2)} + \int_{\pi}^0 \frac{e^{i\rho e^{i\theta}} \rho e^{i\theta} d\theta}{\rho e^{i\theta} (b^2 + \rho^2 e^{2i\theta})} + \int_{\rho}^{\infty} \frac{e^{iax} dx}{x(b^2+x^2)} + \int_0^{\pi} \frac{e^{iaRe^{i\theta}} \rho e^{i\theta} d\theta}{Re^{i\theta} (b^2 + R^2 e^{2i\theta})}$$

$$= 2\pi i \frac{e^{ia(b)}}{2i^2 b^2} = -\frac{\pi i}{b^2} e^{-ab}.$$

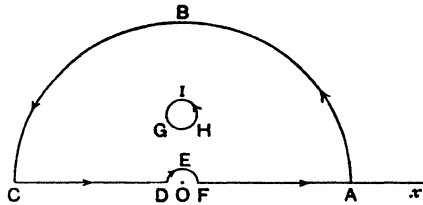

Fig. 410.

Then writing $-x$ for x in the first integral, it combines with the third to give $\int_0^{\infty} \frac{2i \sin ax}{x(b^2+x^2)}$.

Since ρ is infinitesimal the second integral $= \int_{\pi}^0 \frac{i}{b^2} d\theta = -\frac{\pi i}{b^2}$.

The fourth integral vanishes for the same reason as in the last two cases.

Hence
$$\int_0^{\infty} \frac{\sin ax}{x(b^2+x^2)} dx = \frac{\pi}{2b^2} (1 - e^{-ab}).$$

1310. Consider $\int \frac{e^{az}}{b^{2n} + z^{2n}} dz$, a and b being real and positive.

The poles are given by

$$z^{2n} + b^{2n} \equiv \prod_{s=0}^{s=n-1} (z^2 - 2bz \cos \frac{2s+1}{2n} \pi + b^2) = 0,$$

i.e.
$$z = b \left(\cos \frac{2s+1}{2n} \pi \pm i \sin \frac{2s+1}{2n} \pi \right) = be^{\pm i \frac{2s+1}{2n} \pi},$$

and lie upon a circle of radius b at equal angular intervals $\frac{\pi}{n}$, the x -axis being an axis of symmetry with regard to the poles and not passing through any of them. Also if $|z| = \infty$ the integrand ultimately vanishes.

We take the same contour as before, viz. an infinite semicircle of radius $R (= \infty)$ and centre at the z -origin O , the x -axis and infinitesimal circles of radius ρ drawn round each pole as centre.

Now
$$\frac{1}{z^{2n} + b^{2n}} = \sum_{s=0}^{s=n-1} \frac{1}{2n \left(be^{i \frac{2s+1}{2n} \pi} \right)^{2n-1} \left(z - be^{i \frac{2s+1}{2n} \pi} \right)}$$

$$+ \sum_{s=0}^{s=n-1} \frac{1}{2n \left(be^{-i \frac{2s+1}{2n} \pi} \right)^{2n-1} \left(z - be^{-i \frac{2s+1}{2n} \pi} \right)},$$

the poles of the second group lying outside the contour of integration, and therefore contributing nothing. The pole $z = be^{\frac{2s+1}{2n}\pi}$ contributes

$$2i\pi \frac{e^{iabe^{\frac{2s+1}{2n}\pi}}}{2n \left(be^{\frac{2s+1}{2n}\pi} \right)^{2n-1}}.$$

Hence the poles within the contour contribute in the aggregate

$$\sum_{s=0}^{n-1} \frac{i\pi}{n} \frac{e^{iabe^{\frac{2s+1}{2n}\pi}}}{\left(be^{\frac{2s+1}{2n}\pi} \right)^{2n-1}},$$

i.e. . . .
$$-\sum_0^{n-1} \frac{i\pi}{nb^{2n-1}} e^{i\frac{2s+1}{2n}\pi} e^{iabe^{\frac{2s+1}{2n}\pi}}$$

$$= -\sum_0^{n-1} \frac{i\pi}{nb^{2n-1}} e^{-ab \sin \frac{2s+1}{2n}\pi} \left[\cos \left(\frac{2s+1}{2n}\pi + ab \cos \frac{2s+1}{2n}\pi \right) + i \sin \left(\frac{2s+1}{2n}\pi + ab \cos \frac{2s+1}{2n}\pi \right) \right]. \quad (1)$$

For the outer contour we have

$$\int_{-\infty}^{\infty} \frac{e^{iaz}}{b^{2n} + x^{2n}} dx + \int_0^{\infty} \frac{e^{iaz}}{b^{2n} + x^{2n}} dx + \int_0^{\pi} \frac{e^{iaRe^{i\theta}} iRe^{i\theta} d\theta}{b^{2n} + R^{2n}e^{i2n\theta}}.$$

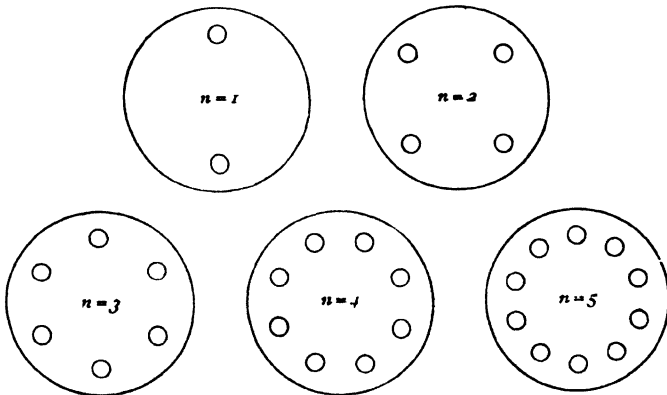

Fig. 411.

The first integral, by putting $-x$ for x , becomes $\int_0^{\infty} \frac{e^{-iaz}}{b^{2n} + x^{2n}} dx$, and combines with the second integral to make $\int_0^{\infty} \frac{2 \cos ax}{b^{2n} + x^{2n}} dx$.

The third integral vanishes when $R = \infty$, as it contains the vanishing factor $e^{-aR \sin \theta}$; and since the integral round the outer boundary of the

contour is equal to the sum of the integrals round the small circles which contain the poles which lie within the great semicircle,

$$\int_0^{\infty} \frac{\cos ax}{b^{2n} + x^{2n}} dx = \frac{\pi}{2n b^{2n-1}} \sum_0^{n-1} e^{-ab \sin \frac{2s+1}{2n} \pi} \sin \left[\frac{2s+1}{2n} \pi + ab \cos \left(\frac{2s+1}{2n} \pi \right) \right], \quad (2)$$

which is the result established in Art. 1067.

It will be noted that in the summation above in equation (1), that the imaginary portion vanishes, the poles being symmetrically situated about the y -axis.

The arrangement of the poles in the cases $n=1$, $n=2$, $n=3$, $n=4$, $n=5$, is shown in Fig. 411.

1311. Consider $w = \frac{\sinh az}{\sinh \pi z}$, a real, positive and $< \pi$.

Since the limit of this expression when $|z|=0$ is $\frac{a}{\pi}$, there will be no pole at the origin; and when $|z|=\infty$ the integrand ultimately becomes zero, since $a < \pi$.

Since $\sinh \pi z = \pi z \left(1 + \frac{z^2}{1^2}\right) \left(1 + \frac{z^2}{2^2}\right) \dots$, there are poles at $z = \pm i$, $z = \pm 2i$, $z = \pm 3i$, ..., which are all situated on the y -axis in the z -plane.

Take for the contour round which the integration $\int w dz$ is to be conducted:

- (1) the complete x -axis;
- (2) the ordinates $x = \pm R$, where R is infinitely great;
- (3) the portions CD ; FG of the line $y=1$ shown in Fig. 412;
- (4) the semicircular arc, convex to the origin, centre at $z=i$ and of infinitesimal radius ρ , viz. DEF as shown.

Then all poles are excluded from the region thus bounded, and the function is synectic in this region.

The contribution to the integral for the x -axis is $\int_{-\infty}^{\infty} \frac{\sinh ax}{\sinh \pi x} dx$ for $z=x$ and $dz=dx$; or, what is the same thing, $2 \int_0^{\infty} \frac{\sinh ax}{\sinh \pi x} dx$.

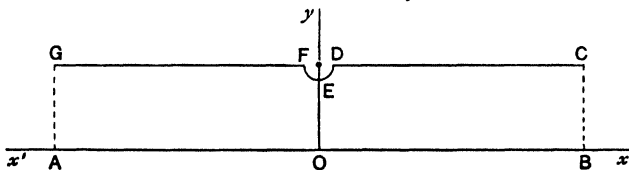

Fig. 412.

The ordinates BC , GA at infinity yield no contribution.

For, along BC , we have $\int_0^1 \frac{\sinh a(R+iy)}{\sinh \pi(R+iy)} i dy$,

and R being large, $\sinh aR$ and $\cosh aR$ may be written $\frac{1}{2}e^{aR}$, and $\sinh \pi R$ and $\cosh \pi R$ may be written $\frac{1}{2}e^{\pi R}$.

Hence the integration along BC reduces to $\int_0^1 \frac{e^{aR} e^{iay}}{e^{\pi R} e^{i\pi y}} i dy$, i.e.

$$\int_0^1 e^{(a-\pi)R} e^{(a-\pi)i y} i dy,$$

which vanishes by virtue of the zero factor $e^{(a-\pi)R}$ in the integrand, since $a - \pi$ is negative and R is infinite. Similarly for the portion GA .

For the portions CD and FG we have respectively

$$\int_{-\infty}^{\rho} \frac{\sinh a(\iota+x)}{\sinh \pi(\iota+x)} dx \quad \text{and} \quad \int_{-\rho}^{-\infty} \frac{\sinh a(\iota+x)}{\sinh \pi(\iota+x)} dx.$$

Considering the first of these integrals,

$$\begin{aligned} \sinh a(\iota+x) &= \iota \sin a \cosh ax + \cos a \sinh ax, \\ \sinh \pi(\iota+x) &= \sinh \pi x; \end{aligned}$$

\therefore the integral becomes $\int_{-\rho}^{\infty} \frac{\iota \sin a \cosh ax + \cos a \sinh ax}{\sinh \pi x} dx$;

and writing $-x$ for x in the second integral, it becomes

$$-\int_{\rho}^{-\infty} \frac{\sinh a(\iota-x)}{\sinh \pi(\iota-x)} dx = -\int_{\rho}^{\infty} \frac{\iota \sin a \cosh ax - \cos a \sinh ax}{\sinh \pi x} dx,$$

and CD, FG together yield $2 \cos a \int_{\rho}^{\infty} \frac{\sinh ax}{\sinh \pi x} dx$.

To consider the contribution of the infinitesimal semicircle DEF , put $z = \iota + \rho e^{i\theta}$, and integrate from $\theta = 0$ to $\theta = -\pi$.

$$\begin{aligned} \text{Thus} \quad \sinh az &= \sinh a(\iota + \rho e^{i\theta}) = \iota \sin a, \rho \text{ being infinitesimal,} \\ \sinh \pi z &= \sinh \pi(\iota + \rho e^{i\theta}) = \pi \rho e^{i\theta} \cosh \pi \iota = -\pi \rho e^{i\theta}. \end{aligned}$$

The yield from this part is therefore

$$-\int_0^{-\pi} \frac{\iota \sin a}{\pi \rho e^{i\theta}} (\rho e^{i\theta} i d\theta) = \frac{\sin a}{\pi} \int_0^{-\pi} d\theta = -\sin a.$$

Hence, as the total integral round the contour vanishes,

$$2 \int_0^{\infty} \frac{\sinh ax}{\sinh \pi x} dx + 0 + 2 \cos a \int_{\rho}^{\infty} \frac{\sinh ax}{\sinh \pi x} dx + (-\sin a) = 0;$$

and ρ being ultimately zero,

$$\int_0^{\infty} \frac{\sinh ax}{\sinh \pi x} dx = \frac{1}{2} \tan \frac{a}{2}, \quad \text{and} \quad \int_{-\infty}^{\infty} \frac{\sinh ax}{\sinh \pi x} dx = \tan \frac{a}{2}.$$

1312. Now take $w = \frac{\cosh az}{\cosh \pi z}$, a being real, positive and $< \pi$.

Since $\cosh \pi z = (1 + 4z^2) \left(1 + \frac{4z^2}{3^2}\right) \left(1 + \frac{4z^2}{5^2}\right) \dots$, the poles of w are at

$$z = \pm \frac{\iota}{2}, \quad \pm \frac{3\iota}{2}, \quad \pm \frac{5\iota}{2}, \quad \text{etc.}$$

If we take a contour consisting of the x -axis and a parallel, $y = \frac{1}{2}$, with bounding ordinates $x = \pm R$ at infinity, and a small semicircle, convex to the origin and radius ρ , described about $z = \frac{\iota}{2}$; the region thus defined

excludes the poles, and w is a synectic within it, so that $\int w dz = 0$ when the integration is conducted along the contour of this region.

The points B, C , shown in the figure, are supposed at ∞ , and A, G at $-\infty$, and DEF is the infinitesimal semicircle about $z = \frac{i}{2}$ (Fig. 413).

The x -axis contributes $\int_{-\infty}^{\infty} \frac{\cosh ax}{\cosh \pi x} dx$, that is, $2 \int_0^{\infty} \frac{\cosh ax}{\cosh \pi x} dx$.

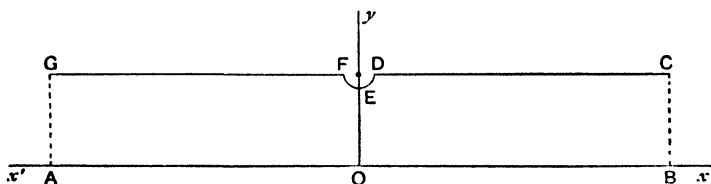

Fig. 413.

The ordinates at infinity contribute

$$\int_0^{\frac{1}{2}} \frac{\cosh a(R+iy)}{\cosh \pi(R+iy)} i dy \quad \text{and} \quad \int_{\frac{1}{2}}^0 \frac{\cosh a(-R+iy)}{\cosh \pi(-R+iy)} i dy;$$

and, as in the former case,

$$\cosh aR, \quad \sinh aR, \quad \cosh \pi R, \quad \sinh \pi R$$

may be replaced by $\frac{1}{2}e^{aR}$, $\frac{1}{2}e^{aR}$, $\frac{1}{2}e^{\pi R}$, $\frac{1}{2}e^{\pi R}$, respectively, since R is infinitely large; and we may write

$$\cosh a(R+iy) = \frac{1}{2}e^{aR} e^{iaiy}, \quad \cosh \pi(R+iy) = \frac{1}{2}e^{\pi R} e^{i\pi iy},$$

$$\cosh a(-R+iy) = \frac{1}{2}e^{aR} e^{-iaiy} \quad \text{and} \quad \cosh \pi(-R+iy) = \frac{1}{2}e^{\pi R} e^{-i\pi iy};$$

and the two integrals become

$$\int_0^{\frac{1}{2}} e^{(a-\pi)R} e^{i(a-\pi)y} i dy \quad \text{and} \quad - \int_0^{\frac{1}{2}} e^{(a-\pi)R} e^{-i(a-\pi)y} i dy,$$

which both vanish when R is infinite by virtue of the ultimately zero factor $e^{(a-\pi)R}$ in the integrands, a being $< \pi$. Hence the yield from the two ordinates is nil.

The parts CD and FG respectively contribute

$$\int_{\infty}^{\rho} \frac{\cosh a\left(x + \frac{i}{2}\right)}{\cosh \pi\left(x + \frac{i}{2}\right)} dx \quad \text{and} \quad \int_{-\rho}^{-\infty} \frac{\cosh a\left(x + \frac{i}{2}\right)}{\cosh \pi\left(x + \frac{i}{2}\right)} dx,$$

and
$$\cosh a\left(x + \frac{i}{2}\right) = \cosh ax \cos \frac{a}{2} + i \sinh ax \sin \frac{a}{2},$$

$$\cosh \pi\left(x + \frac{i}{2}\right) = i \sinh \pi x,$$

and the first integral becomes
$$- \int_{\rho}^{\infty} \frac{\cosh ax \cos \frac{a}{2} + i \sinh ax \sin \frac{a}{2}}{i \sinh \pi x} dx;$$

and similarly writing $-x$ for x in the second integral, it becomes

$$-\int_{\rho}^{\infty} \frac{\cosh a\left(\frac{\iota}{2}-x\right)}{\cosh \pi\left(\frac{\iota}{2}-x\right)} dx = \int_{\rho}^{\infty} \frac{\cosh ax \cos \frac{a}{2} - \iota \sinh ax \sin \frac{a}{2}}{\iota \sinh \pi x} dx.$$

Hence, in the aggregate, these two terms yield $-2 \sin \frac{a}{2} \int_{\rho}^{\infty} \frac{\sinh ax}{\sinh \pi x} dx$.

To find what accrues from the semicircle DEF , we put $z = \frac{\iota}{2} + \rho e^{\iota\theta}$, and integrate with regard to θ from $\theta = 0$ to $\theta = -\pi$.

Thus, since $\cosh a\left(\frac{\iota}{2} + \rho e^{\iota\theta}\right) = \cos \frac{a}{2}$ to the first term, ρ being infinitesimal, and $\cosh \pi\left(\frac{\iota}{2} + \rho e^{\iota\theta}\right) = \pi \rho \iota e^{\iota\theta}$,

$$\int \frac{\cosh az}{\cosh \pi z} dz \text{ round the semicircle} = \int_0^{-\pi} \frac{\cos \frac{a}{2}}{\pi \rho \iota e^{\iota\theta}} \iota \rho e^{\iota\theta} d\theta = -\cos \frac{a}{2},$$

and the total integral round the contour $= 0$, since w is synectic throughout the region bounded; hence

$$2 \int_0^{\infty} \frac{\cosh ax}{\cosh \pi x} dx + 0 - 2 \sin \frac{a}{2} \int_{\rho}^{\infty} \frac{\sinh ax}{\sinh \pi x} dx - \cos \frac{a}{2} = 0;$$

and ρ being ultimately zero,

$$2 \int_0^{\infty} \frac{\cosh ax}{\cosh \pi x} dx = \cos \frac{a}{2} + 2 \sin \frac{a}{2} \cdot \frac{1}{2} \tan \frac{a}{2} = \sec \frac{a}{2};$$

and therefore $\int_0^{\infty} \frac{\cosh ax}{\cosh \pi x} dx = \frac{1}{2} \sec \frac{a}{2}$, and $\int_{-\infty}^{\infty} \frac{\cosh ax}{\cosh \pi x} dx = \sec \frac{a}{2}$.

1313. Consider $w = \frac{e^{aiz}}{\cosh \pi z}$, where a is a complex constant $= a + \iota\beta$, in which β is not negative.

The poles are, as before, $z = \frac{\iota}{2}, \frac{3\iota}{2}, \frac{5\iota}{2}$, etc., and in addition, since

$$e^{\iota(\alpha + \iota\beta)(x + \iota y)} = e^{-\beta x - \alpha y} e^{\iota(\alpha x - \beta y)},$$

the function becomes infinite if $\beta x + \alpha y = -\infty$. Hence we must take a contour which excludes all such points.

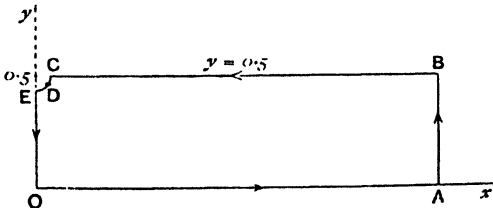

Fig. 414.

The region bounded by the positive direction of the x -axis, an ordinate $x = R$ where $R = \infty$, the straight line $y = \frac{1}{2}$, the quadrant of a circle of

centre $z = \frac{\iota}{2}$ and infinitesimal radius ρ , viz. CDE and the portion EO of the y -axis, contains no pole and the function w is synectic throughout it (Fig. 414).

The x -axis contributes
$$\int_0^{\infty} \frac{e^{-\beta x} e^{i\alpha x}}{\cosh \pi x} dx$$

The ordinate AB at infinity contributes nothing, for the integrand contains the factor $e^{-\beta x}$, which vanishes when $x = \sigma$.

The path $y = \frac{1}{2}$ from $x = R$ to $x = \rho$ contributes

$$\int_{\rho}^R \frac{e^{-\frac{\alpha}{2}x} e^{-\beta x} e^{i\left(\frac{\alpha x - \beta}{2}\right)}}{\iota \sinh \pi x} dx, \text{ for } \cosh \pi \left(\frac{\iota}{2} + x\right) = \iota \sinh \pi x.$$

For the infinitesimal quadrantal arc with centre $\frac{\iota}{2}$, put $z = \frac{\iota}{2} + \rho e^{i\theta}$ and integrate from $\theta = 0$ to $\theta = -\frac{\pi}{2}$.

This yields
$$\int_0^{-\frac{\pi}{2}} \frac{e^{i(\alpha + i\beta)\left(\frac{\iota}{2} + \rho e^{i\theta}\right)}}{\cosh \pi \left(\frac{\iota}{2} + \rho e^{i\theta}\right)} \iota \rho e^{i\theta} d\theta,$$

i.e. ρ being infinitesimal,

$$\int_0^{-\frac{\pi}{2}} \frac{e^{-\frac{1}{2}(\alpha + i\beta)}}{\pi} d\theta = -\frac{1}{2} e^{-\frac{1}{2}(\alpha + i\beta)}.$$

The portion EO of the y -axis contributes

$$\int_{\frac{1}{2} - \rho}^0 \frac{\rho^{-\alpha y} e^{-i\beta y}}{\cosh i\pi y} \iota dy = -\iota \int_0^{\frac{1}{2} - \rho} \frac{e^{-\alpha x} e^{-i\beta x}}{\cos \pi x} dx$$

Hence, as the total integral $\int w dz$ vanishes,

$$\begin{aligned} \int_0^{\infty} \frac{e^{-\beta x} (\cos \alpha x + \iota \sin \alpha x)}{\cosh \pi x} dx &= \int_0^{\infty} \frac{e^{-\frac{\alpha}{2}x} e^{-\beta x} \left[\cos \left(\alpha x - \frac{\beta}{2} \right) + \iota \sin \left(\alpha x - \frac{\beta}{2} \right) \right]}{\iota \sinh \pi x} dx, \\ &= \frac{1}{2} e^{-\frac{\alpha}{2}} \left(\cos \frac{\beta}{2} - \iota \sin \frac{\beta}{2} \right) - \iota \int_0^{\frac{1}{2} - \rho} \frac{e^{-\alpha x} \cos \beta x - \iota \sin \beta x}{\cos \pi x} dx = 0. \end{aligned}$$

Hence, equating to zero the real and imaginary parts and proceeding to the limit when $\rho = 0$,

$$\int_0^{\infty} e^{-\beta x} \frac{\cos \alpha x}{\cosh \pi x} dx - e^{-\frac{\alpha}{2}} \int_0^{\infty} e^{-\beta x} \frac{\sin \left(\alpha x - \frac{\beta}{2} \right)}{\sinh \pi x} dx - \int_0^{\frac{1}{2}} \frac{e^{-\alpha x} \sin \beta x}{\cos \pi x} dx = \frac{1}{2} e^{-\frac{\alpha}{2}} \cos \frac{\beta}{2},$$

$$\int_0^{\infty} e^{-\beta x} \frac{\sin \alpha x}{\cosh \pi x} dx + e^{-\frac{\alpha}{2}} \int_0^{\infty} e^{-\beta x} \frac{\cos \left(\alpha x - \frac{\beta}{2} \right)}{\sinh \pi x} dx - \int_0^{\frac{1}{2}} \frac{e^{-\alpha x} \cos \beta x}{\cos \pi x} dx = -\frac{1}{2} e^{-\frac{\alpha}{2}} \sin \frac{\beta}{2}.$$

If we put $\beta=0$ in the first, we have

$$\int_0^{\infty} \frac{\cos ax}{\cosh \pi x} dx - e^{-\frac{\alpha}{2}} \int_0^{\infty} \frac{\sin ax}{\sinh \pi x} dx = \frac{1}{2} e^{-\frac{\alpha}{2}},$$

and changing the sign of a ,

$$\int_0^{\infty} \frac{\cos ax}{\cosh \pi x} dx + e^{\frac{\alpha}{2}} \int_0^{\infty} \frac{\sin ax}{\sinh \pi x} dx = \frac{1}{2} e^{\frac{\alpha}{2}},$$

and solving these equations,

$$\int_0^{\infty} \frac{\cos ax}{\cosh \pi x} dx = \frac{1}{2} \operatorname{sech} \frac{\alpha}{2}, \quad \int_0^{\infty} \frac{\sin ax}{\sinh \pi x} dx = \frac{1}{2} \tanh \frac{\alpha}{2}.$$

1314. Consider $w = z^p - 2az \cos a + a^2$, where $1 > p > 0$, a real and $\pi > a > 0$.

There are poles at $z = ae^{i\alpha} = a \cos a + ia \sin a$. Take as contour an infinite semicircle, radius R ($\rightarrow \infty$) and centre at the origin (O); the x -axis; and a small circle, radius ρ and centre at $z = ae^{i\alpha}$, i.e. ($a \cos a, a \sin a$) (Fig. 105).

The contribution from integrating along the x -axis is

$$\int_{-\infty}^{\infty} \frac{x^p}{x^2 - 2ax \cos a + a^2} dx - \left(\int_{-\pi}^0 + \int_0^{\pi} \right) \frac{x^p}{x^2 - 2ax \cos a + a^2} dx;$$

and putting $x = r$ for x in the first integral,

$$\int_0^{\infty} \frac{r^p}{r^2 - 2ar \cos a + a^2} dr + \int_0^{\infty} \frac{(-1)^p r^p}{r^2 + 2ar \cos a + a^2} dx.$$

Round the infinite semicircle we have

$$\int_0^{\pi} \frac{R^p e^{i p \theta}}{R^2 e^{2i\theta} - 2a R e^{i\theta} \cos a + a^2} R e^{i\theta} \cdot i d\theta,$$

which vanishes, since $p < 1$

For the infinitesimal circle put $z = ae^{i\alpha} + \rho e^{i\theta}$. The result is, by Art. 1286

$$2\pi i \frac{(ae^{i\alpha} + \rho e^{i\theta})^p}{ae^{i\alpha} + \rho e^{i\theta} - ae^{-i\alpha}};$$

and ρ being infinitesimal, this becomes

$$2\pi i \frac{a^p e^{i p \alpha}}{a(e^{i\alpha} - e^{-i\alpha})} = \frac{\pi}{\sin a} a^{p-1} e^{i p \alpha};$$

and since the integral round the outer contour is equal to that round the inner in the same sense,

$$\int_0^{\infty} \frac{x^p}{x^2 - 2ax \cos a + a^2} dx + e^{i p \pi} \int_0^{\infty} \frac{x^p}{x^2 + 2ax \cos a + a^2} dx = \frac{\pi}{\sin a} a^{p-1} e^{i p \alpha},$$

and equating real and imaginary parts,

$$\int_0^{\infty} \frac{x^p dx}{x^2 - 2ax \cos a + a^2} + \cos p\pi \int_0^{\infty} \frac{x^p dx}{x^2 + 2ax \cos a + a^2} = \frac{\pi}{\sin a} a^{p-1} \cos p\alpha,$$

$$\sin p\pi \int_0^{\infty} \frac{x^p dx}{x^2 + 2ax \cos a + a^2} = \frac{\pi}{\sin a} a^{p-1} \sin p\alpha.$$

Hence

$$\left. \begin{aligned} \int_0^{\infty} \frac{x^p dx}{x^2 + 2ax \cos a + a^2} &= \frac{\pi}{\sin a} a^{p-1} \frac{\sin pa}{\sin p\pi}, \\ \int_0^{\infty} \frac{x^p dx}{x^2 - 2ax \cos a + a^2} &= \frac{\pi}{\sin a} a^{p-1} \frac{\sin p(\pi - a)}{\sin p\pi}, \end{aligned} \right\} \begin{aligned} 1 > p > 0, \\ \pi > a > 0, \end{aligned}$$

the latter of which follows also from the former by writing $\pi - a$ for a .

1315. Consider $w = \frac{e^{iaz}}{\cosh z - \cos b}$, where a and b are real. ($0 < b < \pi$.)

The poles are given by $\cosh z = \cos b$, that is

$$e^{2z} - 2 \cos b e^z + 1 = 0, \quad e^z = \cos b \pm i \sin b, \quad z = i(2n\pi \pm b),$$

where n is any integer.

These poles are all situated upon the y -axis at distances from the origin $\pm b, \pm 2\pi \pm b$, etc.

Take as contour the entire x -axis, the ordinates $x = \pm R$ ($R = \infty$), the straight line $y = \pi$, and an infinitesimal circle, radius ρ and centre $z = ib$. Then the function w is synectic in the region thus bounded, the only pole ($z = ib$) which lies within the outer boundary being excluded by the inner.

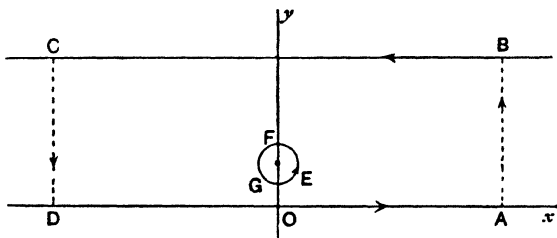

Fig. 415.

The contributions from the various parts are :

(1) From the x axis DA , $\int_{-\infty}^{\infty} \frac{e^{iaz}}{\cosh x - \cos b} dx$.

(2) From the ordinate AB ,

$$\int_0^{\pi} \frac{e^{i a(R+iy)}}{e^{R+iy} + e^{-R-iy} - \cos b} i dy = 2i \int_0^{\pi} \frac{e^{-ay} (\cos aR + i \sin aR)}{e^{R+iy} + e^{-R-iy} - 2 \cos b} dy = 0,$$

where $R = \infty$; therefore AB contributes nothing. Similarly CD gives no contribution.

(3) From BC , viz. $y = \pi$, we have

$$z = x + i\pi, \quad dz = dx, \quad \cosh z = -\cosh x \quad \text{and} \quad e^{iaz} = e^{-\pi a} \cdot e^{iax}.$$

Hence BC renders

$$\int_{-\infty}^{\infty} \frac{e^{-\pi a} e^{iax}}{-\cosh x - \cos b} dx = e^{-\pi a} \int_{-\infty}^{\infty} \frac{e^{iax}}{\cosh x + \cos b} dx.$$

(4) The integration round the small circle gives

$$2\pi i \frac{e^{i a(i b)}}{\sinh i b}, \quad \text{i.e. } 2\pi \frac{e^{-ab}}{\sin b},$$

and the integration round the outer contour is equal to that round the small circle in the same sense. Hence

$$\int_{-\infty}^{\infty} \frac{e^{ax} dx}{\cosh x - \cos b} + e^{-\pi a} \int_{-\infty}^{\infty} \frac{e^{ax} dx}{\cosh x + \cos b} = \frac{2\pi}{\sin b} e^{-ab}.$$

Let $I_1 = \int_{-\infty}^{\infty} \frac{\cos ax}{\cosh x - \cos b} dx, \quad I_2 = \int_{-\infty}^{\infty} \frac{\sin ax}{\cosh x - \cos b} dx,$

$$I_1' = \int_{-\infty}^{\infty} \frac{\cos ax}{\cosh x + \cos b} dx, \quad I_2' = \int_{-\infty}^{\infty} \frac{\sin ax}{\cosh x + \cos b} dx.$$

Then $I_1 + i I_2 + e^{-\pi a} (I_1' + i I_2') = \frac{2\pi}{\sin b} e^{-ab},$

and therefore $I_1 + e^{-\pi a} I_1' = \frac{2\pi}{\sin b} e^{-ab}$ and $I_2 + e^{-\pi a} I_2' = 0.$

Also, if we write $\pi - b$ for b , the accented and unaccented letters are interchanged. Hence

$$I_1' + e^{-\pi a} I_1 = \frac{2\pi}{\sin b} e^{-a(\pi - b)} \quad \text{and} \quad I_2' + e^{-\pi a} I_2 = 0;$$

and solving these four equations,

$$I_1 \equiv \int_{-\infty}^{\infty} \frac{\cos ax}{\cosh x - \cos b} dx = \frac{2\pi}{\sin b} \frac{\sinh a(\pi - b)}{\sinh a\pi}, \quad \dots\dots\dots(1)$$

$$I_1' \equiv \int_{-\infty}^{\infty} \frac{\cos ax}{\cosh x + \cos b} dx = \frac{2\pi}{\sin b} \frac{\sinh ab}{\sinh a\pi}, \quad \dots\dots\dots(2)$$

and $I_2 = I_2' = 0$, as is indeed obvious beforehand, since, in integrating from $-\infty$ to ∞ elements of the integrands for which x only differs in sign cancel each other.

Obviously other results may be deduced from these by various selections of a and b , combined with addition or subtraction of the results.

For instance, in the formulae for I_1 and I_1' , the integrands are not affected if the sign of x be changed, so that

$$\int_0^{\infty} \frac{\cos ax}{\cosh x - \cos b} dx = \frac{\pi}{\sin b} \frac{\sinh a(\pi - b)}{\sinh a\pi}, \quad \dots\dots\dots(3)$$

$$\int_0^{\infty} \frac{\cos ax}{\cosh x + \cos b} dx = \frac{\pi}{\sin b} \frac{\sinh ab}{\sinh a\pi}. \quad \dots\dots\dots(4)$$

Changing b to $\frac{\pi}{2} - b$ in (3) and (4),

$$\int_0^{\infty} \frac{\cos ax}{\cosh x - \sin b} dx = \frac{\pi}{\cos b} \frac{\sinh a\left(\frac{\pi}{2} + b\right)}{\sinh a\pi}, \quad \dots\dots\dots(5)$$

$$\int_0^{\infty} \frac{\cos ax}{\cosh x + \sin b} dx = \frac{\pi}{\cos b} \frac{\sinh a\left(\frac{\pi}{2} - b\right)}{\sinh a\pi}. \quad \dots\dots\dots(6)$$

Putting $a=1$ in (3) and (4),

$$\int_0^\infty \frac{\cos x}{\cosh x - \cos b} dx = \frac{\pi}{\sin b} \frac{\sinh(\pi - b)}{\sinh \pi}, \dots\dots\dots(7)$$

$$\int_0^\infty \frac{\cos x}{\cosh x + \cos b} dx = \frac{\pi}{\sin b} \frac{\sinh b}{\sinh \pi}. \dots\dots\dots(8)$$

Adding (3) and (4),

$$\begin{aligned} \int_0^\infty \frac{\cos ax \cosh x}{\cosh 2x - \cos 2b} dx &= \frac{\pi}{4 \sin b} \frac{\sinh a(\pi - b) + \sinh ab}{\sinh a\pi} \\ &= \frac{\pi}{4 \sin b} \frac{\cosh a\left(\frac{\pi}{2} - b\right)}{\cosh \frac{a\pi}{2}}. \dots\dots\dots(9) \end{aligned}$$

Subtracting (4) from (3),

$$\int_0^\infty \frac{\cos ax}{\cosh 2x - \cos 2b} dx = \frac{\pi}{2 \sin 2b} \frac{\sinh a\left(\frac{\pi}{2} - b\right)}{\sinh \frac{a\pi}{2}}. \dots\dots\dots(10)$$

Writing $\frac{\pi}{2} - b$ for b in (9) and (10),

$$\int_0^\infty \frac{\cos ax \cosh x}{\cosh 2x + \cos 2b} dx = \frac{\pi}{4 \cos b} \frac{\cosh ab}{\cosh \frac{a\pi}{2}}, \dots\dots\dots(11)$$

$$\int_0^\infty \frac{\cos ax}{\cosh 2x + \cos 2b} dx = \frac{\pi}{2 \sin 2b} \frac{\sinh ab}{\sinh \frac{a\pi}{2}}, \dots\dots\dots(12)$$

and so on with other cases.

1316. Consider $w = \frac{e^{az}}{1 - e^z}$, a being real and $1 > a > 0$.

Here there are poles wherever $e^z = 1$, i.e. $z = \log(e^{2i\lambda\pi}) = 2i\lambda\pi$ for any integral value of λ .

Take as contour a rectangle of infinite length, one side along the x -axis and extending from $x = -x$ to $x = x$; two ordinates, one at x , one at $-x$; the line $y = \pi$ and an infinitesimal semicircle excluding the origin. Then, integrating round this contour, no pole being in the region surrounded, we have, with the notation of preceding cases,

$$\begin{aligned} \int_{-\infty}^{-\rho} \frac{e^{ax}}{1 - e^x} dx + \int_{\pi}^{\rho} \frac{e^{a\rho e^{i\theta}}}{1 - e^{\rho e^{i\theta}}} i\rho e^{i\theta} d\theta + \int_{\rho}^x \frac{e^{ax}}{1 - e^x} dx + \int_0^{\pi} \frac{e^{a(R+i y)}}{1 - e^{(R+i y)}} i dy \\ + \int_x^{-\infty} \frac{e^{a(x+i\pi)}}{1 - e^{(x+i\pi)}} dx + \int_{\pi}^0 \frac{e^{a(-R+i y)}}{1 - e^{(-R+i y)}} i dy = 0. \end{aligned}$$

In the limit, when ρ is indefinitely small and R infinitely great, the first and third integrals together give the Principal Value of $\int_{-\infty}^{\infty} \frac{e^{ax}}{1 - e^x} dx$

The second integral = $\int_0^{\pi} (-i) d\theta$ when ρ becomes indefinitely small, = $i\pi$.

The fourth vanishes, since it is ultimately

$$-Ll_{R \rightarrow \infty} \int_0^\pi e^{(a-1)(R+iy)t} dy \quad \text{and} \quad a < 1.$$

The fifth integral $= \int_{-\infty}^{\infty} \frac{(\cos a\pi + i \sin a\pi)e^{ax}}{1+e^x} dx.$

The sixth integral ultimately vanishes when R increases without limit.

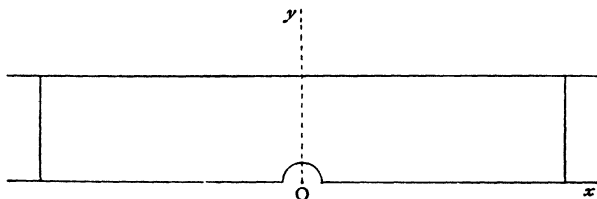

Fig. 416

Thus, Prin. Val. of $\int_{-\infty}^{\infty} \frac{e^{ax}}{1+e^x} dx + (\cos a\pi + i \sin a\pi) \int_{\infty}^{-\infty} \frac{e^{ax}}{1+e^x} dx + i\pi = 0.$

Hence $\int_{-\infty}^{\infty} \frac{e^{ax}}{1+e^x} dx = \pi \operatorname{cosec} a\pi,$

and the Principal Value of

$$\int_{-\infty}^{\infty} \frac{e^{ax}}{1-e^x} dx = \pi \cot a\pi.$$

This result is, however, only a transformation of that of Art. 1306.

1317. Effect of Pole-Clusters within a Contour.

If several poles, say n , be clustered together at one point of the z -plane, the point is said to be a pole of multiplicity n , or to possess polarity of the n^{th} order at the point $z = a$.

It is useful to note that in applying the theorem

$$\phi^{(n-1)}(a) = \frac{(n-1)!}{2\pi i} \int \frac{\phi(z)}{(z-a)^n} dz$$

to the case in which

$$w \equiv f(z) = \frac{\phi(z)}{(z-a)^n} = \frac{1}{(z-a)^n},$$

where n is a positive integer, we have $\phi(z) = 1$, and all its differential coefficients with regard to z are zero.

Hence $\int \frac{dz}{(z-a)^n}$ round the multiple pole $z = a$ is zero for all positive integral values of n except $n = 1$, and when $n = 1$ we have

$$\int \frac{dz}{z-a} = 2\pi i.$$

It follows that if w be of the form

$$\frac{\phi(z)}{(z-a)^p(z-b)^q(z-c)^r\dots},$$

where $\phi(z)$ does not contain any of the factors $z-a$, $z-b$, $z-c$, ..., but is rational and algebraic, there is polarity of order p , q , r , etc., at the respective points $z=a$, $z=b$, $z=c$, etc., and in putting w into partial fractions to prepare for integration round closed infinitesimal contours surrounding these poles it will only be necessary to retain those partial fractions in which $z-a$, $z-b$, etc., occur to the first power.

And supposing that the result of putting into partial fractions is

$$w = K_n z^n + K_{n-1} z^{n-1} + \dots + K_1 z + K_0 + \frac{A}{z-a} + \frac{B}{z-b} + \frac{C}{z-c} + \dots \\ + \sum_{r=2}^{r=p} \frac{A'}{(z-a)^r} + \sum_{r=2}^{r=q} \frac{B'}{(z-b)^r} + \dots,$$

then, in integrating round any closed contour which encloses all these critical points and no others,

$$\int w dz = 2\pi i (A + B + C + \dots).$$

1318. Moreover, when the numerator of w , supposed rational and algebraic, is of degree in z at least two lower than the degree of the denominator, $A + B + C + \dots = 0$ (Art. 149), and therefore in such cases $\int w dz = 0$, however many critical points may be enclosed within the contour, and whatever the degree of their polarity, provided the contour of integration contains all the poles.

It is worth notice that if

a_1, a_2, a_3, \dots be the zeros, of multiplicity p, q, r , etc.,
and a'_1, a'_2, a'_3, \dots be the poles, of multiplicity p'_1, q'_1, r'_1 , etc.,
of a function $f(z)$, so that

$$f(z) = \frac{(z-a_1)^p (z-a_2)^q (z-a_3)^r \dots}{(z-a'_1)^{p'} (z-a'_2)^{q'} (z-a'_3)^{r'} \dots},$$

we have

$$\frac{f'(z)}{f(z)} = \sum \frac{p}{z-a_1} - \sum \frac{p'}{z-a'_1};$$

whence, if $\phi(z)$ be any other function of z which has none of the factors $z-a_1', z-a_2', \text{ etc.}$, then

$$\frac{1}{2\pi i} \int \phi(z) \frac{f'(z)}{f(z)} dz = [\Sigma p\phi(a_1) - \Sigma p'\phi(a_1')],$$

the integral being taken round a contour which contains all the poles without passing through any of them;

or if $\phi(z)$ be unity, $\frac{1}{2\pi i} \int \frac{f'(z)}{f(z)} dz = (\Sigma p - \Sigma p')$.

1319. If, for instance,

$$f(z) = (z-a_1)^p (z-a_2)^q (z-a_3)^r \dots,$$

$$\frac{f'(z)}{f(z)} = \frac{p}{z-a_1} + \frac{q}{z-a_2} + \frac{r}{z-a_3} + \dots;$$

and if we integrate round any contour which contains some or all of the roots,

$$\frac{1}{2\pi i} \int \frac{f'(z)}{f(z)} dz = \frac{1}{2\pi i} \left[p \int \frac{dz}{z-a_1} + q \int \frac{dz}{z-a_2} + \dots \right],$$

for all the roots within the contour

$$= p + q + \dots$$

= the number of roots within the contour,

counting each root as many times over as it occurs in $f(z)$.

1320. Again, if in integrating round the perimeter of a closed curve which possesses no singularities and lies entirely in a region of the z -plane in which w is a synectic function, then if w be constant along the boundary of this curve it is constant for all points lying in the region thus bounded; for if $z=\xi$ be any point of this bounded region, then if $f(\xi)$ be the value of w at the point ξ , then

$$f(\xi) = \frac{1}{2\pi i} \int \frac{f(z)}{z-\xi} dz,$$

where z is a point on the boundary; and if $f(z) = \text{const.} = A$, say, at all points of the boundary,

$$f(\xi) = \frac{1}{2\pi i} \int \frac{A}{z-\xi} dz = \frac{1}{2\pi i} \cdot A \cdot 2\pi i = A,$$

for ξ is a pole of the function $\frac{f(z)}{z-\xi}$.

Hence, for all points ζ which lie within the boundary, the function $w \equiv f(\zeta)$ has the same value as when ζ lies on the boundary.

1321. Further, if we are given the value of w at all points of the contour of a region within which w is to be assumed synectic, the equation

$$f(\zeta) = \frac{1}{2\pi i} \int \frac{f(z)}{z - \zeta} d\zeta$$

may be used to find the value of $f(\zeta)$ at all points within the contour. For if $f(z)$ takes the form $\chi(z)$ at the boundary, the value of $f(\zeta)$ for a point within the boundary is

$$\frac{1}{2\pi i} \int \frac{\chi(z)}{z - \zeta} dz.$$

1322. Ex. Supposing that at all points of the circular contour $r=1$ a certain function known to be synectic within the circle takes the value $\cos 3\theta - a^2 \cos \theta + i(\sin 3\theta - a^2 \sin \theta)$, what is the function?

Putting this into the form $e^{3i\theta} - a^2 e^{i\theta}$, and writing $z = e^{i\theta}$, $d\zeta = ie^{i\theta} d\theta$,

$$\begin{aligned} f(\zeta) &= \frac{1}{2\pi i} \int_0^{2\pi} \frac{e^{3i\theta} - a^2 e^{i\theta}}{e^{i\theta} - \zeta} ie^{i\theta} d\theta \\ &= \frac{1}{2\pi i} \int_0^{2\pi} \left[e^{2i\theta} + \zeta e^{i\theta} + \zeta^2 - a^2 + \frac{\zeta(\zeta^2 - a^2)}{e^{i\theta} - \zeta} \right] ie^{i\theta} d\theta \\ &= \frac{1}{2\pi i} \left[\frac{e^{3i\theta}}{3} + \zeta \frac{e^{2i\theta}}{2} + (\zeta^2 - a^2) e^{i\theta} + \zeta(\zeta^2 - a^2) \log(e^{i\theta} - a^2) \right]_{0}^{2\pi} \\ &= \frac{1}{2\pi i} \zeta(\zeta^2 - a^2) \log 1, \end{aligned}$$

and $\log 1$ being $\log e^{2\lambda\pi i}$, where λ is an integer, we have $f(z) = \lambda \zeta(\zeta^2 - a^2)$, where the proper integral value of λ is to be chosen; and putting $\zeta = e^{i\theta}$, we have the contour value $\lambda(e^{3i\theta} - a^2 e^{i\theta})$. Hence $\lambda = 1$ and $f(z) = z(z^2 - a^2)$ for any point z within the contour $r = 1$.

1323. (1) Consider $w = \frac{e^{iaz}}{z^n}$, n being greater than 0 and less than 1, and a real and positive.

Here there is a pole at $z=0$. We may avoid this pole by taking a contour consisting of the portion of the x -axis from $x=\rho$ to $x=R$, a quadrant with centre at the origin and radius R ; the portion of the y -axis from $y=R$ to $y=\rho$, and a quadrant with centre at the origin and radius ρ . And we shall choose R to be ∞ and ρ to be infinitesimal. Then w is synectic in the region thus bounded, and we have

$$\int_{\rho}^R \frac{e^{iaz}}{z^n} dz + \int_0^{\frac{\pi}{2}} \frac{e^{iaRe^{i\theta}}}{(Re^{i\theta})^{n-1}} i d\theta + \int_R^{\rho} \frac{e^{-ay}}{(iy)^n} i dy + \int_{\frac{\pi}{2}}^0 \frac{e^{ia\rho e^{i\theta}}}{(\rho e^{i\theta})^{n-1}} i d\theta = 0.$$

The second integral contains the factor $\frac{e^{-aR \sin \theta}}{R^{n-1}}$, in which $\sin \theta$ is positive, and vanishes when R is infinite.

The fourth integral vanishes when ρ is infinitesimal since $n < 1$.

Hence, proceeding to the limit $R = \infty$ and $\rho = 0$,

$$\int_0^x \frac{e^{ax}}{x^n} dx = x^{1-n} \int_0^\infty \frac{e^{-ay}}{y^n} dy = x^{1-n} \int_0^\infty y^{-n} e^{-ay} dy,$$

$$\int_0^x \frac{\cos ax + i \sin ax}{x^n} dx = \left[\cos(1-n) \frac{\pi}{2} + i \sin(1-n) \frac{\pi}{2} \right] \int_0^\infty y^{-n} e^{-ay} dy;$$

$$\int_0^x \frac{\cos ax}{x^n} dx = \cos(1-n) \frac{\pi}{2} \frac{\Gamma(1-n)}{a^{1-n}} = \frac{\sin \frac{n\pi}{2}}{\Gamma(n)} \frac{1}{a^{1-n}} \cdot \frac{\pi}{\sin n\pi} = \frac{\pi}{2\Gamma(n)a^{1-n}} \frac{1}{\cos \frac{n\pi}{2}},$$

$$\int_0^x \frac{\sin ax}{x^n} dx = \sin(1-n) \frac{\pi}{2} \frac{\Gamma(1-n)}{a^{1-n}} = \frac{\cos \frac{n\pi}{2}}{\Gamma(n)} \frac{1}{a^{1-n}} \cdot \frac{\pi}{\sin n\pi} = \frac{\pi}{2\Gamma(n)a^{1-n}} \frac{1}{\sin \frac{n\pi}{2}},$$

giving the well-known integrals of Fresnel (Art 1166).

1324 (2) Consider $w = \frac{1}{(z^2 + b^2)^{n+1}}$.

Here there are poles of the $n + 1^{\text{th}}$ order at $z = ib$ and at $z = -ib$.

Taking the contour to be the infinite semicircle, the x -axis, and the small circle about $z = ib$ and radius ρ , as before, we have

$$w \equiv f(z) = \frac{\phi(z)}{(z - ib)^{n+1}},$$

where $\phi(z) = \frac{1}{(z + ib)^{n+1}}$ and $\phi^{(n)}(z) = \frac{(-1)^n (n+1)(n+2) \dots (2n)}{(z + ib)^{2n+1}}$,

$$i.e. \quad \phi^{(n)}(ib) = (-1)^n \frac{(2n)!}{n! (2ib)^{2n+1}} = \frac{1}{i} \frac{(2n)!}{n! (2b)^{2n+1}}.$$

Hence $\int \frac{dz}{(z^2 + b^2)^{n+1}} = \frac{2\pi}{(2b)^{2n+1}} \frac{(2n)!}{(n!)^2}$ round the multiple pole ib .

The integration along the x axis is $\int_{-\infty}^{\infty} \frac{dx}{(x^2 + b^2)^{n+1}}$ or $2 \int_0^{\infty} \frac{dx}{(x^2 + b^2)^{n+1}}$.

Round the infinite semicircle we have $\int_0^\pi \frac{iR e^{i\theta} d\theta}{(R^2 e^{2i\theta} + b^2)^{n+1}}$, which obviously vanishes if R be made infinite.

Hence $\int_0^\infty \frac{dx}{(x^2 + b^2)^{n+1}} = \frac{\pi}{(2b)^{2n+1}} \frac{(2n)!}{(n!)^2}$.

The result is readily verified by putting $x = b \tan \theta$, when the integral becomes

$$\frac{1}{b^{2n+1}} \int_0^{\frac{\pi}{2}} \cos^{2n} \theta d\theta.$$

1325. Instead of using the formula $\int \frac{\phi(z)}{(z-a)^{n+1}} dz = \frac{\phi^{(n)}(a)}{n!} 2\pi i$, as above, we might follow the method of Art. 1317, and put $\frac{1}{(z-ib)^{n+1}(z+ib)^{n+1}}$ into Partial fractions so far as is required to find the Partial fraction of

the form $\frac{A}{z-ib}$. We then proceed thus (Art. 144): put $z=ib+y$. We then have

$$\frac{1}{y^{n+1}} \frac{1}{(2ib+y)^{n+1}} = \frac{1}{y^{n+1}} \frac{1}{(2ib)^{n+1}} \left[1 - (n+1) \frac{y}{2ib} + \dots + \frac{(n+1)(n+2) \dots (2n)}{1 \cdot 2 \dots n} (-1)^n \left(\frac{y}{2ib} \right)^n + \dots \right];$$

whence
$$A = \frac{1}{(2ib)^{n+1}} (-1)^n \frac{(n+1)(n+2) \dots (2n)}{1 \cdot 2 \dots n} \cdot \frac{1}{(2ib)^n}$$

$$= \frac{1}{i} \frac{1}{(2b)^{2n+1}} \frac{(2n)!}{(n!)^2},$$

and the value required is $A \cdot 2\pi i$, i.e. $2\pi i$ the multiple pole at $z=ib$ the integral is $\frac{2\pi}{(2b)^{2n+1}} \frac{(2n)!}{(n!)^2}$, as before.

1326. Consider $w \equiv f(z) \equiv \frac{e^{iaz}}{(b^2+z^2)^{n+1}}$, a real and positive.

There is polarity of the $(n+1)^{\text{th}}$ order at the points $z = \pm ib$.

Take the contour as before, viz. an infinite semicircle centred at the origin, the x -axis and an infinitesimal circle round ib .

We have, putting $f(z) \equiv \frac{\phi(z)}{(z-ib)^{n+1}}$, $\phi(z) = \frac{e^{iaz}}{(z+ib)^{n+1}}$,

and
$$\phi^{(n)}(z) = (ia)^n \frac{e^{iaz}}{(z+ib)^{n+1}} - \frac{n}{1} (ia)^{n-1} e^{iaz} \frac{(n+1)}{(z+ib)^{n+2}} + \frac{n(n-1)}{1 \cdot 2} (ia)^{n-2} e^{iaz} \frac{(n+1)(n+2)}{(z+ib)^{n+3}} - \frac{n(n-1)(n-2)}{1 \cdot 2 \cdot 3} (ia)^{n-3} \frac{(n+1)(n+2)(n+3)}{(z+ib)^{n+4}} - \dots + e^{iaz} (-1)^n \frac{(n+1)(n+2) \dots (2n)}{(z+ib)^{2n+1}}$$

And since $\int \frac{\phi(z)}{(z-a)^{n+1}} dz$, round a multiple pole of the n^{th} order, $= \frac{2\pi i}{n!} \phi^{(n)}(a)$, we have, putting ib for a ,

$$\int f(z) dz = \int \frac{\phi(z)}{(z-ib)^{n+1}} dz = \frac{2\pi i}{n!} \left[(ia)^n \frac{e^{-ab}}{(2ib)^{n+1}} - \frac{n}{1} (ia)^{n-1} \frac{e^{-ab}(n+1)}{(2ib)^{n+2}} + \frac{n(n-1)}{1 \cdot 2} (ia)^{n-2} e^{-ab} \frac{(n+1)(n+2)}{(2ib)^{n+3}} - \dots + e^{-ab} (-1)^n \frac{(2n)!}{n! (2ib)^{2n+1}} \right]$$

$$= \frac{2\pi e^{-ab}}{n!} \left[\frac{a^n}{(2b)^{n+1}} + \frac{(n+1)n}{1} \cdot \frac{a^{n-1}}{(2b)^{n+2}} + \frac{(n+2)(n+1)n(n-1)}{2!} \cdot \frac{a^{n-2}}{(2b)^{n+3}} + \dots + \frac{(2n)!}{n!} \frac{1}{(2b)^{2n+1}} \right].$$

Round the outer contour we have

$$\int_{-\infty}^{\infty} \frac{e^{iaz}}{(b^2+x^2)^{n+1}} dx + \int_0^{\infty} \frac{e^{iaz}}{(b^2+x^2)^{n+1}} dx + \int_0^{\pi} \frac{e^{iAR(\cos\theta + i \sin\theta)}}{(b^2 + R^2 e^{2i\theta})} iR e^{i\theta} d\theta.$$

Putting $-x$ for x in the first and combining the result with the second, we get $2 \int_0^{\infty} \frac{\cos ax}{(b^2+x^2)^{n+1}} dx$. The third integral vanishes as the integrand

contains the factor $e^{-aR \sin \theta}$, which vanishes when $R = \infty$, $\sin \theta$ never becoming negative. Hence we obtain

$$\int_0^\infty \frac{\cos ax}{(b^2+x^2)^{n+1}} dx = \frac{\pi}{n!} \frac{e^{-ab}}{(2b)^{2n+1}} \left[(2ab)^n + \frac{(n+1)n}{1!} (2ab)^{n-1} + \frac{(n+2)(n+1)n(n-1)}{2!} (2ab)^{n-2} + \dots + \frac{(2n)!}{n!} \right],$$

which agrees with the result of Art. 1057, writing n for $n+1$ in the present result.

1327. Consider the case $w = z^{n-1}e^{-kz}$, where k is a complex constant $\equiv a - ib$, in which a is positive, b positive and not both zero, and $1 > n > 0$.

Since $n < 1$, there is a pole at the origin. Writing $z = re^{i\theta}$, $k = \rho e^{-i\beta}$, where β is $\gt \pi/2$, we have $w = r^{n-1}e^{i(n-1)\theta}e^{-\rho r \cos(\theta-\beta)}e^{-i\rho r \sin(\theta-\beta)}$, which cannot become infinite, except at $z=0$, unless $\cos(\theta-\beta)$ be negative, i.e. $\theta > \beta + \frac{\pi}{2}$, or $< \beta - \frac{\pi}{2}$, in which case an infinite value of r would make w infinite.

We shall avoid these poles if we take a contour consisting of a sectorial area bounded by $\theta=0$, $\theta=a (< \pi/2)$ and by arcs $r=R_1$, $r=R_2$, where R_1 is infinitely large and R_2 infinitesimally small. The region thus bounded is such that w is synectic within it, and we have

$$\int_{R_2}^{R_1} x^{n-1} e^{-(a-b)x} dx + \int_0^a (R_1 e^{i\theta})^n e^{-(a-b)R_1 e^{i\theta}} i d\theta + \int_{R_1}^{R_2} (r e^{i\alpha})^{n-1} e^{-\rho e^{-i\beta} r e^{i\alpha}} e^{i\alpha} dr + \int_a^0 (R_2 e^{i\theta})^n e^{-(a-b)R_2 e^{i\theta}} i d\theta = 0.$$

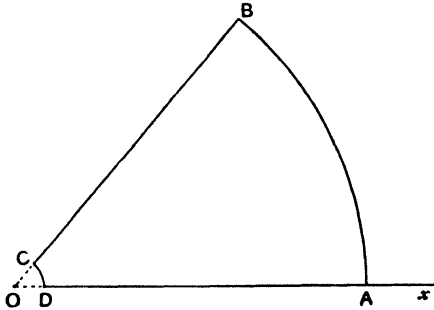

Fig. 417.

The second and fourth integrals contribute nothing, for in the second the integrand contains the factor $R_1^n e^{-\rho R_1 \cos(\theta-\beta)}$, which vanishes when R_1 is infinite, since we are supposing $a < \pi/2$, and therefore, θ being $< a$, $\theta - \beta < \pi/2$; and in the fourth, the integrand contains the factor $R_2^n e^{-\rho R_2 \cos(\theta-\beta)}$, which vanishes when R_2 is infinitesimally small.

Hence, proceeding to the limit when $R_1 \rightarrow \infty$, $R_2 \rightarrow 0$, we have

$$\int_0^\infty x^{n-1} e^{-ax} e^{-bx} dx = e^{n\alpha} \int_0^\infty r^{n-1} e^{-\rho r e^{i(\alpha-\beta)}} dr. \dots\dots\dots(1)$$

If now we choose the angle of the sector, viz. α , to be β , i.e. $\tan^{-1} \frac{b}{a}$, we have

$$\int_0^{\infty} x^{n-1} e^{-ax} e^{bx} dx = e^{n\beta} \int_0^{\infty} x^{n-1} e^{-\rho x} dx, \quad \text{where } \rho = \sqrt{a^2 + b^2},$$

$$= e^{n\beta} \frac{\Gamma(n)}{\rho^n}, \quad \rho \text{ being real,}$$

i.e.
$$\int_0^{\infty} x^{n-1} e^{-(a-ib)x} dx = \frac{\Gamma(n)}{(a-ib)^n},$$

which shows that the theorem $\int_0^{\infty} x^{n-1} e^{-kx} dx = \frac{\Gamma(n)}{k^n}$ is true for a complex constant $k = a - ib$ as well as for a real one, a being positive (see Art. 1159).

Also
$$\int_0^{\infty} x^{n-1} e^{-ax} \cos bx dx = \frac{\Gamma(n)}{(a^2 + b^2)^{\frac{n}{2}}} \cos \left(n \tan^{-1} \frac{b}{a} \right),$$

$$\int_0^{\infty} x^{n-1} e^{-ax} \sin bx dx = \frac{\Gamma(n)}{(a^2 + b^2)^{\frac{n}{2}}} \sin \left(n \tan^{-1} \frac{b}{a} \right) \dots \dots \dots (2)$$

1328. Equation (1) of the previous article gives

$$\int_0^{\infty} x^{n-1} e^{-ax} e^{bx} dx = \int_0^{\infty} x^{n-1} e^{-(a \cos \alpha + b \sin \alpha)x} e^{i n \alpha - x(a \sin \alpha - b \cos \alpha)} dx;$$

whence

$$\int_0^{\infty} x^{n-1} e^{-(a \cos \alpha + b \sin \alpha)x} \cos \{n\alpha - x(a \sin \alpha - b \cos \alpha)\} dx = \int_0^{\infty} x^{n-1} e^{-ax} \cos bx dx,$$

and
$$\int_0^{\infty} x^{n-1} e^{-(a \cos \alpha + b \sin \alpha)x} \sin \{n\alpha - x(a \sin \alpha - b \cos \alpha)\} dx = \int_0^{\infty} x^{n-1} e^{-ax} \sin bx dx,$$

and therefore taking the case when $b = 0$,

$$\int_0^{\infty} x^{n-1} e^{-ax \cos \alpha} \cos \{n\alpha - ax \sin \alpha\} dx = \int_0^{\infty} x^{n-1} e^{-ax} dx = \frac{\Gamma(n)}{a^n},$$

$$\int_0^{\infty} x^{n-1} e^{-ax \cos \alpha} \sin \{n\alpha - ax \sin \alpha\} dx = 0.$$

If we multiply by $\cos n\alpha$ and $\sin n\alpha$ and add,
and by $\sin n\alpha$ and $\cos n\alpha$ and subtract, }
we obtain

$$\int_0^{\infty} x^{n-1} e^{-ax \cos \alpha} \cos \{ax \sin \alpha\} dx = \frac{\Gamma(n)}{a^n} \cos n\alpha,$$

$$\int_0^{\infty} x^{n-1} e^{-ax \cos \alpha} \sin \{ax \sin \alpha\} dx = \frac{\Gamma(n)}{a^n} \sin n\alpha.$$

[Cf. Briot and Bouquet.]

If γ be any other angle, we have upon multiplication by $\cos \gamma$, $\sin \gamma$ and subtracting, and by $\sin \gamma$, $\cos \gamma$ and adding,

$$\int_0^{\infty} x^{n-1} e^{-ax \cos \alpha} \cos \{ax \sin \alpha + \gamma\} dx = \frac{\Gamma(n)}{a^n} \cos \{n\alpha + \gamma\},$$

$$\int_0^{\infty} x^{n-1} e^{-ax \cos \alpha} \sin \{ax \sin \alpha + \gamma\} dx = \frac{\Gamma(n)}{a^n} \sin \{n\alpha + \gamma\}.$$

($\alpha < \pi/2$, $1 > n > 0$, $\alpha + \gamma$.)

PROBLEMS.

1. If $w^2 = z - 1$, examine the value of $\int_0^{z_1} w dz$,

(i) *via* the branch $w = \sqrt{z-1}$ by any path which does not encircle the branch-point at $z = 1$;

(ii) *via* a path starting with the same branch and encircling the branch-point once.

2. Find the values of

$$\int \frac{\sin z}{z-a} dz, \quad \int \frac{\sin z}{(z-a)^2} dz, \quad \int \frac{\sin z}{(z-a)^3} dz,$$

taken round a small circle whose centre is at $z = a$.

3. Find the values of

$$\int \frac{z}{z-a} dz, \quad \int \frac{z^2}{(z-a)^2} dz, \quad \int \frac{z^2}{(z-a)^3} dz \quad \text{and} \quad \int \frac{z^2}{(z-a)^4} dz,$$

taken round a small circle whose centre is at $z = a$.

4. Show that the values of the integral $\int \frac{dz}{(z-2)(z-4)}$, taken round the circles $|z| = 1$, $|z| = 3$, $|z| = 5$, are respectively

$$0, \quad -\pi i \quad \text{and} \quad 0.$$

5. Show that the values of the integral $\int \frac{dz}{(z-2)(z-4)(z-6)}$, taken round the circles $|z| = 1$, $|z| = 3$, $|z| = 5$, $|z| = 7$, are respectively

$$0, \quad \frac{\pi i}{4}, \quad -\frac{\pi i}{4}, \quad 0.$$

6. Show that the values of the integral $\int \frac{z^2 dz}{(z-2)(z-4)(z-6)}$, taken round the circles $|z| = 1$, $|z| = 3$, $|z| = 5$, $|z| = 7$, are respectively

$$0, \quad \pi i, \quad -7\pi i, \quad 2\pi i.$$

7. Show that the value of the integral $\int \frac{dz}{z^2 - 2z + 2}$, taken round a contour consisting of the x -axis, the y -axis and the arc of the circle $|z| = 2$, which lies in the first quadrant, is π .

8. Show that the value of the integral $\int \frac{z^2 dz}{(z-1)^4(z^3+1)}$, taken round a contour consisting of a semicircle of radius greater than unity, with centre at the origin and its diameter the y -axis and lying towards the positive side of the x -axis, is $-\frac{\pi i}{24}$, and the

same integral, taken round the entire circumference of the circle $x^2 + y^2 + 2x = 0$, is $\frac{\pi i}{24}$. Show also that the same integral, taken round the rectangle bounded by $x = 0$, $x = 0.75$, $y = \pm 1$, is $-\frac{2\pi i}{3}$.

9. Show that the integral $\int \frac{dz}{(z^3 + 1)^2}$, taken round a contour which consists of the y -axis and that part of any semicircle $|z| > 1$, which lies on the positive side of the y -axis, is $-\frac{1}{3}\pi i$.

[FORSYTH, *Th. Funct.*, p. 42.]

10. If p and q be positive integers, show by integrating $\int \frac{z^{2p}}{1 + z^{2q}} dz$ round the perimeter of a semicircle of radius a (supposed > 1), having its diameter coincident with the axis of x and its centre at the origin, that

$$\int_{-a}^a \frac{x^{2p}}{1 + x^{2q}} dx + i \int_0^\pi \frac{a^{2p+1} e^{i(2p+1)\theta}}{1 + a^{2q} e^{2qi\theta}} d\theta = \frac{\pi}{q \sin \frac{2p+1}{2q} \pi},$$

and deduce that if $1 > a > 0$,

$$\int_0^\infty \frac{x^{a-1}}{1-x} dx = \frac{\pi}{\sin a\pi}. \quad [\text{MATH. TRIP., 1887.}]$$

11. When is a function said to have a pole? Distinguish between a pole and an *essential* singularity; show that a function which is everywhere regular is a constant.

From consideration of the integral $\int \frac{e^{iz} dz}{(z-a)^2 + b^2}$, where a and b are real positive quantities, taken round a suitable boundary, show that

$$\int_0^\infty \frac{\cos x}{(x-a)^2 + b^2} dx + 2a \int_0^\infty \frac{e^{-y} dy}{(a^2 + b^2 - y^2)^2 + 4a^2 y^2} = \frac{\pi \cos a}{be^b},$$

$$\int_0^\infty \frac{\sin x}{(x-a)^2 + b^2} dx - \int_0^\infty \frac{e^{-y}(a^2 + b^2 - y^2) dy}{(a^2 + b^2 - y^2)^2 + 4a^2 y^2} = \frac{\pi \sin a}{be^b},$$

[I. C. S., 1908.]

12. Determine a function which shall be regular within the circle $|z| = 1$, and shall have at the circumference of this circle the value

$$\frac{(a^2 - 1) \cos \theta + i(a^2 + 1) \sin \theta}{a^4 - 2a^2 \cos 2\theta + 1},$$

where $a^2 > 1$, θ denoting the vectorial angle.

[I. C. S., 1909.]

13. Establish by contour integration the result

$$\int_0^\infty \frac{x^2 dx}{(x^2 - a^2)^2 + b^2 x^2} = \frac{\pi}{2b},$$

b being positive.

[I. C. S., 1910.]

14. By considering the contour integral

$$\int \frac{e^{az}}{1-e^z} dz, \quad (0 < a < 1),$$

round a rectangle of infinite length ($x = -\infty$ to $+\infty$), and finite breadth ($y=0$ to π) with a small semicircle excluding the origin, prove that

$$\int_{-\infty}^{\infty} \frac{e^{ax}}{1+e^x} dx = \pi \operatorname{cosec} \pi a. \quad [\text{I. C. S., 1903.}]$$

15. If a, b be two quantities each of the form $\alpha + \beta i$, explain the meaning of the integration $\int_a^b \phi(z) dz$, and point out in what cases the value of the integral is dependent on the path chosen between the limits. [ST. JOHN'S COLL., 1881.]

16. Prove that, a being positive,

$$\begin{aligned} \int_0^{\infty} \frac{e^{-2ax} \cos x^2}{1+e^x} dx &= \int_0^{\infty} \sin(a'^2 - a^2) da'; \\ \int_0^{\infty} \frac{e^{-2ax} \sin x^2}{1+e^x} dx &= \int_0^{\infty} \cos(a'^2 - a^2) da'. \end{aligned}$$

[SMITH'S PRIZE, 1876.]

17. Evaluate the integral $\int \frac{\sin z}{z^3 - a^3} dz$, taken round the unit circle in the counter-clockwise sense, where a is any real number other than ± 1 . [MATH. TRIP., PT. II., 1920.]

18. Evaluate the integral $\int \frac{\log(z-a)}{z-a} dz$, taken round the unit circle in the counter-clockwise sense, where a is any real number other than ± 1 , and the logarithm has its principal value. [MATH. TRIP., PT. II., 1920.]

19. Explain what is meant by a period of an integral of a function, and investigate the periods of the integrals

$$\int \frac{dz}{1+z^2}, \quad \int (1-z^2)^{-\frac{1}{2}} dz, \quad \int (1-z^2)^{\frac{1}{2}} dz.$$

[MATH. TRIP., PT. II., 1913.]

20. Show, by contour integration round an infinite semicircle and its diameter, that

$$\begin{aligned} \int_0^{\infty} \frac{x^{\frac{1}{2}} dx}{x^2 + x + 1} &= \frac{\pi}{\sqrt{3}}, & \int_0^{\infty} \frac{x^{\frac{1}{2}} dx}{x^2 - x + 1} &= \pi, \\ \int_0^{\infty} \frac{x^{\frac{1}{2}} dx}{x^2 + x + 1} &= \frac{4\pi}{3} \sin \frac{\pi}{9}, & \int_0^{\infty} \frac{x^{\frac{1}{2}} dx}{x^2 - x + 1} &= \frac{4\pi}{3} \sin \frac{2\pi}{9}. \end{aligned}$$

21. Discuss, by contour integration round an infinite semicircle and its diameter, $\int \frac{z^p dz}{z^2 + 2z \cos \alpha + 1}$, where p lies between ± 1 and $0 < \alpha < \pi$.

22. Prove that $\int_0^{\frac{\pi}{2}} \log \cos \theta d\theta = \frac{\pi}{2} \log \frac{1}{2}$, by consideration of the integral $\int \log \frac{1}{2} \left(z + \frac{1}{z} \right) \frac{dz}{z}$ taken round a suitable contour.

23. By consideration of the integration $\int e^{-a^2 z^2} dz$ round the perimeter of an infinite rectangle of breadth b/a^2 , establish Laplace's integral of Art. 1041, a being real.

24. By consideration of $\int e^{-a^2 z^2} dz$ round an infinite rectangle of breadth b , a being real and positive, prove that

$$\int_0^{\infty} e^{-a^2 x^2 (x^2 - b^2)} \cos \{4a^2 b x (x^2 - b^2)\} dx = \frac{e^{a^2 b^4}}{4a} \Gamma\left(\frac{1}{4}\right).$$

25. By integration of $\int \frac{e^{kz}}{z^4 + 4a^4} dz$ round an infinite quadrant, where a and k are real and positive, show that

$$\int_0^{\infty} \frac{\cos kx}{x^4 + 4a^4} dx = \frac{\pi}{8a^3} e^{-ka} (\sin ka + \cos ka);$$

$$\int_0^{\infty} \frac{\sin kx - e^{-kx}}{x^4 + 4a^4} dx = \frac{\pi}{8a^3} e^{-ka} (\sin ka - \cos ka).$$

CHAPTER XXXI.

ELLIPTIC INTEGRALS AND FUNCTIONS.

1329. The Legendrian Standard Integrals and the Jacobian Functions.

In proceeding to the further consideration of the Jacobian Elliptic Functions $\operatorname{sn} u$, $\operatorname{cn} u$, $\operatorname{dn} u$ already introduced in Chapter XI, we shall adopt the same order of discussion as that followed in the description of the ordinary circular functions and of their inverses in Trigonometry; viz.

(1) The nature of their Periodicity; (2) The establishment of their Addition Formulae; (3) The examination of formulae arising therefrom.

We have defined $\operatorname{sn}(u, k)$ as the value of z , which makes $u = \int_0^z \frac{dz}{\sqrt{(1-z^2)(1-k^2z^2)}}$, where $k < 1$, and $\operatorname{cn}(u, k)$, $\operatorname{dn}(u, k)$ are defined as $\sqrt{1-z^2}$ and $\sqrt{1-k^2z^2}$ respectively.

1330. Periodicity of the Extended Circular Functions.

Let us examine first the simpler integral $u = \int_0^z \frac{dz}{\sqrt{1-z^2}}$, the function $\sin u$ being considered as not hitherto known, but now defined by the equation $z = \sin u$, so that the inverse function $\sin^{-1}z$ is $\int_0^z \frac{dz}{\sqrt{1-z^2}}$, and z is not restricted to real values, but may be a complex variable.

1331. If we write $w^2 = \frac{1}{1-z^2}$, w is a two-branched function, its two branches being $w_1 = +\frac{1}{\sqrt{1-z^2}}$ and $w_2 = -\frac{1}{\sqrt{1-z^2}}$, and individually characterised as assuming the respective values $+1$ and -1 at the origin.

The branch-points are at $z=1$ and at $z=-1$. These points are also poles of the function. There are no other singularities.

The region between an infinite circle whose centre is the origin O , and a double loop enclosing the two branch-points, is synectic, and the infinite circle is therefore deformable into and reconcilable with the double loop. Hence, considering either branch, say w_1 , $\int w_1 dz$ taken round the infinite circle has the same value as $\int w_1 dz$ taken in the same sense round the double loop.

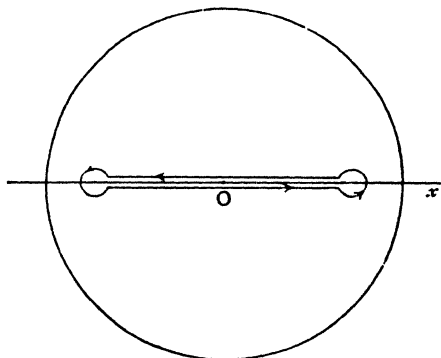

Fig. 418.

Now round the infinite circle, along which we may put $z = Re^{i\theta}$ and $dz/z = i d\theta$, where R is infinite, we have

$$\begin{aligned} \int w_1 dz &= \int \frac{dz}{\sqrt{1-z^2}} = \frac{1}{i} \int \frac{dz}{z}, \quad |z| \text{ being very large,} \\ &= \frac{1}{i} \int_0^{2\pi} i d\theta = 2\pi. \end{aligned}$$

Hence $\int w_1 dz$, taken round the double loop, is also $= 2\pi$.

Again, in integrating round an infinitesimal circle whose centre is at the branch-point $z = 1$, put $z = 1 + re^{i\theta}$.

$$\text{Then} \quad \int w_1 dz = \int_0^{2\pi} \frac{ire^{i\theta} d\theta}{\sqrt{2+re^{i\theta}}\sqrt{-re^{i\theta}}} = \sqrt{r} \int_0^{2\pi} \frac{e^{i\theta/2} d\theta}{\sqrt{2+re^{i\theta}}} = 0,$$

when r is indefinitely diminished. Similarly the integral round the infinitesimal circle with centre at $z = -1$ also vanishes.

Hence the integral for the loop round $z = 1$ is in the limit

$$= \int_0^1 w_1 dz + \int_c w_1 dz + \int_1^0 w_2 dz,$$

where $\int_c w_1 dz$ indicates the integration for the circuit round $z = 1$; and w_1 has changed into w_2 after performing the circuit once (Fig. 419); and since $w_2 = -w_1$, this reduces to

$$= 2 \int_0^1 w_1 dz \equiv 2 \int_0^1 \frac{dz}{\sqrt{1-z^2}} = L_1, \text{ say.}$$

Similarly, the value of the integral $\int w_1 dz$ for the loop round $z = -1$ is

$$= \int_0^{-1} w_1 dz + \int_{c'} w_1 dz + \int_{-1}^0 w_2 dz,$$

where c' refers to the circuit of the infinitesimal circle round $z = -1$ and $\int_{c'} w_1 dz$ vanishes. Hence, for this loop, we have

$$\begin{aligned} \int_0^{-1} w_1 dz + \int_0^{-1} w_1 dz &= 2 \int_0^{-1} w_1 dz = 2 \int_0^{-1} \frac{dz}{\sqrt{1-z^2}} \\ &= -2 \int_0^1 \frac{dz}{\sqrt{1-z^2}} = L_{-1}, \text{ say.} \end{aligned}$$

Thus $L_1 + L_{-1} = 0$
 and $L_1 - L_{-1} = \text{integral for the whole loop} = 2\pi ;$ }
 $\therefore L_1 = \pi, \quad L_{-1} = -\pi ; \text{ i.e. } \int_0^1 \frac{dz}{\sqrt{1-z^2}} = \frac{\pi}{2} \text{ and } \int_0^{-1} \frac{dz}{\sqrt{1-z^2}} = -\frac{\pi}{2},$

the direction of travel in each case being the "positive" direction as defined earlier.

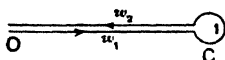

Fig 419.

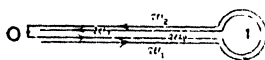

Fig 420.

Now, if one of the branch-points, say $z=1$, be encircled *twice*, the path starting from the origin and returning to it after two encirclings, may be deformed into two loops round the point, and the integral, leaving out the integrals for the two infinitesimal circuits about the branch-point, which vanish, is $= \int_0^1 w_1 dz + \int_1^0 w_2 dz + \int_0^1 w_2 dz + \int_1^0 w_1 dz$, which is zero, and w_1 has changed to w_2 and back to w_1 in the double circuit, i.e. to its original value at the origin.

Thus, for a loop with an *even* number of circuits round one pole, we have a zero contribution with no aggregate change of branch, but for a loop with an *odd* number of circuits round one pole, the equivalent is obviously a single loop, $= 2 \int_0^1 w_1 dz = \pi$, accompanied by a change of branch from w_1 to w_2 on arriving back at the origin.

The same thing happens for several encirclements of $z = -1$, starting from the origin with value w_1 , except that for an *odd* number we have a contribution $2 \int_0^{-1} w_1 dz = -\pi$; and w_1 has become w_2 or w_1 according as

there have been an *odd* or an *even* number of encirclings of the branch-point.

When *both* branch-points are encircled n times in the positive direction, the integral will be $n \cdot 2\pi$ with no change of branch, or if the pair be encircled p times in the positive direction and q times in the negative direction, the contribution will be $(p - q) 2\pi = 2n \cdot \pi$, where n is the excess of the number of positive encirclements over the number of negative ones. And such an encircling of both points will result in w_1 being restored as the final branch of the function when z has returned to the starting point.

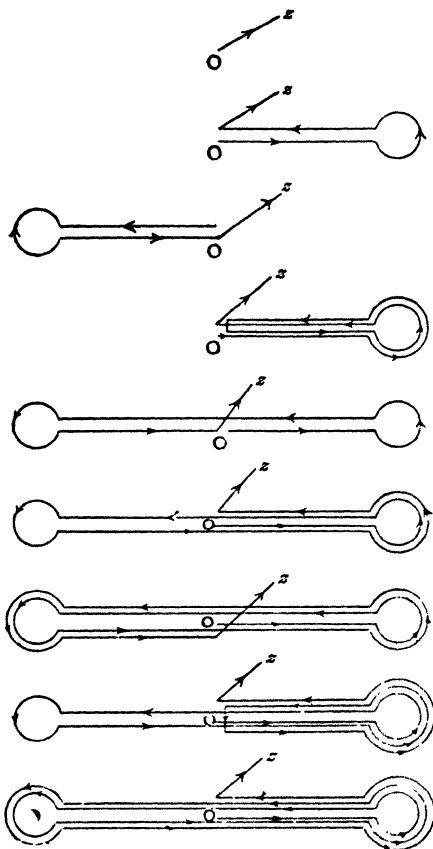

Fig. 421.

to the origin with a value w_1 or a value w_2 for the function, and the total for any path will be u_0 or $-u_0$, as the case may be, together with whatever may accrue from the several encirclings of the branch-points.

Thus the total values of the integral $\int_0^z w_1 dz$ are

(1) for the direct path alone,
$$\int_0^z w_1 dz = u_0 ;$$

Now any path from O to z is reconcilable with a linear direct path, together with such loops as have been described above or some combination of them.

And if $\int_0^z w_1 dz$ along the straight path be called u_0 , the contribution to the total integral from O to z by any other path deformable into the straight line OP with a system of loops will be $+u_0$ or $-u_0$, according as z , after having described its loop system and before commencing the portion OP , has returned

- (2) for an *odd* number of circuits of one loop + a direct path, $\left. \begin{array}{l} \\ \end{array} \right\} \begin{array}{l} = L_1 - u_0 \\ \text{or} = L_{-1} - u_0; \end{array}$
- (3) for an *even* number of encirclements of one branch-point + a direct path, $\left. \begin{array}{l} \\ \end{array} \right\} = u_0;$
- (4) for n encirclements of both branch-points + a direct path, $\left. \begin{array}{l} \\ \end{array} \right\} = n(L_1 - L_{-1}) + u_0;$
- (5) for n complete encirclements of both branch-points combined with an *odd* number of encirclements of one of them + a direct path, $\left. \begin{array}{l} \\ \end{array} \right\} \begin{array}{l} = n(L_1 - L_{-1}) + L_1 - u_0 \\ \text{or} = n(L_1 - L_{-1}) + L_{-1} - u_0; \end{array}$
- (6) for n complete encirclements of both branch-points with an *even* number of encirclements of one + a direct path, $\left. \begin{array}{l} \\ \end{array} \right\} = n(L_1 - L_{-1}) + u_0;$

and seeing that $L_1 - L_{-1}$ would be replaced by $-L_1 + L_{-1}$ if the description were in the opposite direction, these results are all of one or other of the forms $2p\pi + u_0$ or $(2p + 1)\pi - u_0$, i.e. $p\pi + (-1)^p u_0$,

p being some integer positive or negative.

If then, in the equation $u = \int_0^z \frac{dz}{\sqrt{1-z^2}}$, we express z as $z = \phi(u)$, it appears that as all these paths lead finally to the same point z , we must have $\phi(u)$ the same for all the paths

$$= \phi(u_0), \text{ i.e. } \phi(u_0) = \phi\{p\pi + (-1)^p u_0\},$$

and the general solution of the equation $\phi(u) = \phi(u_0)$ is $u = p\pi + (-1)^p u_0$.

This is the ordinary result of trigonometry, and for a real variable it is a well-known theorem that $\sin u = \sin\{p\pi + (-1)^p u\}$.

1332. Let us next put $\sqrt{1-z^2} = \chi(u)$, and enquire which of the above values of u lead to the same value of $\sqrt{1-z^2}$.

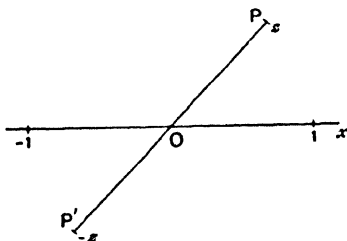

Fig. 422.

Clearly the function $\sqrt{1-z^2}$ has the same value at $P_s, (-z)$, as it has at $P_s, (z)$ (Fig. 422).

Hence, besides the various paths which lead from O to P must be considered those which lead from O to P' . And it is not all the paths

which have been considered from O to P thus restoring the value z at P , which *also restore the value of* $\sqrt{1-z^2}$. For after a description of an odd number of single loops, $\sqrt{1-z^2}$ has become $-\sqrt{1-z^2}$. Hence, in order to arrive at P or at P' with the value $+\sqrt{1-z^2}$, we can only take the cases of description of an even number of single loops; also a double loop traversed any number of times will restore the value $+\sqrt{1-z^2}$.

We therefore have the following cases :

(1) for a direct path from O to P , u_0 ;

(2) for a direct path from O to P' ,

$$\int_0^{-z} \sqrt{1-z^2} dz = - \int_0^z \sqrt{1-z^2} dz = -u_0 ;$$

(3) for an even number of loops round either branch-point } u_0 ;
+ a direct path OP ,

(4) for an even number of loops round either branch-point } $-u_0$;
+ a direct path OP' ,

(5) for any number of double loops + direct path OP , $2n\pi + u_0$;

(6) for any number of double loops + direct path OP' , $2n\pi - u_0$;

(7) for any number of double loops + any even number of } $2n\pi + u_0$;
single loops + a direct path OP ,

(8) for any number of double loops + any even number of } $2n\pi - u_0$.
single loops + a direct path OP' ,

Hence it appears that the values of u which lead to the same value of $\sqrt{1-z^2}$ are exactly comprised in and expressed by $2n\pi \pm u_0$, i.e.

$$\text{if } \sqrt{1-z^2} = \chi(u), \text{ then } \chi(u) = \chi(2n\pi \pm u),$$

and the general solution of the equation $\chi(u) = \chi(u_0)$ is $u = 2n\pi \pm u_0$.

Thus, defining $\cos u$ as $+\sqrt{1-z^2}$, where $u = \int_0^z \frac{dz}{\sqrt{1-z^2}}$, we have

$\cos u = \cos(2n\pi \pm u)$, and the solution of $\cos u = \cos u_0$ is $u = 2n\pi \pm u_0$, which for real values of u is the well-known trigonometrical result.

1333. Further, in the case when on the whole an *odd* number of single loops have been described, $\sqrt{1-z^2}$ has on the return of z to the origin become $-\sqrt{1-z^2}$, and along the direct path to P we have

$$\int_0^z \frac{dz}{-\sqrt{1-z^2}} = -u_0,$$

and along the direct path to P' we have

$$\int_0^{-z} \frac{dz}{-\sqrt{1-z^2}} = u_0.$$

So that on the whole we have, for the double loops, $2n\pi$; for an odd number of single loops, $\pm\pi$; for the final path OP or OP' , $\pm u_0$, giving the general value of u as $(2n \pm 1)\pi \pm u_0$ i.e. $(2\lambda + 1)\pi + u_0$. And these values will give $-\sqrt{1-z^2}$ at the final position, i.e. $\chi(u) = -\chi\{(2\lambda + 1)\pi + u\}$, which is the same as the corresponding result of trigonometry, viz., λ being an integer, $\cos u = -\cos\{(2\lambda + 1)\pi + u\}$

1334. From the integral $u = \int_0^z \frac{dz}{\sqrt{1-z^2}}$ it is also *directly* obvious by expansion and integration that u is an odd function of z , in which the first term of the expansion in powers of z is z ; and, therefore, by reversion of series, that z is an odd function of u , in which the first term of the expansion in powers of u is u . Hence it appears, from this consideration also, that if $z = \phi(u)$, then $\phi(u) = -\phi(-u)$. And further, since $\sqrt{1-z^2}$ is an *even* function of u , we have $\chi(u) = \chi(-u)$. Also $Lt_{u=0} z = 1$, i.e. $Lt_{u=0} \frac{\sin u}{u} = 1$.

1335. **Periodicity of the Elliptic Functions.**

We now turn to the consideration on similar lines of

$$u = \int_0^z \frac{dz}{\sqrt{(1-z^2)(1-k^2z^2)}},$$

where k is a real quantity < 1 . This may also be written as

$$u = \int_0^\theta \frac{d\theta}{\sqrt{1-k^2 \sin^2 \theta}},$$

where $z = \sin \theta$.

Let $K = \int_0^1 \frac{dz}{\sqrt{(1-z^2)(1-k^2z^2)}}$ and $K' = \int_0^1 \frac{dz}{\sqrt{(1-z^2)(1-k'^2z^2)}}$,

where $k^2 + k'^2 = 1$.

The function defined by

$$w^2 = \frac{1}{(1-z^2)(1-k^2z^2)}$$

is a two-branched function, viz.

$$w_1 = \frac{1}{\sqrt{(1-z^2)(1-k^2z^2)}}, \quad w_2 = -\frac{1}{\sqrt{(1-z^2)(1-k^2z^2)}},$$

having four branch-points A, B, C, D , viz.

$$z = \frac{1}{k}, \quad z = 1, \quad z = -\frac{1}{k}, \quad z = -1,$$

symmetrically situated about the origin on the x -axis.

Let P be the point z .

.P

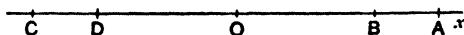

Fig. 423.

There are no branch-points other than A, B, C, D (Art. 1296). These branch-points are also poles of the function, and there

are no other singularities of any kind. We shall first consider

the integration $\int_0^{\frac{1}{k}} \frac{dz}{\sqrt{(1-z^2)(1-k^2z^2)}}$, the path of the integration being:

(1) along the x -axis from $x=0$ to $x=1-\rho$, viz. O to L in Fig. 424;

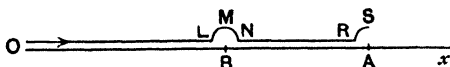

Fig. 424.

(2) round the small semicircle LMN , centre at $z=1$ and radius ρ ;

(3) along the x -axis from $x=1+\rho$ to $\frac{1}{k}-\rho$, viz. NR in the figure;

(4) along a quadrantal arc, centre at $z=\frac{1}{k}$ and radius ρ , viz. RS .

In this integration which passes the point B , where $z=1$, the sign of $1-z$ changes at B and the integrand becomes imaginary. We have then to examine the behaviour of the factor $\sqrt{1-z}$ as we pass round the semicircle LMN , but do not complete the circuit, about the branch-point. Put

$$z = 1 + \rho e^{i\theta}.$$

Then $\sqrt{1-z} = \sqrt{-\rho e^{i\theta}}$, and in passing round the semicircle LMN above B , θ decreases from $\theta=\pi$ to $\theta=0$, and $\sqrt{1-z}$ changes from the value $\sqrt{-\rho e^{i\pi}}$ at L to the value $\sqrt{-\rho e^{i0}}$ at N ; that is, its value has been multiplied by $e^{-\frac{i\pi}{2}}$ or $-i$ in passing round the semicircle.

Therefore w_1 becomes ιw_1 in passing over B .

If we pass under B , we have a change in $\sqrt{1-z}$ from the value $\sqrt{-\rho e^{i\pi}}$ at L to the value $\sqrt{-\rho e^{i2\pi}}$ at N , and therefore the value at L would be multiplied by $e^{i\pi}$ in passing to N ; that is, w_1 would become $-i w_1$.

Since the value of $\sqrt{1-z}$ at L may be written as $\sqrt{\rho}$, where ρ is $1-x$, x being the abscissa of L , it becomes $-i\sqrt{\rho}$ at N ,

where $\rho = x - 1$, x being now the abscissa of N , and along NR there is no further change of amplitude. Hence

From O to L $\sqrt{1-z} = \sqrt{1-x}$, x increasing from 0 to $1-\rho$.

From L to N } $\sqrt{1-z} = \sqrt{1-\rho e^{i\theta}}$, θ decreasing from π to 0.
 round LMN

From N to A $\sqrt{1-z} = i\sqrt{x-1}$, x increasing from $1+\rho$ to $\frac{1}{k}$.

The factor $\sqrt{1-kz} = \sqrt{1-kx}$ from O to R . But A being in this case a branch-point, we take a quadrantal arc with centre A and small radius ρ , avoiding the branch-point.

Put $z = \frac{1}{k} + \rho e^{i\theta}$. Then $\sqrt{1-kz} = \sqrt{-k\rho e^{i\theta}}$, in which θ decreases from $\theta = \pi$ to $\theta = \frac{\pi}{2}$. We thus have as the contributions from OL , LMN , NR and RS respectively,

$$\int_0^{1-\rho} \frac{dx}{\sqrt{(1-x^2)(1-k^2x^2)}}, \quad \int_{\pi}^0 \frac{i\rho e^{i\theta} d\theta}{\sqrt{-\rho e^{i\theta}(2+\rho e^{i\theta})[1-k^2(1+\rho e^{i\theta})^2]}}$$

$$\int_{1+\rho}^{\frac{1}{k}} \frac{dx}{i\sqrt{(x^2-1)(1-k^2x^2)}} \quad \text{and} \quad \int_{\pi}^{\frac{\pi}{2}} \frac{i\rho e^{i\theta} d\theta}{-i\sqrt{\left\{\left(\frac{1}{k} + \rho e^{i\theta}\right)^2 - 1\right\}(-k\rho e^{i\theta})(2+k\rho e^{i\theta})}}$$

and when ρ is indefinitely small the second and fourth vanish and the first is ultimately K . Transform the third by writing $k^2x^2 + k'^2x'^2 = 1$; whence

$$dx = \frac{1}{k} \frac{k'^2 x' dx'}{\sqrt{1-k'^2 x'^2}} \quad \text{and} \quad \sqrt{x^2-1} = \sqrt{\frac{1-k'^2 x'^2}{k^2} - 1} = \frac{k'}{k} \sqrt{1-x'^2}.$$

Hence the third becomes ultimately

$$i \int_{1/k}^1 \frac{dx}{\sqrt{(x^2-1)(1-k^2x^2)}} = i \int_1^0 \left(-\frac{1}{k}\right) \frac{k'^2 x' dx'}{\sqrt{1-k'^2 x'^2}} \frac{k}{k' \sqrt{1-x'^2}} \frac{1}{k' x'}$$

$$= i \int_0^1 \frac{dx'}{\sqrt{(1-x'^2)(1-k'^2 x'^2)}} = iK';$$

that is, $\int_0^1 \frac{dx}{\sqrt{(1-x^2)(1-k^2x^2)}} = K + iK'$, via a path above B ,

and $= K - iK'$, via a path below B .

It follows that $\text{sn}(K + iK') = \frac{1}{k}$.

Now, noting that $\frac{1}{k}$ is the value of x when $x'=0$, and that $\sqrt{x^2-1}=\frac{k'}{k}\sqrt{1-x'^2}$, we have

$$i\sqrt{1-\frac{1}{k^2}}=\frac{k'}{k}, \quad \text{i.e. } \sqrt{1-\frac{1}{k^2}}=-\frac{ik'}{k};$$

$$\therefore \text{cn}(K+iK')=-\frac{ik'}{k}; \quad \text{also } \text{dn}(K+iK')=\sqrt{1-k^2}\frac{1}{k^2}=0.$$

1336. Remembering that when

$$u=\int_0^{\theta} \frac{d\theta}{\sqrt{1-k^2\sin^2\theta}}=\int_0^x \frac{dx}{\sqrt{(1-x^2)(1-k^2x^2)}},$$

$$K=\int_0^{\frac{\pi}{2}} \frac{d\theta}{\sqrt{1-k^2\sin^2\theta}}=\int_0^1 \frac{dx}{\sqrt{(1-x^2)(1-k^2x^2)}},$$

and $x=\sin\theta=\text{sn } u$, also observing that $x=0$ gives $u=0$, we have $\text{sn } 0=0$, whence $\text{cn } 0=1$ and $\text{dn } 0=1$; also $\text{sn } K=1$, whence $\text{cn } K=0$ and $\text{dn } K=\sqrt{1-k^2}=k'$.

1337. Again, if we write $-\theta$ for θ ,

$$u=\int_0^{\theta} \frac{d\theta}{\sqrt{1-k^2\sin^2\theta}}=-\int_0^{-\theta} \frac{d\theta}{\sqrt{1-k^2\sin^2\theta}};$$

$$\therefore -u=\int_0^{-\theta} \frac{d\theta}{\sqrt{1-k^2\sin^2\theta}}.$$

Therefore $-\theta=\text{am}(-u)$; $\text{sn}(-u)=-\sin\theta=-\text{sn } u$;
also $\text{cn}(-u)=\text{cn } u$; and $\text{dn}(-u)=\text{dn } u$.

1338. It also appears directly from the integral

$$u=\int_0^z \frac{dz}{\sqrt{(1-z^2)(1-k^2z^2)}},$$

by expansion, that u is an *odd* function of z whose first term is z , and therefore, by reversion of series, that z is an *odd* function of u , the first term of the expansion being u , and therefore also that $Lt_{u=0} \frac{\text{sn } u}{u}=1$.

Also that, since $\text{cn } u=\sqrt{1-\text{sn}^2 u}$ and $\text{dn } u=\sqrt{1-k^2\text{sn}^2 u}$, $\text{cn } u$ and $\text{dn } u$ are both *even* functions of z ($=\text{sn } u$), the first terms of the expansions being in each case unity. These facts also show that

$\text{sn}(-u)=-\text{sn } u$, $\text{cn}(-u)=\text{cn } u$, $\text{dn}(-u)=\text{dn } u$,
as seen before.

1339. **The Elliptic Functions of $0, K, K+iK'$.** Collected Results.

We thus have

$$\begin{aligned} \operatorname{sn} 0 &= 0, & \operatorname{cn} 0 &= 1, & \operatorname{dn} 0 &= 1, \\ \operatorname{sn} K &= 1, & \operatorname{cn} K &= 0, & \operatorname{dn} K &= k', \\ \operatorname{sn}(K+iK') &= \frac{1}{k}, & \operatorname{cn}(K+iK') &= -\frac{ik'}{k}, & \operatorname{dn}(K+iK') &= 0. \end{aligned}$$

1340. **General Values.**

We shall now consider the variety of values of u which will accrue from the integral

$$u = \int_0^z \frac{dz}{\sqrt{(1-z^2)(1-k^2z^2)}}$$

in integrating from the origin to the point P , viz. z , along the different paths which may occur, as was done in Art. 1331, for

$$\int_0^z \frac{dz}{\sqrt{1-z^2}}$$

There are four branch-points A, B, C, D , and four loops and it has been seen in Art. 1294 that for such a system any

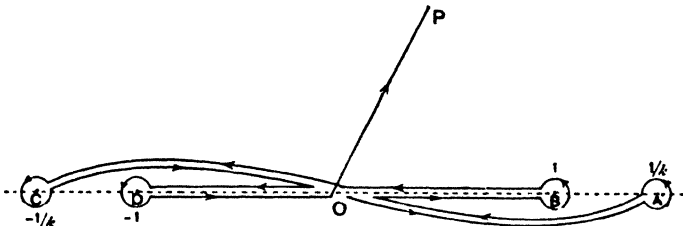

Fig. 425.

path starting from O and terminating at P is deformable into and reconcilable with

- (1) a straight line from O to P
- or (2) a straight-line path from O to P , together with a combination of loops,

and that in any system of loops about four branch-points there are two and only two groups which give different values to the integral taken from O to P , viz.

- (i) those which consist of the integrations for sets of double loops + a direct path
- or (ii) those which consist of the integrations for sets of double loops + a single loop + a direct-path.

Moreover, resuming the notation of Art. 1292, any two of the six possible double-loop systems may be selected as independent. This time we shall take these two double-loop systems as (AB) and (BD) , and (B) as the principal single loop; and remembering that after every travel round a loop the branches of the function interchange, we have

$$u = \lambda(AB) + \mu(BD) + u_0 \quad \text{or} \quad u = \lambda'(AB) + \mu'(BD) + (B) - u_0$$

as the only possible forms of the result, where u_0 denotes, as before, integration along the straight-line path OP starting with the branch w_1 , *i.e.* the same branch with which the whole integration was started from O .

$$\text{Now } (A) = \int_0^{\frac{1}{k}} w_1 dz + \int_a w_1 dz + \int_{\frac{1}{k}}^0 w_2 dz, \text{ where } \int_a w_1 dz \text{ refers}$$

to the integration round an infinitesimal circle with centre at A , which vanishes;

$$\therefore (A) = 2 \int_0^{\frac{1}{k}} w_1 dz = 2(K \pm iK'),$$

the $+$ or the $-$ according as we pass over or under B in arriving at A ;

$$(B) = 2 \int_0^1 w_1 dz = 2K;$$

$$(C) = 2 \int_0^{-\frac{1}{k}} w_1 dz = -2 \int_0^{\frac{1}{k}} w_1 dz = -2(K \pm iK');$$

$$(D) = 2 \int_0^{-1} w_1 dz = -2 \int_0^1 w_1 dz = -2K;$$

and $(AB) = (A) - (B) = \pm 2iK'$; $(BD) = (B) - (D) = 4K$.

Hence the general values of the integral which accrue are

$$\left. \begin{aligned} u &= 2\lambda iK' + 4\mu K + u_0 \\ \text{or} \quad u &= 2\lambda' iK' + 4\mu' K + 2K - u_0 \end{aligned} \right\} \text{where } \lambda, \mu, \lambda', \mu' \text{ are integers;}$$

that is, $u = 2p iK' + 2qK + (-1)^n u_0$, where p, q are integers.

If we write $z = \phi(u) = \phi(u_0)$, it follows that

$$\phi(u_0) = \phi\{2p iK' + 2qK + (-1)^n u_0\};$$

and taking q an even integer $= 2r$,

$$\phi(u_0) = \phi(2p iK' + 4rK + u_0),$$

so that $2iK'$ and $4K$ are independent periods of this function.

Conversely, it follows that the general solution of the equation $\phi(u) = \phi(u_0)$ is $u = 2p_1K' + 2qK + (-1)^n u_0$, and $\phi(u)$ is the Jacobian function $\text{sn } u$.

Hence $\text{sn } u_0 = \text{sn}(2p_1K' + 2qK + (-1)^n u_0)$
 or, which is the same thing, putting $(-1)^n u_0 = v$,
 $\text{sn}(2p_1K' + 2qK + v) = \text{sn}(-1)^n v = (-1)^n \text{sn } v$.

As particular cases of this double periodicity, we have

$$\begin{aligned} \phi(u) &= \phi(4K + u) = \phi(2K - u) = \phi(4K + 2iK' + u) = \phi(6K - u) = \phi(2iK' + u) \\ &= \phi[4(K + iK') + u] = \text{etc.} \end{aligned}$$

1341. Having defined z as a function of u , $\equiv \phi(u)$, by the equation

$$u \equiv \int_0^z \frac{dz}{\sqrt{(1-z^2)(1-k^2z^2)}}$$

let us examine the periodicity of the expressions

$$\sqrt{1-z^2} \equiv \chi(u) \equiv \chi(u_0) \quad \text{and} \quad \sqrt{1-k^2z^2} \equiv \psi(u) \equiv \psi(u_0)$$

regarded as functions of u .

Let P and P' be the points z and $-z$ respectively. Then, as z travels from O along any path which terminates either at P or at P' , starting with the respective branches for which $\chi(0) = 1$ and $\psi(0) = 1$, we are to arrive at P or at P' with the

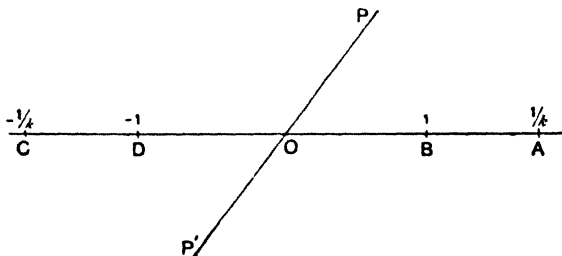

Fig. 426.

values $+\sqrt{1-z^2}$ and $+\sqrt{1-k^2z^2}$ respectively. And this will be effected, provided that either no change has occurred in the branches of the functions in the paths followed, or provided that in either case an even number of such changes have occurred. Such changes of branch occur

- in $\chi(u)$ at each looping of B or of D , but not of A or C ;
- in $\psi(u)$ at each looping of A or of C , but not of B or D .

Hence in the case of $\chi(u)$ the number of times a single loop has been formed about B or about D must be even, but a double loop round B and D may occur any number of times. A double loop about A and B counts as a single loop about B .

In the case of $\psi(u)$ the number of times a single loop has been formed about A or about C must be even, but a double loop round A and C may occur any number of times. A double loop about A and B counts as a single loop about A .

Again, if the integral for the direct linear path OP be denoted as before by u_0 , that for OP' is

$$\int_0^{-z} \frac{dz}{\sqrt{(1-z^2)(1-k^2z^2)}} = - \int_0^z \frac{dz}{\sqrt{(1-z^2)(1-k^2z^2)}} = -u_0.$$

It has been seen that for the variety of paths from O to P the general value of the integral u is

$$u = \lambda(AB) + \mu(BD) + u_0 \quad \text{or} \quad u = \lambda'(AB) + \mu'(BD) + (B) - u_0.$$

It follows that the general value of the integral from O to P' will be expressed by

$$u = \lambda(AB) + \mu(BD) - u_0 \quad \text{or} \quad u = \lambda'(AB) + \mu'(BD) + (B) + u_0;$$

that is, for those which terminate at an unspecified one of the two points P or P' ,

$$u = \lambda(AB) + \mu(BD) \pm u_0 \quad \text{or} \quad u = \lambda'(AB) + \mu'(BD) + (B) \pm u_0.$$

Now amongst those solutions which restore to the independent variable either the value z or the value $-z$, some arrive at P or at P' with the value $+\sqrt{1-z^2}$ and some with the value $-\sqrt{1-z^2}$ for $\chi(u)$, and similarly with the values $+\sqrt{1-k^2z^2}$ or $-\sqrt{1-k^2z^2}$ for $\psi(u)$; and those solutions which arrive with the values $-\sqrt{1-z^2}$, $-\sqrt{1-k^2z^2}$ must be removed. To do this in the case $\chi(u) \equiv \sqrt{1-z^2}$ it is only necessary to select those cases in which the number of single loopings of B or of D must be even; that is, λ must be even and λ' must be odd. And in the case of $\psi(u) \equiv \sqrt{1-k^2z^2}$ we must select those cases in which the number of single loopings of A or of C must be even; that is, λ and λ' must both be even.

Thus for $\sqrt{1-z^2}$ the form of u is

$$u = 2m(2iK') + \mu 4K \pm u_0 \quad \text{or} \quad u = (2m' + 1)(2iK') + \mu' 4K + 2K \pm u_0,$$

in which the coefficients of $2iK'$ and $2K$ are both even or both

odd, *i.e.* in one expression $u = p(2iK' + 2K) + q4K \pm u_0$, where p and q are integers; and for $\sqrt{1 - k^2z^2}$ the form of u is

$$u = 2m(2iK') + \mu 4K \pm u_0 \quad \text{or} \quad u = 2m'(2iK') + \mu' 4K + 2K \pm u_0,$$

i.e., in one expression, $u = 4piK' + 2qK \pm u_0$, where p and q are integers.

Thus $\sqrt{1 - z^2} \equiv \chi(u) = \chi\{p(2iK' + 2K) + q4K \pm u_0\}$
 and $\sqrt{1 - k^2z^2} \equiv \psi(u) = \psi\{4piK' + 2qK \pm u_0\}.$

The functions ϕ , χ , ψ are plainly sn, cn and dn respectively. Thus

$$\left. \begin{aligned} \text{sn } v &= \text{sn}(2piK' + 2qK + (-1)^v v), & \text{with periods } 2iK', 4K, \\ \text{cn } v &= \text{cn}(p(2iK' + 2K) + q4K \pm v), & \text{with periods } 2iK' + 2K, 4K, \\ \text{dn } v &= \text{dn}(4piK' + 2qK \pm v), & \text{with periods } 4iK', 2K. \end{aligned} \right\}$$

Each function will have returned to its original value when the 'argument' has been increased by any multiple of $4iK'$ or of $4K$, which are therefore the whole periods for the group of functions, though individuals of the group will each have twice performed the whole cycle of their values in these intervals.

1342. We may examine this periodicity of $\text{cn } u$ and $\text{dn } u$ from a somewhat different point of view. Defining $\text{cn } u$ as $+\sqrt{1 - z^2}$ and $\text{dn } u$ as $+\sqrt{1 - k^2z^2}$, and noting that $z = +1$ are the only branch-points of $\sqrt{1 - z^2}$ and $z = +\frac{1}{k}$ are the only branch-points of $\sqrt{1 - k^2z^2}$, so that an odd number of loopings of B or D would change the branch of $\sqrt{1 - z^2}$, whilst an odd number of loopings of A or C would change the branch of $\sqrt{1 - k^2z^2}$, and remembering that

$$(A) = 2(K + iK'), \quad (B) = 2K, \quad (C) = -2(K + iK'), \quad (D) = -2K,$$

we have $\text{cn}[u + (A)] = \text{cn } u, \quad \text{cn}[u + (B)] = -\text{cn } u,$
 and $\therefore \text{cn}[u + 2(K + iK')] = \text{cn } u; \quad \text{and} \quad \text{cn}(u + 2K) = -\text{cn } u;$
 whence $\text{cn}(u + 4K) = -\text{cn}(u + 2K) = \text{cn } u.$

Therefore $2(K + iK')$ and $4K$ are periods of $\text{cn } u$, and

$$\begin{aligned} \text{cn}[u + 2\lambda(K + iK') + 4\mu K] &= \text{cn } u, \\ \text{cn}[u + 2\lambda(K + iK') + 2\mu K] &= -\text{cn } u \quad (\mu \text{ odd}); \\ \text{i.e.} \quad \text{cn}[u + 2\lambda iK' + 2(\lambda + \mu)K] &= -\text{cn } u \quad (\mu \text{ odd}), \\ \text{cn}[u + 2\lambda iK' + 2(\lambda + \mu)K] &= \text{cn } u \quad (\mu \text{ even}). \end{aligned}$$

Similarly $\text{dn}[u + (A)] = -\text{dn } u, \quad \text{dn}[u + (B)] = \text{dn } u,$

i.e. $\text{dn}(u + 2K) = \text{dn } u; \quad \text{and} \quad \text{dn}[u + 2(K + iK')] = -\text{dn } u;$
 whence $\text{dn}[u + 4(K + iK')] = -\text{dn}[u + 2(K + iK')] = \text{dn } u.$

Further, $\operatorname{dn}(u + 2iK') = \operatorname{dn}(u + 2K + 2iK') = -\operatorname{dn} u,$

$\operatorname{dn}(u + 4iK') = -\operatorname{dn}(u + 2iK') = \operatorname{dn} u,$ etc.,

i.e. $\operatorname{dn}(u + 2\lambda K + 1\mu iK') = \operatorname{dn} u$; $\operatorname{dn}(u + 2\lambda K + 2\mu iK') = -\operatorname{dn} u$ if μ be odd.

We may sum up these results concisely thus :

$$\left. \begin{aligned} \operatorname{sn}(u + 2piK' + 2qK) &= (-1)^q \operatorname{sn} u, \\ \operatorname{cn}(u + 2piK' + 2qK) &= (-1)^{p+q} \operatorname{cn} u, \\ \operatorname{dn}(u + 2piK' + 2qK) &= (-1)^p \operatorname{dn} u. \end{aligned} \right\}$$

1343. Values of $\operatorname{sn} iu, \operatorname{cn} iu, \operatorname{dn} iu.$

Let $iu = \int_0^\phi \frac{d\theta}{\sqrt{1 - k^2 \sin^2 \theta}}$, and put $\sin \theta = i \tan \phi$, an imaginary transformation. Then $\cos \theta d\theta = i \sec^2 \phi d\phi$ and $\cos \theta = \sec \phi$; then

$$iu = \int_0^\phi \frac{i \sec^2 \phi d\phi}{\sec \phi \sqrt{1 + k^2 \tan^2 \phi}} = i \int_0^\phi \frac{d\phi}{\sqrt{1 - k^2 \sin^2 \phi}};$$

$$\therefore \phi = \operatorname{am}(u, k'); \quad \therefore \operatorname{sn}(iu, k) = i \frac{\operatorname{sn}(u, k')}{\operatorname{cn}(u, k')};$$

whence $\operatorname{cn}(iu, k) = \frac{1}{\operatorname{cn}(u, k')}$; $\operatorname{dn}(iu, k) = \frac{\operatorname{dn}(u, k')}{\operatorname{cn}(u, k')}.$

These relations are true for all values of u real or complex.

1344. THE ADDITION FORMULAE FOR LEGENDRE'S FIRST INTEGRAL. EULER'S EQUATION.

Let $u_1 \equiv \int_0^{x_1} \frac{dz}{\sqrt{Z}}, u_2 \equiv \int_0^{x_2} \frac{dz}{\sqrt{Z}}$, where $Z = (1 - z^2)(1 - k^2 z^2).$

Then $x_1 = \operatorname{sn} u_1, \quad x_2 = \operatorname{sn} u_2.$

Consider the differential equation

$$\frac{dx_1}{\sqrt{X_1}} + \frac{dx_2}{\sqrt{X_2}} = 0, \dots\dots\dots(A)$$

where $X_1 \equiv (1 - x_1^2)(1 - k^2 x_1^2), \quad X_2 \equiv (1 - x_2^2)(1 - k^2 x_2^2).$

Let x_1 and x_2 be regarded as functions of a third variable t , such that

$$\dot{x}_1 \equiv \frac{dx_1}{dt} = \sqrt{X_1}; \quad \text{then} \quad \dot{x}_2 \equiv \frac{dx_2}{dt} = -\sqrt{X_2},$$

and $\dot{x}_1^2 = 1 - (k^2 + 1)x_1^2 + k^2 x_1^4; \quad \dot{x}_2^2 = 1 - (k^2 + 1)x_2^2 + k^2 x_2^4;$

whence, differentiating and dividing by $2\dot{x}_1$ and $2\dot{x}_2$ respectively, $\ddot{x}_1 = -(k^2 + 1)x_1 + 2k^2 x_1^3; \quad \ddot{x}_2 = -(k^2 + 1)x_2 + 2k^2 x_2^3;$

$$\left. \begin{aligned} \text{Thus} \quad \dot{x}_1 x_2 - \dot{x}_2 x_1 &= 2k^2(x_1^2 - x_2^2)x_1 x_2, \\ \text{whilst} \quad \dot{x}_1^2 x_2^2 - \dot{x}_2^2 x_1^2 &= -(x_1^2 - x_2^2)(1 - k^2 x_1^2 x_2^2) \end{aligned} \right\}$$

Hence
$$\frac{\dot{x}_1 x_2 - \dot{x}_2 x_1}{x_1 x_2 - \dot{x}_2 x_1} = -\frac{2k^2 x_1 x_2}{1 - k^2 x_1^2 x_2^2} \frac{d}{dt} (x_1 x_2);$$

whence $\log(x_1 x_2 - \dot{x}_2 x_1) = \log(1 - k^2 x_1^2 x_2^2) + \text{const.},$

i.e.
$$\frac{\dot{x}_1 x_2 - \dot{x}_2 x_1}{1 - k^2 x_1^2 x_2^2} = C, \quad \text{and} \quad \therefore \frac{x_2 \sqrt{X_1} + x_1 \sqrt{X_2}}{1 - k^2 x_1^2 x_2^2} = C.$$

Another form of the Integral of (A) is obviously

$$u_1 + u_2 = \int_0^{x_1} \frac{dr_1}{\sqrt{X_1}} + \int_0^{x_2} \frac{dr_2}{\sqrt{X_2}} = \text{const.} = C'.$$

It appears therefore that when $u_1 + u_2$ is constant, so also is

$$\frac{x_2 \sqrt{X_1} + x_1 \sqrt{X_2}}{1 - k^2 x_1^2 x_2^2} \text{ a constant.}$$

One of these constants must therefore be a function of the other, say, $C = \phi(C')$.

Hence $\frac{x_2 \sqrt{X_1} + x_1 \sqrt{X_2}}{1 - k^2 x_1^2 x_2^2} = \phi(u_1 + u_2)$, and the form of ϕ may be readily identified. For, since $u_1 = \int_0^{x_1} \frac{dz}{\sqrt{Z}}$ and $u_2 = \int_0^{x_2} \frac{dz}{\sqrt{Z}}$, it is clear that,

if $x_1 = 0$ and therefore $X_1 = 1$, we have $u_1 = 0$,

and if $x_2 = 0$ and therefore $X_2 = 1$, we have $u_2 = 0$.

Putting $u_2 = 0$, we have $\phi(u_1) \equiv x_1 = \text{sn } u_1$. Hence the form of the function ϕ is identified as the elliptic function sn . Thus we have

$$\text{sn}(u_1 + u_2) = \frac{x_2 \sqrt{1 - x_1^2} \sqrt{1 - k^2 x_1^2} + x_1 \sqrt{1 - x_2^2} \sqrt{1 - k^2 x_2^2}}{1 - k^2 x_1^2 x_2^2},$$

i.e.
$$\text{sn}(u_1 + u_2) = \frac{\text{sn } u_1 \text{ cn } u_2 \text{ dn } u_2 + \text{sn } u_2 \text{ cn } u_1 \text{ dn } u_1}{1 - k^2 \text{sn}^2 u_1 \text{sn}^2 u_2}.$$

Remembering that

$$\text{sn}' u_1, \text{ i.e. } \frac{d}{du_1} \text{sn } u_1, = \text{cn } u_1 \text{ dn } u_1 \quad \text{and} \quad \text{cn}' u_1 = -\text{sn } u_1 \text{ dn } u_1,$$

this formula may be written as

$$\text{sn}(u_1 + u_2) = \frac{\text{sn } u_1 \text{sn}' u_2 + \text{sn } u_2 \text{sn}' u_1}{1 - k^2 \text{sn}^2 u_1 \text{sn}^2 u_2}.$$

For shortness write $\text{sn } u_1 = s_1$, $\text{sn } u_2 = s_2$, $\text{cn } u_1 = c_1$, $\text{cn } u_2 = c_2$, $\text{dn } u_1 = d_1$, $\text{dn } u_2 = d_2$ and $1 - k^2 \text{sn}^2 u_1 \text{sn}^2 u_2 = D$.

Then $\text{sn}(u_1 + u_2) = (s_1 c_2 d_2 + s_2 c_1 d_1) / D$ or $= (s_1 s_2' + s_2 s_1') / D$.

[Compare the ordinary addition formula of trigonometry, $\sin(u_1 + u_2) = \sin u_1 \cos u_2 + \sin u_2 \cos u_1$, which may be similarly written $= s_1 c_2 + s_2 c_1$ or $= s_1 s_2' + s_2 s_1'$, viz. the case of the above elliptic function formula when $k=0$.]

1345. To obtain $\text{cn}(u_1 + u_2)$, we have

$$\begin{aligned} \text{cn}^2(u_1 + u_2) &= 1 - \text{sn}^2(u_1 + u_2) \\ &= \{(1 - k^2 s_1^2 s_2^2)^2 - (s_1 c_2 d_2 + s_2 c_1 d_1)^2\} / D^2 \\ &= (c_1^2 c_2^2 - 2s_1 s_2 c_1 c_2 d_1 d_2 + s_1^2 s_2^2 d_1^2 d_2^2) / D^2. \end{aligned}$$

$\therefore \text{cn}(u_1 + u_2) = (c_1 c_2 - s_1 s_2 d_1 d_2) / D$, the positive sign being taken because, when $u_2 = 0$, each side must become c_1 . This may be also written

$$\text{cn}(u_1 + u_2) = (c_1 c_2 - c_1' c_2') / D.$$

[Compare with the trigonometrical formula for $\cos(u_1 + u_2)$, which may be written $c_1 c_2 - s_1 s_2$ or $c_1 c_2 - c_1' c_2'$, where $c_1 = \cos u_1$, etc.]

1346. To obtain $\text{dn}(u_1 + u_2)$, we have

$$\begin{aligned} \text{dn}^2(u_1 + u_2) &= 1 - k^2 \text{sn}^2(u_1 + u_2) \\ &= \{(1 - k^2 s_1^2 s_2^2)^2 - k^2 (s_1 c_2 d_2 + s_2 c_1 d_1)^2\} / D^2 \\ &= (d_1^2 d_2^2 - 2k^2 s_1 s_2 c_1 c_2 d_1 d_2 + k^4 s_1^2 s_2^2 c_1^2 c_2^2) / D^2, \end{aligned}$$

and $\text{dn}(u_1 + u_2) = (d_1 d_2 - k^2 s_1 c_1 s_2 c_2) / D$, the positive sign being taken because, when $u_2 = 0$, each side must become d_1 . This may be written as

$$\text{dn}(u_1 + u_2) = \left(d_1 d_2 - \frac{1}{k^2} d_1' d_2' \right) / D.$$

1347. Derived Results.

From the three formulae

$$\left. \begin{aligned} \text{sn}(u_1 + u_2) &= (s_1 c_2 d_2 + s_2 c_1 d_1) / D, \\ \text{cn}(u_1 + u_2) &= (c_1 c_2 - s_1 s_2 d_1 d_2) / D, \\ \text{dn}(u_1 + u_2) &= (d_1 d_2 - k^2 s_1 s_2 c_1 c_2) / D, \end{aligned} \right\} \text{(I), we obtain, by changing} \\ \left. \begin{aligned} \text{sn}(u_1 - u_2) &= (s_1 c_2 d_2 - s_2 c_1 d_1) / D, \\ \text{cn}(u_1 - u_2) &= (c_1 c_2 + s_1 s_2 d_1 d_2) / D, \\ \text{dn}(u_1 - u_2) &= (d_1 d_2 + k^2 s_1 s_2 c_1 c_2) / D, \end{aligned} \right\} \text{(II).} \\ \text{the sign of } u_2,$$

The addition and subtraction of formulae (I) and (II) in pairs gives

$$\left. \begin{aligned} \operatorname{sn}(u_1 + u_2) + \operatorname{sn}(u_1 - u_2) &= 2s_1c_2d_2/D, \\ \operatorname{sn}(u_1 + u_2) - \operatorname{sn}(u_1 - u_2) &= 2s_2c_1d_1/D, \\ \operatorname{cn}(u_1 + u_2) + \operatorname{cn}(u_1 - u_2) &= 2c_1c_2/D, \\ \operatorname{cn}(u_1 + u_2) - \operatorname{cn}(u_1 - u_2) &= -2s_1s_2d_1d_2/D, \\ \operatorname{dn}(u_1 + u_2) + \operatorname{dn}(u_1 - u_2) &= 2d_1d_2/D, \\ \operatorname{dn}(u_1 + u_2) - \operatorname{dn}(u_1 - u_2) &= -2k^2s_1s_2c_1c_2/D, \end{aligned} \right\} \text{(III).}$$

Replacing $u_1 + u_2$ and $u_1 - u_2$ by U_1, U_2 respectively and writing D' for $1 - k^2 \operatorname{sn}^2 \frac{U_1 + U_2}{2} \operatorname{sn}^2 \frac{U_1 - U_2}{2}$, we have

$$\begin{aligned} \operatorname{sn} U_1 + \operatorname{sn} U_2 &= 2 \operatorname{sn} \frac{U_1 + U_2}{2} \operatorname{cn} \frac{U_1 - U_2}{2} \operatorname{dn} \frac{U_1 - U_2}{2} / D', \\ \operatorname{sn} U_1 - \operatorname{sn} U_2 &= 2 \operatorname{sn} \frac{U_1 - U_2}{2} \operatorname{cn} \frac{U_1 + U_2}{2} \operatorname{dn} \frac{U_1 + U_2}{2} / D', \\ \operatorname{cn} U_1 + \operatorname{cn} U_2 &= 2 \operatorname{cn} \frac{U_1 + U_2}{2} \operatorname{cn} \frac{U_1 - U_2}{2} / D', \\ \operatorname{cn} U_1 - \operatorname{cn} U_2 &= -2 \operatorname{sn} \frac{U_1 + U_2}{2} \operatorname{sn} \frac{U_1 - U_2}{2} \operatorname{dn} \frac{U_1 + U_2}{2} \operatorname{dn} \frac{U_1 - U_2}{2} / D', \\ \operatorname{dn} U_1 + \operatorname{dn} U_2 &= 2 \operatorname{dn} \frac{U_1 + U_2}{2} \operatorname{dn} \frac{U_1 - U_2}{2} / D', \\ \operatorname{dn} U_1 - \operatorname{dn} U_2 &= -2k^2 \operatorname{sn} \frac{U_1 + U_2}{2} \operatorname{sn} \frac{U_1 - U_2}{2} \operatorname{cn} \frac{U_1 + U_2}{2} \operatorname{cn} \frac{U_1 - U_2}{2} / D'. \end{aligned}$$

Again, by division of corresponding formulae from groups (I) and (II), and writing t_1 or $\operatorname{tn} u_1$ for $\tan \operatorname{am} u_1$ and $\operatorname{ctn} u_1$ for $\cot \operatorname{am} u_1$, etc.,

$$\left. \begin{aligned} \operatorname{tn}(u_1 \pm u_2) &= \frac{s_1c_2d_2 \pm s_2c_1d_1}{c_1c_2 \mp s_1s_2d_1d_2} = \frac{t_1d_2 \pm t_2d_1}{1 \mp t_1t_2d_1d_2}, \\ \operatorname{ctn}(u_1 \pm u_2) &= \frac{c_1c_2 \mp s_1s_2d_1d_2}{s_1c_2d_2 \pm s_2c_1d_1} = \frac{\operatorname{ctn} u_1 \operatorname{ctn} u_2 \mp \operatorname{dn} u_1 \operatorname{dn} u_2}{\operatorname{ctn} u_2 \operatorname{dn} u_2 \pm \operatorname{ctn} u_1 \operatorname{dn} u_1}. \end{aligned} \right\}$$

1348. Following Cayley's notation (*Elliptic Functions*, p. 62), with a slight modification, let us write

$$\begin{aligned} s_1s_2' &= A_1, & c_1c_2 &= B_1, & d_1d_2 &= C_1, \\ s_2s_1' &= A_2, & -c_1c_2' &= B_2, & -\frac{1}{k^2}d_1'd_2' &= C_2, & 1 - k^2s_1^2s_2^2 &= D, \\ P &= s_1^2 - s_2^2 = c_2^2 - c_1^2, \\ Q &= 1 - s_1^2 - s_2^2 + k^2s_1^2s_2^2 = c_1^2 - s_2^2d_1^2 = c_2^2 - s_1^2d_2^2, \\ R &= 1 - k^2s_1^2 - k^2s_2^2 + k^2s_1^2s_2^2 = d_1^2 - k^2s_2^2c_1^2 = d_2^2 - k^2s_1^2c_2^2, \\ s_1's_2' &= S_1, & -c_2c_1' &= T_1, & s_1c_1d_2 &= U_1, \\ -k^2s_1s_2 &= S_2, & c_1c_2' &= T_2, & s_2c_2d_1 &= U_2. \end{aligned}$$

A number of identical relations immediately arise amongst the capital letters. We have

$$(1) A_1^2 - A_2^2 = s_1^2 s_2^2 - s_2^2 s_1^2 = s_1^2(1 - s_2^2)(1 - k^2 s_2^2) - s_2^2(1 - s_1^2)(1 - k^2 s_1^2) \\ = (s_1^2 - s_2^2)(1 - k^2 s_1^2 s_2^2) = PD.$$

$$(2) B_1^2 - B_2^2 = c_1^2 c_2^2 - c_1^2 c_2^2 = (1 - s_1^2)(1 - s_2^2) - s_1^2 s_2^2(1 - k^2 s_1^2)(1 - k^2 s_2^2) \\ = (1 - s_1^2 - s_2^2 + k^2 s_1^2 s_2^2)(1 - k^2 s_1^2 s_2^2) = QD.$$

$$(3) C_1^2 - C_2^2 = d_1^2 d_2^2 - k^4 s_1^2 s_2^2 c_1^2 c_2^2 = (1 - k^2 s_1^2)(1 - k^2 s_2^2) - k^4 s_1^2 s_2^2(1 - s_1^2)(1 - s_2^2) \\ = (1 - k^2 s_1^2 - k^2 s_2^2 + k^2 s_1^2 s_2^2)(1 - k^2 s_1^2 s_2^2) = RD.$$

Hence
$$\frac{A_1^2 - A_2^2}{P} = \frac{B_1^2 - B_2^2}{Q} = \frac{C_1^2 - C_2^2}{R} = D.$$

Again,

$$(4) S_1^2 - S_2^2 = (1 - s_1^2)(1 - s_2^2)(1 - k^2 s_1^2)(1 - k^2 s_2^2) - (1 - k^2)^2 s_1^2 s_2^2 \\ = (1 - s_1^2 - s_2^2 + k^2 s_1^2 s_2^2)(1 - k^2 s_1^2 - k^2 s_2^2 + k^2 s_1^2 s_2^2) = QR.$$

$$(5) T_1^2 - T_2^2 = s_1^2(1 - k^2 s_1^2)(1 - s_2^2) - s_2^2(1 - k^2 s_2^2)(1 - s_1^2) \\ = (s_1^2 - s_2^2)(1 - k^2 s_1^2 - k^2 s_2^2 + k^2 s_1^2 s_2^2) = RP.$$

$$(6) U_1^2 - U_2^2 = s_1^2(1 - s_1^2)(1 - k^2 s_2^2) - s_2^2(1 - s_2^2)(1 - k^2 s_1^2) \\ = (s_1^2 - s_2^2)(1 - s_1^2 - s_2^2 + k^2 s_1^2 s_2^2) = PQ.$$

Hence
$$P(S_1^2 - S_2^2) = Q(T_1^2 - T_2^2) = R(U_1^2 - U_2^2) = PQR.$$

Also,

$$(7) (B_1 + B_2)(C_1 - C_2) = (c_1 c_2 - s_1 s_2 d_1 d_2)(d_1 d_2 + k^2 s_1 s_2 c_1 c_2) \\ = c_1 c_2 d_1 d_2 + k^2 s_1 s_2(1 - s_1^2 - s_2^2 + s_1^2 s_2^2) \\ - s_1 s_2(1 - k^2 s_1^2 - k^2 s_2^2 + k^4 s_1^2 s_2^2) - k^2 s_1^2 s_2^2 c_1 c_2 d_1 d_2 \\ = (c_1 c_2 d_1 d_2 - k^2 s_1 s_2)D = (S_1 + S_2)D,$$

and similarly, or changing the sign of s_2 ,

$$(B_1 - B_2)(C_1 + C_2) = (S_1 - S_2)D.$$

$$(8) (C_1 + C_2)(A_1 - A_2) = (d_1 d_2 - k^2 s_1 s_2 c_1 c_2)(c_1 c_2 d_2 - s_2 c_1 d_1) \\ = s_1 c_2 d_1(1 - k^2 s_2^2) - s_2 c_1 d_2(1 - k^2 s_1^2) \\ - s_1^2 s_2 c_1 k^2 d_2(1 - s_2^2) + s_1 s_2^2 c_2 k^2 d_1(1 - s_1^2) \\ = (s_1 c_2 d_1 - s_2 c_1 d_2)(1 - k^2 s_1^2 s_2^2) = (T_1 + T_2)D,$$

and similarly, or changing the sign of s_2 ,

$$(C_1 - C_2)(A_1 + A_2) = (T_1 - T_2)D.$$

$$(9) (A_1 + A_2)(B_1 - B_2) = (s_1 c_2 d_2 + s_2 c_1 d_1)(c_1 c_2 + s_1 s_2 d_1 d_2) \\ = s_1 c_1 d_2(1 - s_2^2) + s_2 c_2 d_1(1 - s_1^2) \\ + s_1^2 s_2 c_2 d_1(1 - k^2 s_2^2) + s_1 s_2^2 c_1 d_2(1 - k^2 s_1^2) \\ = (s_1 c_1 d_2 + s_2 c_2 d_1)(1 - k^2 s_1^2 s_2^2) = (U_1 + U_2)D,$$

and similarly, or changing the sign of s_2 ,

$$(A_1 - A_2)(B_1 + B_2) = (U_1 - U_2)D.$$

Thus

$$\frac{(B_1 \pm B_2)(C_1 \mp C_2)}{S_1 \pm S_2} = \frac{(C_1 \pm C_2)(A_1 \mp A_2)}{T_1 \pm T_2} = \frac{(A_1 \pm A_2)(B_1 \mp B_2)}{U_1 \pm U_2} = D.$$

With this notation, it follows at once that

$$\left. \begin{aligned} \operatorname{sn}(u_1 + u_2) &= \frac{A_1 + A_2}{D} = \frac{P}{A_1 - A_2} = \frac{U_1 + U_2}{B_1 - B_2} = \frac{T_1 - T_2}{C_1 - C_2}, \\ \operatorname{sn}(u_1 - u_2) &= \frac{A_1 - A_2}{D} = \frac{P}{A_1 + A_2} = \frac{U_1 - U_2}{B_1 + B_2} = \frac{T_1 + T_2}{C_1 + C_2}, \\ \operatorname{cn}(u_1 + u_2) &= \frac{B_1 + B_2}{D} = \frac{Q}{B_1 - B_2} = \frac{S_1 + S_2}{C_1 - C_2} = \frac{U_1 - U_2}{A_1 - A_2}, \\ \operatorname{cn}(u_1 - u_2) &= \frac{B_1 - B_2}{D} = \frac{Q}{B_1 + B_2} = \frac{S_1 - S_2}{C_1 + C_2} = \frac{U_1 + U_2}{A_1 + A_2}, \\ \operatorname{dn}(u_1 + u_2) &= \frac{C_1 + C_2}{D} = \frac{R}{C_1 - C_2} = \frac{T_1 + T_2}{A_1 - A_2} = \frac{S_1 - S_2}{B_1 - B_2}, \\ \operatorname{dn}(u_1 - u_2) &= \frac{C_1 - C_2}{D} = \frac{R}{C_1 + C_2} = \frac{T_1 - T_2}{A_1 + A_2} = \frac{S_1 + S_2}{B_1 + B_2}. \end{aligned} \right\}$$

1349. A number of identities immediately appear.

For example, since

$$(B_1 + B_2)(A_1 - A_2) = D(U_1 - U_2)$$

and

$$(B_1 - B_2)(A_1 + A_2) = D(U_1 + U_2),$$

we have

$$B_1 A_1 - B_2 A_2 = D U_1 \quad \text{and} \quad B_1 A_2 - B_2 A_1 = D U_2,$$

i.e.

$$s_1 s_2' \cdot c_1 c_2 + s_2 s_1' \cdot c_1' c_2' = s_1 c_1 d_2 (1 - k^2 s_1^2 s_2^2)$$

and

$$s_2 s_1' \cdot c_1 c_2 + s_1 s_2' \cdot c_1' c_2' = s_2 c_2 d_1 (1 - k^2 s_1^2 s_2^2).$$

1350. More important however than such, are the following :

$$\left. \begin{aligned} \operatorname{sn}(u_1 + u_2) + \operatorname{sn}(u_1 - u_2) &= \frac{2A_1}{D}, & \operatorname{sn}(u_1 + u_2) - \operatorname{sn}(u_1 - u_2) &= \frac{2A_2}{D}; \\ \operatorname{cn}(u_1 + u_2) + \operatorname{cn}(u_1 - u_2) &= \frac{2B_1}{D}, & \operatorname{cn}(u_1 + u_2) - \operatorname{cn}(u_1 - u_2) &= \frac{2B_2}{D}; \\ \operatorname{dn}(u_1 + u_2) + \operatorname{dn}(u_1 - u_2) &= \frac{2C_1}{D}, & \operatorname{dn}(u_1 + u_2) - \operatorname{dn}(u_1 - u_2) &= \frac{2C_2}{D}, \end{aligned} \right\}$$

which are the formulae of Group (III) in Cayley's notation.

$$\operatorname{sn}(u_1 + u_2) \operatorname{sn}(u_1 - u_2) = \frac{A_1^2 - A_2^2}{D^2} = \frac{PD}{D^2} = \frac{P}{D} = \frac{\operatorname{sn}^2 u_1 - \operatorname{sn}^2 u_2}{1 - k^2 \operatorname{sn}^2 u_1 \operatorname{sn}^2 u_2} \text{ or } (s_1^2 - s_2^2)/D,$$

$$\operatorname{cn}(u_1 + u_2) \operatorname{cn}(u_1 - u_2) = \frac{B_1^2 - B_2^2}{D^2} = \frac{QD}{D^2} = \frac{Q}{D} = \frac{\operatorname{cn}^2 u_1 - \operatorname{sn}^2 u_2 \operatorname{dn}^2 u_1}{1 - k^2 \operatorname{sn}^2 u_1 \operatorname{sn}^2 u_2} \text{ or } (c_1^2 - s_2^2 d_1^2)/D,$$

$$\operatorname{dn}(u_1 + u_2) \operatorname{dn}(u_1 - u_2) = \frac{C_1^2 - C_2^2}{D^2} = \frac{RD}{D^2} = \frac{R}{D} = \frac{\operatorname{dn}^2 u_1 - k^2 \operatorname{sn}^2 u_2 \operatorname{cn}^2 u_1}{1 - k^2 \operatorname{sn}^2 u_1 \operatorname{sn}^2 u_2} \text{ or } (d_1^2 - k^2 s_2^2 c_1^2)/D;$$

$$1 + \operatorname{sn}(u_1 + u_2) \operatorname{sn}(u_1 - u_2) = 1 + \frac{s_1^2 - s_2^2}{1 - k^2 s_1^2 s_2^2} = (c_2^2 + s_2^2 d_1^2)/D,$$

$$1 - \operatorname{sn}(u_1 + u_2) \operatorname{sn}(u_1 - u_2) = 1 - \frac{s_1^2 - s_2^2}{1 - k^2 s_1^2 s_2^2} = (c_1^2 + s_2^2 d_1^2)/D,$$

$$1 + k^2 \operatorname{sn}(u_1 + u_2) \operatorname{sn}(u_1 - u_2) = 1 + k^2 \frac{s_1^2 - s_2^2}{1 - k^2 s_1^2 s_2^2} = (d_2^2 + k^2 s_1^2 c_2^2)/D,$$

$$1 - k^2 \operatorname{sn}(u_1 + u_2) \operatorname{sn}(u_1 - u_2) = 1 - k^2 \frac{s_1^2 - s_2^2}{1 - k^2 s_1^2 s_2^2} = (d_1^2 + k^2 c_1^2 s_2^2)/D,$$

$$1 + \operatorname{cn}(u_1 + u_2) \operatorname{cn}(u_1 - u_2) = 1 + \frac{c_1^2 - s_2^2 d_1^2}{1 - k^2 s_1^2 s_2^2} = (c_1^2 + c_2^2)/D,$$

$$1 + \operatorname{dn}(u_1 + u_2) \operatorname{dn}(u_1 - u_2) = 1 + \frac{d_1^2 - k^2 s_2^2 c_1^2}{1 - k^2 s_1^2 s_2^2} = (d_1^2 + d_2^2)/D,$$

$$\begin{aligned} [1 + \operatorname{sn}(u_1 + u_2)][1 + \operatorname{sn}(u_1 - u_2)] &= \operatorname{sn}(u_1 + u_2) + \operatorname{sn}(u_1 - u_2) + [1 + \operatorname{sn}(u_1 + u_2) \operatorname{sn}(u_1 - u_2)] \\ &= (2s_1 c_2 d_2 + c_2^2 + s_1^2 d_2^2)/D = (c_2 + s_1 d_2)^2/D. \end{aligned}$$

$$\begin{aligned} \text{Again, } \operatorname{cn}(u_1 + u_2) \operatorname{dn}(u_1 - u_2) &= \frac{B_1 + B_2}{D} \cdot \frac{C_1 - C_2}{D} = \frac{S_1 + S_2}{D} \\ &= (s_1' s_2' - k^2 s_1 s_2)/D = (c_1 c_2 d_1 d_2 - k^2 s_1 s_2)/D, \end{aligned}$$

$$\begin{aligned} \operatorname{dn}(u_1 + u_2) \operatorname{sn}(u_1 - u_2) &= \frac{C_1 + C_2}{D} \cdot \frac{A_1 - A_2}{D} = \frac{T_1 + T_2}{D} = (c_1 c_2' - c_2 c_1')/D \\ &= (c_2 s_1 d_1 - c_1 s_2 d_2)/D, \end{aligned}$$

$$\operatorname{sn}(u_1 + u_2) \operatorname{cn}(u_1 - u_2) = \frac{A_1 + A_2}{D} \cdot \frac{B_1 - B_2}{D} = \frac{U_1 + U_2}{D} = (s_1 c_1 d_2 + s_2 c_2 d_1)/D,$$

and so on for other cases.

Jacobi gives a list of 33 such results (*Fundamenta Nova*, pp. 32-34). These are quoted by Cayley (*Elliptic Functions*, pp. 65 and 66) and by Greenhill (*Elliptic Functions*, pp. 138, 139).

Several have been worked above as illustrative of the method to be followed. They are too numerous to remember, but any one of them may be readily obtained if wanted. This list we append as Examples.

EXAMPLES. (JACOBI.)

1351. In each case the denominator $D = 1 - k^2 s_1^2 s_2^2$, and the previous notation is adhered to, viz. $\operatorname{sn} u_1 = s_1$, $\operatorname{sn} u_2 = s_2$, etc.

Establish the results following :

1. $\operatorname{sn}(u_1 + u_2) + \operatorname{sn}(u_1 - u_2) = 2s_1 c_2 d_2/D.$
2. $\operatorname{sn}(u_1 + u_2) - \operatorname{sn}(u_1 - u_2) = 2s_2 c_1 d_1/D.$
3. $\operatorname{cn}(u_1 + u_2) + \operatorname{cn}(u_1 - u_2) = 2c_1 c_2/D.$
4. $\operatorname{cn}(u_1 + u_2) - \operatorname{cn}(u_1 - u_2) = -2s_1 s_2 d_1 d_2/D.$
5. $\operatorname{dn}(u_1 + u_2) + \operatorname{dn}(u_1 - u_2) = 2d_1 d_2/D.$
6. $\operatorname{dn}(u_1 + u_2) - \operatorname{dn}(u_1 - u_2) = -2k^2 s_1 s_2 c_1 c_2/D.$
7. $\operatorname{sn}(u_1 + u_2) \operatorname{sn}(u_1 - u_2) = (s_1^2 - s_2^2)/D.$
8. $1 + \operatorname{sn}(u_1 + u_2) \operatorname{sn}(u_1 - u_2) = (c_2^2 + s_1^2 d_2^2)/D.$
9. $1 - \operatorname{sn}(u_1 + u_2) \operatorname{sn}(u_1 - u_2) = (c_1^2 + s_2^2 d_1^2)/D.$
10. $1 + k^2 \operatorname{sn}(u_1 + u_2) \operatorname{sn}(u_1 - u_2) = (d_2^2 + k^2 s_1^2 c_2^2)/D.$
11. $1 - k^2 \operatorname{sn}(u_1 + u_2) \operatorname{sn}(u_1 - u_2) = (d_1^2 + k^2 s_2^2 c_1^2)/D.$
12. $1 + \operatorname{cn}(u_1 + u_2) \operatorname{cn}(u_1 - u_2) = (c_1^2 + c_2^2)/D.$
13. $1 - \operatorname{cn}(u_1 + u_2) \operatorname{cn}(u_1 - u_2) = (s_1^2 d_2^2 + s_2^2 d_1^2)/D.$

14. $1 + \operatorname{dn}(u_1 + u_2) \operatorname{dn}(u_1 - u_2) = (d_1^2 + d_2^2)/D.$
15. $1 - \operatorname{dn}(u_1 + u_2) \operatorname{dn}(u_1 - u_2) = k^2(s_1^2 c_2^2 + s_2^2 c_1^2)/D.$
16. $\{1 \pm \operatorname{sn}(u_1 + u_2)\} \{1 \pm \operatorname{sn}(u_1 - u_2)\} = (c_2 \pm s_1 d_2)^2/D.$
17. $\{1 \pm \operatorname{sn}(u_1 + u_2)\} \{1 \mp \operatorname{sn}(u_1 - u_2)\} = (c_1 \pm s_2 d_1)^2/D.$
18. $\{1 \pm k \operatorname{sn}(u_1 + u_2)\} \{1 \pm k \operatorname{sn}(u_1 - u_2)\} = (d_2 \pm k s_1 c_2)^2/D.$
19. $\{1 \pm k \operatorname{sn}(u_1 + u_2)\} \{1 \mp k \operatorname{sn}(u_1 - u_2)\} = (d_1 \pm k s_2 c_1)^2/D.$
20. $\{1 \pm \operatorname{cn}(u_1 + u_2)\} \{1 \pm \operatorname{cn}(u_1 - u_2)\} = (c_1 \pm c_2)^2/D.$
21. $\{1 \pm \operatorname{cn}(u_1 + u_2)\} \{1 \mp \operatorname{cn}(u_1 - u_2)\} = (s_1 d_2 \mp s_2 d_1)^2/D.$
22. $\{1 \pm \operatorname{dn}(u_1 + u_2)\} \{1 \pm \operatorname{dn}(u_1 - u_2)\} = (d_1 \pm d_2)^2/D.$
23. $\{1 \pm \operatorname{dn}(u_1 + u_2)\} \{1 \mp \operatorname{dn}(u_1 - u_2)\} = k^2(s_1 c_2 \mp s_2 c_1)^2/D.$
24. $\operatorname{sn}(u_1 + u_2) \operatorname{cn}(u_1 - u_2) = (s_1 c_1 d_2 + s_2 c_2 d_1)/D.$
25. $\operatorname{sn}(u_1 - u_2) \operatorname{cn}(u_1 + u_2) = (s_1 c_1 d_2 - s_2 c_2 d_1)/D.$
26. $\operatorname{sn}(u_1 + u_2) \operatorname{dn}(u_1 - u_2) = (s_1 d_1 c_2 + s_2 d_2 c_1)/D.$
27. $\operatorname{sn}(u_1 - u_2) \operatorname{dn}(u_1 + u_2) = (s_1 d_1 c_2 - s_2 d_2 c_1)/D.$
28. $\operatorname{cn}(u_1 + u_2) \operatorname{dn}(u_1 - u_2) = (c_1 c_2 d_1 d_2 - k^2 s_1 s_2)/D.$
29. $\operatorname{cn}(u_1 - u_2) \operatorname{dn}(u_1 + u_2) = (c_1 c_2 d_1 d_2 + k^2 s_1 s_2)/D.$
30. $\sin \{ \operatorname{am}(u_1 + u_2) + \operatorname{am}(u_1 - u_2) \} = 2s_1 c_1 d_2/D.$
31. $\sin \{ \operatorname{am}(u_1 + u_2) - \operatorname{am}(u_1 - u_2) \} = 2s_2 c_2 d_1/D.$
32. $\cos \{ \operatorname{am}(u_1 + u_2) + \operatorname{am}(u_1 - u_2) \} = (c_1^2 - s_1^2 d_2^2)/D.$
33. $\cos \{ \operatorname{am}(u_1 + u_2) - \operatorname{am}(u_1 - u_2) \} = (c_2^2 - s_2^2 d_1^2)/D.$

To the above list it is convenient to add for reference :

- (a) $\operatorname{cn}(u_1 + u_2) \operatorname{cn}(u_1 - u_2) = (c_2^2 - s_1^2 d_2^2)/D = (c_1^2 - s_2^2 d_1^2)/D.$
- (b) $\operatorname{dn}(u_1 + u_2) \operatorname{dn}(u_1 - u_2) = (d_1^2 - k^2 s_1^2 c_1^2)/D = (d_2^2 - k^2 s_2^2 c_2^2)/D.$
- (c) $\{ \operatorname{dn}(u_1 + u_2) \pm \operatorname{cn}(u_1 + u_2) \} \{ \operatorname{dn}(u_1 - u_2) \pm \operatorname{cn}(u_1 - u_2) \} = (c_1 d_2 \pm c_2 d_1)^2/D.$
- (d) $\{ \operatorname{dn}(u_1 + u_2) \pm \operatorname{cn}(u_1 + u_2) \} \{ \operatorname{dn}(u_1 - u_2) \mp \operatorname{cn}(u_1 - u_2) \} = k^2 (s_1 \mp s_2)^2/D.$

[(c) and (d) are given by Greenhill, *E.F.*, p. 262.]

1352. Periodicity of the Functions considered by aid of the Addition Theorem.

Starting with the addition formulae in which $D \equiv 1 - k^2 s_1^2 s_2^2,$

$$\operatorname{sn}(u_1 \pm u_2) = (s_1 c_2 d_2 \pm s_2 c_1 d_1)/D; \quad \operatorname{cn}(u_1 \pm u_2) = (c_1 c_2 \mp s_1 s_2 d_1 d_2)/D;$$

$$\operatorname{dn}(u_1 \pm u_2) = (d_1 d_2 \mp k^2 s_1 s_2 c_1 c_2)/D;$$

and putting $u_1 = u, u_2 = K,$ we have, since $\operatorname{sn} K = 1, \operatorname{cn} K = 0, \operatorname{dn} K = k',$

$$\operatorname{sn}(u + K) = (\operatorname{sn} u \operatorname{cn} K \operatorname{dn} K + \operatorname{sn} K \operatorname{cn} u \operatorname{dn} u)/D,$$

where $D = 1 - k^2 \operatorname{sn}^2 u = \operatorname{dn}^2 u = d^2,$

$$\text{i.e.} \quad \left. \begin{aligned} \operatorname{sn}(u + K) &= \frac{c}{d}, & \operatorname{cn}(u + K) &= -\frac{k's}{d}, & \operatorname{dn}(u + K) &= \frac{k'}{d}, \\ \operatorname{sn}(u - K) &= -\frac{c}{d}, & \operatorname{cn}(u - K) &= \frac{k's}{d}, & \operatorname{dn}(u - K) &= \frac{k'}{d}. \end{aligned} \right\}$$

Putting $u + K$ in these formulæ in place of u ,

$$\left. \begin{aligned} \operatorname{sn}(u + 2K) &= \frac{\operatorname{cn}(u + K)}{\operatorname{dn}(u + K)} = -s, & \operatorname{cn}(u + 2K) &= -c, & \operatorname{dn}(u + 2K) &= d, \\ \operatorname{sn}(u + 3K) &= \frac{\operatorname{cn}(u + 2K)}{\operatorname{dn}(u + 2K)} = -\frac{c}{d}, & \operatorname{cn}(u + 3K) &= \frac{k's}{d}, & \operatorname{dn}(u + 3K) &= \frac{k'}{d}, \\ \operatorname{sn}(u + 4K) &= \frac{\operatorname{cn}(u + 3K)}{\operatorname{dn}(u + 3K)} = s, & \operatorname{cn}(u + 4K) &= c, & \operatorname{dn}(u + 4K) &= d. \end{aligned} \right\}$$

Hence the functions have all returned to their original values with period $4K$. It will be noted that $\operatorname{dn} u$ was restored with two additions of K , and that $\operatorname{sn} u$ and $\operatorname{cn} u$ took the same value but the opposite sign after two additions of K .

In the same way, since

$$\operatorname{sn}(K + iK') = \frac{1}{k}, \quad \operatorname{cn}(K + iK') = -\frac{ik'}{k}, \quad \operatorname{dn}(K + iK') = 0,$$

we have $\operatorname{sn}(u + K + iK') = \frac{1}{k} \cdot cd/D$, where $D = 1 - k'^2 s^2$, $\frac{1}{k^2} = c^2$;

$$\left. \begin{aligned} \therefore \operatorname{sn}(u + K + iK') &= \frac{d}{kc}, & \operatorname{cn}(u + K + iK') &= -\frac{ik'}{kc}, & \operatorname{dn}(u + K + iK') &= \frac{ik's}{c}, \\ \operatorname{sn}(u + 2K + 2iK') &= -s, & \operatorname{cn}(u + 2K + 2iK') &= c, & \operatorname{dn}(u + 2K + 2iK') &= -d, \\ \operatorname{sn}(u + 3K + 3iK') &= -\frac{d}{kc}, & \operatorname{cn}(u + 3K + 3iK') &= -\frac{ik'}{kc}, & \operatorname{dn}(u + 3K + 3iK') &= -\frac{ik's}{c}, \\ \operatorname{sn}(u + 4K + 4iK') &= s, & \operatorname{cn}(u + 4K + 4iK') &= c, & \operatorname{dn}(u + 4K + 4iK') &= d, \end{aligned} \right\}$$

and all the original values are again acquired after an addition of $4(K + iK')$, and it will be noted that after two additions of $K + iK'$, $\operatorname{cn} u$ resumed its original value, but $\operatorname{sn} u$ and $\operatorname{dn} u$ resumed their original values with the opposite sign.

Writing $u - K$ for u in the several cases of the last form,

$$\left. \begin{aligned} \operatorname{sn}(u + iK') &= \frac{\operatorname{dn}(u - K)}{k \operatorname{cn}(u - K)} = \frac{1}{ks}, & \operatorname{cn}(u + iK') &= -\frac{ud}{ks}, & \operatorname{dn}(u + iK') &= -\frac{ic}{s}, \\ \operatorname{sn}(u + K + 2iK') &= -\operatorname{sn}(u - K) = \frac{c}{d}, & \operatorname{cn}(u + K + 2iK') &= \frac{k's}{d}, & \operatorname{dn}(u + K + 2iK') &= -\frac{k'}{d}, \\ \operatorname{sn}(u + 2K + 3iK') &= -\frac{1}{ks}, & \operatorname{cn}(u + 2K + 3iK') &= -\frac{ud}{ks}, & \operatorname{dn}(u + 2K + 3iK') &= \frac{ic}{s}, \\ \operatorname{sn}(u + 3K + 4iK') &= \operatorname{sn}(u - K) = -\frac{c}{d}, & \operatorname{cn}(u + 3K + 4iK') &= \frac{k's}{d}, & \operatorname{dn}(u + 3K + 4iK') &= \frac{k'}{d}, \end{aligned} \right\}$$

the last three being the same results as for the functions of $u + 3K$.

Again, writing $u - K$ for u ,

$$\left. \begin{aligned} \operatorname{sn}(u + 2iK') &= \frac{\operatorname{cn}(u - K)}{\operatorname{dn}(u - K)} = s, & \operatorname{cn}(u + 2iK') &= -c, & \operatorname{dn}(u + 2iK') &= -d, \\ \operatorname{sn}(u + K + 3iK') &= \frac{d}{kc}, & \operatorname{cn}(u + K + 3iK') &= \frac{ik'}{kc}, & \operatorname{dn}(u + K + 3iK') &= -\frac{ik's}{c}, \\ \operatorname{sn}(u + 3iK') &= \frac{1}{k} \frac{\operatorname{dn}(u - K)}{\operatorname{cn}(u - K)} = \frac{1}{ks}, & \operatorname{cn}(u + 3iK') &= \frac{ud}{ks}, & \operatorname{dn}(u + 3iK') &= \frac{ic}{s}. \end{aligned} \right\}$$

Writing $u + K$ for u in the functions of $u + K + iK'$,

$$\left. \begin{aligned} \operatorname{sn}(u + 2K + iK') &= \frac{1 \operatorname{dn}(u + K)}{k \operatorname{cn}(u + K)} = -\frac{1}{ks}, & \operatorname{cn}(u + 2K + iK') &= \frac{id}{ks}, & \operatorname{dn}(u + 2K + iK') &= -\frac{ic}{s}, \\ \operatorname{sn}(u + 3K + iK') &= -\frac{1}{k} \frac{1}{\operatorname{sn}(u + K)} = -\frac{1}{kc}, & \operatorname{cn}(u + 3K + iK') &= \frac{ik'}{kc}, & \operatorname{dn}(u + 3K + iK') &= \frac{ik's}{c}. \end{aligned} \right\}$$

Writing $u + K$ for u in the functions of $u + 2K + 2iK'$,

$$\operatorname{sn}(u + 3K + 2iK') = -\operatorname{sn}(u + K) = -\frac{c}{d}, \quad \operatorname{cn}(u + 3K + 2iK') = -\frac{k's}{d}, \quad \operatorname{dn}(u + 3K + 2iK') = -\frac{k'}{d}.$$

1353. We exhibit these results for arguments of form $u + pK + q'iK'$, in tabular form for reference.

If Δ stand for the word denominator we have, tabulating the numerators only and indicating the several denominators,

	$+0.K$	$+K$	$+2K$	$+3K$	$+4K$
$+0.iK'$	$\begin{matrix} s \\ c \\ d \\ \Delta=1 \end{matrix}$	$\begin{matrix} c \\ -k's \\ k' \\ \Delta=d \end{matrix}$	$\begin{matrix} -s \\ -c \\ d \\ \Delta=1 \end{matrix}$	$\begin{matrix} -c \\ k's \\ k' \\ \Delta=d \end{matrix}$	$\begin{matrix} s \\ c \\ d \\ \Delta=1 \end{matrix}$
$+iK'$	$\begin{matrix} 1 \\ -id \\ -ikc \\ \Delta=ks \end{matrix}$	$\begin{matrix} d \\ -ik' \\ ikk'e \\ \Delta=kc \end{matrix}$	$\begin{matrix} -1 \\ id \\ -ikc \\ \Delta=ks \end{matrix}$	$\begin{matrix} -d \\ ik' \\ ikk's \\ \Delta=kc \end{matrix}$	$\begin{matrix} 1 \\ -id \\ -ikc \\ \Delta=ks \end{matrix}$
$+2iK'$	$\begin{matrix} s \\ -c \\ -d \\ \Delta=1 \end{matrix}$	$\begin{matrix} c \\ k's \\ -k' \\ \Delta=d \end{matrix}$	$\begin{matrix} -s \\ c \\ -d \\ \Delta=1 \end{matrix}$	$\begin{matrix} -c \\ -k's \\ -k' \\ \Delta=d \end{matrix}$	$\begin{matrix} s \\ -c \\ -d \\ \Delta=1 \end{matrix}$
$+3iK'$	$\begin{matrix} 1 \\ id \\ ikc \\ \Delta=ks \end{matrix}$	$\begin{matrix} d \\ ik' \\ -ikk's \\ \Delta=kc \end{matrix}$	$\begin{matrix} -1 \\ -id \\ ikc \\ \Delta=ks \end{matrix}$	$\begin{matrix} -d \\ -ik' \\ -ikk's \\ \Delta=kc \end{matrix}$	$\begin{matrix} 1 \\ id \\ ikc \\ \Delta=ks \end{matrix}$
$+4iK'$	$\begin{matrix} s \\ c \\ d \\ \Delta=1 \end{matrix}$	$\begin{matrix} c \\ -k's \\ k' \\ \Delta=d \end{matrix}$	$\begin{matrix} -s \\ -c \\ d \\ \Delta=1 \end{matrix}$	$\begin{matrix} -c \\ k's \\ k' \\ \Delta=d \end{matrix}$	$\begin{matrix} s \\ c \\ d \\ \Delta=1 \end{matrix}$

If, for instance, $\operatorname{dn}(u + 2K + 3iK')$ be required, we look in the group of the third column and fourth row and find numerator = ikc , denominator = ks , and the result is $i \operatorname{cn} u / \operatorname{sn} u$.

The vertical order in each square is $\operatorname{sn}(\quad)$, $\operatorname{cn}(\quad)$, $\operatorname{dn}(\quad)$, Δ .

The fifth column and fifth row exhibit the fact, that after an addition of $4K$ or of $4iK'$ to the argument, each of the functions returns to its original value, and shows their double periodicity. The value of any function of the forms

$$\operatorname{sn}(u + pK + q'iK'), \quad \operatorname{cn}(u + pK + q'iK'), \quad \operatorname{dn}(u + pK + q'iK'),$$

where p and q are integral, can now be written down; e.g.

$$\operatorname{cn}(u+5K+11iK') = \operatorname{cn}(u+K+3iK') = ik'/kc.$$

The tabulation is given by Cayley (*E.F.*, p. 77) with a slightly different notation.

1354. Putting $u=0$, all the functions in the table for which $\Delta=ks$ become infinite.

There are four such groups, i.e. twelve of the functions. Cayley points out the importance of their ratios even when themselves infinite, and writing I for the infinite factor $1/k \operatorname{sn} 0$ we have, remembering that $c=1$ and $d=1$, in this case

$$\begin{aligned} \frac{\operatorname{sn} iK'}{1} &= \frac{\operatorname{cn} iK'}{-i} = \frac{\operatorname{dn} iK'}{-ik} = \frac{\operatorname{sn}(2K+iK')}{-1} = \frac{\operatorname{cn}(2K+iK')}{i} = \frac{\operatorname{dn}(2K+iK')}{-ik} \\ &= \frac{\operatorname{sn} 3iK'}{1} = \frac{\operatorname{cn} 3iK'}{i} = \frac{\operatorname{dn} 3iK'}{ik} = \frac{\operatorname{sn}(2K+3iK')}{-1} = \frac{\operatorname{cn}(2K+3iK')}{-i} = \frac{\operatorname{dn}(2K+3iK')}{ik} = I. \end{aligned}$$

1355. Formula for $\sin 2u$, etc. Duplication Formulae.

Putting $u_1=u_2=u$ in the addition formulae and writing s, c, d, D respectively for $\sin u, \cos u, \operatorname{dn} u$ and $1-k^2 \operatorname{sn}^2 u$,

$$\begin{aligned} (1) \operatorname{sn} 2u &= 2scd/D, & (2) \operatorname{cn} 2u &= (c^2 - s^2 d^2)/D = (1 - 2s^2 + k^2 s^4)/D, \\ (3) \operatorname{dn} 2u &= (d^2 - k^2 s^2 c^2)/D = (1 - 2k^2 s^2 + k^2 s^4)/D. \end{aligned}$$

Hence we deduce, writing $t \equiv \operatorname{tn} u \equiv \operatorname{sn} u/\operatorname{cn} u$,

$$(4) 1 + \operatorname{cn} 2u = 2c^2/D, \quad (5) 1 - \operatorname{cn} 2u = 2s^2 d^2/D,$$

$$(6) \frac{1 - \operatorname{cn} 2u}{1 + \operatorname{cn} 2u} = t^2 d^2, \quad (7) \operatorname{cn} 2u = \frac{1 - t^2 d^2}{1 + t^2 d^2},$$

$$(8) 1 + \operatorname{dn} 2u = 2d^2/D, \quad (9) 1 - \operatorname{dn} 2u = 2k^2 s^2 c^2/D,$$

$$(10) \frac{1 - \operatorname{dn} 2u}{1 + \operatorname{dn} 2u} = \frac{k^2 s^2 c^2}{d^2}, \quad (11) \operatorname{dn} 2u = \frac{d^2 - k^2 s^2 c^2}{d^2 + k^2 s^2 c^2},$$

$$(12) \frac{1 - \operatorname{dn} 2u}{1 + \operatorname{cn} 2u} = k^2 s^2, \quad \therefore d^2 = 1 - k^2 s^2 = \frac{\operatorname{cn} 2u + \operatorname{dn} 2u}{1 + \operatorname{cn} 2u},$$

$$(13) \frac{1 + \operatorname{cn} 2u}{1 + \operatorname{dn} 2u} = \frac{c^2}{d^2}, \quad (14) 1 - k^2 \frac{1 + \operatorname{cn} 2u}{1 + \operatorname{dn} 2u} = 1 - \frac{k^2 c^2}{d^2} = \frac{k^2}{d^2},$$

$$\text{i.e. } \frac{k^2 + \operatorname{dn} 2u - k^2 \operatorname{cn} 2u}{1 + \operatorname{dn} 2u} = \frac{k^2}{d^2},$$

$$(15) 1 - k^2 \frac{1 - \operatorname{cn} 2u}{1 + \operatorname{dn} 2u} = 1 - k^2 s^2 = d^2, \quad \text{i.e. } \frac{k^2 + \operatorname{dn} 2u + k^2 \operatorname{cn} 2u}{1 + \operatorname{dn} 2u} = d^2,$$

$$(16) \operatorname{cn} 2u + \operatorname{dn} 2u = 2c^2 d^2/D \quad \text{and} \quad \frac{\operatorname{cn} 2u + \operatorname{dn} 2u}{1 + \operatorname{dn} 2u} = c^2.$$

(17) From (15) and (16),

$$\frac{\operatorname{sn}^2 u}{1 - \operatorname{cn} 2u} = \frac{\operatorname{cn}^2 u}{\operatorname{cn} 2u + \operatorname{dn} 2u} = \frac{\operatorname{dn}^2 u}{k^2 + \operatorname{dn} 2u + k^2 \operatorname{cn} 2u} = \frac{1}{1 + \operatorname{dn} 2u}.$$

1356. **Dimidiation Formulæ.**

By writing $\frac{u}{2}$ for u , we have

$$\operatorname{sn}^2 \frac{u}{2} = \frac{1 - \operatorname{cn} u}{1 + \operatorname{dn} u}, \quad \operatorname{cn}^2 \frac{u}{2} = \frac{\operatorname{cn} u + \operatorname{dn} u}{1 + \operatorname{dn} u}, \quad \operatorname{dn}^2 \frac{u}{2} = \frac{k^2 + \operatorname{dn} u + k^2 \operatorname{cn} u}{1 + \operatorname{dn} u}.$$

1357. Again, since

$$\operatorname{dn} 2u - \operatorname{cn} 2u = 2k^2 s^2 / D, \quad 1 + \operatorname{cn} 2u = 2c^2 / D, \quad 1 + \operatorname{dn} 2u = 2d^2 / D, \\ k^2 + \operatorname{dn} 2u - k^2 \operatorname{cn} 2u = 2k^2 / D,$$

we have $\frac{k^2 s^2}{\operatorname{dn} 2u - \operatorname{cn} 2u} = \frac{c^2}{1 + \operatorname{cn} 2u} = \frac{d^2}{1 + \operatorname{dn} 2u} = \frac{k^2}{k^2 + \operatorname{dn} 2u - k^2 \operatorname{cn} 2u},$

and putting $\frac{u}{2}$ for u , we obtain further formulæ for $\operatorname{sn} \frac{u}{2}$, $\operatorname{cn} \frac{u}{2}$, $\operatorname{dn} \frac{u}{2}$, viz.

$$\operatorname{sn}^2 \frac{u}{2} = \frac{\operatorname{dn} u - \operatorname{cn} u}{k^2 + \operatorname{dn} u - k^2 \operatorname{cn} u}, \quad \operatorname{cn}^2 \frac{u}{2} = \frac{k^2 (1 + \operatorname{cn} u)}{k^2 + \operatorname{dn} u - k^2 \operatorname{cn} u}, \quad \operatorname{dn}^2 \frac{u}{2} = \frac{k^2 (1 + \operatorname{dn} u)}{k^2 + \operatorname{dn} u - k^2 \operatorname{cn} u}.$$

1358. **Triplikation Formulæ.**

Writing $u_1 = u$, $u_2 = 2u$ in the addition formula for $\operatorname{sn}(u_1 + u_2)$,

$$\operatorname{sn} 3u = (\operatorname{sn} u \operatorname{cn} 2u \operatorname{dn} 2u + \operatorname{sn} 2u \operatorname{cn} u \operatorname{dn} u) (1 - k^2 \operatorname{sn}^2 u \operatorname{sn}^2 2u),$$

and substituting for $\operatorname{sn} 2u$, $\operatorname{cn} 2u$, $\operatorname{dn} 2u$ their values from (1), (2), (3) of Art 1355, we obtain, after a little reduction,

$$\operatorname{sn} 3u / \operatorname{sn} u = \{3 - 4(1 + k^2)s^2 + 6k^2s^4 - k^4s^6\} / D',$$

and similarly $\operatorname{cn} 3u, \operatorname{cn} u = \{1 - 4s^2 + 6k^2s^4 - 4k^4s^6 + k^4s^8\} / D',$

$$\operatorname{dn} 3u / \operatorname{dn} u = \{1 - 4k^2s^2 + 6k^2s^4 - 4k^4s^6 + k^4s^8\} / D',$$

where $D' = 1 - 6k^2s^4 + 4k^2(1 + k^2)s^6 - 3k^4s^8.$

Cayley gives also the following results, which may be verified without difficulty :

$$\frac{1 - \operatorname{sn} 3u}{1 + \operatorname{sn} u} \cdot D' = (1 - 2s + 2k^2s^3 - k^2s^4)^2; \quad \frac{1 + \operatorname{sn} 3u}{1 - \operatorname{sn} u} \cdot D' = (1 + 2s - 2k^2s^3 - k^2s^4)^2;$$

$$\frac{1 - k \operatorname{sn} 3u}{1 + k \operatorname{sn} u} \cdot D' = (1 - 2ks + 2ks^3 - k^2s^4)^2; \quad \frac{1 + k \operatorname{sn} 3u}{1 - k \operatorname{sn} u} \cdot D' = (1 + 2ks - 2ks^3 - k^2s^4)^2.$$

The formulæ for $\operatorname{sn} \lambda u$, $\operatorname{cn} \lambda u$, $\operatorname{dn} \lambda u$ for the cases $\lambda = 4, 5, 6$ and 7 are also given by Cayley (*Ell. F.*, pp 78 and 81 onwards), but these formulæ rapidly become more and more complicated. According to Cayley the cases $\lambda = 6$ and $\lambda = 7$ are due to Baehr (*Grunert's Archiv*, xxxvi. pp. 125 to 176).

1359. **Dimidiation Formulæ for the Periods.**

$$\operatorname{sn}^2 \frac{u}{2} = \frac{1 - \operatorname{cn} u}{1 + \operatorname{dn} u}, \quad \operatorname{cn}^2 \frac{u}{2} = \frac{\operatorname{cn} u + \operatorname{dn} u}{1 + \operatorname{dn} u}, \quad \operatorname{dn}^2 \frac{u}{2} = \frac{k^2 + \operatorname{dn} u + k^2 \operatorname{cn} u}{1 + \operatorname{dn} u},$$

give many results for the functions of $u + p \frac{K}{\omega} + q \frac{K'}{\omega}$, p and q being integers.

Putting $u=0$ in the formulae of the table, and therefore $s=0$, $c=1$, $d=1$,

$$\begin{aligned} \operatorname{sn} \frac{K}{2} &= \sqrt{\frac{1 - \operatorname{cn} K}{1 + \operatorname{dn} K}} = \frac{1}{\sqrt{1+k'}}; & \operatorname{cn} \frac{K}{2} &= \sqrt{\frac{\operatorname{cn} K + \operatorname{dn} K}{1 + \operatorname{dn} K}} = \frac{\sqrt{k'}}{\sqrt{1+k'}}; \\ \operatorname{dn} \frac{K}{2} &= \sqrt{\frac{k'^2 + \operatorname{dn} K + k^2 \operatorname{cn} K}{1 + \operatorname{dn} K}} = \sqrt{k'} \\ \operatorname{sn} \frac{iK'}{2} &= \sqrt{\frac{1 - \operatorname{cn} iK'}{1 + \operatorname{dn} iK'}} = \sqrt{\frac{1+iI}{1-ikI}} (I=\infty) = \sqrt{-\frac{1}{k}} = \frac{i}{\sqrt{k}}; \\ \operatorname{cn} \frac{iK'}{2} &= \sqrt{\frac{\operatorname{cn} iK' + \operatorname{dn} iK'}{1 + \operatorname{dn} iK'}} = \sqrt{\frac{-iI - ikI}{1-ikI}} (I=\infty) = \frac{\sqrt{1+k}}{\sqrt{k}}; \\ \operatorname{dn} \frac{iK'}{2} &= \sqrt{\frac{k'^2 + \operatorname{dn} iK' + k^2 \operatorname{cn} iK'}{1 + \operatorname{dn} iK'}} = \sqrt{\frac{k'^2 - ikI - k^2 I}{1-ikI}} (I=\infty) = \sqrt{1+k}. \end{aligned} \left. \vphantom{\begin{aligned} \operatorname{sn} \frac{iK'}{2} \\ \operatorname{cn} \frac{iK'}{2} \\ \operatorname{dn} \frac{iK'}{2} \end{aligned}} \right\}$$

$$\begin{aligned} \operatorname{sn} \frac{K+iK'}{2} &= \sqrt{\frac{1 - \operatorname{cn}(K+iK')}{1 + \operatorname{dn}(K+iK')}} = \frac{\sqrt{k'+ik'}}{\sqrt{k}} = \frac{1}{\sqrt{2k}} (\sqrt{1+k} + i\sqrt{1-k}); \\ \operatorname{cn} \frac{K+iK'}{2} &= \sqrt{\frac{\operatorname{cn}(K+iK') + \operatorname{dn}(K+iK')}{1 + \operatorname{dn}(K+iK')}} \\ &= \sqrt{-i \frac{k'}{k}} = \sqrt{\frac{k'}{k}} \left(\cos \frac{3\pi}{2} + i \sin \frac{3\pi}{2} \right)^{\frac{1}{2}} = \sqrt{\frac{k'}{2k}} (-1+i); \\ \operatorname{dn} \frac{K+iK'}{2} &= \sqrt{\frac{k'^2 + \operatorname{dn}(K+iK') + k^2 \operatorname{cn}(K+iK')}{1 + \operatorname{dn}(K+iK')}} \\ &= \sqrt{k'} \sqrt{k' - ik} = \sqrt{\frac{k'}{2}} [\sqrt{1+k} - i\sqrt{1-k}]. \end{aligned}$$

The reader will find no difficulty in completing for himself and tabulating the various results for the cases $p=0, 1, 2, 3$; $q=0, 1, 2, 3$. Such a table is given by Cayley (*E.F.*, p. 74).

1360. We now have

$$\begin{aligned} \operatorname{sn} \left(u + \frac{K}{2} \right) &= \frac{s \sqrt{\frac{k'}{1+k'}} \cdot \sqrt{k'} + \frac{1}{\sqrt{1+k'}} cd}{1 - k^2 s^2 \frac{1}{1+k'}} = \frac{1}{\sqrt{1+k'}} \frac{k's + cd}{c^2 + k's^2}; \\ \operatorname{cn} \left(u + \frac{K}{2} \right) &= \frac{c \sqrt{\frac{k'}{1+k'}} - sd \frac{1}{\sqrt{1+k'}} \sqrt{k'}}{1 - k^2 s^2 \frac{1}{1+k'}} = \sqrt{\frac{k'}{1+k'}} \frac{c - sd}{c^2 + k's^2}; \\ \operatorname{dn} \left(u + \frac{K}{2} \right) &= \frac{d \sqrt{k'} - k^2 s \frac{1}{\sqrt{1+k'}} c \frac{\sqrt{k'}}{\sqrt{1+k'}}}{1 - k^2 s^2 \frac{1}{1+k'}} = \sqrt{k'} \frac{d - (1-k')sc}{c^2 + k's^2}, \end{aligned}$$

with many similar results, and such results may be thrown into other forms. For example, we may show that

$$\operatorname{sn} \left(u + \frac{K}{2} \right) = \frac{1}{\sqrt{1+k'}} \frac{d + sc(1+k')}{c + sd}, \quad \operatorname{cn} \left(u + \frac{K}{2} \right) = \sqrt{\frac{k'}{1+k'}} \frac{c^2 - k's^2}{c + sd}.$$

1361. Other formulæ may be obtained by direct application of the dimidiary formulæ to the results for $2u + pK + qK'$, e.g.

$$\operatorname{sn}(2u + K) = \frac{\operatorname{cn} 2u}{\operatorname{dn} 2u}, \quad \operatorname{cn}(2u + K) = -k' \frac{\operatorname{sn} 2u}{\operatorname{dn} 2u}, \quad \operatorname{dn}(2u + K) = \frac{k'}{\operatorname{dn} 2u};$$

whence
$$\operatorname{sn}^2\left(u + \frac{K}{2}\right) = \frac{1 - \operatorname{cn}(2u + K)}{1 + \operatorname{dn}(2u + K)} = \frac{\operatorname{dn} 2u + k' \operatorname{sn} 2u}{\operatorname{dn} 2u + k'}, \text{ etc.,}$$

and many other formulæ are similarly obtainable.

1362. **A General Proposition.**

Let U be a function of three variables ϕ_1, ϕ_2, ϕ_3 , between which there is a connecting relation, viz.

$$d\phi_1/\Delta\phi_1 + d\phi_2/\Delta\phi_2 + d\phi_3/\Delta\phi_3 = 0,$$

and suppose the function U to be such that when any one of the three, say ϕ_3 , is regarded as a constant, then U vanishes in one of the two cases ($\phi_1 = \phi_3, \phi_2 = 0$) or ($\phi_2 = \phi_3, \phi_1 = 0$), and provided also that $\frac{\partial U}{\partial \phi_1} \Delta\phi_1 = \frac{\partial U}{\partial \phi_2} \Delta\phi_2$, then U must be zero always.

For if $\phi_3 = \text{const.}$, $d\phi_3 = 0$ and $d\phi_1/\Delta\phi_1 + d\phi_2/\Delta\phi_2 = 0$, i.e. $d\phi_1/\Delta\phi_1 = -d\phi_2/\Delta\phi_2 = \lambda$, say, and this would have been equally true if the connecting equation were

$$d\phi_1/\Delta\phi_1 + d\phi_2/\Delta\phi_2 - d\phi_3/\Delta\phi_3 = 0.$$

But

$$dU = \frac{\partial U}{\partial \phi_1} d\phi_1 + \frac{\partial U}{\partial \phi_2} d\phi_2 + \frac{\partial U}{\partial \phi_3} d\phi_3 = \lambda \left[\frac{\partial U}{\partial \phi_1} \Delta\phi_1 - \frac{\partial U}{\partial \phi_2} \Delta\phi_2 \right] = 0;$$

$\therefore U = \text{const.} = C$, say. But in the case ($\phi_1 = \phi_3, \phi_2 = 0$), $U = 0$; $\therefore C = 0$. Therefore U vanishes.

1363. Case I. Let

$$u_1 = \int_0^{\phi_1} \frac{d\theta}{\Delta\theta}, \quad u_2 = \int_0^{\phi_2} \frac{d\theta}{\Delta\theta}, \quad u_3 = \int_0^{\phi_3} \frac{d\theta}{\Delta\theta} \quad \text{and} \quad U \equiv u_1 + u_2 - u_3.$$

Then
$$\frac{\partial U}{\partial u_1} = 1, \quad \frac{\partial U}{\partial u_2} = 1, \quad \frac{\partial u_1}{\partial \phi_1} = \frac{1}{\Delta\phi_1}, \quad \frac{\partial u_2}{\partial \phi_2} = \frac{1}{\Delta\phi_2},$$

and
$$\frac{\partial U}{\partial \phi_1} \Delta\phi_1 - \frac{\partial U}{\partial \phi_2} \Delta\phi_2 = 1 - 1 = 0.$$

Also, if $\phi_1 = \phi_3$ and $\phi_2 = 0$, we have $u_1 = u_3$ and $u_2 = 0$, i.e. $u_1 + u_2 - u_3 = 0$. Hence the conditions of the general theorem are satisfied, and $u_1 + u_2 - u_3 = 0$ always, i.e. according to

Legendre's notation $F\phi_1 + F\phi_2 = F\phi_3$, which is the addition formula for the first Legendrian Integral.

That is, $F(\text{am } u_1) + F(\text{am } u_2) = F(\text{am } u_3)$.

Another mode of treatment (Art. 1342) of the equation $d\phi_1/\Delta\phi_1 + d\phi_2/\Delta\phi_2 = 0$ led to the result that

$$\frac{\text{sn } u_1 \text{ cn } u_2 \text{ dn } u_2 + \text{sn } u_2 \text{ cn } u_1 \text{ dn } u_1}{1 - k^2 \text{sn}^2 u_1 \text{sn}^2 u_2} = \text{const.}$$

when $\phi_3 = \text{const.}$, so that $u_3 = \text{const.}$; and as $(u_1 = u_3, u_2 = 0)$ satisfies this, the constant is $\text{sn } u_3$, so that

$$u_1 + u_2 = \text{sn}^{-1} \frac{s_1 c_2 d_2 + s_2 c_1 d_1}{1 - k^2 s_1^2 s_2^2}, \text{ as before.}$$

1364. Case II. With the same definition of u_1, u_2, u_3 , and taking

$$v_1 = \int_0^{\phi_1} \Delta\theta \, d\theta, \quad v_2 = \int_0^{\phi_2} \Delta\theta \, d\theta, \quad v_3 = \int_0^{\phi_3} \Delta\theta \, d\theta,$$

and $U \equiv v_1 + v_2 - v_3 - k^2 \sin \phi_1 \sin \phi_2 \sin \phi_3$, then, proceeding as before,

$$\begin{aligned} \frac{\partial U}{\partial \phi_1} \Delta\phi_1 - \frac{\partial U}{\partial \phi_2} \Delta\phi_2 &= \Delta\phi_1 [\Delta\phi_1 - k^2 \cos \phi_1 \sin \phi_2 \sin \phi_3] \\ &\quad - \Delta\phi_2 [\Delta\phi_2 - k^2 \cos \phi_2 \sin \phi_1 \sin \phi_3] \\ &= (\Delta\phi_1)^2 - (\Delta\phi_2)^2 - k^2 \sin \phi_3 [\Delta\phi_1 \cos \phi_1 \sin \phi_2 - \Delta\phi_2 \cos \phi_2 \sin \phi_1] \\ &= (1 - k^2 s_1^2) - (1 - k^2 s_2^2) - k^2 \frac{s_1 c_2 d_2 + s_2 c_1 d_1}{1 - k^2 s_1^2 s_2^2} (s_2 c_1 d_1 - s_1 c_2 d_2) \\ &= k^2 [(s_2^2 - s_1^2)(1 - k^2 s_1^2 s_2^2) + s_1^2 (1 - s_2^2)(1 - k^2 s_2^2) \\ &\quad - s_2^2 (1 - s_1^2)(1 - k^2 s_1^2)] / (1 - k^2 s_1^2 s_2^2) \\ &= 0. \end{aligned}$$

Also, if $\phi_2 = 0, v_2 = 0$ and if $\phi_1 = \phi_3, v_1 = v_3$, and $\therefore U = 0$ in this case; $\therefore U = 0$ always, and

$$\therefore v_1 + v_2 - v_3 = k^2 \sin \phi_1 \sin \phi_2 \sin \phi_3;$$

and writing $v_1 = E\phi_1, v_2 = E\phi_2, v_3 = E\phi_3$, viz. the Legendrian notation, $E\phi_1 + E\phi_2 - E\phi_3 = k^2 \sin \phi_1 \sin \phi_2 \sin \phi_3$;

and since $\phi_1 = \text{am } u_1, \phi_2 = \text{am } u_2, \phi_3 = \text{am } u_3 = \text{am } (u_1 + u_2)$, we have

$$E \text{ am } u_1 + E \text{ am } u_2 - E \text{ am } (u_1 + u_2) = k^2 \text{sn } u_1 \text{sn } u_2 \text{sn } (u_1 + u_2),$$

which constitutes the addition formula for the second class of Legendrian Elliptic Integrals.

1365. Case III. Let

$$w_1 = \int_0^{\phi_1} \frac{d\theta}{(1+n \sin^2 \theta) \Delta \theta}, \quad w_2 = \text{etc.}, \quad w_3 = \text{etc.},$$

where $\phi_1 = am u_1$, etc. Then, putting

$$U = w_1 + w_2 - w_3 - \int \frac{dR}{1+aR^2}, \quad an = (n+1)(n+k^2),$$

$$R = \frac{n \sin \phi_1 \sin \phi_2 \sin \phi_3}{1+n-n \cos \phi_1 \cos \phi_2 \cos \phi_3},$$

we may verify as before by the general theorem that $U=0$, i.e.

$$\Pi \phi_1 + \Pi \phi_2 - \Pi \phi_3 = \frac{1}{\sqrt{a}} \tan^{-1} R \sqrt{a} \quad \text{or} \quad \frac{1}{\sqrt{-a}} \tanh^{-1} R \sqrt{-a},$$

which is the addition formula for a Legendrian Integral of the third class (see Cayley, *E.F.*, pp. 104 to 106).

The work of this verification is necessarily somewhat cumbrous, and it is found best to proceed to discuss the Third Legendrian Integral $\Pi(\theta, n, k)$ after a modification of its form.

Taking $\theta = am u$ as before, $\frac{du}{d\theta} = \frac{1}{\Delta \theta} = \frac{1}{dn u}$. Let $n = -k^2 sn^2 a$, a being not necessarily real; then the transformed integral is

$$\Pi(\theta, n, k) = \int_0^u \frac{du}{1 - k^2 sn^2 a sn^2 u}.$$

But instead of considering the original function $\Pi(\theta, n, k)$, it is convenient to consider a somewhat different form $\Pi(u, a)$,

defined as $\equiv \int_0^u \frac{k^2 sn a cn a dn a sn^2 u du}{1 - k^2 sn^2 a sn^2 u}$.

The connexion between $\Pi(u, a)$ and $\Pi(\theta, n, k)$ is then

$$\begin{aligned} \Pi(u, a) &= k^2 sn a cn a dn a \int_0^{\theta} \frac{\sin^2 \theta d\theta}{(1+n \sin^2 \theta) \Delta \theta} \\ &= \frac{k^2}{n} sn a cn a dn a \int_0^{\theta} \frac{(1+n \sin^2 \theta) - 1}{(1+n \sin^2 \theta) \Delta \theta} d\theta \\ &= \frac{k^2}{n} sn a cn a dn a \{F(\theta, k) - \Pi(\theta, n, k)\}, \end{aligned}$$

and the new function is proportional to the difference of the first and third Legendrian forms.

1366. **Jacobian Zeta, Eta, Theta Functions. Introductory.**

These functions, denoted respectively by $Z(u)$, $H(u)$, $\Theta(u)$, are defined as

$$Z(u) \equiv \int_0^u \left(\operatorname{dn}^2 u - \frac{E_1}{K} \right) du, \quad \frac{\Theta'(u)}{\Theta(u)} \equiv Z(u), \quad \frac{H(u)}{\Theta(u)} = \sqrt{k} \operatorname{sn} u$$

with a constant of integration in the second case, such that $\Theta(0) = \sqrt{\frac{2k'K}{\pi}}$, and k being the modulus in each case. Also

E_1 in the first of these Jacobian Elliptic Functions is the complete Legendrian Integral of the second kind with limits 0 and $\pi/2$ (Art. 375).

1367. **Obvious Elementary Properties.**

Clearly $Z(0) = 0$ and $Z(-u) = -Z(u)$.

Also $Z(u) + \frac{E_1}{K} u = \int_0^u \operatorname{dn}^2 u \, du = \int_0^\theta \Delta \theta \, d\theta = E(\theta) = E(\operatorname{am} u)$

in the Legendrian notation, i.e. $Z(u) = E(\operatorname{am} u) - \frac{E_1}{K} u$ in that notation.

Again

$$\Theta(u) = \sqrt{\frac{2k'K}{\pi}} e^{\int_0^u Z(u) \, du} \quad \text{and} \quad H(u) = \sqrt{\frac{2kk'K}{\pi}} \operatorname{sn} u e^{\int_0^u Z(u) \, du}$$

$$\begin{aligned} \text{Also } \Theta(-u) &= \sqrt{\frac{2k'K}{\pi}} e^{\int_0^{-u} Z(t) \, dt} = \sqrt{\frac{2k'K}{\pi}} e^{-\int_0^u Z(-w) \, dw} \quad (t = -w) \\ &= \sqrt{\frac{2k'K}{\pi}} e^{\int_0^u Z(w) \, dw} = \Theta(u), \end{aligned}$$

$$H(-u) = \sqrt{k} \operatorname{sn}(-u) \Theta(-u) = -\sqrt{k} \operatorname{sn} u \Theta(u) = -H(u).$$

$$\text{Also } H(0) = 0 \quad \text{and} \quad \lim_{u \rightarrow 0} \frac{H(u)}{u} = \sqrt{\frac{2kk'K}{\pi}}.$$

Thus $Z(u)$ and $H(u)$ are odd functions of u , and $\Theta(u)$ is an even function of u .

1368. **Properties of the Second Legendrian Integral.**

$$(i) \quad E(-\phi) = \int_0^{-\phi} \Delta \theta \, d\theta = -\int_0^\phi \Delta \chi \, d\chi, \quad (\theta = -\chi), = -E(\phi).$$

$$\begin{aligned} (ii) \quad E(\pi \pm \phi) &= \int_0^{\pi \pm \phi} \Delta \theta \, d\theta = \left(\int_0^\pi + \int_\pi^{\pi \pm \phi} \right) \Delta \theta \, d\theta \\ &= \left(\int_0^\pi + \int_0^\pm \phi \right) \Delta \chi \, d\chi, \quad (\theta = \pi + \chi \text{ in second}), = 2E_1 \pm E\phi. \end{aligned}$$

(iii) $E(2\pi \pm \phi) = 2E_1 + E(\pi \pm \phi) = 4E_1 \pm E(\phi)$, and generally
 $E(n\pi \pm \phi) = 2nE_1 \pm E(\phi)$, i.e. $E(n\pi \pm \operatorname{am} u) = 2nE_1 \pm E(\operatorname{am} u)$.

(iv) Again, with $u = \int_0^\theta \frac{d\phi}{\Delta\phi}$, $v = \int_0^\theta \Delta\phi d\phi$,
 $\theta = \operatorname{am} u$, $v = E(\operatorname{am} u)$,

and if $\theta = 0$, $u = 0$ and $v = 0$, i.e. $E(\operatorname{am} 0) = 0$; whilst if $\theta = \frac{\pi}{2}$,

$$u = F_1 \equiv K, \quad v = E_1, \quad \text{i.e. } E(\operatorname{am} K) = E_1.$$

(v) Moreover $E(\operatorname{am} u) + E(\operatorname{am} K) - E \operatorname{am}(u + K)$

$$= k^2 \operatorname{sn} u \sin \frac{\pi}{2} \operatorname{sn}(u + K) = k^2 \frac{\operatorname{sn} u \operatorname{cn} u}{\operatorname{dn} u};$$

$$\therefore E \operatorname{am}(u + K) = E(\operatorname{am} u) + E_1 - k^2 \frac{\operatorname{sn} u \operatorname{cn} u}{\operatorname{dn} u}.$$

$$\text{Also } -E \operatorname{am}(u - K) = -E(\operatorname{am} u) + E_1 + k^2 \frac{\operatorname{sn} u \operatorname{cn} u}{\operatorname{dn} u}.$$

1369. **Addition Formula for the Zeta Function, etc.**

The formulae for $\operatorname{dn}(u + v)$, $\operatorname{dn}(u - v)$ of Art. 1347 give

$$\operatorname{dn}^2(u + v) - \operatorname{dn}^2(u - v) = -4k^2 \frac{\operatorname{sn} u \operatorname{cn} u \operatorname{dn} u \operatorname{sn} v \operatorname{cn} v \operatorname{dn} v}{(1 - k^2 \operatorname{sn}^2 u \operatorname{sn}^2 v)^2};$$

and integrating with regard to v from $v = a$ to $v = u$,

$$\begin{aligned} & \left[Z(u + v) + \frac{E_1}{K}(u + v) \right]_{v=a}^{v=u} + \left[Z(u - v) + \frac{E_1}{K}(u - v) \right]_{v=a}^{v=u} \\ &= -\frac{2}{\operatorname{sn}^2 u} \left[\frac{\operatorname{sn} u \operatorname{cn} u \operatorname{dn} u}{1 - k^2 \operatorname{sn}^2 u \operatorname{sn}^2 v} \right]_{v=a}^{v=u}, \end{aligned}$$

$$\begin{aligned} \text{i.e.} \quad & \left\{ Z(2u) + \frac{E_1}{K} 2u - Z(u + a) - \frac{E_1}{K}(u + a) \right\} \\ & + \left\{ Z(0) + \frac{E_1}{K} \cdot 0 - Z(u - a) - \frac{E_1}{K}(u - a) \right\} \\ &= -\frac{2 \operatorname{sn} u \operatorname{cn} u \operatorname{dn} u}{\operatorname{sn}^2 u} \left(\frac{1}{1 - k^2 \operatorname{sn}^4 u} - \frac{1}{1 - k^2 \operatorname{sn}^2 a \operatorname{sn}^2 u} \right) \end{aligned}$$

$$= -2k^2 \frac{\operatorname{sn} u \operatorname{cn} u \operatorname{dn} u}{1 - k^2 \operatorname{sn}^2 u} \cdot \frac{\operatorname{sn}^2 u - \operatorname{sn}^2 a}{1 - k^2 \operatorname{sn}^2 a \operatorname{sn}^2 u}$$

$$= -k^2 \operatorname{sn} 2u \operatorname{sn}(u + a) \operatorname{sn}(u - a) \quad (\text{Arts. 1351 and 1355});$$

$$\therefore Z(u + a) + Z(u - a) - Z(2u) = k^2 \operatorname{sn} 2u \operatorname{sn}(u + a) \operatorname{sn}(u - a). \quad (\text{I})$$

Putting $a=0$, we have

$$Z(2u) - 2Z(u) = -k^2 \operatorname{sn} 2u \operatorname{sn}^2 u. \dots\dots\dots(\text{II})$$

Adding

$$Z(u+a) + Z(u-a) - 2Z(u) = k^2 \operatorname{sn} 2u \left\{ \frac{\operatorname{sn}^2 u - \operatorname{sn}^2 a}{1 - k^2 \operatorname{sn}^2 u \operatorname{sn}^2 a} - \operatorname{sn}^2 u \right\}$$

$$= -k^2 \operatorname{sn} 2u \frac{\operatorname{sn}^2 a (1 - k^2 \operatorname{sn}^4 u)}{1 - k^2 \operatorname{sn}^2 u \operatorname{sn}^2 a},$$

i.e. $Z(u+a) + Z(u-a) - 2Z(u) = -2k^2 \frac{\operatorname{sn} u \operatorname{cn} u \operatorname{dn} u \operatorname{sn}^2 a}{1 - k^2 \operatorname{sn}^2 a \operatorname{sn}^2 u}$; (III)

and writing $u+a=u_1$, $u-a=u_2$, $2u=u_1+u_2$, Eq. (I) becomes

$$Z(u_1+u_2) = Z(u_1) + Z(u_2) - k^2 \operatorname{sn} u_1 \operatorname{sn} u_2 \operatorname{sn}(u_1+u_2), \quad (\text{IV})$$

which constitutes an addition formula for the Zeta Function.

1370. Substituting for $Z(u)$ its value $E(\operatorname{am} u) - \frac{E_1}{K}u$, we have

$$E(\operatorname{am} u_1) + E(\operatorname{am} u_2) - E(\operatorname{am} \overline{u_1+u_2}) = k^2 \operatorname{sn} u_1 \operatorname{sn} u_2 \operatorname{sn}(u_1+u_2),$$

viz. the addition formula of the Second Legendrian Integral.

If in (IV) we write $u_1+u_2+u_3=0$, we have the symmetrical form

$$Z(u_1) + Z(u_2) + Z(u_3) = -k^2 \operatorname{sn} u_1 \operatorname{sn} u_2 \operatorname{sn} u_3.$$

1371. From (III), we have at once

$$\frac{\Theta'(u+a)}{\Theta(u+a)} + \frac{\Theta'(u-a)}{\Theta(u-a)} - 2 \frac{\Theta'(u)}{\Theta(u)} = -2k^2 \frac{\operatorname{sn} u \operatorname{cn} u \operatorname{dn} u \operatorname{sn}^2 a}{1 - k^2 \operatorname{sn}^2 u \operatorname{sn}^2 a},$$

i.e. $\left[\log \frac{\Theta(u+a)\Theta(u-a)}{\Theta^2(u)} \right]_{u=0}^{u-u} = \left[\log(1 - k^2 \operatorname{sn}^2 a \operatorname{sn}^2 u) \right]_0^u,$

i.e. $\frac{\Theta(u+a)\Theta(u-a)}{\Theta^2(a)\Theta^2(u)} \Theta^2(0) = 1 - k^2 \operatorname{sn}^2 a \operatorname{sn}^2 u. \dots\dots(\text{V})$

1372. If we integrate with regard to a , instead of with regard to u , from 0 to a ,

$$\log \frac{\Theta(a+u)}{\Theta(a-u)} - 2aZ(u) = -2\Pi(a, u). \dots\dots\dots(\text{VI})$$

and interchanging u and a ,

$$\log \frac{\Theta(u+a)}{\Theta(u-a)} - 2uZ(a) = -2\Pi(u, a), \dots\dots\dots(\text{VII})$$

i.e. $\Pi(u, a) = \log e^{uZ(a)} \left\{ \frac{\Theta(u-a)}{\Theta(u+a)} \right\}^{\frac{1}{2}},$

which expresses the Legendrian Integral of the Third Kind in terms of the Jacobian Zeta and Theta functions.

There are in this form two arguments only, viz. u and a , instead of the three, θ , k , u , in the Legendrian form (see Greenhill, *E.F.*, p. 192).

1373. From (VI) and (VII),

$$\Pi(u, a) - \Pi(a, u) = uZ(a) - aZ(u). \dots\dots\dots(\text{VIII})$$

Since $\Pi(u_1, a) = u_1Z(a) + \frac{1}{2} \log \frac{\Theta(u_1 - a)}{\Theta(u_1 + a)},$

$$\Pi(u_2, a) = u_2Z(a) + \frac{1}{2} \log \frac{\Theta(u_2 - a)}{\Theta(u_2 + a)},$$

and $\Pi(u_1 + u_2, a) = (u_1 + u_2)Z(a) + \frac{1}{2} \log \frac{\Theta(u_1 + u_2 - a)}{\Theta(u_1 + u_2 + a)},$

we have $\Pi(u_1, a) + \Pi(u_2, a) - \Pi(u_1 + u_2, a) = \frac{1}{2} \log \Omega,$
 where $\Omega = \frac{\Theta(u_1 - a)\Theta(u_2 - a)\Theta(u_1 + u_2 + a)}{\Theta(u_1 + a)\Theta(u_2 + a)\Theta(u_1 + u_2 - a)},$ } (IX)

which is a form of the addition formula for the Third Legendrian Integral. Various forms of the function Ω will be found in Cayley, *E.F.*, pages 157, etc., and *The Messenger of Math.*, vol. x. (Glaisher).

1374. In this brief notice of these important functions, we have in the main followed the course suggested by Dr. Glaisher in his note in the *Proceedings of the Lond. Math. Soc.*, vol. xvii.

1375. **Integration of Expressions involving the Jacobian Functions.**

[We shall write s, c, d for $\text{sn } u, \text{cn } u, \text{dn } u$ respectively when desirable for abridgment.]

$$(1) \int \text{sn } u \, du = - \int \frac{d \text{cn } u}{\sqrt{1 - k^2 \text{sn}^2 u}} = - \int \frac{d \text{cn } u}{\sqrt{k'^2 + k^2 \text{cn}^2 u}} = - \frac{1}{k} \sinh^{-1} \frac{k \text{cn } u}{k'}$$

$$= - \frac{1}{k} \log \frac{\text{dn } u + k \text{cn } u}{k'} = \frac{1}{k} \log \sqrt{\frac{d - kc}{d + kc}}, \text{ or other forms.}$$

$$(2) \int \text{cn } u \, du = \int \frac{d \text{sn } u}{\sqrt{1 - k^2 \text{sn}^2 u}} = \frac{1}{k} \sin^{-1}(k \text{sn } u) = \frac{1}{k} \cos^{-1}(\text{dn } u), \text{ or other forms.}$$

$$(3) \int \text{dn } u \, du = \int d\theta = \theta = \text{am } u.$$

$$(4) \int \text{sn}^2 u \, du = \frac{1}{k^2} \int (1 - \text{dn}^2 u) \, du = \frac{1}{k^2} (u - E \text{am } u) = \frac{1}{k^2} \left\{ u - \left(Zu + \frac{E_1}{K} u \right) \right\}.$$

$$(5) \int \operatorname{cn}^2 u \, du = \frac{1}{k^2} \int (\operatorname{dn}^2 u - k'^2) \, du = \frac{1}{k^2} (E \operatorname{am} u - k'^2 u) = \frac{1}{k^2} \left\{ (Zu + \frac{E_1}{K} u) - k'^2 u \right\}.$$

$$(6) \int \operatorname{dn}^2 u \, du = E \operatorname{am} u = Zu + \frac{E_1}{K} u.$$

$$(7) \int \operatorname{sn}^3 u \, du = - \int \operatorname{sn}^2 u \frac{d(\operatorname{cn} u)}{\operatorname{dn} u} = - \int \frac{(1-c^2) dc}{\sqrt{k'^2 + k^2 c^2}} \\ = - \frac{1}{k^2} \int \frac{dc}{\sqrt{k'^2 + k^2 c^2}} + \frac{1}{k^2} \int \sqrt{k'^2 + k^2 c^2} \, dc = - \frac{1+k^2}{2k^3} \sinh^{-1} \frac{kc}{k'} + \frac{1}{2k^2} cd.$$

$$(8) \int \operatorname{cn}^3 u \, du = \int \frac{(1-s^2) ds}{\sqrt{1-k^2 s^2}} = \frac{1}{k^2} \int \left(\sqrt{1-k^2 s^2} - \sqrt{1-k^2 s^2} \right) ds \\ = \frac{1}{2k^2} sd + \frac{2k^2-1}{2k^3} \sin^{-1}(ks).$$

$$(9) \int \operatorname{dn}^3 u \, du = \int (1 - k^2 \sin^2 \theta) d\theta = \frac{2-k^2}{2} \theta + \frac{k^2}{4} \sin 2\theta = \frac{2-k^2}{2} \operatorname{am} u + \frac{k^2}{2} \operatorname{sn} u \operatorname{cn} u, \\ \text{etc.}$$

$$(10) \int \frac{du}{\operatorname{sn} u} = - \int \frac{dc}{(1-c^2)\sqrt{k'^2 + k^2 c^2}}, \text{ which suggests putting } y = \frac{d}{s}; \text{ whence}$$

$$dy = -\frac{c}{s^2} du, \quad s^2 = 1/(k^2 + y^2), \quad c^2 = (y^2 - k'^2)/(k^2 + y^2);$$

$$\therefore \int \frac{du}{\operatorname{sn} u} = - \int \frac{s}{c} dy = - \int \frac{dy}{\sqrt{y^2 - k'^2}} = - \cosh^{-1} \left(\frac{y}{k'} \right) = - \cosh^{-1} \left(\frac{\operatorname{dn} u}{k' \operatorname{sn} u} \right).$$

$$(11) \int \frac{du}{\operatorname{cn} u}. \quad \text{Putting } y = \frac{d}{c}, \quad dy = k'^2 \frac{s}{c^2} du, \quad s^2 = \frac{y^2-1}{y^2-k^2}, \quad c^2 = \frac{k'^2}{y^2-k^2};$$

$$\therefore \int \frac{du}{\operatorname{cn} u} = \frac{1}{k'^2} \int \frac{k'}{\sqrt{y^2-1}} dy = \frac{1}{k'} \cosh^{-1} y = \frac{1}{k'} \cosh^{-1} \left(\frac{\operatorname{dn} u}{\operatorname{cn} u} \right).$$

$$(12) \int \frac{du}{\operatorname{dn} u} = \int \frac{d\theta}{1-k^2 \sin^2 \theta} = \int \frac{\operatorname{cosec}^2 \theta \, d\theta}{\cot^2 \theta + k'^2} = \frac{1}{k'} \cot^{-1} \frac{\cot \theta}{k'} = \frac{1}{k'} \cot^{-1} \frac{\operatorname{cn} u}{k'}.$$

$$1376. \text{ Again } \frac{d^2}{du^2} \log \operatorname{sn} u = \frac{d}{du} \frac{cd}{s} = -d^2 - k^2 c^2 - \frac{c^2 d^2}{s^2} = k^2 s^2 - \frac{1}{s^2},$$

$$\frac{d^2}{du^2} \log \operatorname{cn} u = - \frac{d}{du} \frac{sd}{c} = -d^2 + k^2 s^2 - \frac{s^2 d^2}{c^2} = -k^2 c^2 - \frac{k'^2}{c^2},$$

$$\frac{d^2}{du^2} \log \operatorname{dn} u = -k^2 \frac{d}{du} \frac{sc}{d} = -k^2 c^2 + k^2 s^2 - k^4 \frac{s^2 c^2}{d^2} = d^2 - d^2.$$

$$\text{Hence } (13) \int \frac{du}{\operatorname{sn}^2 u} = - \frac{\operatorname{cn} u \operatorname{dn} u}{\operatorname{sn} u} + u - E \operatorname{am} u.$$

$$(14) \int \frac{du}{\operatorname{cn}^2 u} = \frac{1}{k'^2} \frac{\operatorname{sn} u \operatorname{dn} u}{\operatorname{cn} u} - \frac{1}{k'^2} (E \operatorname{am} u - k'^2 u).$$

$$(15) \int \frac{du}{\operatorname{dn}^2 u} = - \frac{k^2 \operatorname{sn} u \operatorname{cn} u}{\operatorname{dn} u} + \frac{1}{k^2} E \operatorname{am} u.$$

1377. Other positive or negative integral powers of $\text{sn } u$, $\text{cn } u$, $\text{dn } u$ may be integrated with regard to u by the reduction formulæ of Examples 24, 25, 26 at the end of the chapter, which can be verified at once by putting respectively $P = s^{n-1}cd$, $c^{n-1}sd$, $d^{n-1}sc$ and differentiating.

1378. Again, by aid of the Period formulæ of Art. 1352, viz.

$$\begin{aligned} \frac{c}{d} &= \text{sn}(u + K), & \frac{s}{d} &= -\frac{1}{k'} \text{cn}(u + K), & \frac{1}{d} &= \frac{1}{k'} \text{dn}(u + K), \\ \frac{1}{s} &= k \text{sn}(u + \iota K'), & \frac{d}{s} &= -\frac{k}{\iota} \text{cn}(u + \iota K'), & \frac{c}{s} &= -\frac{1}{\iota} \text{dn}(u + \iota K'), \\ \frac{d}{c} &= k \text{sn}(u + K + \iota K'), & \frac{1}{c} &= -\frac{k}{\iota k'} \text{cn}(u + K + \iota K'), & \frac{s}{c} &= \frac{1}{\iota k'} \text{dn}(u + K + \iota K'), \end{aligned}$$

we may readily deduce the integrals of integral powers of

$$\frac{c}{d}, \frac{d}{c}, \frac{s}{d}, \frac{d}{s}, \frac{c}{s}, \frac{s}{c}.$$

Thus, for example,

$$\begin{aligned} \int \frac{\text{cn}^2 u}{\text{dn}^2 u} du &= \int \text{sn}^2(u + K) du = \frac{1}{k^2} \{ (u + K) - E \text{am}(u + K) \} \\ &= \frac{1}{k^2} \left\{ u - E \text{am } u + k^2 \frac{\text{sn } u \text{ cn } u}{\text{dn } u} \right\} + \text{const.} \end{aligned}$$

1379. Again, since

$$\text{II}(u, a) = \int_0^u \frac{k^2 \text{sn}^2 u \text{ sn } a \text{ cn } a \text{ dn } a}{1 - k^2 \text{sn}^2 a \text{ sn}^2 u} du = \frac{\text{cn } a \text{ dn } a}{\text{sn } a} \int_0^u \left(\frac{1}{1 - k^2 \text{sn}^2 a \text{ sn}^2 u} - 1 \right) du,$$

we have
$$\int_0^u \frac{du}{1 - k^2 \text{sn}^2 a \text{ sn}^2 u} = \frac{\text{sn } a}{\text{cn } a \text{ dn } a} \text{II}(u, a) + u,$$

i.e.
$$\int_0^u \frac{du}{1 - k \text{sn } a \text{ sn } u} + \int_0^u \frac{du}{1 + k \text{sn } a \text{ sn } u} = 2 \left[\frac{\text{sn } a}{\text{cn } a \text{ dn } a} \text{II}(u, a) + u \right],$$

whilst

$$\begin{aligned} \int_0^u \frac{du}{1 - k \text{sn } a \text{ sn } u} - \int_0^u \frac{du}{1 + k \text{sn } a \text{ sn } u} &= \int_0^u \frac{2k \text{sn } a \text{ sn } u}{1 - k^2 \text{sn}^2 a \text{ sn}^2 u} du \\ &= \frac{k \text{sn } a}{\text{cn } a \text{ dn } a} \int_0^u (\text{sn } \bar{u} + a + \text{sn } \bar{u} - a) du, \end{aligned}$$

which is integrable by (1), Art. 1375 ; whence by addition and subtraction the two integrals

$$\int_0^u \frac{du}{1 - k \text{sn } a \text{ sn } u}, \quad \int_0^u \frac{du}{1 + k \text{sn } a \text{ sn } u} \quad \text{are determined.}$$

PROBLEMS.

1. Show that $\frac{d}{du} \frac{\operatorname{sn} u}{\operatorname{cn} u \operatorname{dn} u} = \frac{2}{\operatorname{cn} 2u + \operatorname{dn} 2u}$. [Ox. II. P., 1903.]

2. Prove that

(a) $\sqrt{(1 - k^2 \operatorname{sn}^4 u)(k' + \operatorname{dn} 2u)/\sqrt{1 + k'}} = 1 - (1 - k') \operatorname{sn}^2 u$;

(b) $\sqrt{(\operatorname{cn} 2u + ik' \operatorname{sn} 2u)(1 - k^2 \operatorname{sn}^4 u)} = ik' \operatorname{sn} u + \operatorname{cn} u \operatorname{dn} u$.

3. Prove that the equation of the osculating plane at the point u on the curve $x = a \operatorname{sn} u, y = b \operatorname{cn} u, z = c \operatorname{dn} u$ is

$\frac{x}{a} k^2 k'^2 \operatorname{sn}^3 u - \frac{y}{b} k^2 \operatorname{cn}^3 u + \frac{z}{c} \operatorname{dn}^3 u = k'^2$. [Ox. II. P., 1902.]

4. If $u = \int_0^x \{(a^2 + x^2)(b^2 + x^2)\}^{-\frac{1}{2}} dx$, show that

$x = b \operatorname{tn} u$, (mod. $\sqrt{a^2 - b^2/a}$), $a > b$. [Ox. II. P., 1902.]

5. If the functions $\operatorname{sn} u, \operatorname{cn} u, \operatorname{dn} u$ be defined by means of

$\frac{d}{du} \operatorname{sn} u = \operatorname{cn} u \operatorname{dn} u, \frac{d}{du} \operatorname{cn} u = -\operatorname{sn} u \operatorname{dn} u, \frac{d}{du} \operatorname{dn} u = -k^2 \operatorname{sn} u \operatorname{cn} u,$

$\operatorname{sn} 0 = 0, \operatorname{cn} 0 = 1, \operatorname{dn} 0 = 1,$

prove that (i) $\operatorname{dn}^2 u = 1 - k^2 \operatorname{sn}^2 u = 1 - k^2 + k^2 \operatorname{cn}^2 u$;

(ii) $\frac{\operatorname{sn} u \operatorname{cn} v + \operatorname{cn} u \operatorname{sn} v}{\operatorname{dn} u + \operatorname{dn} v}$ is a function of $u + v$.

[Ox. II. P., 1901.]

6. If $x\sqrt{2 - \sqrt{3}} = \cos \phi$ and the differential $\frac{dx}{\sqrt{1 + 2x^2\sqrt{3} - x^4}}$ is transformed into $\frac{a d\phi}{\sqrt{1 - \sin^2 a \sin^2 \phi}}$, find the values of a and a .

[CAYLEY, 1885.]

7. Prove the following results :

u	$\frac{K}{2}$	$\frac{3K}{2}$	$\frac{K + 2iK'}{2}$	$\frac{3K + 2iK'}{2}$	$\frac{iK'}{2}$	$\frac{2K + iK'}{2}$
$\operatorname{sn} u$	$\frac{1}{\sqrt{1+k'}}$	$\frac{1}{\sqrt{1+k'}}$	$\frac{1}{\sqrt{1-k'}}$	$\frac{1}{\sqrt{1-k'}}$	$\frac{i}{\sqrt{k}}$	$\frac{1}{\sqrt{k}}$
u	$\frac{3iK'}{2}$	$\frac{2K + 3iK'}{2}$	$\frac{K + iK'}{2}$	$\frac{3K + iK'}{2}$	$\frac{K + 3iK'}{2}$	$\frac{3K + 3iK'}{2}$
$\operatorname{sn} u$	$\frac{-i}{\sqrt{k}}$	$\frac{1}{\sqrt{k}}$	$\sqrt{\frac{k+i k'}{k}}$	$\sqrt{\frac{k-i k'}{k}}$	$\sqrt{\frac{k-i k'}{k}}$	$\sqrt{\frac{k+i k'}{k}}$

and find the values of $\operatorname{cn} u, \operatorname{dn} u$ in each case.

[See Table in CAYLEY, *E.F.*, p. 74.]

8. If $\tan \frac{1}{8}\pi \sin \phi = \sin \psi = x\sqrt{1-x^2}/\sqrt{1+x^2}$, prove that

$$\int_0^x \frac{dx}{\sqrt{1-x^2}} = \frac{1}{2\sqrt{2}} \int_0^\phi \frac{d\phi}{\sqrt{1-\tan^2 \frac{1}{8}\pi \sin^2 \phi}} + \sin^2 \frac{1}{8}\pi \int_0^\psi \frac{d\psi}{\sqrt{1-\tan^2 \frac{1}{8}\pi \sin^2 \psi}}.$$

[MATH. TRIP., 1896.]

9. Prove that $\operatorname{cn} \frac{1}{2}iK' \operatorname{dn} \frac{1}{2}iK' \div \operatorname{sn} \frac{1}{2}iK' = -i(1+\sqrt{k})\sqrt{1+k}$
and $\operatorname{dn} \frac{1}{2}iK' \div \operatorname{sn} \frac{1}{2}iK' \operatorname{cn} \frac{1}{2}iK' = -i\{1+\sqrt{1+k}\}\sqrt{k}$.
[MATH. TRIP., 1896.]

10. If $\operatorname{tn} u_1 = T_1 \operatorname{dn} u_1$, $\operatorname{tn} u_2 = T_2 \operatorname{dn} u_2$, $\operatorname{dn} u_1 = D_1^{-1}$, $\operatorname{dn} u_2 = D_2^{-1}$, show that

$$(i) \operatorname{tn} (u_1 + u_2) = \frac{T_1 + T_2}{D_1 D_2 - T_1 T_2}, \quad \text{and} \quad (ii) \operatorname{tn} 2u = \frac{2 \operatorname{tn} u \operatorname{dn} u}{1 - \operatorname{tn}^2 u \operatorname{dn}^2 u}.$$

11. Prove $\sin [\operatorname{am} (u+v) + \operatorname{am} (u-v)] = 2 \operatorname{sn} u \operatorname{cn} u \operatorname{dn} v / D$,
 $1 + \operatorname{dn} (u+v) \operatorname{dn} (u-v) = (\operatorname{dn}^2 u + \operatorname{dn}^2 v) / D$,

where $D = 1 - k^2 \operatorname{sn}^2 u \operatorname{sn}^2 v$.

Prove that

$$12. \operatorname{sn} \left(u + \frac{K'}{2} \right) = \frac{1}{\sqrt{1+k'}} \frac{k's + cd}{1 - (1-k')s^2} = \frac{1}{\sqrt{1+k'}} \frac{d + (1+k')sc}{c + sd}$$

$$= \frac{1}{\sqrt{1+k'}} \frac{\sqrt{d + (1+k')sc}}{\sqrt{d + (1-k')sc}} = \sqrt{\frac{\operatorname{dn} 2u + k' \operatorname{sn} 2u}{k' + \operatorname{dn} 2u}}.$$

[CAYLEY.]

$$13. \operatorname{cn} \left(u + \frac{K'}{2} \right) = \sqrt{\frac{k'}{1+k'}} \frac{c - sd}{1 - (1-k')s^2}$$

$$= \sqrt{\frac{k'}{1+k'}} \frac{c^2 - k's^2}{c + sd} = \sqrt{k'} \sqrt{\frac{1 - \operatorname{sn} 2u}{k' + \operatorname{dn} 2u}}.$$

$$14. \operatorname{dn} \left(u + \frac{K'}{2} \right) = \sqrt{k'} \frac{d - (1-k')sc}{1 - (1-k')s^2} = \sqrt{k'} \frac{cd + k's}{c + sd}$$

$$= \sqrt{k'} \sqrt{\frac{1 + k' \operatorname{dn} 2u - k^2 \operatorname{sn} 2u}{k' + \operatorname{dn} 2u}}.$$

$$15. \operatorname{sn} \left(u + \frac{iK'}{2} \right) = \frac{1}{\sqrt{k}} \frac{(1+k)s + id}{1 + ks^2} = \frac{1}{\sqrt{k}} \sqrt{\frac{(1+k)s + id}{(1+k)s - id}}$$

$$= \frac{1}{\sqrt{k}} \sqrt{\frac{k \operatorname{sn} 2u + i \operatorname{dn} 2u}{\operatorname{sn} 2u - i \operatorname{cn} 2u}}.$$

[CAYLEY.]

$$16. \operatorname{cn} \left(u + \frac{iK'}{2} \right) = \sqrt{\frac{1+k}{k}} \frac{c - isd}{1 + ks^2} = \sqrt{\frac{1+k}{k}} \frac{1 - ks^2}{c + isd}$$

$$= \sqrt{\frac{1+k}{k}} \sqrt{\frac{1 - ks^2}{1 + ks^2}} \frac{c - isd}{c + isd} = \frac{1}{\sqrt{k}} \sqrt{\frac{\operatorname{dn} 2u + k \operatorname{cn} 2u}{\operatorname{cn} 2u + i \operatorname{sn} 2u}}.$$

$$17. \operatorname{dn}\left(u + \frac{\iota K'}{2}\right) = \sqrt{1+k} \frac{d - \iota k s c}{1 + k s^2} = \sqrt{1+k} \frac{1 - k s^2}{d + \iota k s c}$$

$$= \sqrt{\frac{k'^2 \operatorname{sn} 2u - \iota \operatorname{cn} 2u - k' \operatorname{dn} 2u}{\operatorname{sn} 2u - \iota \operatorname{cn} 2u}}$$

$$18. \operatorname{sn}\left(u + \frac{K + \iota K'}{2}\right) = \sqrt{\frac{k + \iota k'}{k}} \frac{-\iota k' s + c d}{1 - k(k + \iota k') s^2}$$

$$= \sqrt{\frac{k + \iota k'}{k}} \frac{c + (k - \iota k') s d}{d + k s c} = \sqrt{\frac{k + \iota k'}{k}} \sqrt{c + (k - \iota k') s d}$$

$$= \frac{1}{\sqrt{k}} \sqrt{\frac{k' \operatorname{cn} 2u + \iota k'}{\operatorname{cn} 2u + \iota k' \operatorname{sn} 2u}} \quad [\text{CAYLEY.}]$$

19. Show that

$$(i) \quad s^2 \frac{d}{du} \log s = -c^2 \frac{d}{du} \log c = -\frac{d^2}{k^2} \frac{d}{du} \log d = s c d,$$

$$(ii) \quad c^2 \frac{d}{du} t d = c^2 d^2 - c^2 + d^2,$$

$$(iii) \quad s^2 \frac{d}{du} \frac{c d}{s} = -c^2 - s^2 d^2,$$

$$(iv) \quad \operatorname{dn}^2(u + \iota K') = d^2 + \frac{d}{du} \left(\frac{c d}{s}\right).$$

20. Show that $\operatorname{sn}^2(u_1 + u_2) - \operatorname{sn}^2(u_1 - u_2) - 2 \frac{\partial}{\partial u_1} \frac{s_1^2 s_2 c_2 d_2}{1 - k^2 s_1^2 s_2^2}$.

21. Show that

$$(i) \quad \int_0^u \sqrt{1 - \frac{\operatorname{cn} 2u}{1 + \operatorname{cn} 2u}} du = -\log \operatorname{cn} u,$$

$$(ii) \quad \int_0^u \sqrt{1 - \frac{\operatorname{dn} 2u}{1 + \operatorname{dn} 2u}} du = -\frac{1}{k} \log \operatorname{dn} u,$$

$$(iii) \quad \int_0^u \operatorname{sn} u \sqrt{1 + \frac{\operatorname{cn} 2u}{1 + \operatorname{dn} 2u}} du = -\frac{1}{k^2} \log \operatorname{dn} u,$$

$$(iv) \quad \int_0^u \sqrt{1 - \frac{\operatorname{sn} 2u}{1 + \operatorname{sn} 2u}} du = \frac{1}{k'} \log \left[\sqrt{1 + k'} \operatorname{sn} \left(u + \frac{K'}{2}\right) \right].$$

22. Find the values of

$$(i) \int \operatorname{cn} u \, du, \quad (ii) \int \frac{\operatorname{sn} u}{\operatorname{cn} u} \, du, \quad (iii) \int \frac{\operatorname{sn}^2 u \operatorname{dn} u}{\operatorname{cn}^2 u} \, du.$$

23. If $I_n = \int (\operatorname{sn} u)^n du$, show that

$$(n+1)k^2 I_{n+2} - n(1+k^2)I_n + (n-1)I_{n-2} = s^{n-1} c d.$$

24. If $I_n = \int (\operatorname{cn} u)^n du$, show that

$$(n+1)k^2 I_{n+2} - n(k-k'^2)I_n - (n-1)k'^2 I_{n-2} = c^{n-1} s d.$$

25. If $I_n = \int (\operatorname{dn} u)^n du$, show that

$$(n + 1)I_{n+2} - n(1 + k^2)I_n + (n - 1)k^2I_{n-2} = k^2d^{n-1}sc.$$

26. If $I_n = \int \left(\frac{\operatorname{sn} u}{\operatorname{dn} u}\right)^n du$, show that

$$(u + 1)k^2I_{n+2} - n(1 + k^2)I_n + (n - 1)I_{n-2} = -k^2\frac{sc^{n-1}}{d^{n+1}},$$

and obtain reduction formulae for $\int \left(\frac{cn u}{\operatorname{dn} u}\right)^n du$ and $\int \frac{du}{(\operatorname{dn} u)^n}$ similarly.

27. Prove that

$$(i) \frac{1 + \operatorname{dn}(u + v)}{\operatorname{sn}(u + v)} - k^2 \frac{\operatorname{sn} u \operatorname{cn} v - \operatorname{sn} v \operatorname{cn} u}{\operatorname{dn} v - \operatorname{dn} u}, \quad [M. \text{TRIP. II., 1915}]$$

$$(ii) \frac{\operatorname{dn}(u - v) - \operatorname{cn}(u - v)}{\operatorname{sn}(u - v)} = \frac{\operatorname{dn} u \operatorname{cn} v - \operatorname{cn} u \operatorname{dn} v}{\operatorname{sn} u + \operatorname{sn} v}. \quad [SIR J. J. THOMSON.]$$

28. Show that $\operatorname{sn}(u_1 + u_2)$

$$= \frac{s_1c_1d_2 + s_2c_1d_1}{1 - k^2s_1^2s_2^2} - \frac{s_1c_1d_2 + s_2c_2d_1}{c_1c_2 + s_1s_2d_1d_2} - \frac{s_1c_2d_1 + s_2c_1d_2}{d_1d_2 + k^2s_1s_2c_1c_2} = \frac{s_1^2 - s_2^2}{s_1c_2d_2 - s_2c_1d_1}. \quad [M. \text{TRIP. II., 1889.}]$$

29. If u_1, u_2, u_3, u_4 be any arguments, and x, y, z respectively denote

$$\frac{\operatorname{sn}(u_4 - u_1)\operatorname{sn}(u_2 - u_3)}{\operatorname{sn}(u_4 + u_1)\operatorname{sn}(u_2 + u_3)}, \quad \frac{\operatorname{sn}(u_4 - u_2)\operatorname{sn}(u_3 - u_1)}{\operatorname{sn}(u_4 + u_2)\operatorname{sn}(u_3 + u_1)}, \quad \frac{\operatorname{sn}(u_4 - u_3)\operatorname{sn}(u_1 - u_2)}{\operatorname{sn}(u_4 + u_3)\operatorname{sn}(u_1 + u_2)},$$

prove that $x + y + z + xyz = 0$. [M. TRIP. III., 1885.]

30. If $x_{\lambda\mu}$ denote the function

$$\operatorname{sn}(u_\lambda - u_\mu)\operatorname{cn}(u_\lambda + u_\mu) / \operatorname{cn}(u_\lambda - u_\mu)\operatorname{sn}(u_\lambda + u_\mu),$$

then $x_{41}x_{42}x_{43}x_{12}x_{23}x_{31} + x_{41}x_{23} + x_{42}x_{31} + x_{43}x_{12} = 0$. [M. TRIP. II., 1889.]

31. Find the values of $\int \operatorname{dn} u du$, $\int \frac{du}{\operatorname{dn} u}$, $\int \frac{cn u}{\operatorname{sn} u} du$.

[M. TRIP. II., 1888.]

32. Prove the formulae

$$(i) 3 \int \operatorname{dn}^4 u du = 2(1 + k'^2)\operatorname{ezn} u + k^2 \operatorname{sn} u \operatorname{cn} u \operatorname{dn} u - k'^2 u,$$

$$(ii) k^2 \int \frac{\operatorname{sn} u du}{1 + \operatorname{sn} u} = \operatorname{ezn}(u + K + iK') + \frac{\operatorname{dn} u}{\operatorname{cn} u},$$

$$(iii) k \int_0^K \operatorname{sn} u du = \frac{1}{2} \log \frac{1 + k}{1 - k},$$

where $\operatorname{ezn} u = \frac{E_1 u}{K} + \operatorname{zn} u$, and $\operatorname{zn} u$ is Jacobi's Zeta function $Z(u)$.

[M. TRIP. II., 1888.]

33. Show that $\operatorname{sn}(x + K) = \frac{c}{d}$, $\operatorname{sn}(x + 2K) = -s$, $\operatorname{sn}(ux) = t \operatorname{tn}(x, k')$.

[M. TRIP., 1876.]

Prove that, if $D = 1 - k^2 s_1^2 s_2^2$,

34. (i) $\operatorname{cn}(u_1 + u_2) \operatorname{cn}(u_1 - u_2) = (c_1^2 - s_2^2 d_1^2)/D = (c_2^2 - s_1^2 d_2^2)/D$;

(ii) $\operatorname{dn}(u_1 + u_2) \operatorname{dn}(u_1 - u_2) = (d_1^2 - k^2 s_2^2 c_1^2)/D = (d_2^2 - k^2 s_1^2 c_2^2)/D$.

35. (i) $\operatorname{cn}(u_1 + u_2) \operatorname{cn}(u_1 - u_2) + \operatorname{sn}(u_1 + u_2) \operatorname{sn}(u_1 - u_2)$
 $= (c_2^2 - s_2^2 d_1^2)/D$;

(ii) $\operatorname{cn}(u_1 + u_2) \operatorname{cn}(u_1 - u_2) - \operatorname{sn}(u_1 + u_2) \operatorname{sn}(u_1 - u_2)$
 $= (c_1^2 - s_1^2 d_2^2)/D$;

(iii) $\operatorname{dn}(u_1 + u_2) \operatorname{dn}(u_1 - u_2) + k^2 \operatorname{sn}(u_1 + u_2) \operatorname{sn}(u_1 - u_2)$
 $= (d_2^2 - k^2 s_2^2 c_1^2)/D$;

(iv) $\operatorname{dn}(u_1 + u_2) \operatorname{dn}(u_1 - u_2) - k^2 \operatorname{sn}(u_1 + u_2) \operatorname{sn}(u_1 - u_2)$
 $= (d_1^2 - k^2 s_1^2 c_2^2)/D$.

36. (i) $\frac{1 - \operatorname{sn}(u - \alpha)}{1 + \operatorname{sn}(u - \alpha)} \cdot \frac{1 - \operatorname{sn}(u + \alpha)}{1 + \operatorname{sn}(u + \alpha)} = \left\{ \frac{\operatorname{sn}(K - \alpha) - \operatorname{sn} u}{\operatorname{sn}(K - \alpha) + \operatorname{sn} u} \right\}^2$;

(ii) $\frac{1 + k \operatorname{sn}(u - \alpha)}{1 - k \operatorname{sn}(u - \alpha)} \cdot \frac{1 - k \operatorname{sn}(u + \alpha)}{1 + k \operatorname{sn}(u + \alpha)} = \left\{ \frac{1 - k \operatorname{sn} \alpha \operatorname{sn}(u + K)}{1 + k \operatorname{sn} \alpha \operatorname{sn}(u + K)} \right\}^2$.

37. (i) $\operatorname{tn}(u + \alpha) + \operatorname{tn}(u - \alpha) = \frac{2 \operatorname{sn} u \operatorname{cn} u \operatorname{dn} \alpha}{\operatorname{cn}^2 \alpha - \operatorname{dn}^2 \alpha \operatorname{sn}^2 u}$;

(ii) $\operatorname{tn}(u + \alpha) - \operatorname{tn}(u - \alpha) = \frac{2 \operatorname{sn} \alpha \operatorname{cn} \alpha \operatorname{dn} u}{\operatorname{cn}^2 \alpha - \operatorname{dn}^2 \alpha \operatorname{sn}^2 u}$.

38. Verify the identity $k^2 k'^2 S^2 - k^2 C + D - k'^2 = 0$, where S denotes the product of the four sn functions with arguments $u \pm r$, $u \pm w$, C denotes the product of the four cn functions and D the product of the four dn functions with the same arguments. [M. TRIP. II., 1914.]

39. Prove that the length of the curve of intersection of two right circular cylinders, whose axes are at right angles and radii a , b ($a < b$), is $8a \int_0^{\frac{\pi}{2}} \left(\frac{1 - k^2 \sin^4 \phi}{1 - k^2 \sin^2 \phi} \right)^{\frac{1}{2}} d\phi$, where $k^2 = a^2/b^2$; and verify the result when $a = b$. [ST. JOHN'S, 1886.]

40. Prove that the relation

$$\frac{M dy}{\{(1 - y^2)(1 - \lambda^2 y^2)\}^{\frac{1}{2}}} = \frac{dx}{\{(1 - x^2)(1 - k^2 x^2)\}^{\frac{1}{2}}},$$

where M is a constant, can be satisfied by an equation of the form $yV = U$, in which U , V are integral polynomials.

41. Show that the envelope of

$$y(\text{cn } u \text{ dn } u + k \text{ sn}^2 u) - x(\text{dn } u - k \text{ cn } u) \text{ sn } u = ak \text{ sn } u$$

is $kP + Q + \frac{k'^2}{ak}x = 0$, where $P^{\frac{2}{3}} + \left(\frac{y}{ak^2}\right)^{\frac{2}{3}} = 1$, $Q^{\frac{2}{3}} + \left(\frac{ky}{a}\right)^{\frac{2}{3}} = 1$.

[This is St. Laurent's result for the caustic by refraction for parallel rays falling upon a circle. See Heath's *Optics*, Art. 108.]

42. Show that the envelope of the straight line

$$k'^2 x \text{ sn } u + (\text{cn } u + k \text{ dn } u) y = k \text{ sn } u (\text{dn } u + k \text{ cn } u)$$

is $\frac{k'^2}{k}x = k^2 \left[1 - \left(\frac{y}{k^2}\right)^{\frac{2}{3}} \right]^{\frac{3}{2}} + k \left[1 - (ky)^{\frac{2}{3}} \right]^{\frac{3}{2}}$.

[CAYLEY on Caustics, *Ph. Tr.*, 1856.]

43. A particle under the action of a central attraction

$$\frac{\mu}{r^3} \left[1 - \frac{(l-r)^2}{e^2 l^2} \right]$$

moves from an apse at distance $l/(1+e)$ with velocity $\sqrt{\mu}(1+e)/e$; show that the orbit described is $l/r = 1 + e \text{ cn } \theta$, mod. $1/\sqrt{2}$.

[TAIT AND STEELE, *Dyn. of a Particle*, p. 393.]

44. Show that Euler's Equations of motion of a body about a fixed

point under the action of no forces, viz. $A \frac{d\omega_1}{dt} - (B-C)\omega_2\omega_3 = 0$, $B \frac{d\omega_2}{dt} - (C-A)\omega_3\omega_1 = 0$, $C \frac{d\omega_3}{dt} - (A-B)\omega_1\omega_2 = 0$, are satisfied by $\omega_1 = a \text{ sn } \lambda(t-\tau)$, $\omega_2 = b \text{ cn } \lambda(t-\tau)$, $\omega_3 = c \text{ dn } \lambda(t-\tau)$, provided the six constants $a, b, c, \lambda, \tau, k$ be suitably chosen

[KIRCHOFF. See ROUTH, *Rig. Dyn.*]

[For the treatment of these equations by aid of the Weierstrassian functions, the reader is referred to Greenhill, *Ell. F.*, Arts. 104-114.]

45. Prove that

$$-ik^{\frac{1}{2}} \text{sn}(u + \frac{1}{2}iK') = \frac{cd - i(1+k)s}{1+ks^2} = \frac{1+ks^2}{cd + i(1+k)s} = \frac{d - iksc}{c + iud} = \frac{c - iud}{d + iksc}.$$

[M. TRIP., 1888.]

46. Prove that

$$-k \text{ sn}^2(u + \frac{1}{2}iK') = \frac{D - ikS}{C + iS} = \frac{C - iS}{D + ikS} = \frac{C - kD - ik^2S}{D - kC} = \frac{D - kC}{C - kD + ik^2S},$$

where S, C, D denote $\text{sn } 2u, \text{cn } 2u, \text{dn } 2u$ respectively.

[M. TRIP., 1888.]

47. Prove that $\int_{\mathbf{K}} \sqrt{\frac{\text{dn } 2u + \text{cn } 2u}{\text{dn } 2u - \text{cn } 2u}} du = \frac{1}{k} \log \text{sn } u.$

48. Show how $\text{sn } mu$ may be expressed in terms of $\text{sn } u$, where m is an integer; and if m be odd, prove that the numerator of $1 - \text{sn } mu$ when so expressed consists of a perfect square multiplied by the factor $1 - (-1)^{\frac{1}{2}(m-1)} \text{sn } u$. [CAYLEY, *E.F.*, p. 90.]

49. If $k^2 = -\omega$, where ω is an imaginary cube root of unity, prove that

$$\frac{1 - \text{sn}(\omega - \omega^2)u}{1 + \text{sn}(\omega - \omega^2)u} = \frac{1 - \text{sn } u}{1 + \text{sn } u} \frac{(1 - \omega \text{sn } u)^2}{(1 + \omega \text{sn } u)}.$$

50. Prove that

$$\left\{ \frac{1 - k^2 \frac{\text{cn}^2(u+r) \text{cn}^2(u-v)}{\text{dn}^2(u+r) \text{dn}^2(u-v)}}{1 - k^2 \text{sn}^2(u+r) \text{sn}^2(u-v)} \right\}^{\frac{1}{2}} = k' \frac{1 - k^2 \text{sn}^2 u \text{sn}^2 v}{1 - k^2 \text{sn}^2 u - k^2 \text{sn}^2 v + k^2 \text{sn}^2 u \text{sn}^2 v}.$$

[MATH. TRIP., 1878.]

51. Prove that

$$\frac{\text{sn } u}{u} = \frac{\text{cn } \frac{1}{2}u \text{ dn } \frac{1}{2}u \cdot \text{cn } \frac{1}{4}u \text{ dn } \frac{1}{4}u \cdot \text{cn } \frac{1}{8}u \text{ dn } \frac{1}{8}u \dots}{(1 - k^2 \text{sn}^4 \frac{1}{2}u)(1 - k^2 \text{sn}^4 \frac{1}{4}u)(1 - k^2 \text{sn}^4 \frac{1}{8}u) \dots}.$$

[MATH. TRIP., 1878.]

52. Prove that

$$\frac{1 - \text{sn } u}{1 + \text{sn } u} = \frac{1}{k^2} \frac{\text{cn}^2 \frac{1}{2}(u+K) \text{ dn}^2 \frac{1}{2}(u+K)}{\text{sn}^2 \frac{1}{2}(u+K)}.$$

[MATH. TRIP., 1878.]

53. Show that if $V = \text{sn}(u+a_1) \text{sn}(u+a_2) \text{sn}(2u+a_1+a_2)$, then

$$\int U du = -\frac{1}{2k^2} \log [1 - k^2 \text{sn}^2(u+a_1) \text{sn}^2(u+a_2)].$$

54. Show that

$$\frac{\Theta^2(x+a) \Theta^2(y+a) \Theta(x+y-2a)}{\Theta^2(x-a) \Theta^2(y-a) \Theta(x+y+2a)} = \frac{1 - k^2 \text{sn}^2(x-a) \text{sn}^2(y-a)}{1 - k^2 \text{sn}^2(x+a) \text{sn}^2(y+a)}.$$

[GLAISHER.]

55. Show that

$$\int_0^u \frac{\text{cn } u - \text{sn } u \text{ dn } u}{\text{cn } u + \text{sn } u \text{ dn } u} du = \frac{1}{k'} \log \left\{ \sqrt{1 + k' \text{sn} \left(u + \frac{K}{2} \right)} \right\}.$$

56. Prove that in a spherical triangle ABC , obtuse angled at C , we may replace $\cos a$, $\cos b$, $\cos c$, $\cos A$, $\cos B$, $\cos C$ respectively by $\text{cn } u$, $\text{cn } v$, $\text{cn}(u+v)$, $\text{dn } u$, $\text{dn } v$, $-\text{dn}(u+v)$, and then

$$\cos^2 p = 1 - k^2 \text{sn}^2 u \text{sn}^2 v,$$

where p is the perpendicular arc from C on AB , and point out any other analogies between elliptic functions and spherical trigonometry. [MATH. TRIP. III., 1884.]

57. Prove that

$$(i) \Theta(2u) = \frac{\Theta^4(u)}{\Theta^2(0)} (1 - k^2 \operatorname{sn}^4 u);$$

$$(ii) \Theta(3u) = \frac{\Theta^2(2u)\Theta(u)}{\Theta^2(0)} (1 - k^2 \operatorname{sn}^2 u \operatorname{sn}^2 2u).$$

58. Prove that $Z(u) = \frac{\operatorname{sn} u \operatorname{dn} u}{\operatorname{cn} u} - \frac{\pi u}{2KK'}$, $+ Z(u, k')$.

59. Solve completely the differential equations

$$(i) \frac{d^2 u}{dt^2} + n^2 u + au^2 = 0; \quad (ii) \frac{d^2 u}{dt^2} + n^2 u + \beta u^3 = 0.$$

[MATH. TRIP., 1878.]

Show that in case (i) u is of the form

$$u = a - b \frac{1 - \operatorname{cn} \frac{K}{T}(t - \tau)}{1 + \operatorname{cn} \frac{K}{T}(t - \tau)}, \quad \text{with } \begin{cases} b^2 = (a - m)^2 + n^2, \\ k^2 = \frac{1}{2} \left(1 + \frac{a - m}{b} \right), \\ K^2 = \frac{2}{3} ab, \\ T^2 = \frac{2}{3} ab, \end{cases}$$

$$\left. \begin{array}{l} \text{or } u = -a - (a - b) \operatorname{tn}^2 \frac{K}{T}(t - \tau), \\ \text{or } u = c \operatorname{cn}^2 \frac{K}{T}(t - \tau) - b \operatorname{sn}^2 \frac{K}{T}(t - \tau), \end{array} \right\} \text{with } \begin{cases} (a + c)k^2 = b + c, \\ \frac{K^2}{T^2} = \frac{1}{6} a(a + c), \end{cases}$$

and in case (ii)

$$u = a \operatorname{cn} \frac{K}{T}(t - \tau), \quad \text{with } (a^2 + b^2)k^2 = a^2, \quad \frac{K^2}{T^2} = \frac{1}{2} \beta (a^2 + b^2).$$

[SOL. S.H. PROBLEMS, 1878.]

60. Prove that if a uniform chain fixed at two points rotate in relative equilibrium with constant angular velocity about an axis in the same plane with the line joining the two points and free from the action of gravity, the form of the curve assumed by the chain will be given by $y = b \operatorname{sn} K \frac{x}{a}$, the axis of rotation being the axis of x .

[GREENHILL, M. TRIP., 1878.]

61. Differentiations being denoted by accents, show that

$$\frac{\operatorname{cn}'' u}{\operatorname{cn} u} - \frac{\operatorname{sn}'' u}{\operatorname{sn} u} = k^2, \quad \frac{\operatorname{dn}'' u}{\operatorname{dn} u} - \frac{\operatorname{cn}'' u}{\operatorname{cn} u} = k^2, \quad \frac{\operatorname{sn}'' u}{\operatorname{sn} u} - \frac{\operatorname{dn}'' u}{\operatorname{dn} u} = -1.$$

62. If $\frac{dx}{\sqrt{1-x^4}} + \frac{dy}{\sqrt{1-y^4}} = 0$, obtain the relation between x and y in an integral form.

[MATH. TRIP., 1876.]

63. Transform the differential $dx/\sqrt{(1-x^2)(1-k^2x^2)}$ into a like expression having, instead of k , the modulus $2\sqrt{k}/(1+k)$.

64. Accents denoting differentiations, prove that

$$(i) \begin{vmatrix} \text{sn } u, & \text{sn}' u, & \text{sn}'' u \\ \text{cn } u, & \text{cn}' u, & \text{cn}'' u \\ \text{dn } u, & \text{dn}' u, & \text{dn}'' u \end{vmatrix} = -k'^2; \quad (ii) \begin{vmatrix} \text{sn } u, & \text{sn}' u, & \text{sn}''' u \\ \text{cn } u, & \text{cn}' u, & \text{cn}''' u \\ \text{dn } u, & \text{dn}' u, & \text{dn}''' u \end{vmatrix} = 0$$

65. Show that

$$(i) \begin{vmatrix} s^2, & ss', & s'^2 \\ c^2, & cc', & c'^2 \\ d^2, & dd', & d'^2 \end{vmatrix} = k'^2 scd; \quad [\text{MATHEWS. See GREENHILL, E. F., p. 349.}]$$

$$(ii) \begin{vmatrix} \text{cn } u, & \text{cn } u, & \text{cn } u, & \text{cn } u \\ \text{cn } u, & \text{dn } u, & \text{cn } u, & \text{cn } u \\ \text{cn } u, & \text{cn } u, & \text{dn } u, & \text{cn } u \\ \text{cn } u, & \text{cn } u, & \text{cn } u, & \text{dn } u \end{vmatrix} = \frac{8k'^6 \text{cn } u \text{sn}^6 \frac{u}{2}}{(1 - k^2 \text{sn}^4 \frac{u}{2})^3}.$$

66. Show that for four arguments u_1, u_2, v_1, v_2 , if differentiations of the elliptic functions with regard to their respective arguments be denoted by accents,

$$\begin{vmatrix} \text{dn } 2u_1, & \text{dn } 2u_2, & \text{cn } 2u_2, & \text{cn } 2u_1 \\ \text{cn } 2u_1, & \text{cn } 2u_2, & \text{dn } 2u_2, & \text{dn } 2u_1 \\ \text{dn } 2v_1, & \text{dn } 2v_2, & \text{cn } 2v_2, & \text{cn } 2v_1 \\ \text{cn } 2v_1, & \text{cn } 2v_2, & \text{dn } 2v_2, & \text{dn } 2v_1 \end{vmatrix} \\ = \frac{16k'^4}{U_1^2 U_2^2 V_1^2 V_2^2} [U_1 V_2 \text{sn}'^2 u_1 \text{sn}'^2 v_2 - U_2 V_1 \text{sn}'^2 u_2 \text{sn}'^2 v_1] \\ \times [U_1 V_2 \text{sn}^2 u_1 \text{sn}^2 v_2 - U_2 V_1 \text{sn}^2 u_1 \text{sn}^2 v_2],$$

where $\frac{U_1}{1 - k^2 \text{sn}^4 u_1} = \frac{U_2}{1 - k^2 \text{sn}^4 u_2} = \frac{V_1}{1 - k^2 \text{sn}^4 v_1} = \frac{V_2}{1 - k^2 \text{sn}^4 v_2} = 1$.

67. Show that

$$\begin{vmatrix} 1, & \text{cn } u, & \text{dn } u \\ 1, & \text{cn } v, & \text{dn } v \\ 1, & \text{cn } w, & \text{dn } w \end{vmatrix} = -4k^2 k'^2 \Pi \text{sn} \frac{v+w}{2} \text{sn} \frac{v-w}{2} \frac{1 - k^2 \text{sn}^2 \frac{v}{2} \text{sn}^2 \frac{w}{2}}{1 - k^2 \text{sn}^4 \frac{u}{2}}. \quad [\text{Ox. II. P., 1914.}]$$

68. Prove that

$$\begin{vmatrix} \text{sn}^2(u+v), & \text{sn}(u+v) \text{sn}(u-v), & \text{sn}^2(u-v) \\ \text{cn}^2(u+v), & \text{cn}(u+v) \text{cn}(u-v), & \text{cn}^2(u-v) \\ \text{dn}^2(u+v), & \text{dn}(u+v) \text{dn}(u-v), & \text{dn}^2(u-v) \end{vmatrix} = \frac{8k'^2 s_1 s_2^3 c_1 c_2 d_1 d_2}{(1 - k^2 s_1^2 s_2^2)^3}.$$

[MATH. TRIP. II., 1913.]

69. If $m^2 + n^2 = 1$, prove that

$$\int_0^{\frac{\pi}{2}} \int_0^{\frac{\pi}{2}} \frac{\cos^2 \theta \sin^2 \phi \, d\theta \, d\phi}{(1 - m^2 \sin^2 \theta)^{\frac{3}{2}} (1 - n^2 \sin^2 \phi)^{\frac{3}{2}}} - \int_0^{\frac{\pi}{2}} \int_0^{\frac{\pi}{2}} \frac{\sin^2 \theta \cos^2 \phi \, d\theta \, d\phi}{(1 - m^2 \sin^2 \theta)^{\frac{3}{2}} (1 - n^2 \sin^2 \phi)^{\frac{3}{2}}}.$$

70. If $u = \int_0^{\frac{\pi}{2}} \int_0^{\frac{\pi}{2}} \frac{m^2 \cos^2 \theta + n^2 \cos^2 \phi}{\sqrt{1 - m^2 \sin^2 \theta} \sqrt{1 - n^2 \sin^2 \phi}} \, d\theta \, d\phi$, then $\frac{du}{dm} = 0$.

[γ , 1891.]

71. P and Q are points one on each of two circles in parallel planes with a common axis through the centres C, C' at right angles to the planes; $CC' = b$ and the radii are A and a , $PQ = r$ and the angle between the planes $C'CP$ and $CC'Q$ is ϵ . Evaluate the integral

$M = \iint \frac{\cos \epsilon}{r} \, ds \, ds'$, the integrations extending round each circle, and throw the result into the form

$$M = 4\pi \sqrt{Aa} \left[\left(c - \frac{1}{2c} \right) F_1 - cE_1 \right],$$

where F_1 and E_1 are complete Elliptic Integrals.

CHAPTER XXXII.

ELLIPTIC INTEGRALS (*continued*). THE WEIERSTRASSIAN FORMS.

1380. It was stated in Chapter XI. that the integration of $\int \frac{dx}{\sqrt{Q}}$, where Q is a rational quartic function of x , could be made to depend by a suitable homographic substitution upon the integration $u = \int_0^z \frac{dz}{\sqrt{(1-z^2)(1-k^2z^2)}}$, where k is real and < 1 , and the properties of z when expressed as a function of u , as also those of $\sqrt{1-z^2}$ and $\sqrt{1-k^2z^2}$, have been discussed in the last chapter. This is the **Legendrian** and **Jacobian** mode of procedure.

A more modern method is due to Weierstrass. In this method the same integral, viz. $\int \frac{dx}{\sqrt{Q}}$, is shown to be also reducible by a suitable homographic transformation to the form $u = \int_z^\infty \frac{dz}{\sqrt{4z^3 - Iz - J}}$, where I, J are certain constants, viz. functions of the coefficients of Q , and of the constants of the homographic transformation formulæ. The function u , regarded as dependent upon z , is considered as the inverse function, and z expressed as a function of u as the direct function. It is usual to write $z = \wp(u)$, or $\wp(u, I, J)$ if it be desired to put into evidence the values of I and J . $\wp(u)$ is called the **Weierstrassian Function**.

The letters g_2, g_3 are very commonly used instead of I and J , but as powers of these letters occur very frequently there appears to be less risk of error in practice if we use the I, J notation.

1381. The modes of reduction of the general integral $\int \frac{dx}{\sqrt{Q}}$ to the respective Legendrian and Weierstrassian forms will be discussed at length in the next chapter. For the present we shall be occupied with an examination of the nature and properties of the function $\wp(u)$ and the allied functions $\xi(u)$ and $\sigma(u)$, respectively defined by the equations

$$\xi(u) = - \int \wp(u) du = \frac{d}{du} \log \sigma(u).$$

These are respectively referred to as the **Weierstrassian Zeta** and **Sigma** functions.

1382. **Preliminary Remarks.**

The general binary quartic

$$Q \equiv a_0 x^4 + 4a_1 x^3 y + 6a_2 x^2 y^2 + 4a_3 x y^3 + a_4 y^4$$

possesses two invariants for a linear transformation

$$x = l_1 X + m_1 Y, \quad y = l_2 X + m_2 Y,$$

viz.

$$I \equiv a_0 a_4 - 4a_1 a_3 + 3a_2^2,$$

the quadratic invariant, or quadriinvariant,

$$J \equiv a_0 a_2 a_4 + 2a_1 a_2 a_3 - a_0 a_3^2 - a_4 a_1^2 - a_2^3$$

$$\equiv \begin{vmatrix} a_0 & a_1 & a_2 \\ a_1 & a_2 & a_3 \\ a_2 & a_3 & a_4 \end{vmatrix}, \text{ the cubic invariant, or cubin-variant.}$$

If a transformation of this kind has reduced the original quartic to the form

$$0. X^4 + 4X^3 Y + 6. 0X^2 Y^2 + 4a'_3 X Y^3 + a'_4 Y^4,$$

then for this new form

$$I' = 0. a'_4 - 4. 1a'_3 + 3. 0 = -4a'_3 \text{ and } J' = \begin{vmatrix} 0 & 1 & 0 \\ 1 & 0 & a'_3 \\ 0 & a'_3 & a'_4 \end{vmatrix} = -a'_4,$$

and the form has become

$$Y(4X^3 - I'XY^2 - J'Y^3),$$

or if Y be unity, $4X^3 - IX - J$, the accents being dropped as the meanings of I and J will be obvious.

1383. If e_1, e_2, e_3 be the roots of the equation $4z^3 - Iz - J = 0$, so that $4z^3 - Iz - J \equiv 4(z - e_1)(z - e_2)(z - e_3)$, we shall lose no

generality in assuming for the present that e_1, e_2, e_3 are all real. For it will be shown that if two of these quantities be complementary imaginaries, say e_2, e_3 , then a substitution of the form $\xi - \eta_1 = (z - e_2)(z - e_3)/(z - e_1)$ will reduce the integration

$$\int_z^\infty \frac{dz}{\sqrt{4(z - e_1)(z - e_2)(z - e_3)}}$$

to the similar form

$$\int_\xi^\infty \frac{d\xi}{\sqrt{4(\xi - \eta_1)(\xi - \eta_2)(\xi - \eta_3)}},$$

where η_1, η_2, η_3 are all real constants such that $\eta_1 + \eta_2 + \eta_3 = 0$ (Art. 1456). We therefore assume for the present that e_1, e_2, e_3 are all real, $e_1 + e_2 + e_3 = 0$ and $e_1 > e_2 > e_3$. We also have

$$\begin{aligned} \frac{I}{4} &= -(e_2 e_3 + e_3 e_1 + e_1 e_2) \\ &= \frac{e_1^2 + e_2^2 + e_3^2}{2} = e_1^2 - e_2 e_3 = e_2^2 - e_3 e_1 = e_3^2 - e_1 e_2, \end{aligned}$$

$$\frac{J}{4} = e_1 e_2 e_3.$$

1384. The Differential Coefficients of $\wp(u)$.

The integral $\wp^{-1}(z) = u \equiv \int_z^\infty \frac{dz}{\sqrt{4z^3 - Iz - J}}$ is made definite at the upper limit, the integrand vanishing when z is infinite.

Differentiating, $\frac{dz}{du} = -\sqrt{4z^3 - Iz - J}$, i.e. $\wp'(u) = -\sqrt{4\wp^3(u) - I\wp(u) - J}$, i.e. $\wp'^2(u) = 4\wp^3(u) - I\wp(u) - J$. Hence also

$$\wp''(u) = 6\wp^2(u) - \frac{1}{2}I = 6z^2 - \frac{1}{2}I, \quad \wp'''(u) = 12\wp(u)\wp'(u) - 12z z',$$

$$\wp^{(4)}(u) = 12[\wp'^2(u) + \wp(u)\wp''(u)] = 12\left[10z^3 - \frac{3}{2}Iz - J\right],$$

$$\wp^{(5)}(u) = [360\wp^2(u) - 18I]\wp'(u) = (360z^2 - 18I)z', \text{ etc. ;}$$

whence it appears that the successive differential coefficients of $\wp(u)$ with regard to u are alternately irrational and rational functions of $\wp(u)$.

1385. Periodicity of $\wp(u)$.

It has already been seen that the function w defined by $w^2 = 1/4(z - e_1)(z - e_2)(z - e_3)$ is a two-branched function having branch-points at $z = e_1, z = e_2, z = e_3$, and at $z = \infty$ (Art. 1295),

and that in consequence $\int_z^\infty \frac{dz}{\sqrt{4(z-e_1)(z-e_2)(z-e_3)}}$ has three periods $2\omega_1, 2\omega_2, 2\omega_3$, where

$$\omega_1 = \int_{e_1}^\infty w dz, \quad \omega_2 = \int_{e_2}^\infty w dz, \quad \omega_3 = \int_{e_3}^\infty w dz,$$

these periods being not independent but connected by a linear relation, viz. $\omega_1 - \omega_2 + \omega_3 = 0$. Of the three we shall consider $2\omega_1$ and $2\omega_3$ to be the independent periods.

We have also shown that if u_0 be any definite value of the integral $\int_z^\infty w dz$, say that obtained by integrating along any straight-line path extending from z to ∞ , which does not pass through any of the points $z=e_1, z=e_2, z=e_3$, then all other values are comprised in the system,

$$\left. \begin{aligned} u - 2\lambda\omega_1 + 2\mu\omega_3 + u_0, \\ u - 2\lambda'\omega_1 + 2\mu'\omega_3 + 2\omega_1 - u_0, \end{aligned} \right\} \text{where } \lambda, \mu, \lambda', \mu' \text{ are integers.}$$

In consequence we have $\wp(2m\omega_1 + 2n\omega_3 \pm u) = \wp(u)$, where m, n are integers, an equation which expresses the double periodicity of the function. And this is equivalent to the statement that the most general solution of the equation

$$\wp(u) = \wp(u_0) \text{ is } u = 2m\omega_1 + 2n\omega_3 \pm u_0, \text{ } m, n \text{ being integers.}$$

Further, it follows that

$$\begin{aligned} \wp'(2m\omega_1 + 2n\omega_3 + u) &= \wp'(u), & \wp'(2m\omega_1 + 2n\omega_3 - u) &= -\wp'(u), \\ \wp''(2m\omega_1 + 2n\omega_3 \pm u) &= \wp''(u), \\ \wp'''(2m\omega_1 + 2n\omega_3 + u) &= \wp'''(u), & \wp'''(2m\omega_1 + 2n\omega_3 - u) &= -\wp'''(u), \end{aligned}$$

and so on.

And in the special cases when $m=n=0$, we get

$$\begin{aligned} \wp(-u) &= \wp(u), & \wp'(-u) &= -\wp'(u), \\ \wp''(-u) &= \wp''(u), & \wp'''(-u) &= -\wp'''(u), \text{ etc.} \end{aligned}$$

1386. These results are obvious from another consideration; viz. if we consider $(4z^3 - Iz - J)^{-\frac{1}{2}}$ as expanded in a convergent series of negative powers of z , that expansion will begin with the term $\frac{1}{2z^{\frac{3}{2}}} + \dots$. Integrating between z and ∞ , we have $u = \frac{1}{z^{\frac{1}{2}}} + \dots$; and squaring, $u^2 = \frac{1}{z} + \dots$, and therefore by reversion of series $z = \frac{1}{u^2} + \text{even powers of } u$, i.e. $\wp(u)$ is an

even function of u . [This expansion will be found carried out in Art. 1416.]

Thus $\wp'(u)$, $\wp''(u)$, $\wp'''(u)$... are alternately odd and even functions of u , whence $\wp(-u) = \wp(u)$, $\wp'(-u) = -\wp'(u)$, $\wp''(-u) = \wp''(u)$, etc., as stated.

Further, since these series for $\wp(u)$, $\wp'(u)$, $\wp''(u)$, ... all start with a negative power of u , it will be clear that $\wp(0)$, $\wp'(0)$, $\wp''(0)$, ... are all infinite, and the orders of these infinities are respectively those of $\frac{1}{u^2}$, $\frac{1}{u^3}$, $\frac{1}{u^4}$, ..., so that, for instance,

$$Lt_{u \rightarrow 0} \frac{\wp'(u)}{\wp''(u)} = Lt_{u \rightarrow 0} \frac{\left(\frac{1}{u^2}\right)^3}{\left(-\frac{2}{u^3}\right)^2} = 1.$$

1387. THE ADDITION FORMULA FOR THE FUNCTION $\wp(u)$.

Consider the solution of the Eulerian Equation $\frac{dx}{\sqrt{X}} + \frac{dy}{\sqrt{Y}} = 0$ for the case when

$$X = 4x^3 - 4x - J, \quad Y = 4y^3 - 4y - J.$$

Let $u = \int_x^\infty \frac{dx}{\sqrt{X}}$, $v = \int_y^\infty \frac{dy}{\sqrt{Y}}$, i.e. $x = \wp(u)$, $y = \wp(v)$. Then

$$\frac{dx}{du} = -\sqrt{X}, \quad \frac{dy}{dv} = -\sqrt{Y} \quad \text{and} \quad du + dv = -\left(\frac{dx}{\sqrt{X}} + \frac{dy}{\sqrt{Y}}\right) = 0.$$

Thus, one form of the integral is $u + v = C$, a constant. ... (1)

We can obtain another form of the integral as follows:

Introduce another variable t such that

$$\frac{dx}{\sqrt{X}} = -\frac{dy}{\sqrt{Y}} = -\frac{dt}{x-y},$$

and let $x + y = P$.

$$\text{Then} \quad \frac{dP}{\sqrt{X} - \sqrt{Y}} = -\frac{dt}{x-y}, \quad \text{i.e.} \quad \frac{dP}{dt} = \frac{\sqrt{X} - \sqrt{Y}}{x-y}.$$

Differentiating with regard to t ,

$$\begin{aligned} \frac{d^2P}{dt^2} &= -\frac{1}{x-y} \left[\frac{1}{2\sqrt{X}} \frac{dX}{dx} \frac{-\sqrt{X}}{x-y} - \frac{1}{2\sqrt{Y}} \frac{dY}{dy} \frac{\sqrt{Y}}{x-y} \right] \\ &\quad + \frac{\sqrt{X} - \sqrt{Y}}{(x-y)^2} \left[\frac{-\sqrt{X}}{x-y} - \frac{\sqrt{Y}}{x-y} \right] \\ &= \frac{1}{(x-y)^2} \left[2 \left(\frac{dX}{dx} + \frac{dY}{dy} \right) - \frac{X-Y}{x-y} \right]. \end{aligned}$$

Now

$$\frac{dX}{dx} + \frac{dY}{dy} = 12(x^2 + y^2) - 2I, \quad \text{and} \quad \frac{X - Y}{x - y} = 4(x^2 + xy + y^2) - I;$$

$$\therefore \frac{d^2P}{dt^2} = \frac{2(x^2 - 2xy + y^2)}{(x - y)^2} = 2, \quad \text{i.e.} \quad 2 \frac{dP}{dt} \cdot \frac{d^2P}{dt^2} = 4 \frac{dP}{dt},$$

$$\text{i.e.} \quad \left(\frac{dP}{dt}\right)^2 = 4(P + C') \quad \text{or} \quad P = \frac{1}{4} \left(\frac{dP}{dt}\right)^2 - C',$$

where C' is a constant.(2)

Now this equation having been obtained on the supposition that $\frac{dx}{\sqrt{X}} + \frac{dy}{\sqrt{Y}} = 0$, i.e. that $u + v =$ a constant C , it appears that C' is a constant, provided that C is a constant; i.e. C' is a function of C , say $\phi(C)$. We thus have the equation

$$P = \frac{1}{4} \left(\frac{dP}{dt}\right)^2 - \phi(u + v),$$

and we have to identify the form of the function ϕ .

Now

$$P = x + y = \wp(u) + \wp(v), \quad \text{and} \quad \frac{dP}{dt} = -\frac{\sqrt{X} - \sqrt{Y}}{x - y} = \frac{\wp'(u) - \wp'(v)}{\wp(u) - \wp(v)},$$

$$\begin{aligned} \text{i.e.} \quad \phi(u + v) &= \frac{1}{4} \left[\frac{\wp'(u) - \wp'(v)}{\wp(u) - \wp(v)} \right]^2 - x - y \\ &= [\wp'^2(u) - 2\wp'(u)\wp'(v) + \wp'^2(v) - 4(x + y)(x - y)^2] / 4(x - y)^2 \\ &= [\wp'^2(u) + 2\wp'(u)\sqrt{4y^2 - Iy - J} - Iy - J - 4x^3 \\ &\quad + 4x^2y + 4xy^2] / 4(x - y)^2. \end{aligned}$$

Now let v diminish indefinitely. Then $\wp(v)$ or y becomes infinitely great, and we have $\phi(u) = \lim_{y \rightarrow \infty} \frac{4xy^2}{4y^2} = x = \wp(u)$, and the form of ϕ is now identified as that of the Weierstrassian function \wp .

$$\text{Hence} \quad P = \frac{1}{4} \left(\frac{dP}{dt}\right)^2 - \wp(u + v).$$

$$\text{That is} \quad \wp(u + v) + \wp(u) + \wp(v) = \frac{1}{4} \left[\frac{\wp'(u) - \wp'(v)}{\wp(u) - \wp(v)} \right]^2,$$

which, as it expresses $\wp(u + v)$ in terms of $\wp(u)$, $\wp(v)$ and their differential coefficients, forms the addition formula for this function.

1388. **Symmetrical Form.**

Taking a third function w , such that $u+v+w=0$, then

$$\varphi(u+v) = \varphi(-w) = \varphi(w).$$

Therefore we have the symmetrical form

$$\begin{aligned} \varphi(u) + \varphi(v) + \varphi(w) &= \frac{1}{4} \left[\frac{\varphi'(u) - \varphi'(v)}{\varphi(u) - \varphi(v)} \right]^2 \\ &= \frac{1}{4} \left[\frac{\varphi'(v) - \varphi'(w)}{\varphi(v) - \varphi(w)} \right]^2 = \frac{1}{4} \left[\frac{\varphi'(w) - \varphi'(u)}{\varphi(w) - \varphi(u)} \right]^2, \end{aligned}$$

by symmetry, and therefore

$$\frac{\varphi'(u) - \varphi'(v)}{\varphi(u) - \varphi(v)} = \frac{\varphi'(v) - \varphi'(w)}{\varphi(v) - \varphi(w)} = \frac{\varphi'(w) - \varphi'(u)}{\varphi(w) - \varphi(u)},$$

whence

$$\varphi(u) [\varphi'(v) - \varphi'(w)] + \varphi(v) [\varphi'(w) - \varphi'(u)] + \varphi(w) [\varphi'(u) - \varphi'(v)] = 0,$$

and we have the symmetrical relation

$$\begin{vmatrix} 1, & \varphi(u), & \varphi'(u) \\ 1, & \varphi(v), & \varphi'(v) \\ 1, & \varphi(w), & \varphi'(w) \end{vmatrix} = 0.$$

1389. **Various Results derived.**

In the formula

$$\varphi(u+v) + \varphi(u) + \varphi(v) = \frac{1}{4} \left[\frac{\varphi'(u) - \varphi'(v)}{\varphi(u) - \varphi(v)} \right]^2$$

change the sign of v . Then, remembering that $\varphi(-v) = \varphi(v)$ and $\varphi'(-v) = -\varphi'(v)$ (Art. 1385), we have

$$\varphi(u-v) + \varphi(u) + \varphi(v) = \frac{1}{4} \left[\frac{\varphi'(u) + \varphi'(v)}{\varphi(u) - \varphi(v)} \right]^2;$$

whence

$$\left. \begin{aligned} \varphi(u+v) + \varphi(u-v) + 2\varphi(u) + 2\varphi(v) &= \frac{1}{2} \frac{\varphi'^2(u) + \varphi'^2(v)}{\{\varphi(u) - \varphi(v)\}^2}, \\ \varphi(u+v) - \varphi(u-v) &= -\frac{\varphi'(u)\varphi'(v)}{\{\varphi(u) - \varphi(v)\}^2}. \end{aligned} \right\}$$

1390. Take a function of x, y , viz. $F(x, y)$, such that

$$F(x, y) \equiv 2xy(x+y) - I \frac{x+y}{2} - J,$$

so that

$$F(x, x) = 4x^3 - Ix - J = \varphi^2(x),$$

and

$$F(y, y) = 4y^3 - Iy - J = \varphi^2(y).$$

Then

$$\begin{aligned}\wp(u+v) + \wp(u-v) &= \frac{1}{2} \frac{4x^3 - Ix - J + 4y^3 - Iy - J}{(x-y)^2} - 2(x+y) \\ &= \{2xy(x+y) - \frac{1}{2}I(x+y) - J\} / (x-y)^2 = F(x, y) / (x-y)^2;\end{aligned}$$

whence
$$\wp(u-v) + \wp(u+v) = \frac{F\{\wp(u), \wp(v)\}}{\{\wp(u) - \wp(v)\}^2};$$

also
$$\wp(u-v) - \wp(u+v) = \frac{\wp'(u)\wp'(v)}{\{\wp(u) - \wp(v)\}^2};$$

$$\therefore \wp(u+v) = \frac{1}{2} \frac{F\{\wp(u), \wp(v)\} - \wp'(u)\wp'(v)}{\{\wp(u) - \wp(v)\}^2}.$$

1391. In the formula

$$\wp(u+v) + \wp(u) + \wp(v) = \frac{1}{4} \left[\frac{\wp'(u) - \wp'(v)}{\wp(u) - \wp(v)} \right]^2,$$

let v approach to ultimate coincidence with u . Then

$$\begin{aligned}\wp(2u) + 2\wp(u) &= \frac{1}{4} \lim_{v \rightarrow u} \left[\frac{\wp'(u) - \wp'(v)}{\wp(u) - \wp(v)} \right]^2 = \frac{1}{4} \left\{ \frac{\wp''(u)}{\wp'(u)} \right\}^2 \\ &= \frac{1}{4} \left\{ \frac{d}{du} \log \wp(u) \right\}^2,\end{aligned}$$

or

$$= \frac{1}{4} \frac{\{6\wp^2(u) - \frac{1}{2}I\}^2}{4\wp^3(u) - I\wp(u) - J}.$$

1392. Hence

$$\wp(2u) = \frac{1}{4} \frac{\{6\wp^2(u) - \frac{1}{2}I\}^2}{4\wp^3(u) - I\wp(u) - J} - 2\wp(u) = \frac{\{\wp^2(u) + \frac{1}{4}I\}^2 + 2J\wp(u)}{4\wp^3(u) - I\wp(u) - J},$$

which is a rational function of $\wp(u)$.

1393. Moreover

$$\begin{aligned}\frac{d^2}{du^2} \log \wp'(u) &= \frac{d}{du} \frac{\wp''(u)}{\wp'(u)} = \frac{\wp'''(u)\wp'(u) - \wp''^2(u)}{\wp'^2(u)} \\ &= [12\wp'^2(u)\wp(u) - 4\wp'^2(u)\{\wp(2u) + 2\wp(u)\}] / \wp'^2(u) = 4\wp(u) - 4\wp(2u); \\ \therefore \wp(2u) &= \wp(u) - \frac{1}{4} \frac{d^2}{du^2} \log \wp'(u).\end{aligned}$$

1394. Another form is

$$\wp(2u) - \wp(u) = - \frac{3\wp^4(u) - \frac{3}{2}I\wp^2(u) - 3J\wp(u) - \frac{1}{8}I^2}{4\wp^3(u) - I\wp(u) - J}.$$

Since $\wp(2u) = \frac{\wp^4(u) + \frac{1}{2}I\wp^2(u) + 2J\wp(u) + \frac{1}{8}I^2}{4\wp^3(u) - I\wp(u) - J}$, we have

$$\begin{aligned}4\wp(2u) - \wp(u) &= \frac{3I\wp^2(u) + 9J\wp(u) + \frac{1}{4}I^2}{4\{\wp(u) - e_1\}\{\wp(u) - e_2\}\{\wp(u) - e_3\}} \\ &= \frac{A}{\wp(u) - e_1} + \frac{B}{\wp(u) - e_2} + \frac{C}{\wp(u) - e_3},\end{aligned}$$

where $A = (3Ie_1^2 + 9Je_1 + I^2)/4(e_1 - e_2)(e_1 - e_3)$

$$= [-3(e_2e_3 - e_1^2)e_1^2 + 9e_1^2e_2e_3 + (e_2e_3 - e_1^2)^2](e_1 - e_2)(e_1 - e_3)$$

$$= [(e_2e_3 - e_1^2)(e_2e_3 - 4e_1^2) + 9e_1^2e_2e_3]/(e_1 - e_2)(e_1 - e_3)$$

$$= (e_2e_3 + 2e_1^2)^2/(e_2e_3 + 2e_1^2) = e_2e_3 + 2e_1^2 = (e_1 - e_2)(e_1 - e_3);$$

$$\therefore 4\wp(2u) - \wp(u) = \frac{(e_1 - e_2)(e_1 - e_3)}{\wp(u) - e_1} + \frac{(e_2 - e_3)(e_2 - e_1)}{\wp(u) - e_2} + \frac{(e_3 - e_1)(e_3 - e_2)}{\wp(u) - e_3}.$$

1395. Put $v=2u$ in the formula

$$\wp(v+u) + \wp(v-u) = \frac{F\{\wp(u), \wp(v)\}}{\{\wp(u) - \wp(v)\}^2}.$$

Then $\wp(3u) + \wp(u) = \frac{F\{\wp(2u), \wp(u)\}}{\{\wp(2u) - \wp(u)\}^2}$, so that $\wp(3u)$ can be expressed rationally in terms of $\wp(u)$.

1396. Now put $v=nu$. Then

$$\wp(n+1)u + \wp(n-1)u = \frac{F\{\wp(nu), \wp(u)\}}{\{\wp(nu) - \wp(u)\}^2},$$

which expresses $\wp(n+1)u$ in terms of $\wp(nu)$, $\wp(n-1)u$ and $\wp(u)$ in rational form, whence $\wp(n+1)u$ is a rational function of $\wp(u)$. Thus it appears that $\wp(2u)$, $\wp(3u)$, $\wp(4u)$, etc., can all be expressed as rational algebraic functions of $\wp(u)$. But the expressions for these successive forms rapidly increase in complexity.

1397. Again, using the formula

$$\wp(v+u) - \wp(v-u) = - \frac{\wp'(v)\wp'(u)}{\{\wp(v) - \wp(u)\}^2},$$

and putting $v=2u, 3u$, etc.,

$$\wp(3u) - \wp(u) = - \frac{\wp'(2u)\wp'(u)}{\{\wp(2u) - \wp(u)\}^2},$$

$$\wp(4u) - \wp(2u) = - \frac{\wp'(3u)\wp'(u)}{\{\wp(3u) - \wp(u)\}^2}, \dots$$

$$\wp(n+1)u - \wp(n-1)u = - \frac{\wp'(nu)\wp'(u)}{\{\wp(nu) - \wp(u)\}^2},$$

from which $\wp(3u)$, $\wp(4u)$, ... may be successively calculated; and it is noticeable that

$$\wp'(2u)\wp'(u), \quad \wp'(3u)\wp'(u), \quad \wp'(4u)\wp'(u), \dots$$

are all rational algebraic functions of $\wp(u)$.

1398. **General Value of $\wp(nu) - \wp(u)$.** SCHWARZ.

We shall show later that the general form of $\wp(nu)$ is given by the formula

$$\wp(nu) - \wp(u) = -\frac{\psi_{n-1} \psi_{n+1}}{\psi_n^2},$$

where ψ_n is expressed in terms of Sigma Functions.

Schwarz has shown that

$$\wp(nu) - \wp(u) = -\frac{1}{n^2} \frac{d^2}{du^2} \log \psi_n,$$

where $\psi_n = \frac{(-1)^{n-1} \Delta_n}{\{1!2!3! \dots (n-1)!\}^2}$ and Δ_n stands for the determinant

$$\begin{vmatrix} \wp'(u), & \wp''(u), & \wp'''(u), & \dots & \wp^{(n-1)}(u) \\ \wp''(u), & \wp'''(u), & \wp^{(4)}(u), & \dots & \wp^{(n)}(u) \\ \dots & \dots & \dots & \dots & \dots \\ \wp^{(n-1)}(u), & \wp^{(n)}(u), & \wp^{(n+1)}(u), & \dots & \wp^{(2n-1)}(u) \end{vmatrix}.$$

The method of establishing this result is pointed out by Greenhill (*E.F.*, p. 300, etc.), but the proof lies outside the scope of the present account.

For immediate purposes we may establish a difference equation which will suffice to give us the values of the function $\wp(nu) - \wp(u)$ in terms of $\wp(u)$ for low values of n , such as $n = 3, 4, 5, 6$, etc., which is all that we shall require.

1399. **A Difference Equation.**

From the formula

$$\wp(v+u) + \wp(v-u) = \{2xy(x+y) - \frac{1}{2}I(x+y) - J\} (x-y)^2,$$

where $x = \wp(u)$, $y = \wp(v)$, we have, by putting

$$v = nu \text{ and } \wp(nu) - \wp(u) = R_n,$$

$$R_{n+1} + R_{n-1} = \frac{2x(x+R_n)(2x+R_n) - \frac{1}{2}I(2x+R_n) - J}{R_n^2} - 2x$$

$$= \frac{(4x^3 - Ix - J) + (6x^2 - \frac{1}{2}I)R_n + 2xR_n^2}{R_n^2} - 2x$$

$$= \{\wp'^2(u) + R_n \wp''(u)\} / R_n^2,$$

i.e. $R_{n+1} = \frac{\wp'^2(u)}{R_n^2} + \frac{\wp''(u)}{R_n} - R_{n-1} \dots \dots \dots (I)$

Putting $\chi_2 = \wp''(u) = 6x^2 - \frac{1}{2}I$, $\chi_3 = \wp'^2(u) = 4x^3 - Ix - J$,
 $\chi_4 = 3x^4 - \frac{3}{2}Ix^2 - 3Jx - \frac{1}{6}I^2 = 3\wp(u)\wp'^2(u) - \frac{1}{4}\wp''^2(u)$
 $= \frac{1}{4}\{\wp'(u)\wp'''(u) - \wp'^2(u)\},$

where the suffixes of χ denote the degree in x in each case, the difference equation is $R_{n+1} + R_{n-1} = \frac{\chi_3 + \chi_2 R_n}{R_n^2}$, with the starting equations $R_1 = 0$,

$$R_2 = -\frac{\chi_4}{\chi_3}, \text{ whence } R_3 = \chi_3 \frac{(\chi_3^2 - \chi_2 \chi_4)}{\chi_4^2} = -\frac{\chi_3 \chi_6}{\chi_4^2}, \text{ say, where } \chi_6 \equiv \chi_2 \chi_4 - \chi_3^2.$$

The suffix notation will suffice until the case of R_6 , when a second factor of degree 12 occurs after χ_{12} has been used. We may denote this second factor by ϕ_{12} .

1400. Other forms of the difference equation may be convenient, and may be used, now we have found R_3 , for we may eliminate χ_2 or χ_3 , or both of them.

Since

$$R_{n+1} R_n + R_n R_{n-1} = \chi_2 + \frac{\chi_3}{R_n} \quad \text{and} \quad R_{n+2} R_{n+1} + R_{n+1} R_n = \chi_2 + \frac{\chi_3}{R_{n+1}},$$

we have
$$R_{n+2} R_{n+1} - R_n R_{n-1} = -\chi_3 \left(\frac{1}{R_n} - \frac{1}{R_{n+1}} \right)$$

i.e.
$$R_{n+2} = \frac{R_{n-1}}{R_{n+1}} R_n - \frac{\chi_3}{R_{n+1}} \left(\frac{1}{R_n} - \frac{1}{R_{n+1}} \right); \dots\dots\dots(II)$$

or again,
$$(R_{n+2} + R_n) R_{n+1}^2 - (R_{n+1} + R_{n-1}) R_n^2 = \chi_2 (R_{n+1} - R_n). \dots\dots(III)$$

From either of these equations or by another application of (I), R_4 can be found; after which we may eliminate both χ_2 and χ_3 , and form an equation connecting the R 's of any five consecutive suffixes, viz.

$$\begin{vmatrix} R_{n+1}^2 (R_n + R_{n+2}), & R_{n+1}, & 1 \\ R_n^2 (R_{n-1} + R_{n+1}), & R_n, & 1 \\ R_{n-1}^2 (R_{n-2} + R_n), & R_{n-1}, & 1 \end{vmatrix} = 0;$$

whence
$$\frac{(R_{n+1} - R_n)(R_{n+1} - R_{n-1})(R_{n+1} - R_{n-2})}{R_{n+1}^2} + \frac{(R_{n-1} - R_n)(R_{n-1} - R_{n+1})(R_{n-1} - R_{n+2})}{R_{n-1}^2} = 0, \dots(IV)$$

in which a factor has been inserted for symmetry.

Now, putting $n = 2$ in (II), we may readily show that

$$R_4 = -\frac{\chi_4 \chi_{12}}{\chi_3 \chi_6^2}, \text{ where } \chi_{12} \equiv \chi_3^2 \chi_6 - \chi_4^3;$$

putting $n = 3$ in (IV), we similarly get

$$R_5 = -\frac{\chi_3 \chi_4 \chi_6 \phi_{12}}{\chi_{12}^2}, \text{ where } \phi_{12} \equiv \chi_{12} - \chi_6^2;$$

and putting $n = 4$,

$$R_6 = -\frac{\chi_{12} \phi_{24}}{\chi_3 \chi_4^2 \phi_{12}^2}, \text{ where } \phi_{24} \equiv \chi_3^2 \chi_6 \phi_{12} - \chi_{12}^2,$$

and so on.

From the several connecting equations,

$$\begin{aligned} \chi_6 &= \chi_2 \chi_4 - \chi_3^2, & \chi_{12} &= \chi_3^2 \chi_6 - \chi_4^3, & \phi_{12} &= \chi_{12} - \chi_6^2, \\ \phi_{24} &= \chi_3^2 \chi_6 \phi_{12} - \chi_{12}^2, \text{ etc.} \end{aligned}$$

we can readily express $\chi_6, \chi_{12}, \phi_{12}$, etc., in terms of the original quantities χ_2, χ_3, χ_4 , so that the successive values of $\wp(nu) - \wp(u)$ may be obtained in terms of x . Collecting the results, we have

$$\wp(2u) - \wp(u) = -\frac{\chi_4}{\chi_3}, \quad \wp(3u) - \wp(u) = -\frac{\chi_1 \chi_6}{\chi_4^2}, \quad \wp(4u) - \wp(u) = -\frac{\chi_4 \chi_{12}}{\chi_3 \chi_6^2},$$

$$\wp(5u) - \wp(u) = -\frac{\chi_1 \chi_4 \chi_6 \phi_{12}}{\chi_{12}^2}, \quad \wp(6u) - \wp(u) = -\frac{\chi_{12} \phi_{24}}{\chi_3 \chi_4^2 \phi_{12}^2}, \text{ etc.,}$$

and the notation shows the nature of the factorisation of the several numerators and denominators.

If we change the notation, and write

$\chi_3 \equiv \psi_2^2, \quad \chi_4 = \psi_3, \quad \chi_6 = \psi_4/\psi_2, \quad \chi_{12} = \psi_6, \quad \phi_{12} = \psi_6/\psi_2 \psi_3, \quad \phi_{24} = \psi_7,$
etc., with $\psi_1 = 1$, we get

$$\wp(2u) - \wp(u) = -\frac{\psi_1 \psi_3}{\psi_2^2}, \quad \wp(3u) - \wp(u) = -\frac{\psi_2 \psi_4}{\psi_3^2},$$

$$\wp(4u) - \wp(u) = -\frac{\psi_1 \psi_5}{\psi_4^2}, \quad \wp(5u) - \wp(u) = -\frac{\psi_4 \psi_6}{\psi_5^2},$$

$$\wp(6u) - \wp(u) = -\frac{\psi_5 \psi_7}{\psi_6^2}, \text{ etc.}$$

1401. Factorisation of ψ_3 , etc.

If we consider the solution of $\wp(2u) = \wp(u)$, we may infer the factorisation of χ_4 , *i.e.* ψ_3 .

The equation gives $2u = 2m\omega_1 + 2n\omega_3 \pm u$. Therefore

$$u = \frac{2m}{3}\omega_1 + \frac{2n}{3}\omega_3 \quad \text{or} \quad 2m\omega_1 + 2n\omega_3.$$

The principal solutions are

$$\frac{2\omega_1}{3}, \quad \frac{2\omega_3}{3}, \quad \frac{2\omega_1 + 2\omega_3}{3}, \quad \frac{2\omega_1 - 2\omega_3}{3},$$

and any other solutions, such for instance as

$$\frac{4\omega_1 + 2\omega_3}{3}, \quad \frac{4\omega_1 \pm 6\omega_3}{3}, \text{ etc.,}$$

are merely such that when added to one or other of the four principal solutions we obtain a complete period. Hence the factors of χ_4 are

$$\begin{aligned} \chi_4 \equiv \psi_3 \equiv & 3 \left[\wp(u) - \wp\left(\frac{2\omega_1}{3}\right) \right] \left[\wp(u) - \wp\left(\frac{2\omega_3}{3}\right) \right] \\ & \times \left[\wp(u) - \wp\left(\frac{2\omega_1 + 2\omega_3}{3}\right) \right] \left[\wp(u) - \wp\left(\frac{2\omega_1 - 2\omega_3}{3}\right) \right], \end{aligned}$$

and since $\chi_4 \equiv 3\wp^4(u) - \frac{3}{2}I\wp^2(u) - 3J\wp(u) - \frac{1}{6}I^2$, we have various

results from the consideration of various symmetrical functions of the roots of the quartic $\chi_4=0$; for instance

$$\wp\left(\frac{2\omega_1}{3}\right) + \wp\left(\frac{2\omega_2}{3}\right) + \wp\left(\frac{2\omega_1+2\omega_2}{3}\right) + \wp\left(\frac{2\omega_1-2\omega_2}{3}\right) = 0,$$

$$\wp\left(\frac{2\omega_1}{3}\right) \cdot \wp\left(\frac{2\omega_2}{3}\right) \cdot \wp\left(\frac{2\omega_1+2\omega_2}{3}\right) \cdot \wp\left(\frac{2\omega_1-2\omega_2}{3}\right) = -\frac{1}{4}I^2, \text{ etc.},$$

and similar results will follow from a consideration of the equations $\wp(3u)=\wp(u)$, $\wp(4u)=\wp(u)$, etc.

1402. Let $Q_x = 4(x - e_1)(x - e_2)(x - e_3)$, $v = \wp(u)$, $y = \wp(v)$, $z = \wp(w)$. Then

$$\begin{aligned} & [\sqrt{y-e_1}\sqrt{z-e_2}(\bar{z}-e_3) - \sqrt{z-e_1}\sqrt{y-e_2}(y-e_3)]^2 \\ & = (y-e_1)(z^2+e_1z+e_2e_3) + (-e_1)(y^2+e_1y+e_2e_3) - \frac{1}{2}\sqrt{Q_y}\sqrt{Q_z} \\ & = yz(y+z) - \frac{1}{2}I(y+z) - \frac{1}{2}J - e_1(y-z)^2 - \frac{1}{2}\sqrt{Q_y}\sqrt{Q_z} \\ & = \frac{1}{2}[F(y, z) - \sqrt{Q_y}\sqrt{Q_z}] - e_1(y-z)^2 = (y-z)^2 \left\{ \frac{1}{2} \frac{F(y, z) - \sqrt{Q_y}\sqrt{Q_z}}{(y-z)^2} - e_1 \right\} \\ & = \{\wp(v) - \wp(w)\}^2 \{\wp(v+w) - e_1\}. \text{ That is} \end{aligned}$$

$\sqrt{\wp(v+w) - e_1} \{\wp(v) - \wp(w)\} = \sqrt{y-e_1}\sqrt{z-e_2}(\bar{z}-e_3) - \sqrt{z-e_1}\sqrt{y-e_2}(y-e_3)$
with two similar equations

1403. It will be noted that $\wp(v+w) - e_1$, $\wp(w+u) - e_2$, $\wp(u+v) - e_3$ are perfect squares.

1404. In the same way

$\sqrt{\wp(v-w) - e_1} \{\wp(v) - \wp(w)\} = \sqrt{y-e_1}\sqrt{z-e_2}(\bar{z}-e_3) + \sqrt{z-e_1}\sqrt{y-e_2}(y-e_3)$
with two similar equations.

1405. If $2\omega_1, 2\omega_2, 2\omega_3$ be the three periods, then

$$\omega_1 - \omega_2 + \omega_3 = 0 \quad \text{and} \quad \wp(\omega_1) = e_1, \wp(\omega_2) = e_2, \wp(\omega_3) = e_3,$$

and since $e_1 + e_2 + e_3 = 0$, we have $\wp(\omega_1) + \wp(\omega_2) + \wp(\omega_3) = 0$.

Also

$$\wp(2u) - \wp(\omega_1) = \frac{\wp^4(u) + \frac{1}{2}I\wp^2(u) + 2J\wp(u) + \frac{1}{6}I^2}{\wp'^2(u)} - e_1 \equiv \frac{Q}{\wp'^2(u)}, \text{ say,}$$

where

$$Q \equiv \wp^4(u) - 4e_1\wp^3(u) + \frac{1}{2}I\wp^2(u) + (2J + e_1I)\wp(u) + \left(\frac{1}{6}I^2 + e_1J\right).$$

Then this quartic function Q is a perfect square. For the solutions of $\wp(2u) = \wp(\omega_1)$ are given by $2u = 2\lambda\omega_1 + 2\mu\omega_2 \pm \omega_1$. That is $u = \lambda\omega_1 + \mu\omega_2$ or $u = \lambda\omega_1 + \mu\omega_2 + \omega_1$.

Now $\frac{\omega_1}{2}$ and $\frac{\omega_1}{2} + \omega_3$ are the only independent solutions, for any others are merely such that, with one or other of

these, they make a complete period. Therefore the only different factors of Q are the two

$$\wp(u) - \wp\left(\frac{\omega_1}{2}\right) \quad \text{and} \quad \wp(u) - \wp\left(\frac{\omega_1}{2} + \omega_3\right),$$

which must therefore be repeated. It is therefore indicated that

$$\wp(2u) - \wp(\omega_1) = \left[\wp(u) - \wp\left(\frac{\omega_1}{2}\right) \right]^2 \left[\wp(u) - \wp\left(\frac{\omega_1}{2} + \omega_3\right) \right]^2 / \wp'^2(u),$$

no coefficient being required, because in $\wp(2u)$ the coefficient of $\wp^4(u)$ is to be $1/\wp'^2(u)$, which is so.

The actual factorisation is given in the next article, which will show that the repetition could not be such that one factor is repeated thrice.

1406. Since

$$I = -4(e_2e_3 - e_1^2); \quad 2J + e_1I = 4e_1(e_2e_3 + e_1^2); \quad \frac{1}{18}I^2 + e_1J = (e_2e_3 + e_1^2)^2,$$

$\wp(2u) - e_1$

$$\begin{aligned} &= [\wp^4(u) - 4e_1\wp^3(u) - 2(e_2e_3 - e_1^2)\wp^2(u) + 4e_1(e_2e_3 + e_1^2)\wp(u) + (e_2e_3 + e_1^2)^2] / \wp'^2(u) \\ &= [\wp^4(u) - 2e_1\wp^3(u) - (e_2e_3 + e_1^2)^2 / \wp'^2(u) \\ &\quad - \{(\wp(u) - e_1)^2 - (e_2e_3 + 2e_1^2)\} / \wp'^2(u), \end{aligned}$$

which shows the actual factorisation of Q .

1407. The values of $\wp\left(\frac{\omega_1}{2}\right)$, $\wp\left(\frac{\omega_1}{2} + \omega_3\right)$ are therefore

$$e_1 \pm \sqrt{e_2e_3 + 2e_1^2}, \quad \text{i.e. } e_1 \pm \sqrt{3e_1^2 - \frac{1}{18}I},$$

and since $\wp\left(\frac{\omega_1}{2}\right)$ lies between e_1 and ∞ we take the positive sign for $\wp\left(\frac{\omega_1}{2}\right)$.

[See Art 1410]

1408. We have also the relations

$$\wp\left(\frac{\omega_1}{2}\right) + \wp\left(\frac{\omega_1}{2} + \omega_3\right) - 2e_1 = 2\wp(\omega_1); \quad \wp\left(\frac{\omega_1}{2}\right) \cdot \wp\left(\frac{\omega_1}{2} + \omega_3\right) = \frac{I}{4} - 2\wp^2(\omega_1)$$

with other results. For instance

$$\sqrt{\wp(2u) - e_1} = - \left[\wp(u) - \wp\left(\frac{\omega_1}{2}\right) \right] \left[\wp(u) - \wp\left(\frac{\omega_1}{2} + \omega_3\right) \right] / \wp'(u),$$

where the negative sign is chosen, because when u is very small

$$\wp(2u) = \frac{1}{4u^2}, \quad \wp(u) = \frac{1}{u^2}, \quad \wp'(u) = -\frac{2}{u^3}.$$

1409. Putting $z = e_1, e_2$ or e_3 in

$$\wp'^2(u) = 4\wp^3(u) - I\wp(u) - J = 4(z - e_1)(z - e_2)(z - e_3),$$

$$\wp'(\omega_1) = \wp'(\omega_2) = \wp'(\omega_3) = 0.$$

Then $\wp(u + \omega_1) = \frac{1}{4} \frac{\wp'^2(u)}{\{\wp(u) - \wp(\omega_1)\}^2} - \wp(u) - \wp(\omega_1);$

$$\begin{aligned} \therefore \wp(u + \omega_1) - \wp(\omega_1) &= \frac{1}{4} \frac{\wp'^2(u) - 4\{\wp(u) + 2\wp(\omega_1)\}\{\wp(u) - \wp(\omega_1)\}^2}{\{\wp(u) - \wp(\omega_1)\}^2} \\ &= \{4z^3 - Iz - J - 4(z + 2e_1)(z - e_1)^2\} / 4(z - e_1)^2 \\ &= \{(12e_1^3 - I)z - (J + 8e_1^3)\} / 4(z - e_1)^2, \end{aligned}$$

and $12e_1^3 - I = 4(e_1 - e_2)(e_1 - e_3), \quad J + 8e_1^3 = 4e_1(e_1 - e_2)(e_1 - e_3).$

Hence $\wp(u + \omega_1) - \wp(\omega_1) = (e_1 - e_2)(e_1 - e_3) / (z - e_1), \dots\dots\dots(1)$

i.e. $\{\wp(u + \omega_1) - \wp(\omega_1)\} \{\wp(u) - \wp(\omega_1)\} = \{\wp(\omega_1) - \wp(\omega_2)\} \{\wp(\omega_1) - \wp(\omega_3)\}, \dots(2)$

with two similar results by a cyclical change of suffixes.

1410. We may therefore write the result of Art. 1394 as

$$4\wp(2u) = \wp(u) + \wp(u + \omega_1) + \wp(u + \omega_2) + \wp(u + \omega_3). \quad [M. Trip., 1888] \dots(3)$$

Other identities may be established. Thus, since

$$\wp(u + \omega_1) = e_1 + \frac{(e_1 - e_2)(e_1 - e_3)}{z - e_1},$$

we have $\wp'(u + \omega_1) = \frac{(e_3 - e_1)(e_1 - e_2)}{(z - e_1)^2} \wp'(u),$

i.e. $\wp'(u + \omega_1) = \frac{\{\wp(\omega_3) - \wp(\omega_1)\} \{\wp(\omega_1) - \wp(\omega_2)\}}{\{\wp(u) - \wp(\omega_1)\}^2} \wp'(u).$

If in (1) we put $u = -\frac{1}{2}\omega_1,$

$$z = \wp\left(\frac{\omega_1}{2}\right) \quad \text{and} \quad \wp\left(\frac{\omega_1}{2}\right) - e_1 = \pm \sqrt{(e_1 - e_2)(e_1 - e_3)}. \quad (\text{See Art 1407.})$$

Now $2\omega_1 = 2 \int_{e_1}^{\infty} \frac{dz}{\sqrt{4z^3 - Iz - J}}$ and is real; and as z increases from e_1 to $\infty,$ u decreases from ω_1 to 0 and passes the value $\omega_1/2$ in the interval. Hence the value of z corresponding to $\frac{\omega_1}{2},$ that is $\wp\left(\frac{\omega_1}{2}\right),$ lies between e_1 and $\infty,$ and is therefore $> e_1.$ Hence we take the positive sign, and

$$\wp\left(\frac{\omega_1}{2}\right) = e_1 + \sqrt{(e_1 - e_2)(e_1 - e_3)}.$$

Also, since $\wp'(u) = -\sqrt{4(z - e_1)(z - e_2)(z - e_3)},$ we have

$$\begin{aligned} \wp'\left(\frac{\omega_1}{2}\right) &= -\sqrt{4\{\sqrt{(e_1 - e_2)(e_1 - e_3)}\} \{e_1 - e_2 + \sqrt{(e_1 - e_2)(e_1 - e_3)}\} \{e_1 - e_3 + \sqrt{(e_1 - e_2)(e_1 - e_3)}\}} \\ &= -2\sqrt{(e_1 - e_2)(e_1 - e_3)}[\sqrt{e_1 - e_2} + \sqrt{e_1 - e_3}]. \end{aligned}$$

1411. It may also be shown that

$$\wp\left(\frac{\omega_3}{2}\right) = e_3 - \sqrt{(e_1 - e_2)(e_2 - e_3)}, \quad \wp'\left(\frac{\omega_3}{2}\right) = e_2 - \iota\sqrt{(e_1 - e_2)(e_2 - e_3)},$$

$$\wp'\left(\frac{\omega_3}{2}\right) = -2\iota\sqrt{(e_1 - e_2)(e_2 - e_3)}[\sqrt{e_1 - e_3} + \sqrt{e_2 - e_3}],$$

$$\wp\left(\frac{\omega_2}{2}\right) = 2\sqrt{(e_1 - e_2)(e_2 - e_3)}[\sqrt{e_1 - e_2} + \iota\sqrt{e_2 - e_3}].$$

1412. Again

$$\wp'(u + \omega_2) = \frac{(e_1 - e_2)(e_2 - e_3)}{(z - e_2)^2} \wp'(u), \quad \wp'(u + \omega_3) = \frac{(e_2 - e_3)(e_3 - e_1)}{(z - e_3)^2} \wp'(u).$$

Therefore

$$\wp'(u)\wp'(u + \omega_1)\wp'(u + \omega_2)\wp'(u + \omega_3) = 16(e_2 - e_3)^2(e_3 - e_1)^2(e_1 - e_2)^2,$$

and

$$\therefore \frac{\wp''(u)}{\wp'(u)} + \frac{\wp''(u + \omega_1)}{\wp'(u + \omega_1)} + \frac{\wp''(u + \omega_2)}{\wp'(u + \omega_2)} + \frac{\wp''(u + \omega_3)}{\wp'(u + \omega_3)} = 0.$$

1413. Also $\wp'(u) \frac{\wp(u + \omega_1)}{\wp'(u + \omega_1)} = \frac{e_1(e_2 - e_3)}{(e_2 - e_3)(e_3 - e_1)(e_1 - e_2)}(z - e_1)^2 - (z - e_1)$, with two similar results.

$$\therefore \text{adding} \quad \wp'(u) \left\{ \frac{\wp(u + \omega_1)}{\wp'(u + \omega_1)} + \dots \right\} = -z = -\wp(u);$$

whence

$$\frac{\wp(u)}{\wp'(u)} + \frac{\wp(u + \omega_1)}{\wp'(u + \omega_1)} + \frac{\wp(u + \omega_2)}{\wp'(u + \omega_2)} + \frac{\wp(u + \omega_3)}{\wp'(u + \omega_3)} = 0.$$

1414. WEIERSTRASSIAN PERIODS IN TERMS OF LEGENDRIAN.

We have now to examine the relationship between the Legendrian and Weierstrassian systems. Taking e_1, e_2, e_3 as the roots of $4z^3 - Iz - J = 0$, and supposing them all real and $e_1 > e_2 > e_3$, the period $2\omega_1$ is defined as

$$2 \int_{e_1}^{\infty} \frac{dz}{\sqrt{4(z - e_1)(z - e_2)(z - e_3)}},$$

and is a *real* period ($z > e_1 > e_2 > e_3$).

$$\text{Let} \quad z - e_1 = (e_1 - e_3) \cot^2 \theta \quad \text{and} \quad k^2 = \frac{e_2 - e_3}{e_1 - e_3},$$

which is positive and < 1 .

$$\begin{aligned} \text{Then} \quad z - e_2 &= e_1 - e_2 + (e_1 - e_3) \cot^2 \theta = (e_1 - e_3) \operatorname{cosec}^2 \theta - (e_2 - e_3) \\ &= (e_1 - e_3)(1 - k^2 \sin^2 \theta) \sin^2 \theta, \end{aligned}$$

and $z - e_3 = (e_1 - e_3)/\sin^2 \theta$; also $dz = -2(e_1 - e_3) \operatorname{cosec}^2 \theta \cot \theta d\theta$.

Again $z = e_1$ gives $\theta = \pi/2$ and $z = \infty$ gives $\theta = 0$;

$$\begin{aligned} \therefore 2\omega_1 &= 2 \int_0^{\pi/2} \frac{2(e_1 - e_3) \operatorname{cosec}^2 \theta \cot \theta \sin^2 \theta d\theta}{(e_1 - e_3)^{3/2} \cot \theta \sqrt{1 - k^2 \sin^2 \theta}} \\ &= \frac{2}{\sqrt{e_1 - e_3}} \int_0^{\pi/2} \frac{d\theta}{\sqrt{1 - k^2 \sin^2 \theta}} = \frac{2K}{\sqrt{e_1 - e_3}}. \end{aligned}$$

Again (z real, and passing below $z = e_1$, see Art. 1335),

$$\begin{aligned} 2\omega_2 &= 2 \int_{e_2}^{\infty} \frac{dz}{\sqrt{4(z - e_1)(z - e_2)(z - e_3)}} \\ &= 2 \left\{ \int_{e_2}^{e_1} + \int_{e_1}^{\infty} \right\} \frac{dz}{\sqrt{4(z - e_1)(z - e_2)(z - e_3)}}; \end{aligned}$$

$$\therefore 2(\omega_2 - \omega_1) = \frac{1}{i} \int_{e_2}^{e_1} \frac{dz}{\sqrt{(e_1 - z)(z - e_2)(z - e_3)}} \quad (e_1 > z > e_2 > e_3).$$

Let $z = e_1 \cos^2 \theta + e_2 \sin^2 \theta$.

Then $e_1 - z = (e_1 - e_2) \sin^2 \theta$, $z - e_2 = (e_1 - e_2) \cos^2 \theta$,
and $z - e_3 = (e_1 - e_3)(1 - k'^2 \sin^2 \theta)$,

where $k'^2 = \frac{e_1 - e_2}{e_1 - e_3} = 1 - \frac{e_2 - e_3}{e_1 - e_3} = 1 - k^2$,

k' being positive and < 1 . Also $dz = -2(e_1 - e_2) \sin \theta \cos \theta d\theta$.

Again $z = e_2$ gives $\theta = \frac{\pi}{2}$; $z = e_1$ gives $\theta = 0$;

$$\therefore 2(\omega_2 - \omega_1) = \frac{2}{i} \frac{1}{\sqrt{e_1 - e_3}} \int_0^{\frac{\pi}{2}} \frac{d\theta}{\sqrt{1 - k'^2 \sin^2 \theta}} = \frac{2K'}{i\sqrt{e_1 - e_3}}.$$

Finally $2\omega_3 = 2 \int_{e_3}^{\infty} \frac{dz}{\sqrt{4(z - e_1)(z - e_2)(z - e_3)}}$
 $= 2 \left\{ \int_{e_3}^{e_2} + \int_{e_3}^{\infty} \right\} \frac{dz}{\sqrt{4(z - e_1)(z - e_2)(z - e_3)}}$;

$$\therefore 2(\omega_3 - \omega_2) = 2 \int_{e_3}^{e_2} \frac{dz}{i^2 \sqrt{4(e_1 - z)(e_2 - z)(z - e_3)}} \quad (e_1 > e_2 > z > e_3).$$

Let $z = e_2 \sin^2 \theta + e_3 \cos^2 \theta$;

$$\therefore e_1 - z = e_1 - e_2 \sin^2 \theta - e_3(1 - \sin^2 \theta) = (e_1 - e_3)(1 - k^2 \sin^2 \theta),$$

$$e_2 - z = (e_2 - e_3) \cos^2 \theta, \quad z - e_3 = (e_2 - e_3) \sin^2 \theta,$$

$$dz = 2(e_2 - e_3) \sin \theta \cos \theta d\theta;$$

$z = e_3$ gives $\theta = 0$, $z = e_2$ gives $\theta = \frac{\pi}{2}$;

$$\therefore 2(\omega_3 - \omega_2) = \frac{2}{i^2 \sqrt{e_1 - e_3}} \int_0^{\frac{\pi}{2}} \frac{d\theta}{\sqrt{1 - k^2 \sin^2 \theta}} = \frac{2K}{\sqrt{e_1 - e_3}}.$$

Hence $\omega_1 = \frac{K}{\sqrt{e_1 - e_3}}$, $\omega_2 = \frac{K - iK'}{\sqrt{e_1 - e_3}}$, $\omega_3 = \frac{-iK'}{\sqrt{e_1 - e_3}}$,

and $\omega_1 - \omega_2 + \omega_3 = 0$, as it should be.

1415. CONNECTION BETWEEN THE JACOBIAN AND WEIERSTRASSIAN ELLIPTIC FUNCTIONS.

In general, taking

$$u = \int_z^{\infty} \frac{dz}{\sqrt{4(z - e_1)(z - e_2)(z - e_3)}} \quad (e_1 > e_2 > e_3).$$

Put $z = e_1 + (e_1 - e_3) \cot^2 \theta$, and we have

$$u = \frac{1}{\sqrt{e_1 - e_3}} \int_0^{\theta} \frac{d\theta}{\sqrt{1 - k^2 \sin^2 \theta}}, \quad \text{where } k^2 = \frac{e_2 - e_3}{e_1 - e_3}.$$

Then $\theta = \text{am } \sqrt{e_1 - e_3} u,$

$$\wp(u) = e_1 + (e_1 - e_3) \cot^2 \theta = e_3 + \frac{e_1 - e_3}{\sin^2 \theta} = e_2 + \frac{e_1 - e_3}{\sin^2 \theta} \left(1 - \frac{e_2 - e_3}{e_1 - e_3} \sin^2 \theta \right),$$

i.e.

$$\begin{aligned} \wp(u) &= e_1 + (e_1 - e_3) \frac{\text{cn}^2 \sqrt{e_1 - e_3} u}{\text{sn}^2 \sqrt{e_1 - e_3} u}, \\ \wp(u) &= e_2 + (e_1 - e_3) \frac{\text{dn}^2 \sqrt{e_1 - e_3} u}{\text{sn}^2 \sqrt{e_1 - e_3} u}, \\ \wp(u) &= e_3 + (e_1 - e_3) \frac{1}{\text{sn}^2 \sqrt{e_1 - e_3} u}, \end{aligned} \dots\dots\dots (A)$$

which may also be written as

$$\begin{aligned} \text{sn}^2 \sqrt{e_1 - e_3} u &= \frac{e_1 - e_3}{\wp(u) - e_3}, & \text{cn}^2 \sqrt{e_1 - e_3} u &= \frac{\wp(u) - e_1}{\wp(u) - e_3}, \\ \text{dn}^2 \sqrt{e_1 - e_3} u &= \frac{\wp(u) - e_2}{\wp(u) - e_3}, \end{aligned} \dots\dots\dots (B)$$

which show the connection between the Jacobian and Weierstrassian systems.

1416. **Expansion of $\wp(u)$ in Powers of u .**

Taking $u = \int_z^\infty \frac{dz}{\sqrt{4z^3 - Iz - J}}$, and $z > e_1 > e_2 > e_3$, we have

$$\begin{aligned} u &= \int_z^\infty \frac{dz}{2z^{\frac{3}{2}} \left[1 - \frac{1}{4} \left(\frac{I}{z^2} + \frac{J}{z^3} \right) \right]^{\frac{1}{2}}} dz, \text{ and a convergent expansion,} \\ u &= \int_z^\infty \frac{dz}{2z^{\frac{3}{2}} \left[1 + \frac{1}{2} \cdot \frac{1}{4} \left(\frac{I}{z^2} + \frac{J}{z^3} \right) + \frac{1}{2} \cdot \frac{1}{4} \cdot \frac{1}{4} \left(\frac{I}{z^2} + \frac{J}{z^3} \right)^2 + \dots \right]} \\ &= \int_z^\infty dz \left[\frac{1}{2z^{\frac{3}{2}}} + \frac{I}{2^2 \cdot 4} \frac{1}{z^{\frac{5}{2}}} + \frac{J}{2 \cdot 4} \frac{1}{z^{\frac{7}{2}}} + \frac{1 \cdot 3}{2^2 \cdot 4^3} \frac{I^2}{z^{\frac{9}{2}}} + \dots \right] \\ &= \frac{1}{z^{\frac{1}{2}}} + 0 + \frac{I}{2 \cdot 4} \frac{1}{z^{\frac{5}{2}}} + \frac{J}{2 \cdot 4 \cdot 7} \frac{1}{z^{\frac{7}{2}}} + \frac{1 \cdot 3}{2 \cdot 4^3 \cdot 9} \frac{I^2}{z^{\frac{9}{2}}} + \dots \end{aligned}$$

We have to reverse this series, and expand z in powers of u . Squaring, we notice that u^2 is a rational function of z , viz.

$$u^2 = \frac{1}{z} + 0 + \frac{I}{4 \cdot 5} \frac{1}{z^3} + \frac{J}{4 \cdot 7} \frac{1}{z^4} + \dots$$

Then

$$\begin{aligned} z &= \frac{1}{u^2} + 0 + \frac{I}{20} \frac{1}{u^2 \cdot 2} + \frac{J}{28} \frac{1}{u^2 \cdot 3} + \dots \\ &= \frac{1}{u^2} + 0 + \frac{I}{20} u^2 + \frac{J}{28} u^4 + \dots \text{ to the first three terms.} \end{aligned}$$

As z is obviously an even function of u , we may conclude that the expansion is of the form

$$z = \frac{1}{u^2} + 0 + \frac{I}{20} u^2 + \frac{J}{28} u^4 + \frac{A_6}{6!} u^6 + \frac{A_8}{8!} u^8 + \frac{A_{10}}{10!} u^{10} + \dots,$$

where A_6, A_8, \dots remain to be found. As the work of reversion of series

is somewhat laborious, we may now use the differential equation $z''' = 12zz'$ (Art. 1384) to determine the coefficients from this point.

$$\text{Now } z' = -\frac{1 \cdot 2}{u^3} + 0 + \frac{I}{10} u + \frac{J}{7} u^3 + \frac{A_6}{5!} u^5 + \frac{A_8}{7!} u^7 + \frac{A_{10}}{9!} u^9 + \dots,$$

$$z'' = -\frac{1 \cdot 2 \cdot 3 \cdot 4}{u^5} + 0 + 0 + \frac{2 \cdot 3J}{7} u + \frac{A_6}{3!} u^3 + \frac{A_8}{5!} u^5 + \frac{A_{10}}{7!} u^7 + \dots;$$

$$\text{whence } \frac{A_6}{3!} = 12 \left(\frac{4A_6}{6!} + \frac{I^2}{200} \right), \quad \frac{A_8}{5!} = 12 \left(\frac{6A_8}{8!} + \frac{3IJ}{280} \right),$$

$$\frac{A_{10}}{7!} = 12 \left(\frac{8A_{10}}{10!} + \frac{2}{5} I \frac{A_6}{6!} + \frac{J^2}{4 \cdot 7 \cdot 2} \right), \text{ etc.},$$

$$\text{giving } \frac{A_6}{6!} = \frac{I^2}{2^4 \cdot 3 \cdot 5^2}, \quad \frac{A_8}{8!} = \frac{3IJ}{2^4 \cdot 5 \cdot 7 \cdot 11}, \quad \frac{A_{10}}{10!} = \frac{1}{2^4 \cdot 3 \cdot 13} \left(\frac{I^3}{2 \cdot 5^3} + \frac{3J^2}{7^2} \right), \text{ etc.}$$

Hence

$$\varphi(u) = \frac{1}{u^2} + 0 + \frac{I}{20} u^2 + \frac{J}{28} u^4 + \frac{I^2}{2^4 \cdot 3 \cdot 5^2} u^6 + \frac{3IJ}{2^4 \cdot 5 \cdot 7 \cdot 11} u^8 \\ + \frac{1}{2^4 \cdot 3 \cdot 13} \left(\frac{I^3}{2 \cdot 5^3} + \frac{3J^2}{7^2} \right) u^{10} + \dots$$

1417. It appears that $\varphi(u) - \frac{1}{u^2}$ vanishes with u . That is, for very small values of u , $\varphi(u) = \frac{1}{u^2}$. Also $\lim_{u \rightarrow 0} \frac{\varphi(u) - \frac{1}{u^2}}{u^2} = \frac{I}{20}$, etc.

Again $\varphi(u)\varphi'(u) + \frac{2}{u^5}$ vanishes with u .

Moreover the expansions of $\varphi'(u)$, $\varphi''(u)$, $\varphi'''(u)$, etc. are now all known to several terms.

1418. The Expansions of the Weierstrassian Zeta and Sigma Functions.

Since $\zeta(u) = -\int \wp(u) du = \frac{d}{du} \log \sigma(u)$, we have

$$\zeta(u) = \frac{1}{u} + 0 - \frac{I}{2^2 \cdot 3 \cdot 5} u^3 - \frac{J}{2^2 \cdot 5 \cdot 7} u^5 - \frac{I^2}{2^4 \cdot 3 \cdot 5^2 \cdot 7} u^7 - \frac{IJ}{2^4 \cdot 3 \cdot 5 \cdot 7 \cdot 11} u^9 \\ - \frac{1}{2^4 \cdot 3 \cdot 11 \cdot 13} \left(\frac{I^3}{2 \cdot 5^3} + \frac{3J^2}{7^2} \right) u^{11} - \dots \quad (\text{A})$$

$$\text{Also } \int \zeta(u) du = \log u + 0 - \frac{I}{2^4 \cdot 3 \cdot 5} u^4 - \frac{J}{2^3 \cdot 3 \cdot 5 \cdot 7} u^6 - \frac{I^2}{2^7 \cdot 3 \cdot 5^2 \cdot 7} u^8 \\ - \frac{IJ}{2^5 \cdot 3 \cdot 5^2 \cdot 7 \cdot 11} u^{10} - \dots;$$

whence

$$\sigma(u) = e^{\int \zeta(u) du} = u \cdot e^{-\frac{Iu^4}{2^4 \cdot 3 \cdot 5}} \cdot e^{-\frac{Ju^6}{2^3 \cdot 3 \cdot 5 \cdot 7}} \cdot e^{-\frac{I^2 u^8}{2^7 \cdot 3 \cdot 5^2 \cdot 7}} \cdot e^{-\frac{IJ u^{10}}{2^5 \cdot 3 \cdot 5^2 \cdot 7 \cdot 11}} \dots \\ = u \left[1 - \frac{Iu^4}{2^4 \cdot 3 \cdot 5} + \frac{I^2 u^8}{2^9 \cdot 3^2 \cdot 5^2} - \dots \right] \left[1 - \frac{Ju^6}{2^3 \cdot 3 \cdot 5 \cdot 7} \dots \right] \\ \times \left[1 - \frac{I^2 u^8}{2^7 \cdot 3 \cdot 5^2 \cdot 7} \dots \right] \left[1 - \frac{IJ u^{10}}{2^5 \cdot 3 \cdot 5^2 \cdot 7 \cdot 11} \dots \right],$$

$$\text{i.e. } \sigma(u) = u + 0 - \frac{Iu^6}{2^4 \cdot 3 \cdot 5} - \frac{Ju^7}{2^3 \cdot 3 \cdot 5 \cdot 7} - \frac{I^2 u^9}{2^9 \cdot 3^2 \cdot 5 \cdot 7} - \frac{IJ u^{11}}{2^7 \cdot 3^2 \cdot 5^2 \cdot 7 \cdot 11} - \dots \quad (\text{B})$$

Equations (A) and (B) give the expansions of the Zeta and Sigma functions.

The constants of integration are in both cases taken zero. That is, $\zeta(u) - \frac{1}{u}$ and $\log \frac{\sigma(u)}{u}$ are taken as vanishing with u .

1419. We note that both $\zeta(u)$ and $\sigma(u)$ are odd functions of u , and that in consequence $\zeta(-u) = -\zeta(u)$, $\sigma(-u) = -\sigma(u)$.

Also that $\zeta(0) = \infty$, $\zeta'(0) = \infty$, $\zeta''(0) = \infty$, etc.,

$$\sigma(0) = 0, \quad \sigma'(0) = 1, \quad \sigma''(0) = 0, \quad \sigma'''(0) = 0, \quad \sigma^{(4)}(0) = 0,$$

$$\sigma^{(5)}(0) = -\frac{1}{2}I, \text{ etc.,}$$

and for small values of u , $\zeta(u) = \frac{1}{u}$, $\sigma(u) = u$.

1420. ADDITION FORMULA FOR THE ZETA FUNCTION.

Integrating the equation

$$\varphi(u-v) \cdot \varphi(u+v) = \frac{\varphi'(u)\varphi'(v)}{\{\varphi(u) - \varphi(v)\}^2}$$

with respect to v , $\zeta(u-v) + \zeta(u+v) = \frac{\varphi'(u)}{\varphi(u) - \varphi(v)} + C$;

and putting $v=0$, $\varphi(v) = \infty$; $\therefore 2\zeta(u) = C$;

$$\therefore \zeta(u-v) + \zeta(u+v) - 2\zeta(u) = \frac{\varphi'(u)}{\varphi(u) - \varphi(v)} \dots\dots\dots(1)$$

Also $\zeta(u)$ being an odd function, $\zeta(u-v) = -\zeta(v-u)$.

Hence, interchanging u and v in equation (1),

$$-\zeta(u-v) + \zeta(u+v) - 2\zeta(v) = -\frac{\varphi'(v)}{\varphi(u) - \varphi(v)} \dots\dots\dots(2)$$

Hence adding,

$$\begin{aligned} \zeta(u+v) - \zeta(u) - \zeta(v) &= \frac{1}{2} \frac{\varphi'(u) - \varphi'(v)}{\varphi(u) - \varphi(v)} \dots\dots\dots(3) \\ &= \{\varphi(u+v) + \varphi(u) + \varphi(v)\}^{\frac{1}{2}}, \end{aligned}$$

or writing $u+v = -w$ and remembering that

$$\begin{aligned} \varphi(-w) &= \varphi(w), \quad \zeta(-w) = -\zeta(w), \\ \zeta(u) + \zeta(v) + \zeta(w) + \sqrt{\varphi(u) + \varphi(v) + \varphi(w)} &= 0, \end{aligned}$$

where $u+v+w=0$. [See Greenhill, *E.F.*, p. 205.]

Changing the sign of v in (3),

$$\zeta(u-v) - \zeta(u) + \zeta(v) = \frac{1}{2} \frac{\varphi'(u) + \varphi'(v)}{\varphi(u) - \varphi(v)} \dots\dots\dots(4)$$

1421. By differentiating (3) and (4) with regard to u ,

$$\frac{d}{du} \zeta(u+v) - \frac{d}{du} \zeta(u) = \frac{1}{2} \frac{d}{du} \frac{\wp'(u) - \wp'(v)}{\wp(u) - \wp(v)}$$

and
$$\frac{d}{du} \zeta(u-v) - \frac{d}{du} \zeta(u) = \frac{1}{2} \frac{d}{du} \frac{\wp'(u) + \wp'(v)}{\wp(u) - \wp(v)},$$

whence
$$\wp(u) - \wp(u+v) = \frac{1}{2} \frac{d}{du} \frac{\wp'(u) - \wp'(v)}{\wp(u) - \wp(v)},$$

$$\wp(u) - \wp(u-v) = \frac{1}{2} \frac{d}{du} \frac{\wp'(u) + \wp'(v)}{\wp(u) - \wp(v)}.$$

1422. ADDITION FORMULA FOR THE SIGMA FUNCTION.

Integrating $\zeta(u-r) + \zeta(u+r) - 2\zeta(u) = \frac{\wp'(u)}{\wp(u) - \wp(r)}$ with regard to u ,

$$\log \sigma(u-v) + \log \sigma(u+v) - 2 \log \sigma(u) = \log \{ \wp(u) - \wp(v) \} + C;$$

and since, when u is indefinitely small,

$$\sigma(u) = u \quad \text{and} \quad \wp(u) = \frac{1}{u^2},$$

$$\log \sigma(-v) + \log \sigma(v) = \lim_{u \rightarrow 0} \log u^2 \left\{ \frac{1}{u^2} - \wp(v) \right\} + C = C;$$

whence

$$\log \frac{\sigma(v-u)}{\sigma(v)} + \log \frac{\sigma(v+u)}{\sigma(v)} - 2 \log \sigma(u) = \log \{ \wp(u) - \wp(v) \}, \quad (1)$$

i.e.
$$\frac{\sigma(v-u) \sigma(v+u)}{\sigma^2(u) \sigma^2(v)} = \wp(u) - \wp(v)$$

and
$$\frac{\sigma(u-r) \sigma(u+r)}{\sigma^2(u) \sigma^2(v)} = \wp(v) - \wp(u). \quad \dots \dots \dots (2)$$

Putting $v = nu$, we have

$$\wp(nu) - \wp(u) = - \frac{\sigma(n-1)u \sigma(n+1)u}{\sigma^2(nu) \sigma^2(u)}.$$

1423. If we integrate with regard to v instead of with regard to u , we have

$$- \log \sigma(u-v) + \log \sigma(u+v) - 2v\zeta(u) = \int_0^v \frac{\wp'(u)}{\wp(u) - \wp(v)} dv;$$

whence
$$\log e^{-2v\zeta(u)} \frac{\sigma(u+v)}{\sigma(u-v)} = \int_0^v \frac{\wp'(u)}{\wp(u) - \wp(v)} dv. \quad \dots \dots \dots (3)$$

1424. Starting with

$$-\zeta(u-v) + \zeta(u+v) - 2\zeta(v) = -\frac{\wp'(v)}{\wp(u) - \wp(v)},$$

and integrating with regard to u ,

$$-\log \sigma(v-u) + \log \sigma(u+v) - 2u\zeta(v) = -\int_0^u \frac{\wp'(v)}{\wp(u) - \wp(v)} du;$$

whence
$$\log e^{-2u\zeta(v)} \frac{\sigma(v+u)}{\sigma(v-u)} = -\int_0^u \frac{\wp'(v)}{\wp(u) - \wp(v)} du. \dots\dots(4)$$

1425. Since $\frac{d^2 \log \sigma(u)}{du^2} = \frac{d\zeta(u)}{du} = -\wp(u)$, we have

$$\frac{\sigma(u-v)\sigma(u+v)}{\sigma^2(u)\sigma^2(v)} = \frac{d^2}{du^2} \log \sigma(u) - \frac{d^2}{dv^2} \log \sigma(v). \dots\dots(5)$$

1426. In the result

$$\frac{\sigma(u-v)\sigma(u+v)}{\sigma^2(u)\sigma^2(v)} = \wp(v) - \wp(u),$$

make v approach indefinitely closely to u . Then

$$\frac{\sigma(2u)}{\sigma^4(u)} = \lim_{v \rightarrow u} \frac{\wp(v) - \wp(u)}{\sigma(u-v)} = \lim_{v \rightarrow u} \frac{\wp'(v)}{-\sigma'(u-v)} = -\wp'(u),$$

for $\sigma'(0) = 1$ (Art. 1419). Hence

$$\sigma(2u) = -\sigma^4(u)\wp'(u) = (-1)^1 \sigma^{2^2}(u)\wp'(u).$$

1427. Differentiating $\wp(2u) - \wp(u) = -\frac{1}{4} \frac{d^2}{du^2} \log \wp'(u)$, we have

$$2\wp'(2u) - \wp'(u) = -\frac{1}{4} \frac{d^3}{du^3} \log \wp'(u), \text{ etc.,}$$

$$2^n \wp^{(n)}(2u) - \wp^{(n)}(u) = -\frac{1}{4} \frac{d^{n+2}}{du^{n+2}} \log \wp'(u).$$

Integrating the same equation,

$$-\frac{1}{2}\zeta(2u) + \zeta(u) + C = -\frac{1}{4} \frac{d}{du} \log \wp'(u) = -\frac{1}{4} \frac{\wp''(u)}{\wp'(u)},$$

and taking u indefinitely small, we have in the limit

$$-\frac{1}{2} \cdot \frac{1}{2u} + \frac{1}{u} + C = -\frac{1}{4} \cdot \frac{\frac{2}{u^3} + \frac{1}{10}I}{-\frac{2}{u^4}} = \frac{3}{4u}; \therefore C = 0;$$

whence

$$-\frac{1}{2}\zeta(2u) + \zeta(u) = -\frac{1}{4} \frac{\wp''(u)}{\wp'(u)}.$$

Again integrating $-\frac{1}{4} \log \sigma(2u) + \log \sigma(u) + C' = -\frac{1}{4} \log \wp'(u)$, and diminishing u indefinitely,

$$-\frac{1}{4} \log 2u + \log u + C' = -\frac{1}{4} \log \left(-\frac{2}{u^3} \right) = \frac{3}{4} \log u - \frac{1}{4} \log 2 - \frac{1}{4} \log(-1);$$

$$\therefore C' = -\frac{1}{4} \log(-1);$$

$$\therefore \log \frac{\sigma^4(u)}{\sigma(2u)} = \log \frac{-1}{\wp'(u)}, \text{ i.e. } \sigma(2u) = -\sigma^4(u)\wp'(u), \text{ as found before.}$$

1428. Putting $n=2$ in the formula

$$\wp(nu) - \wp(u) = -\frac{\sigma(n+1)u\sigma(n-1)u}{\sigma^2(nu)\sigma^2(u)},$$

we have $\frac{\sigma(3u)\sigma(u)}{\sigma^2(2u)\sigma^2(u)} = \wp(u) - \wp(2u) = \frac{1}{4} \frac{d^2}{du^2} \log \wp'(u)$;

$$\therefore \sigma(3u) = \frac{1}{4} \sigma^2(u) \wp^2(u) \frac{d^2}{du^2} \log \wp'(u) = \frac{(-1)^2 \sigma^2(u)}{(1! 2!)^2} \left| \begin{matrix} \wp'(u), \wp''(u) \\ \wp''(u), \wp'''(u) \end{matrix} \right|.$$

1429. To find $\sigma(4u)$, we have

$$\begin{aligned} \sigma(4u) &= -\sigma^4(2u)\wp'(2u) = -[\sigma^4(u)\wp'(u)]^4 \wp'(2u) \\ &= -\sigma^{12}(u) \cdot \wp'^4(u) \wp'(2u), \end{aligned}$$

and by aid of these results we might proceed to find $\sigma(5u)$, $\sigma(6u)$, etc.

1430. Corresponding to Euler's Theorem,

$$\cos \theta \cos 2\theta \cos 2^2\theta \dots \cos 2^{n-1}\theta = \sin 2^n\theta / 2^n \sin \theta,$$

we have $\frac{\sigma(2^n u)}{\sigma^4(2^{n-1}u)} = -\wp'(2^{n-1}u)$, $\frac{\sigma(2^{n-1}u)}{\sigma^4(2^{n-2}u)} = -\wp'(2^{n-2}u)$, ...

$$\frac{\sigma(2^2 u)}{\sigma^4(2u)} = -\wp'(2u), \quad \frac{\sigma(2u)}{\sigma^4(u)} = -\wp'(u);$$

whence $\frac{\sigma(2^n u)}{\sigma^{4^n}(u)} = -\wp'(2^{n-1}u) \cdot \wp'^4(2^{n-2}u) \cdot \wp'^{4^2}(2^{n-3}u) \dots \wp'^{4^{n-1}}(u)$.

1431. Writing ψ_n for $\frac{\sigma(nu)}{(\sigma u)^{n^2}}$, we have

$$\begin{aligned} \frac{\psi_{n-1}\psi_{n+1}}{\psi_n^2} &= \frac{\sigma(n-1)u}{(\sigma u)^{(n-1)^2}} \cdot \frac{\sigma(n+1)u}{(\sigma u)^{(n+1)^2}} \cdot \left\{ \frac{(\sigma u)^{n^2}}{\sigma(nu)} \right\}^2 = \frac{\sigma(n-1)u\sigma(n+1)u}{\sigma^2(nu)\sigma^2(u)} \\ &= \wp(u) - \wp(nu); \\ \therefore \wp(nu) - \wp(u) &= -\frac{\psi_{n-1}\psi_{n+1}}{\psi_n^2}. \end{aligned}$$

The value of $\psi_n(u)$ found by Schwarz has been shown in Art. 1398, expressed in terms of differential coefficients of $\wp(u)$.

Supposing the functions R_n to have been found in terms of $\wp(u)$ as explained in Art. 1399, etc., ψ_n can also be expressed in the same manner.

For

$$\frac{\psi_n\psi_{n-2}}{\psi_{n-1}^2} = -R_{n-1}, \quad \frac{\psi_{n-1}\psi_{n-3}}{\psi_{n-2}^2} = -R_{n-2}, \dots, \frac{\psi_4\psi_2}{\psi_3^2} = R_3, \quad \frac{\psi_3\psi_1}{\psi_2^2} = \dots R_2;$$

$$\begin{aligned} \therefore \left(\frac{\psi_n\psi_{n-2}}{\psi_{n-1}^2} \right)^1 \left(\frac{\psi_{n-1}\psi_{n-3}}{\psi_{n-2}^2} \right)^2 \left(\frac{\psi_{n-2}\psi_{n-4}}{\psi_{n-3}^2} \right)^3 \dots \left(\frac{\psi_4\psi_2}{\psi_3^2} \right)^{n-3} \left(\frac{\psi_3\psi_1}{\psi_2^2} \right)^{n-2} \\ = (-1)^{\binom{n-2}{2} + \binom{n-3}{2} + \dots + 1} R_{n-1} R_{n-2}^2 \cdot R_{n-3}^3 \dots R_3^{n-3} R_2^{n-2}, \end{aligned}$$

and $\psi_2 = \frac{\sigma(2u)}{\sigma^2(u)} = -\wp'(u)$, $\psi_1 = 1$; whence ($n > 2$)

$$\frac{\psi_n}{\psi_{n-1}^2} = (-1)^{\binom{n-2}{2} + \binom{n-1}{2}} R_{n-1} R_{n-2}^2 R_{n-3}^3 \dots R_3^{n-3} R_2^{n-2};$$

$$\therefore \psi_n = (-1)^{\frac{n(n-1)}{2}} \{\varphi'(u)\}^{n-1} R_{n-1} R_{n-2}^2 R_{n-3}^3 \dots R_2^{n-3} R_1^{n-2},$$

i.e. $\frac{\sigma(nu)}{\{\sigma(u)\}^{n^2}} = (-1)^{n-1} \{\varphi'(u)\}^{n-1} (\varphi u - \varphi 2u)^{n-2} (\varphi u - \varphi 3u)^{n-3} \dots (\varphi u - \varphi \overline{n-1} u)^1.$

1432. **General Form of the Differential Coefficients of $\varphi(u)$ with regard to u .**

Writing P, P_1, P_2 , etc., for $\varphi(u), \varphi'(u), \varphi''(u)$, etc., for short, we have

$$\begin{aligned} P_1^2 &= 4P^3 - IP - J, \\ P_2 &= 6I^2 - \frac{1}{2}I, & P_3 &= 12PP_1, \\ P_4 &= 12P_1^2 + 12PP_2 \\ &= aI^3 + bP + c, \text{ say,} & P_5 &= (3aP^2 + b)P_1, \\ P_6 &= 6aPP_1^2 + (3aP^2 + b)P_2 \\ &= a_1I^4 + b_1I^2 + c_1P + d_1, \text{ say,} & P_7 &= (4a_1P^3 + 2b_1P + c_1)P_1, \\ P_8 &= (12a_1I^2 + 2b_1)P_1^2 + (4a_1P^3 + 2b_1P + c_1)P_2 \\ &= a_2P^5 + b_2P^3 + c_2I^2 + d_2P + e_2, \text{ say,} \\ & & P_9 &= (5a_2P^4 + 3b_2P^2 + 2c_2P + d_2)P_1, \\ & & & \text{etc.;} \end{aligned}$$

whence it appears

that P_2, P_4, P_6, \dots are all rational functions of P and that P_3, P_5, P_7, \dots contain an irrational factor P_1 .

If we suppose these equations solved to express the various powers of P in terms of P, P_1, P_2, \dots , we have

$$\begin{aligned} P^2 &= \frac{1}{4}(P_2 + \frac{1}{2}I), & P^3 &= \frac{1}{4}(P_4 - bP - c), \\ P^4 &= \frac{1}{a_1} \{P_6 - \frac{1}{4}b_1(P_2 + \frac{1}{2}I) - c_1P - d_1\}, \\ P^5 &= \frac{1}{a_2} \left\{ P_8 - \frac{b_2}{a} (P_4 - bP - c) - \frac{c_2}{6} (P_2 + \frac{1}{2}I) - d_2P - e_2 \right\}, \text{ etc.;} \end{aligned}$$

whence it appears that any positive integral power of P can be expressed linearly in terms of P and its differential coefficients, and that the general result will be of the form

$$P^n = AP_{2n-2} + BP_{2n-4} + CP_{2n-6} + \dots + KP_2 + LP + M,$$

in which no differential coefficient of an odd order occurs, and the coefficients are all functions of I and J not involving the variable and readily calculable in the early cases.

1433. **Integration of Rational Integral Algebraic Functions of $\varphi(u)$ with regard to u .**

It follows from the last article that

$$\int I^n du = AP_{2n-3} + BP_{2n-7} + CP_{2n-9} + \dots \\ + KP_1 + L\xi(u) + Mu + \text{a const.},$$

in which the Zeta function appears from the integration of the term LP .

Any rational integral algebraic function of $\varphi(u)$ and $\varphi'(u)$, *i.e.* of P and P_1 , can now be integrated. For if it be separated into two parts, the first containing all the even powers of $\varphi'(u)$ and the second all the odd powers, then after substitution of $4P^3 - IP - J$ for P_1^2 , we have a result of the form $\phi(P) + \chi(P)P_1$, ϕ and χ being rational integral algebraic functions of P . And when $\phi(P)$ has been expressed as explained above as a linear function of P and its differential coefficients, each term is directly integrable. And if $\chi(P)$ be expressed in powers of P each term of $\chi(P)P_1$ is directly integrable, for $\int P^r P_1 du = P^{r+1}/(r+1)$.

Moreover, since $P^r P_1 = \frac{d}{du} \left(\frac{P^{r+1}}{r+1} \right)$, which is of form

$$\frac{d}{du} (AP_{2r} + \dots + M) = AP_{2r+1} + \dots,$$

it appears that $P^r P_1$ can be expressed as a linear function of P and its differential coefficients, and that the same is true of $\chi(P)P_1$, χ being rational and integral. Thus, whatever rational algebraic functions of P , ϕ and χ may be, the integral part of $\phi(P) + \chi(P)P_1$ is expressible in the form

$$A + A_0 P + A_1 P_1 + A_2 P_2 + \dots,$$

and is integrable with respect to u and expressible in the form

$$C + Au + A_0 \xi(u) + A_1 \varphi(u) + A_2 \varphi'(u) + A_3 \varphi''(u) + \dots$$

1434. Thus, for example, to integrate $\{\varphi(u) + \varphi'(u)\}^2$ with regard to u , we have

$$\begin{aligned} (P + P_1)^2 &= P^2 + P_1^2 + 2PP_1 = 4P^3 + P^2 - IP - J + 2PP_1 \\ &= \frac{1}{2} \sigma (P_4 + 18IP + 12J) + \frac{1}{2} (P_2 + \frac{1}{2} I) - IP - J + 2PP_1 \\ &= \frac{1}{3} P_4 + \frac{1}{2} P_2 - \frac{1}{3} IP + (\frac{1}{2} I - \frac{1}{3} J) + 2PP_1; \\ \therefore \int \{\varphi(u) + \varphi'(u)\}^2 du &= C + (\frac{1}{2} I - \frac{1}{3} J)u + \frac{1}{3} I \xi(u) \\ &\quad + \frac{1}{2} \varphi'(u) + \frac{1}{2} \varphi''(u) + \frac{1}{3} \varphi'''(u). \end{aligned}$$

1435. If we differentiate equation (1) of Art. 1420 with regard to u ,

$$\xi'(u-v) + \xi'(u+v) - 2\xi'(u) = \frac{\wp''(u)}{\wp(u) - \wp(v)} - \frac{\wp'^2(u)}{[\wp(u) - \wp(v)]^2},$$

and an interchange of u and v , or a differentiation of (2) of the same article with regard to v , gives

$$\xi'(u-v) + \xi'(u+v) - 2\xi'(v) = -\frac{\wp''(v)}{\wp(u) - \wp(v)} - \frac{\wp'^2(v)}{[\wp(u) - \wp(v)]^2};$$

a further differentiation with regard to v gives

$$\begin{aligned} -\xi''(u-v) + \xi''(u+v) - 2\xi''(v) \\ = -\frac{\wp'''(v)}{\wp(u) - \wp(v)} - \frac{3\wp'(v)\wp''(v)}{[\wp(u) - \wp(v)]^2} - \frac{2\wp'^3(v)}{[\wp(u) - \wp(v)]^3}, \end{aligned}$$

etc.

Thus we can form fractions containing $[\wp(u) - \wp(v)]^2$, $[\wp(u) - \wp(v)]^3$, etc., in the denominators with no functions of u in the numerators, and this will presently be found useful (Art. 1443): and since $\xi'(u) = -\wp(u)$, we have

$$\begin{aligned} \frac{\wp'(v)}{\wp(u) - \wp(v)} &= \xi(u-v) - \xi(u+v) + 2\xi(v), \\ \frac{\wp'^2(v)}{[\wp(u) - \wp(v)]^2} &= \wp(u-v) + \wp(u+v) - 2\wp(v) - \frac{\wp''(v)}{\wp(u) - \wp(v)}, \\ \frac{2\wp'^3(v)}{[\wp(u) - \wp(v)]^3} &= -\wp'(u-v) + \wp'(u+v) - 2\wp'(v) - \frac{\wp'''(v)}{\wp(u) - \wp(v)} \\ &\quad - \frac{3\wp'(v)\wp''(v)}{[\wp(u) - \wp(v)]^2}, \end{aligned}$$

etc.

Integrating with regard to u ,

$$\begin{aligned} \wp'(v) \int \frac{du}{\wp(u) - \wp(v)} &= \log \sigma(u-v) - \log \sigma(u+v) + 2u\xi(v) + \text{const.}, \\ \wp'^2(v) \int \frac{du}{[\wp(u) - \wp(v)]^2} &= -\xi(u-v) - \xi(u+v) - 2u\wp(v) \\ &\quad - \wp''(v) \int \frac{du}{\wp(u) - \wp(v)}, \\ 2\wp'^3(v) \int \frac{du}{[\wp(u) - \wp(v)]^3} &= -\wp(u-v) + \wp(u+v) - 2u\wp'(v) \\ &\quad - \wp'''(v) \int \frac{du}{\wp(u) - \wp(v)} - 3\wp'(v)\wp''(v) \int \frac{du}{[\wp(u) - \wp(v)]^2}, \end{aligned}$$

etc.

Each such integral is therefore expressible by means of those which have preceded it, the first being completely integrated. So that all such functions as

$$\frac{1}{\varphi(u)-a}, \frac{1}{[\varphi(u)-a]^2}, \frac{1}{[\varphi(u)-a]^3}, \text{ etc.,}$$

are integrable and expressible in terms of φ , ξ or σ functions.

In the case where $\varphi(v)=e_1, e_2$ or e_3 , we have $v=\omega_1, \omega_2$ or ω_3 and $\varphi'(v)=0$.

We now have from the second result,

$$\varphi''(\omega) \int \frac{du}{\varphi(u)-e} = -\xi(u-\omega) - \xi(u+\omega) - 2eu,$$

with corresponding suffixes for e and ω , replacing the first integration above, and so on for the other cases.

And $\varphi''(\omega_1)=6e_1^2-\frac{1}{2}I=2e_2e_3+4e_1^2$, etc.

1436. As a particular case, if we put $\varphi(v)=0$, v is a constant defined by $v=\int_0^x \frac{dz}{\sqrt{4z^3-Iz-J}}$. And

$$\varphi'^2(v)=4\varphi^3(v)-I\varphi(v)-J=-J, \quad \varphi''(v)=6\varphi^2(v)-\frac{1}{2}I=-\frac{1}{2}I,$$

$$\varphi'''(v)=12\varphi(v)\varphi'(v)=0, \quad \varphi^{(4)}(v)=-12J, \text{ etc. ;}$$

whence the successive integrals $\int \frac{du}{\varphi(u)}$, $\int \varphi^2(u)$, $\int \varphi^3(u)$, etc. may be at once expressed.

1437. The integration of the function $\frac{1}{\varphi(u)-a}$ ($a \neq e_1, e_2$ or e_3) may now be effected.

Let $a=\varphi(v)$, which defines v as a certain constant, viz.

$$v \equiv \int_a^x \frac{dz}{\sqrt{4z^3-Iz-J}}, \text{ and } \varphi'(v) = \sqrt{4a^3-Ia-J}. \text{ Then}$$

$$\begin{aligned} \frac{1}{\varphi(u)-a} &= \frac{1}{2\varphi'(v)} \left[\frac{\varphi'(u)+\varphi'(v)}{\varphi(u)-\varphi(v)} - \frac{\varphi'(u)-\varphi'(v)}{\varphi(u)+\varphi(v)} \right] \\ &= \frac{1}{\varphi'(v)} [\xi(u-v) - \xi(u+v) - \xi(v)] \\ &= \frac{1}{\varphi'(v)} [\xi(u-v) - \xi(u+v) + 2\xi(v)] \quad (\text{or by Art. 1435);} \end{aligned}$$

whence

$$\int \frac{du}{\wp(u)-a} = \frac{1}{\wp'(v)} [\log \sigma(u-v) - \log \sigma(u+v) + 2u\xi(v)] + \text{const.}$$

$$= \frac{1}{\wp'(v)} \log e^{2u\xi(v)} \frac{\sigma(u-v)}{\sigma(u+v)} + \text{const.}$$

1438. Art. 1435 shows that we also have

$$\wp'^2(v) \int \frac{du}{[\wp(u)-a]^2} = -\xi(u-v) - \xi(u+v) - 2u\wp(v)$$

$$- \wp''(v) \int \frac{du}{\wp(u)-a},$$

$$2\wp'^3(v) \int \frac{du}{[\wp(u)-a]^3} = -\wp(u-v) + \wp(u+v) - 2u\wp'(v)$$

$$- \wp'''(v) \int \frac{du}{\wp(u)-a} - 3\wp'(v)\wp''(v) \int \frac{du}{\{\wp(u)-a\}^2},$$

and so on.

1439. Integrals of form $\int \frac{\wp'(u)}{\wp(u)-a} du$, $\int \frac{\wp'(u)}{\{\wp(u)-a\}^n} du$ are of course directly integrable as

$$\log[\wp(u)-a] \quad \text{and} \quad -\frac{1}{n-1} \frac{1}{[\wp(u)-a]^{n-1}}.$$

1440. Integrals of form $\int \frac{F[\wp(u)]}{\wp(u)-a} du$, where F is a rational integral algebraic function, can be integrated by expressing F in a series of form

$$A\wp^n(u) + B\wp^{n-1}(u) + \dots + K\wp(u) + L,$$

and then dividing by $\wp(u)-a$, thus reducing the integrand to the form

$$A'\wp^{n-1}(u) + B'\wp^{n-2}(u) + \dots + K' + \frac{L'}{\wp(u)-a},$$

and each of the terms of form $\lambda\wp^r(u)$ may be treated as in Art. 1433, whilst the integration of the last term is effected above.

1441. Integrals of form

$$\int \frac{F[\wp(u)] du}{[\wp(u)-a][\wp(u)-b] \dots [\wp(u)-k]}$$

follow the ordinary rules of Partial Fractions in the first

place with an integration of the several terms of the form $\Sigma \lambda \wp^r(u) + \Sigma \frac{\mu}{\wp(u) - a}$ which accrue, following the rules described above.

1442. Ex. Thus

$$\int \frac{\wp^2(u) du}{[\wp(u) - a][\wp(u) - b][\wp(u) - c]} = \int \Sigma \frac{a^2}{(\alpha - b)(\alpha - c)} \frac{1}{\wp(u) - a} du$$

$$= \Sigma \frac{a^2}{(\alpha - b)(\alpha - c)} \frac{1}{\wp'(u_1)} \log e^{2u\zeta(u_1)} \frac{\sigma(u - u_1)}{\sigma(u + u_1)},$$

where $u_1 = \int_a^{\infty} \frac{dz}{\sqrt{4z^3 - Iz - J}}$, $u_2 = \text{etc.}$, $u_3 = \text{etc.}$, and

$$\wp'(u_1) = -\sqrt{4a^3 - Ia - J}, \text{ etc.}$$

1443. GENERAL SUMMING UP. COMPLETION OF THE METHOD.

We can now consider the general case of the integration of a function of form $(A + B\sqrt{Q})/(C + D\sqrt{Q})$, where A, B, C, D are rational algebraic functions of x and Q is a rational integral algebraic function of x of degree 3 or 4, thus extending the result of Art. 318. By exactly the same process as in Art. 318, the function may be thrown into the form $\frac{U}{V} + \frac{M}{N} \cdot \frac{1}{\sqrt{Q}}$, where U, V, M, N are rational integral algebraic functions of x . The transformation $x = a_0 + \frac{\mu}{z - \eta}$ may be applied to both parts, or to the second part only, for $\int \frac{U}{V} dx$ is directly integrable in terms of x by the rules of the first seven chapters. But for the sake of uniformity in the result, let us suppose the same transformation is applied to both parts. Then, having determined μ and η so as to reduce $\frac{dx}{\sqrt{Q}}$ to the Weierstrassian form $\frac{-dz}{\sqrt{4z^3 - Iz - J}}$, let us put, as in Art. 1432, $\wp(u) = P$, $\wp'(u) = P_1$, etc., where u is $\wp^{-1}(z)$. Then U/V and M/N , which are functions of x , take the forms U'/V' and M'/N' respectively, where U', V', M', N' are rational integral algebraic functions of P , or what is the same thing, z ; and

$$\int \left(\frac{U}{V} + \frac{M}{N} \frac{1}{\sqrt{Q}} \right) dx = \int \frac{U'}{V'} \left[\frac{-\mu}{(z - \eta)^2} \right] dz + \int \frac{M'}{N'} \frac{dz}{P_1}$$

$$= \int \frac{U''}{V''} P_1 du + \int \frac{M'}{N'} du,$$

where U''/V'' replaces $-U'\mu/V'(z-\eta)^2$, and U'' , V'' are rational integral algebraic functions of z , i.e. of $\wp(u)$ or P , and M' , N' are also rational integral algebraic functions of P .

Now U''/V'' and M'/N' can both be expressed partly as an algebraic series of powers of P and partly as a series of Partial Fractions.

Suppose

$$\frac{U''}{V''} \equiv \Sigma \lambda P^r + \Sigma \frac{\mu}{(P-\beta)^s} \quad \text{and} \quad \frac{M'}{N'} \equiv \Sigma \lambda' P^r + \Sigma \frac{\mu'}{(P-\beta')^s},$$

which are the most general forms.

Then $\int P^r P_1 du = \frac{P^{r+1}}{r+1}$; $\int \frac{P_1 du}{(P-\beta)^s} = -\frac{1}{s-1} \frac{1}{(P-\beta)^{s-1}}$; and $\int \frac{P_1 du}{P-\beta} = \log(P-\beta)$, so that all the terms of $\int \frac{U''}{V''} P_1 du$ can be integrated in terms of P , i.e. of $\wp(u)$.

Also $\int P^r du$ has been shown in Art. 1432 capable of integration, and the method to be followed has been there described.

Finally, the integration of terms of the form $\int \frac{du}{P-\beta}$ or $\int \frac{du}{(P-\beta)^s}$ has been discussed in Art. 1435. The total result is therefore expressible by aid of the Weierstrassian function $\wp(u)$ and its associated Zeta and Sigma functions, and the addition formula for each has been established.

This therefore completes the theory of the integration of the most general algebraic function of nature $(A+B\sqrt{Q})/(C+D\sqrt{Q})$, where Q is of degree 3 or 4, the cases of Q being of degree 1 or 2 having been completed in Art. 318.

1444. ILLUSTRATIVE EXAMPLE.

Consider the integration

$$U \equiv \int_z^\infty \frac{z^3 dz}{(z-1)^2(z-2)\sqrt{4(z^3+1)}} \quad (2 < z < \infty).$$

Let $z = \wp(u, 0, -4)$, i.e. $\frac{dz}{\sqrt{4(z^3+1)}} = -du$; and let α, β be two constants defined by $\wp(\alpha) = 2, \wp(\beta) = 1$.

Then $\wp^2(\alpha) = 36$, $\wp^2(\beta) = 8$, $\wp''(\alpha) = 6 \cdot 2^2 = 24$, $\wp''(\beta) = 6 \cdot 1^2 = 6$, and we have

$$U = \int_0^u \left\{ 1 + \frac{8}{z-2} - \frac{4}{z-1} - \frac{1}{(z-1)^2} \right\} du.$$

Hence, by Art. 1437,

$$U = u + 8 \cdot \frac{1}{6} \log e^{2u\zeta(\alpha)} \frac{\sigma(u-\alpha)}{\sigma(u+\alpha)} - 4 \cdot \frac{1}{\sqrt{8}} \log e^{2u\zeta(\beta)} \frac{\sigma(u-\beta)}{\sigma(u+\beta)} - \frac{1}{8} \left\{ -\zeta(u-\beta) - \zeta(u+\beta) - 2u - \frac{6}{\sqrt{8}} \log e^{2u\zeta(\beta)} \frac{\sigma(u-\beta)}{\sigma(u+\beta)} \right\} + C,$$

and C is to be determined so that $U=0$ if $u=0$. Simplifying,

$$U = u + \frac{4}{3} \log e^{2u\zeta(\alpha)} \frac{\sigma(u-\alpha)}{\sigma(u+\alpha)} - \frac{13}{8\sqrt{2}} \log e^{2u\zeta(\beta)} \frac{\sigma(u-\beta)}{\sigma(u+\beta)} + \frac{1}{8} \left\{ 2\zeta(u) + \frac{\wp'(u)}{\wp(u)-1} + 2u \right\} + C;$$

and when u is diminished indefinitely,

$$0 = \frac{4}{3} \log(-1) - \frac{13}{8\sqrt{2}} \log(-1) + \frac{1}{8} Lt \left\{ \frac{2}{u} - \frac{\frac{2}{u^3}}{\frac{1}{u^2}-1} \right\} + C = \frac{4}{3} \log(-1) - \frac{13}{8\sqrt{2}} \log(-1) + C.$$

Therefore subtracting,

$$U = \frac{5}{4} u + \frac{4}{3} \log e^{2u\zeta(\alpha)} \frac{\sigma(u-\alpha)}{\sigma(u+\alpha)} - \frac{13}{8\sqrt{2}} \log e^{2u\zeta(\beta)} \frac{\sigma(\beta-u)}{\sigma(\beta+u)} + \frac{1}{4} \zeta(u) + \frac{1}{8} \frac{\wp'(u)}{\wp(u)-1},$$

where $u = \wp^{-1}(z, 0, -4)$, $\alpha = \wp^{-1}(2)$, $\beta = \wp^{-1}(1)$.

1445. For further development of this part of the Theory of Elliptic Functions, the reader must be referred to some book expressly dealing with this section of the subject, such as Professor Sir George Greenhill's treatise, where he will find a large number of very elegant applications of their use to the problems of higher Applied Mathematics, and a much more extensive account of them than space admits here.

PROBLEMS.

1. Reduce the integral

$$u \equiv \int_2^x \frac{dx}{\sqrt{4(x-2)(x-3)(2x-5)(3x-5)}} \quad (2 < x < 2.5)$$

to the Weierstrassian form, by putting $x = 2 + \frac{1}{y}$. Show that the moduli of the integral are $2/\sqrt{5}$ and $1/\sqrt{5}$, and that $u = \wp^{-1}\{1/(x-2)\}$.

Show also that $u = \frac{1}{\sqrt{5}} \operatorname{dn}^{-1} \sqrt{\frac{3-x}{3x-5}}$, mod. $\frac{2}{\sqrt{5}}$.

2. In the integral $u = \int_z^\infty \frac{dz}{\sqrt{4z^3 - 20z - 28}}$, show that if

$$z > e_1 > e_2 > e_3,$$

$$(i) \quad \wp(u) = \frac{1}{u^2} + u^2 + u^4 + \frac{1}{3}u^6 + \dots;$$

$$(ii) \quad \zeta(u) = \frac{1}{u} - \frac{1}{3}u^3 - \frac{1}{5}u^5 - \frac{1}{21}u^7 - \dots;$$

$$(iii) \quad \sigma(u) = u - \frac{1}{12}u^3 - \frac{1}{30}u^7 - \dots$$

3. If $2u = \int_1^x \frac{dx}{\sqrt{(4x^2 + 17x + 4)(2x^2 - 3x + 1)}}$, show by putting $x = y/(y-5)$

that the integral is reduced to Weierstrassian form. Prove also that

$$u = \frac{1}{\sqrt{5}} \wp^{-1}\left(\frac{5x}{x-1}, 84, -80\right) = \frac{1}{3\sqrt{5}} \operatorname{dn}^{-1}\left(\sqrt{\frac{1}{5} \frac{4x+1}{2x-1}}, \sqrt{\frac{2}{3}}\right).$$

4. Show that

$$32\wp''(u)\wp'(2u) - 64\wp^6(u) - 80I\wp^4(u) - 320J\wp^3(u) \\ - 20I^2\wp^2(u) - 16IJ\wp(u) + (I^3 - 32J^2).$$

Also show that if $2u = \int_z^\infty \frac{dz}{\sqrt{z^3 - 2z - 1}}$, $\wp'(2u)$ contains $\wp(u)$ as a factor.

5. Show that for the integral $2u = \int_x^\infty \frac{dz}{\sqrt{z^3 - a^3}}$, the roots of the equation $\wp'(2u) = 0$ are given by $\wp(u) = a(\sqrt{3} \pm 1)$, $a\omega(\sqrt{3} \pm 1)$, $a\omega^2(\sqrt{3} \pm 1)$, where ω is one of the unreal cube roots of unity.

Show also that $\wp(2u) - \wp(u) = -\frac{3}{4}z \frac{z^3 - 4a^3}{z^3 - a^3}$, and that

$$\wp'''(u) = 24\{5\wp^3(u) - 2a^3\}.$$

6. If $2u = \int_z^\infty \frac{dz}{\sqrt{z^3 - a^3}}$, show that $u = \frac{1}{2\sqrt[4]{3a^2}} \operatorname{cn}^{-1} \left\{ \frac{z - 2a\sqrt{2} \cos 15^\circ}{z + 2a\sqrt{2} \cos 15^\circ} \right\}$.

Mod. $\sin 15^\circ$.

7. For any Weierstrassian Integral, show that

(i) $Lt_{u \rightarrow 0} \left\{ \frac{u^4 \wp''(u) - 6}{u^2 \wp(u) - 1} \right\} = 2$; (ii) $Lt_{u \rightarrow 0} \left\{ \frac{u^2 \zeta'(u) - u}{\sigma(u) - u} \right\} = 4$.

8. If $u = \wp^{-1}(z, 84, -80)$, show that the values of $\wp\left(\frac{\omega_1}{2}\right)$ and $\wp\left(\frac{\omega_1}{2} + \omega_3\right)$ are $4 \pm 3\sqrt{3}$, and that

$$\wp'(u) \sqrt{\wp^2 u - 4} + \wp^2(u) - 8\wp(u) - 11 = 0.$$

Show also that

$$\begin{cases} \wp'(u + \omega_1) = -27\wp'(u) / \{\wp(u) - 4\}^2, \\ \wp'(u + \omega_2) = 18\wp'(u) / \{\wp(u) - 1\}^2, \\ \wp'(u + \omega_3) = -54\wp'(u) / \{\wp(u) + 5\}^2. \end{cases}$$

9. If $u \equiv \int_{e_1}^x \frac{dx}{\{(x - e_1)(x - e_2)(x - e_3)\}^{\frac{1}{2}}}$, transform the integral by the substitution $y^3 = \frac{(x - e_2)(x - e_3)}{(x - e_1)^2}$, and show that

$$y = \wp \left\{ \frac{u}{3} \sqrt{(e_1 - e_2)(e_1 - e_3)}, 0, \frac{4e_2 e_3 - e_1^2}{(e_1 - e_2)(e_1 - e_3)} \right\}.$$

10. Prove the relations,

(i) $\sigma^2(u)\sigma(v+w)\sigma(v-w) + \sigma^2(v)\sigma(w+u)\sigma(w-u) + \sigma^2(w)\sigma(u+v)\sigma(u-v) = 0$.

(ii) $\wp(u)\sigma^3(u)\sigma(v+w)\sigma(v-w) + \wp(v)\sigma^2(v)\sigma(w+u)\sigma(w-u) + \wp(w)\sigma^2(w)\sigma(u+v)\sigma(u-v) = 0$.

(iii) $\wp^2(u)\sigma^3(u)\sigma(v+w)\sigma(v-w) + \wp^2(v)\sigma^2(v)\sigma(w+u)\sigma(w-u) + \wp^2(w)\sigma^2(w)\sigma(u+v)\sigma(u-v) = \sigma^2(u)\sigma^2(v)\sigma^2(w)\{\wp(v) - \wp(w)\}\{\wp(w) - \wp(u)\}\{\wp(u) - \wp(v)\}$.

(iv) $\sigma(v+w)\sigma(v-w)\sigma(u+x)\sigma(u-x) + \sigma(w+u)\sigma(w-u)\sigma(v+x)\sigma(v-x) + \sigma(u+v)\sigma(u-v)\sigma(w+x)\sigma(w-x) = 0$.

[GREENHILL, *E. F.*, p. 208.]

(v) $\sigma^6(u)\sigma^3(v+w)\sigma^3(v-w) + \sigma^6(v)\sigma^3(w+u)\sigma^3(w-u) + \sigma^6(w)\sigma^3(u+v)\sigma^3(u-v) = 3\sigma^2(u)\sigma^2(v)\sigma^2(w)\sigma(v+w)\sigma(v-w)\sigma(w+u)\sigma(w-u)\sigma(u+v)\sigma(u-v)$.

11. If $u \equiv \wp^{-1}(z, I, J)$, find the values of

$$\int \wp^n(u) dz, \quad \int \frac{1}{\wp(u)} dz, \quad \int e^{\wp(u)} dz, \quad \int \frac{12\wp^2(u) - I}{\sqrt{4\wp^3(u) - I\wp(u) - J}} dz.$$

12. Find the values of

$$\int \wp^2(u) du, \quad \int \wp^3(u) du, \quad \int \wp^4(u) du, \quad \int \frac{du}{\wp(u)}, \quad \int \frac{du}{\wp^2(u)}, \quad \int \frac{du}{\wp^3(u)}.$$

13. Prove that

$$\Sigma (\wp u - e) (\wp v - \wp w)^2 [\wp(v+w) - e]^{\frac{1}{2}} [\wp(v-w) - e]^{\frac{1}{2}} = 0,$$

where the sign of summation refers to any three arguments u, v, w , and e is any one of the usual quantities e_1, e_2, e_3 .

[MATH. TRIP., 1896.]

14. Prove that

$$8\wp'(u)\wp'(2u) = \wp^2(u) - 3J\wp(u) - 18J - 4\Sigma \frac{(e_1 - e_2)^2(e_1 - e_3)^2}{\wp(u) - e_1}.$$

15. Prove that

$$\sqrt{\wp(2u) - e_1} + \sqrt{\wp(2u) - e_2} + \sqrt{\wp(2u) - e_3} = \{12\wp^2(u) - I\}/4\wp'(u).$$

16. Show that

$$4 \int \wp(2u)\wp'(u) du = \frac{1}{2}\wp^2(u) + \log(\wp u - e_1)^{\alpha_1}(\wp u - e_2)^{\alpha_2}(\wp u - e_3)^{\alpha_3},$$

where $\alpha_1 = (e_1 - e_2)(e_1 - e_3), \quad \alpha_2 = \text{etc.}, \quad \alpha_3 = \text{etc.}$

17. If $\phi(u, v) = \frac{\sigma(u+v)}{\sigma(u)\sigma(v)} e^{-u\zeta(v)}$, show that

$$(i) \quad \phi(u, v)\phi(u, -v) = \wp(u) - \wp(v);$$

$$(ii) \quad \phi(u, \omega_1) = \phi(u, -\omega_1) = \sqrt{\wp(u) - e_1}.$$

18. Putting $\frac{\sigma(u+\omega_1)}{\sigma(\omega_1)} e^{-u\zeta(\omega_1)} = \sigma_1(u)$, etc., etc., show that

$$\sigma(2u) = 2\sigma(u)\sigma_1(u)\sigma_2(u)\sigma_3(u).$$

[GREENHILL, *E. F.*, p. 208.]

19. If the function $\phi(u, v)$ be defined by the equation

$$\log \phi(u, v) = \frac{1}{2} \int_0^u \frac{\wp'(u) - \wp'(v)}{\wp(u) - \wp(v)} du,$$

show that

$$(i) \quad \phi(u, v)\phi(u, -v) = \wp(u) - \wp(v);$$

$$(ii) \quad \frac{1}{\phi} \frac{\partial \phi}{\partial u} = \zeta(u+v) - \zeta(u) - \zeta(v);$$

$$(iii) \quad \frac{1}{\phi} \frac{\partial^2 \phi}{\partial u^2} = 2\wp(u) + \wp(v).$$

Hence give the general solution of the following case of Lamé's Equation, viz.

$$\frac{1}{y} \frac{d^2 y}{du^2} = 2\wp(u) + \wp(v). \quad [\text{GREENHILL, } E. F., \text{ p. 210.}]$$

20. Prove the results

- (i) $-2 \frac{\wp'(u)\wp'(v)}{\{\wp(u) - \wp(v)\}^3} = \wp'(u+v) + \wp'(u-v) + \frac{\wp''(v)}{\wp'(v)} \{\wp(u-v) + \wp(u+v)\}$;
 (ii) $\frac{\wp''(u)\wp'(v) + \wp''(v)\wp'(u)}{\{\wp(u) - \wp(v)\}^2} - 2\wp'(u)\wp'(v) \frac{\wp'(u) - \wp'(v)}{\{\wp(u) - \wp(v)\}^3} = -2\wp'(u+v)$;
 (iii) $\frac{\wp''(u)\wp'(v) - \wp''(v)\wp'(u)}{\{\wp(u) - \wp(v)\}^2} - 2\wp'(u)\wp'(v) \frac{\wp'(u) + \wp'(v)}{\{\wp(u) - \wp(v)\}^3} = 2\wp'(u-v)$;
 (iv) $\frac{\{\wp'(v)\}^2\wp''(u) + \{\wp'(u)\}^2\wp''(v)}{\{\wp(u) - \wp(v)\}^2} = \{\wp'(v) - \wp'(u)\}\wp'(u-v) - \{\wp'(v) + \wp'(u)\}\wp'(u+v)$.

21. Obtain from the definition of the function $\wp(u)$ the formulae

$$(a) \wp(u+v) + \wp(u) + \wp(v) = m^2; \quad (b) \wp(u) - \wp(u+v) = \frac{\partial m}{\partial u},$$

where $2m = \{\wp'(u) - \wp'(v)\} / \{\wp(u) - \wp(v)\}$. [MATH. TRIP. II., 1918.]

22. Prove that

$$\int \frac{du}{\wp(u) - e_1} = -\frac{1}{e_2 e_3 + 2e_1^2} \left[e_1 u + \zeta(u) + \frac{1}{2} \frac{\wp'(u)}{\wp(u) - e_1} \right].$$

23. Prove that $\sigma_\lambda(2u) + \sigma_\mu(2u) - 2\sigma_\lambda(u)\sigma_\mu(u)$, where λ, μ are any two of the integers 1, 2, 3. [MATH. TRIP., 1890.]

24. If $\wp(u) = \wp(u+\sigma) + \wp(u) - e$, $\sigma = e' - e''$, prove that

$$\frac{\sigma}{\wp(u) + 2e} + \frac{e - e'}{\wp(u) - e'} - \frac{e - e''}{\wp(u) - e''} = 0$$

and

$$[\wp'(u)]^2 = 4(\wp(u) - E_1)(\wp(u) - E_2)(\wp(u) - E_3),$$

where E_1, E_2, E_3 are respectively $e \pm (9e^2 - \sigma^2)^{\frac{1}{2}}$ and $-2e$.

[MATH. TRIP. II., 1919.]

25. Show that the function $\{\wp(u) - e_1\}^{\frac{1}{2}}$ is a single-valued function of u , and obtain its periods and its addition equation.

[MATH. TRIP. II., 1918.]

26. If $u \equiv \int_a^\phi \frac{d\phi}{\{(\sin \phi - \sin a)(1 - \sin \beta \sin \phi)\}^{\frac{1}{2}}}$, verify that $\sin \phi$ is expressible as a single-valued function of u in the form

$$(\sin \phi - \sin a) / (\sin \phi + 1) = \frac{1}{2}(1 - \sin a) \sin^2(\gamma u, k),$$

where

$$\gamma^2 = \frac{1}{2}(1 - \sin a \sin \beta), \quad k^2 = \frac{1}{2}(1 - \sin a)(1 + \sin \beta) / (1 - \sin a \sin \beta).$$

[MATH. TRIP. II., 1918.]

27. State the properties of the elliptic function $\wp(u)$, which prove that there is a single-valued function $a(u)$, such that $a^2(u) = \wp(u) - e_1$ and $ua(u) = 1$ when $u = 0$.

Defining similarly $b(u) = \{\wp(u) - e_2\}^{\frac{1}{2}}$, $c(u) = \{\wp(u) - e_3\}^{\frac{1}{2}}$, prove that

$$a(u+v) = \frac{a(u)b(v)c(v) - a(v)b(u)c(u)}{a^2(v) - a^2(u)}.$$

[MATH. TRIP. II., 1916.]

28. With the notation of the last question, show that if

$$a'(u) = \frac{da(u)}{du},$$

- (i) $a(u + \omega) a(u) = a'(\omega) = -a^2(\frac{1}{2}\omega)$;
- (ii) $2a(u) b(u) c(u) a(2u) = a^4(u) - a^4(\frac{1}{2}\omega)$;
- (iii) $\int_0^u \left\{ \frac{1}{u} - a(u) \right\} du = \log \left[\frac{1}{2} u \{ b(u) + c(u) \} \right]$.

[MATH. TRIP. II., 1916.]

29. Prove that

- (i) $\wp(\frac{1}{2}\omega) + \wp(\frac{1}{2}\omega + \omega') = 2e_1$;
- (ii) $\wp(\frac{1}{2}\omega) - \wp(\frac{1}{2}\omega + \omega') = 2 \{ (e_1 - e_2)(e_1 - e_3) \}^{\frac{1}{2}}$;
- (iii) $\wp'(\frac{1}{2}\omega) = -2 \{ (e_1 - e_2)(e_1 - e_3) \}^{\frac{1}{2}} \{ (e_1 - e_2)^{\frac{1}{2}} + (e_1 - e_3)^{\frac{1}{2}} \}$.

[MATH. TRIP. II., 1913.]

30. Prove the formulae

$$\operatorname{sn} \alpha \operatorname{sn} \beta = \frac{\operatorname{cn} \alpha \operatorname{cn} \beta - \operatorname{cn}(\alpha + \beta)}{\operatorname{dn}(\alpha + \beta)} = \frac{\operatorname{dn} \alpha \operatorname{dn} \beta - \operatorname{dn}(\alpha + \beta)}{k^2 \operatorname{cn}(\alpha + \beta)},$$

and hence verify Cayley's theorem, that if $\alpha + \beta + \gamma + \delta = 0$, then

$$k'^2 - k^2 k'^2 \operatorname{sn} \alpha \operatorname{sn} \beta \operatorname{sn} \gamma \operatorname{sn} \delta + k^2 \operatorname{cn} \alpha \operatorname{cn} \beta \operatorname{cn} \gamma \operatorname{cn} \delta - \operatorname{dn} \alpha \operatorname{dn} \beta \operatorname{dn} \gamma \operatorname{dn} \delta = 0.$$

Prove independently that with Weierstrass' notation the addition theorem may be expressed in the form

$$(e_2 - e_3)\sigma_1 \alpha \sigma_1 \beta \sigma_1 \gamma + (e_3 - e_1)\sigma_2 \alpha \sigma_2 \beta \sigma_2 \gamma + (e_1 - e_2)\sigma_3 \alpha \sigma_3 \beta \sigma_3 \gamma = 0,$$

where $\alpha + \beta + \gamma = 0$; and show that the equivalent of Cayley's Theorem is

$$(e_2 - e_3)\sigma_1 \alpha \sigma_1 \beta \sigma_1 \gamma \sigma_1 \delta + (e_3 - e_1)\sigma_2 \alpha \sigma_2 \beta \sigma_2 \gamma \sigma_2 \delta + (e_1 - e_2)\sigma_3 \alpha \sigma_3 \beta \sigma_3 \gamma \sigma_3 \delta + (e_2 - e_3)(e_3 - e_1)(e_1 - e_2)\sigma \alpha \sigma \beta \sigma \gamma \sigma \delta = 0,$$

where $\alpha + \beta + \gamma + \delta = 0$.

[MATH. TRIP. II., 1890.]

31. Show that $\frac{\sigma(3u)}{\sigma^3(u)} = \frac{1}{4} \{ \wp'(u)\wp''(u) - \wp'^2(u) \}$

[MATH. TRIP. II., 1889.]

Show further that this result when expressed as a function of $\wp(u)$ is

$$3\wp^4(u) - \frac{3}{2}I\wp^2(u) - 3J\wp(u) - \frac{I^2}{16}.$$

32. Evaluate (i) $\int \{ \wp(u) - \wp(r) \}^2 du$; (ii) $\int \{ \wp(u) - \wp(r) \}^{-2} du$.

[MATH. TRIP. II., 1889.]

33. If one straight line cut the cubic curve $y^2 = ax^3 + bx + c$ in $(x_1, y_1), (x_2, y_2), (x_3, y_3)$, and a consecutive straight line cut the curve in $(x_1 + dx_1, y_1 + dy_1)$, etc., prove that

$$dx_1/y_1 + dx_2/y_2 + dx_3/y_3 = 0. \quad [MATH. TRIP. I., 1914.]$$

34. If a variable straight line cut the cubic $y^3 = ax^3 + bx^2 + cx + d$ at the points (x_1, y_1) , (x_2, y_2) , (x_3, y_3) , and a contiguous straight line cut the curve in $(x_1 + dx_1, y_1 + dy_1)$, etc., prove that

$$(i) \quad y_1 y_2 y_3 = ax_1 x_2 x_3 + b(x_2 x_3 + x_3 x_1 + x_1 x_2) + c(x_1 + x_2 + x_3) + d;$$

$$(ii) \quad dx_1/y_1^2 + dx_2/y_2^2 + dx_3/y_3^2 = 0. \quad [\text{GREENHILL, } E.F., \text{ p. 170.}]$$

35. Show that $[\wp(\omega_1 - u) - e_1][\wp u - e_1] = (e_1 - e_2)(e_1 - e_3)$.

36. If $u = \int_0^x (x^2 + a^2)^{-\frac{1}{2}}(x^2 + b^2)^{-\frac{1}{2}} dx$, express x as a single-valued function of u . [MATH. TRIP. II., 1919.]

37. Prove that $\frac{1}{\wp u - e_l} = \frac{\wp(u - \omega_l) - e_l}{(e_l - e_m)(e_l - e_n)}$, where l, m, n are the numbers 1, 2, 3, taken in some order. [MATH. TRIP. II., 1913.]

38. Develop a proof that if $u = \int_0^x \frac{dt}{\sqrt{(1-t^2)(1-k^2t^2)}}$, then x and $\sqrt{1-x^2}$ are single-valued functions of u . Explain clearly what conditions the path of integration must satisfy and how you fix the value of the integrand at every point of the path.

Express x as a single-valued function of u when

$$u = \int_0^x \frac{dt}{\sqrt{(1-2t)(1+t^2)}}. \quad [\text{MATH. TRIP. II., 1916.}]$$

39. If $2\omega_1$ and $2\omega_3$ be a pair of primitive periods of the elliptic functions,

$$(i) \quad \text{Show that } \frac{\wp'(u + \omega_1)}{\wp'(u)} = - \left(\frac{\wp\left(\frac{\omega_1}{2}\right) - \wp(\omega_1)}{\wp(u) - \wp(\omega_1)} \right)^2.$$

$$(ii) \quad \text{If } x = \frac{\wp\left(\frac{\omega_1}{2}\right) - \wp(\omega_1)}{\wp\left(\frac{\omega_3}{2}\right) - \wp(\omega_1)}, \text{ then}$$

$$x^2 = - \frac{\wp\left(\frac{\omega_3}{2} + \omega_1\right)}{\wp\left(\frac{\omega_3}{2}\right)} \quad \text{and} \quad x^4 = \frac{\wp(\omega_3) + 2\wp\left(\frac{\omega_3}{2} + \omega_1\right)}{\wp(\omega_3) + 2\wp\left(\frac{\omega_3}{2}\right)}.$$

Hence show how to express the coordinates of a point on the quintic $y = x(x^4 - 1)$ as elliptic functions of a single parameter.

[BURNSIDE, *Proc. L.M. Soc.*, 1892.]

40. Show that

$$E(3u) - 3E(u) = \frac{8k^2 s^3 c^3 d^3}{1 - 6k^2 s^4 + 4(k^2 + k^4)s^6 - 3k^4 s^8}.$$

[MATH. TRIP. II., 1913.]

CHAPTER XXXIII.

ELLIPTIC FUNCTIONS (*Continued*). REDUCTION TO STANDARD FORMS.

1446. Preliminary Considerations.

Taking the general integral $\int \frac{x^p dx}{\sqrt{Q}}$, where P is any rational algebraic function of x , and Q the quartic function

$$a_0x^4 + 4a_1x^3 + 6a_2x^2 + 4a_3x + a_4,$$

we now proceed to show how it may be reduced either to the Legendrian form or to the Weierstrassian form, as may be desired.

1447. We shall assume that the several coefficients occurring, viz. a_0, a_1, a_2, a_3, a_4 , are all real constants.

The roots of a biquadratic $Q=0$ with real coefficients must be either (1) all real, (2) two real, two imaginary, or (3) all imaginary.

The roots of a cubic equation with real coefficients must be either (1) all real, or (2) one real, two imaginary.

Further imaginary roots occur "in pairs," and are conjugate, i.e. of form $a \pm i\beta$, where a, β are real and $i = \sqrt{-1}$.

Hence when $a_0 \neq 0$, Q must factorise, at the least, into two real quadratic factors, and it may further factorise into two linear factors and one irreducible quadratic factor, or into four linear factors, the coefficients of such factors being all real.

And when $a_0 = 0$, Q must factorise, at the least, into one real linear factor and one irreducible quadratic factor, or it may be into three real linear factors.

For the present we shall consider $a_0 \neq 0$.

1448. **The Invariants.**

Now when any binary quartic

$$Q \equiv a_0 x^4 + 4a_1 x^3 y + 6a_2 x^2 y^2 + 4a_3 x y^3 + a_4 y^4 \equiv (a_0, a_1, a_2, a_3, a_4)(x, y)^4$$

is subjected to a linear transformation

$$x = l_1 X + m_1 Y, \quad y = l_2 X + m_2 Y,$$

so that the modulus of the transformation being

$$\Delta \equiv \begin{vmatrix} l_1 & m_1 \\ l_2 & m_2 \end{vmatrix} \equiv l_1 m_2 - l_2 m_1,$$

Q takes the form

$$\begin{aligned} Q' &\equiv a_0' X^4 + 4a_1' X^3 Y + 6a_2' X^2 Y^2 + 4a_3' X Y^3 + a_4' Y^4 \\ &\equiv (a_0', a_1', a_2', a_3', a_4')(X, Y)^4, \end{aligned}$$

the quadric invariant $I \equiv a_0 a_4 - 4a_1 a_3 + 3a_2^2$ is of order 2 and weight 4:

the cubinvariant $J \equiv a_0 a_2 a_4 + 2a_1 a_2 a_3 - a_0 a_3^2 - a_4 a_1^2 - a_2^3$ is of order 3 and weight 6:

and if I', J' be the same functions of the new coefficients in Q' , we have $I' = \Delta^4 I, J' = \Delta^6 J$, so that $I'^3 J'^2 = I^3 J^2$: and this is an absolute invariant, being independent of the letters of the transformation formulae.

Now amongst the four letters l_1, m_1, l_2, m_2 , there are three ratios at our choice, and sufficient, if they can be determined, to make either a_1' and a_3' both vanish, or a_0' and a_2' both vanish, and in either case we shall have a third choice between the three ratios still available for any other purpose of simplification which we may desire. The choice making a_1' and a_3' vanish is the Legendrian plan of attacking the problem of reduction. The choice making a_0' and a_2' vanish is the Weierstrassian method. The latter is the more modern and the simpler. We shall therefore consider it first.

1449. **REDUCTION TO THE WEIERSTRASSIAN FORM.**

If $a_0' = a_2' = 0$, the invariants become

$$I' \equiv -4a_1' a_3', \quad J' \equiv -a_1'^2 a_4',$$

$$Q' \text{ becomes } Y \left(4a_1' X^3 - \frac{I'}{a_1'} X Y^2 - \frac{J'}{a_1'^2} Y^3 \right),$$

and a_1' still remains at our disposal.

We could make it unity by a proper final choice amongst the transformation letters. For the moment we reserve the choice. In any case we have seen that it is possible to transform Q to the form

$$Q' = KY(4X^3 - g_2XY^2 - g_3Y^3),$$

where K, g_2, g_3 are certain constants which are functions of

$$a_0, a_1, a_2, a_3, a_4; \quad l_1, m_1, l_2, m_2.$$

1450. Now let

$$f(x) = a_0x^4 + 4a_1x^3 + 6a_2x^2 + 4a_3x + a_4,$$

and let the roots of $f(x)=0$ be $\alpha_0, \alpha_1, \alpha_2, \alpha_3$, so that

$$f(x) = a_0(x - \alpha_0)(x - \alpha_1)(x - \alpha_2)(x - \alpha_3).$$

From what precedes it appears that by a proper choice amongst the letters l_1, m_1, l_2, m_2 , in the homographic substitution $x = (l_1z + m_1)/(l_2z + m_2)$, $f(x)$ may be reduced to a form in which the term in z^4 is absent in the numerator.

Now
$$x - \alpha_0 = \frac{(l_1 - \alpha_0 l_2)z + (m_1 - \alpha_0 m_2)}{l_2z + m_2},$$

and if we make our first choice amongst the three disposable ratios $l_1 : m_1 : l_2 : m_2$ to be $l_1 = \alpha_0 l_2$, we shall have

$$x - \alpha_0 = \frac{m_1 - l_2 m_2}{l_2 z + m_2} = \frac{-\Delta/l_2}{l_2 z + m_2}, \quad \text{i.e. } x = \alpha_0 + \frac{\mu}{z - \eta}, \quad \text{say,}$$

and the two quantities μ, η are still at our disposal.

We now have

$$x - \alpha_1 = \alpha_0 - \alpha_1 + \frac{\mu}{z - \eta} = \frac{\alpha_0 - \alpha_1}{z - \eta} \left(z - \eta + \frac{\mu}{\alpha_0 - \alpha_1} \right),$$

$$x - \alpha_2 = \frac{\alpha_0 - \alpha_2}{z - \eta} \left(z - \eta + \frac{\mu}{\alpha_0 - \alpha_2} \right),$$

$$x - \alpha_3 = \frac{\alpha_0 - \alpha_3}{z - \eta} \left(z - \eta + \frac{\mu}{\alpha_0 - \alpha_3} \right),$$

and

$$f(x) = a_0 \mu \frac{(\alpha_0 - \alpha_1)(\alpha_0 - \alpha_2)(\alpha_0 - \alpha_3)}{(z - \eta)^4} \times \left(z - \eta + \frac{\mu}{\alpha_0 - \alpha_1} \right) \left(z - \eta + \frac{\mu}{\alpha_0 - \alpha_2} \right) \left(z - \eta + \frac{\mu}{\alpha_0 - \alpha_3} \right).$$

In order to arrange that the term in z^2 in this numerator shall be absent, we shall *make the choice of a relation between η and μ , viz. that*

$$3\eta = \mu \left(\frac{1}{a_0 - a_1} + \frac{1}{a_0 - a_2} + \frac{1}{a_0 - a_3} \right),$$

and we still have one choice left amongst the constants at our disposal.

Moreover, since $dx = -\mu dz, (z - \eta)^2$, we have

$$\frac{dx}{\sqrt{f(x)}} = \frac{-\mu dz}{\sqrt{a_0 \mu (a_0 - a_1)(a_0 - a_2)(a_0 - a_3)}} \\ \times \frac{1}{\sqrt{\left(z - \eta + \frac{\mu}{a_0 - a_1}\right) \left(z - \eta + \frac{\mu}{a_0 - a_2}\right) \left(z - \eta + \frac{\mu}{a_0 - a_3}\right)}}.$$

Let us now make our final choice amongst the disposable transformation constants, such that

$$\mu = \frac{1}{4} a_0 (a_0 - a_1)(a_0 - a_2)(a_0 - a_3).$$

Then, since $f(x) = a_0(x - a_0)(x - a_1)(x - a_2)(x - a_3)$, we have

$$\frac{1}{a_0} f'(x) = (x - a_1)(x - a_2)(x - a_3) + \text{terms containing } (x - a_0);$$

whence

$$\frac{1}{a_0} f'(a_0) = (a_0 - a_1)(a_0 - a_2)(a_0 - a_3) = \frac{1}{4} \mu; \quad \therefore \mu = \frac{1}{4} f'(a_0).$$

Again,

$$\frac{1}{2a_0} f''(x) = (x - a_0)(x - a_1) + (x - a_0)(x - a_2) + (x - a_0)(x - a_3) \\ + (x - a_1)(x - a_2) + (x - a_1)(x - a_3) \\ + (x - a_2)(x - a_3);$$

whence

$$\frac{1}{2a_0} f''(a_0) = (a_0 - a_2)(a_0 - a_3) + (a_0 - a_3)(a_0 - a_1) + (a_0 - a_1)(a_0 - a_2);$$

and since

$$\eta = \frac{1}{3} \left(\frac{\mu}{a_0 - a_1} + \frac{\mu}{a_0 - a_2} + \frac{\mu}{a_0 - a_3} \right),$$

this gives

$$\eta = \frac{1}{3} \cdot \frac{1}{4} f'(a_0) \frac{\frac{1}{2a_0} f''(a_0)}{\frac{1}{4} f'(a_0)}, \quad \text{i.e. } \eta = \frac{1}{24} f''(a_0).$$

Thus μ and η are now found, viz. $\mu = \frac{1}{4}f''(a_0)$, $\eta = \frac{1}{24}f'''(a_0)$, and $\frac{dx}{\sqrt{f(x)}} = \frac{-dz}{\sqrt{4z^3 - g_2z - g_3}}$, where g_2, g_3 remain to be expressed. And seeing that the relation $x = a_0 + \frac{\mu}{z - \eta}$ gives an infinite value to z when $x = a_0$, we have

$$\int_{a_0}^x \frac{dx}{\sqrt{f(x)}} = \int_z^\infty \frac{dz}{\sqrt{4z^3 - g_2z - g_3}} = \wp^{-1}(z, g_2, g_3);$$

and if this integral be called u , we have $z = \wp(u)$.

1451. If e_1, e_2, e_3 be the roots of $4z^3 - g_2z - g_3 = 0$, we have

$$e_1 + e_2 + e_3 = 0, \quad e_1e_2 + e_2e_3 + e_3e_1 = -\frac{g_2}{4}, \quad e_1e_2e_3 = \frac{g_3}{4}.$$

Moreover, regarding $4z^3 - g_2z - g_3$ as the form assumed by the transformed quartic function $(a_0, a_1, a_2, a_3, a_4)(x, y)^4$, viz. $0 \cdot z^4 + 4a_1z^3 + 6 \cdot 0 \cdot z^2 + 4a_3z + a_4'$, we have $a_1' = 1$, $a_3' = -\frac{1}{4}g_2$, $a_4' = -g_3$; so that $I' = g_2, J' = g_3$.

Also we have

$$\begin{aligned} e_1 - \eta &= \frac{\mu}{a_0 - a_1} = \frac{\mu}{3} \left(\frac{-2}{a_0 - a_1} + \frac{1}{a_0 - a_2} + \frac{1}{a_0 - a_3} \right) \\ &= \frac{1}{12} a_0 [-2(a_0 - a_2)(a_0 - a_3) + (a_0 - a_1)(a_0 - a_3) \\ &\quad + (a_0 - a_1)(a_0 - a_2)], \end{aligned}$$

$$i.e. \quad e_1 = \frac{a_0}{12} [(a_0 - a_2)(a_3 - a_1) - (a_0 - a_3)(a_1 - a_2)].$$

Similarly

$$e_2 = \frac{a_0}{12} [(a_0 - a_3)(a_1 - a_2) - (a_0 - a_1)(a_2 - a_3)],$$

$$e_3 = \frac{a_0}{12} [(a_0 - a_1)(a_2 - a_3) - (a_0 - a_2)(a_3 - a_1)],$$

thus expressing the roots of the cubic $4z^3 - g_2z - g_3 = 0$ in terms of the roots of the quartic $Q = 0$; and therefore g_2, g_3 or what is the same thing, I' and J' , are now known in terms of a_0, a_1, a_2, a_3 and a_0 .

We shall now for convenience drop the accents from I and J as being no longer necessary, and these letters will therefore be for the future understood to refer to the new form of the quartic function $0 \cdot z^4 + 4z^3 + 6 \cdot 0z^2 - Iz - J$, and henceforth use I and J , as in the previous chapter, instead of the letters

g_2 and g_3 respectively as may be desirable, and the accents can be restored whenever we wish to institute a comparison with the corresponding symbols belonging to the original quartic Q .

1452. Our transformation is now complete, and we have

$$u = \int_{a_0}^x \frac{dx}{\sqrt{(a_0, a_1, a_2, a_3, a_4)(x, y)^4}} = \int_z^{\infty} \frac{dz}{\sqrt{4z^3 - Iz - J}}$$

$$= \int_z^{\infty} \frac{dz}{\sqrt{4(z-e_1)(z-e_2)(z-e_3)}} = \wp^{-1}(z, I, J)$$

the transformation to effect the reduction being

$$x = a_0 + \frac{f'(a_0)}{z - a_0} + \frac{f''(a_0)}{2(z - a_0)^2}$$

1453. To find the Legendrian Moduli, the Roots of $Q=0$ being known.

The transformation formula may be written

$$z = \eta + \frac{\mu}{x - a_0}$$

we have also
$$e_1 = \eta + \frac{\mu}{a_1 - a_0}$$

and
$$z - e_1 = \frac{\mu}{x - a_0} - \frac{\mu}{a_1 - a_0} = \frac{\mu}{a_0 - a_1} \frac{x - a_1}{x - a_0}$$

i.e.
$$z - e_1 = \frac{a_0}{4} \frac{f'(a_0)}{a_0 - a_1} \frac{x - a_1}{x - a_0}$$

similarly
$$z - e_2 = \frac{a_0}{4} \frac{f'(a_0)}{a_0 - a_2} \frac{x - a_2}{x - a_0}, \quad z - e_3 = \frac{a_0}{4} \frac{f'(a_0)}{a_0 - a_3} \frac{x - a_3}{x - a_0}$$

Also the Legendrian moduli k, k' may be readily expressed in terms of a_0, a_1, a_2, a_3 . For since (Art. 1414)

$$k^2 = (e_2 - e_3)/(e_1 - e_3), \quad k'^2 = (e_1 - e_2)/(e_1 - e_3),$$

we have

$$k^2 = \frac{\frac{1}{a_0 - a_3} \frac{1}{a_0 - a_2}}{\frac{1}{a_0 - a_3} \frac{1}{a_0 - a_1}} = \frac{(a_0 - a_1)(a_3 - a_2)}{(a_0 - a_2)(a_3 - a_1)} = \{a_0, a_1, a_3, a_2\}$$

$$k'^2 = \frac{\frac{1}{a_0 - a_2} \frac{1}{a_0 - a_1}}{\frac{1}{a_0 - a_3} \frac{1}{a_0 - a_1}} = \frac{(a_0 - a_3)(a_1 - a_2)}{(a_0 - a_2)(a_1 - a_3)} = \{a_0, a_3, a_1, a_2\}$$

1454. **Cubic to find the Legendrian Moduli, available when the Roots of $Q=0$ are unknown.**

We may obtain an equation for the determination of the moduli k and k' for the case in which none of the roots of $Q=0$ are known and are not readily obtainable.

Since $k^2=(e_2-e_3)/(e_1-e_3)$ and $k'^2=1-k^2$, we have

$$\left. \begin{aligned} k^2 e_1 - e_2 + k'^2 e_3 &= 0 \\ e_1 + e_2 + e_3 &= 0; \end{aligned} \right\}$$

and

whence

$$\begin{aligned} -\frac{e_1}{(1+k'^2)} &= \frac{e_2}{k'^2-k^2} = \frac{e_3}{1+k^2} = \frac{\sqrt{e_1 e_3 - e_2^2}}{\sqrt{3(k^2 k'^2 - 1)}} \\ &= \frac{\sqrt[3]{e_1 e_2 e_3}}{\sqrt[3]{-(1+k^2)(1+k'^2)(k'^2-k^2)}}, \end{aligned}$$

and

$$e_1 e_3 - e_2^2 = -\frac{1}{4}I, \quad e_1 e_2 e_3 = \frac{1}{4}J.$$

Therefore
$$\sqrt{\frac{I}{12(1-k^2 k'^2)}} = \sqrt[3]{\frac{J}{-4(2+k^2 k'^2)(k'^2-k^2)}}.$$

Writing $k^2 k'^2 = P$,
$$\frac{I^3}{4(1-P)^3} = 27 \frac{J^2}{(2+P)^2(1-4P)} = \frac{I^3 - 27J^2}{27P^2};$$

whence

$$\frac{P^2}{(1-P)^3} = \frac{4}{27} \left(1 - 27 \frac{J^2}{I^3}\right),$$

and $\frac{J^2}{I^3}$ is an absolute invariant, free from the modulus of transformation, viz.

$$\left\{ \begin{array}{ccc} a_0, & a_1, & a_2 \\ a_1, & a_2, & a_3 \\ a_2, & a_3, & a_4 \end{array} \right\}^2 (a_0 a_4 - 4a_1 a_3 + 3a_2^2)^3$$

when expressed in terms of the coefficients of the quartic Q

This cubic for P may be solved by Cardan's method, and thus the product $k^2 k'^2$ can be found; and as $k^2 + k'^2 = 1$, both k and k' can be found.

1455. **ILLUSTRATIVE EXAMPLES.**

Ex. 1. Consider the integral $u = \int_{-1}^x \frac{dx}{\sqrt{3x^4 + 17x^3 + 9x^2 - 5x}}$.

Here there are obvious roots of $f(x)=0$, viz. $x=0$ and $x=-1$,

$$f'(x) = 12x^3 + 51x^2 + 18x - 5, \quad f''(x) = 36x^2 + 102x + 18.$$

Taking the root $x = -1$ as a_0 ,

$$f'(-1) = 16, \quad f''(-1) = -48, \quad \mu = \frac{1}{4}f'(-1) = 4, \quad \eta = \frac{1}{24}f''(-1) = -2.$$

Hence the proper reduction formula is

$$x = a_0 + \frac{\mu}{z - \eta} = -1 + \frac{4}{z+2} = -\frac{z-2}{z+2}.$$

Then $f(x) = x(x+1)(3x^2+14x-5) = x(x+1)(x+5)(3x-1)$

$$= 64(z-2)(z-1)(z+3)(z+2)^4,$$

and $dx = -4dz/(z+2)^2$;

$$\therefore \frac{dx}{\sqrt{f(x)}} = -\frac{dz}{\sqrt{4(z-2)(z-1)(z+3)}} = -\frac{dz}{\sqrt{4z^3 - 28z + 24}}.$$

Also $x = -1$ gives $z = \infty$;

$$\therefore u = \int_1^\infty \frac{dz}{\sqrt{4z^3 - 28z + 24}} = \wp^{-1}(z, 28, -24) \quad \text{and} \quad z = \wp(u).$$

In this case $e_1 = 2, e_2 = 1, e_3 = -3, k^2 = (e_3 - e_1)(e_1 - e_2) = 4/5, k'^2 = 1/5,$

$$\wp(u) = e_3 + \frac{e_1 - e_2}{\operatorname{sn}^2(u\sqrt{5})} = -3 + \frac{5}{\operatorname{sn}^2(u\sqrt{5})};$$

$$\therefore \operatorname{sn}(u\sqrt{5}) = \sqrt{5} \frac{x+1}{x+5}, \quad u = \frac{1}{\sqrt{5}} \operatorname{sn}^{-1} \sqrt{5} \frac{x+1}{x+5}.$$

Ex. 2. Take the same example, and start with the root $x = 0$.

Here $a_0 = 0, f'(0) = -5, f''(0) = 18, \mu = -5/4, \eta = 3/4,$

$$x = -5/(4z-3), \quad dx = 20 dz/(4z-3)^2,$$

$$f(x) = 1600(z-2)(z-1)(z+3)/(4z-3)^4,$$

$$\int_0^x \frac{dx}{\sqrt{f(x)}} = \int_{-\infty}^x \frac{dz}{\sqrt{4z^3 - 28z + 24}},$$

$$\begin{aligned} u = \int_{-1}^x \frac{dx}{\sqrt{f(x)}} &= \left[\int_{-1}^0 + \int_0^x \right] \frac{dx}{\sqrt{f(x)}} = \left(\int_2^{-\infty} + \int_{-\infty}^x \right) \frac{dz}{\sqrt{4z^3 - 28z + 24}} \\ &= \int_2^x \frac{dz}{\sqrt{4z^3 - 28z + 24}} = \left(\int_2^\infty - \int_x^\infty \right) \frac{dz}{\sqrt{4z^3 - 28z + 24}} \\ &= 2\omega_1 - \int_x^\infty \frac{dz}{\sqrt{4z^3 - 28z + 24}}. \end{aligned}$$

Hence $z = \wp(2\omega_1 - u) = \wp(u)$, as before.

Ex. 3. Examine the same integral with the substitution $x = 5 \frac{s^2 - 1}{5 - s^2}$.

$$\text{Then } dx = \frac{40s ds}{(5-s^2)^2}, \quad x+1 = \frac{4s^2}{5-s^2}, \quad x+5 = \frac{20}{5-s^2}, \quad 3x-1 = 4 \frac{4s^2-5}{5-s^2}.$$

$$\text{Hence } u = \frac{1}{\sqrt{5}} \int_0^s \frac{ds}{\sqrt{(1-s^2)(1-\frac{4}{5}s^2)}}; \quad \therefore s = \operatorname{sn}(u\sqrt{5}); \quad \operatorname{mod.} \frac{2}{\sqrt{5}},$$

which agrees with the former result (Ex. 1), in which

$$\wp(u) = -3 + \frac{5}{s^2} \quad \text{and} \quad x = -1 + \frac{4}{\wp(u)+2} = -1 + \frac{4s^2}{5-s^2} = 5 \frac{s^2-1}{5-s^2}.$$

1456. Transformation for the Case of Unreal Values of the e 's.

So far e_1, e_2, e_3 have been considered real. Now suppose e_1 real and e_2, e_3 to be complementary imaginaries. Take the hyperbolic transformation $y - \eta_1 = \frac{(x - e_2)(x - e_3)}{x - e_1}$, where η_1 is at our choice. Since $e_1 + e_2 + e_3 = 0$, we have

$$y - \eta_1 = \frac{x^2 + e_1x + e_2e_3}{x - e_1} = x + 2e_1 + \frac{e_2e_3 + 2e_1^2}{x - e_1}.$$

Let us choose $\eta_1 = -2e_1$, i.e. choose the hyperbola so that the oblique asymptote passes through the origin. Then the graph of this transformation is a hyperbola with asymptotes $x = e_1$, $y = x$ and centre (e_1, e_1) . Let (ξ_2, η_2) , (ξ_3, η_3) be the points at which the tangent is parallel to the x -axis. These points are the ends of a diameter, and $\eta_2 + \eta_3 = 2e_1 = -\eta_1$; $\therefore \eta_1 + \eta_2 + \eta_3 = 0$. Moreover, ξ_1 and ξ_2 , which are the roots of $\frac{dy}{dx} = 0$, must be repeated roots of the equations $y = \eta_2$ and $y = \eta_3$ respectively, i.e.

$$y - \eta_2 = \frac{(x - \xi_2)^2}{x - e_1} \quad \text{and} \quad y - \eta_3 = \frac{(x - \xi_3)^2}{x - e_1},$$

whilst $\frac{dy}{dx}$, which is $1 - \frac{e_2e_3 + 2e_1^2}{(x - e_1)^2}$, must take the form

$$\frac{dy}{dx} = \frac{(x - \xi_2)(x - \xi_3)}{(x - e_1)^2}.$$

Clearly the values of ξ_2, ξ_3 are $e_1 \pm \sqrt{e_2e_3 + 2e_1^2}$.

$$\begin{aligned} \text{Thus } \int \frac{dx}{\sqrt{4(x - e_1)(x - e_2)(x - e_3)}} \\ &= \int \frac{dy (x - e_1)^2}{(x - \xi_2)(x - \xi_3)} \cdot \frac{1}{\sqrt{4(x - e_1)(x - e_2)(x - e_3)}} \\ &= \int \frac{(x - e_1)^2 dy}{\sqrt{(x - e_1)(y - \eta_2)} \sqrt{(x - e_1)(y - \eta_3)} \sqrt{4(x - e_1)^2(y - \eta_1)}} \\ &= \int \frac{dy}{\sqrt{4(y - \eta_1)(y - \eta_2)(y - \eta_3)}}, \end{aligned}$$

in which $\eta_1 + \eta_2 + \eta_3 = 0$.

The nature of the transformation graph, in which the branches of the hyperbola cannot cut the line $y = \eta_1$, since e_2 and e_3 are imaginary, and which must therefore lie in the com-

partments between the asymptotes as shown in Fig. 427, establishes the fact that η_1, η_2, η_3 are essentially real quantities; $y = \eta_3$ and $y = \eta_2$ are the maximum and minimum ordinates of

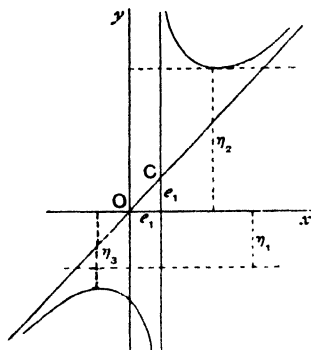

Fig. 427.

the graph, and the line $y = \eta_1 - 2e_1$ is a line parallel to the x -axis at a distance twice as far below that axis as the centre is above it.

1457. Analytical Examination of the same Transformation.

If the roots of any cubic $a_0x^3 + 3a_1x^2 + 3a_2x + a_3 = 0$ be a_1, a_2, a_3 , we have $a_0^4(a_2 - a_3)^2(a_3 - a_1)^2(a_1 - a_2)^2 = -27a_0^2\Delta$, where Δ is the discriminant, viz.

$$\Delta \equiv a_0^2a_3^2 - 6a_0a_1a_2a_3 + 4a_0^3a_2^3 + 4a_1^3a_3 - 3a_1^2a_2^2,$$

(Bunside and Panton, *Th. of Eq.*, p. 83.)

and the roots are all real or one real and two imaginary, according as Δ is $-$ or $+$.

In the case of the cubic $4x^3 - Ix - J = 0$, with roots e_1, e_2, e_3 , we have $a_0 = 4, a_1 = 0, a_2 = -\frac{1}{3}I, a_3 = -J$; $\Delta = 4^2J^2 + 4 \cdot 4(-\frac{1}{3}I)^3 = -\frac{1}{27}(I^3 - 27J^2)$, and

$$(e_2 - e_3)^2(e_3 - e_1)^2(e_1 - e_2)^2 = \frac{1}{18}(I^3 - 27J^2).$$

The roots are then all real or one real and two imaginary, according as $I^3 - 27J^2$ is $+$ or $-$. In the case we are considering, viz. one real, say e_1 , and two imaginary, viz. $e_2 = p + iq, e_3 = p - iq, p$ and q being real, and $e_1 = -2p$, so that $e_1 + e_2 + e_3 = 0$, we have

$$I^3 - 27J^2 = 16(2iq)^2(9p^2 + q^2)^2 = -64q^2(9p^2 + q^2)^2 = -.$$

But when we transform by the equation $y = x + \frac{R^2}{x - e_1}$, where

$$R^2 = e_2e_3 + 2e_1^2 = 5p^2 + q^2 = +,$$

we have $\xi_2 = e_1 + R, \xi_3 = e_1 - R, \eta_2 = e_1 + 2R, \eta_3 = e_1 - 2R, \eta_1 = -2e_1$; and in the new cubic, $4y^3 - I'y - J' = 0$, we have

$$\begin{aligned} I'^3 - 27J'^2 &= 16(\eta_2 - \eta_3)^2(\eta_3 - \eta_1)^2(\eta_1 - \eta_2)^2 = 16(4R)^2(3e_1 - 2R)^2(-3e_1 - 2R)^2 \\ &= 256R^2(9e_1^2 - 4R^2)^2 = 256(5p^2 + q^2)(16p^2 - 4q^2)^2 = +. \end{aligned}$$

Hence all the roots of the new cubic are real.

1458. ILLUSTRATIVE EXAMPLE.

Integrate
$$u \equiv \int_x^1 \frac{dx}{\sqrt{x^4 - 12x^3 + 54x^2 - 100x + 57}}.$$

Here $x=1$ is an obvious root of $f(x)=0$,

$$\left. \begin{aligned} f'(x) &= 4x^3 - 36x^2 + 108x - 100, & f'(1) &= -24, \\ f''(x) &= 12x^2 - 72x + 108, & f''(1) &= 48; \end{aligned} \right\}$$

$$\therefore \mu = \frac{1}{4}f'(1) = -6, \quad \eta = \frac{1}{2}f''(1) = 2.$$

The transformation formula is $x = a_0 + \frac{\mu}{z - \eta} = 1 - \frac{6}{z - 2}$.

We also have

$$f(x) = (x-1)(x^3 - 11x^2 + 43x - 57) = (x-1)(x-3)[(x-4)^2 + 3];$$

hence two roots for x , and therefore also for z , in the transformed equation will be imaginary.

The transformation is

$$-\frac{6}{(z-2)^4}(-2)(z+1)(12)(z^2-z+1) = \frac{144}{(z-2)^4}(z^2+1);$$

also $dx = \frac{6dz}{(z-2)^2}$; whence $\int_x^1 \frac{dx}{\sqrt{f(x)}} = \int_z^\infty \frac{dz}{\sqrt{4z^3+4}} = \wp^{-1}(z, 0, -4)$.

Transform further by the rule of Art. 1456.

$$e_1 = -1, \quad \eta_1 = -2e_1 = 2, \quad y = \eta_1 + \frac{z^2 - z + 1}{z + 1} = \frac{z^2 + z + 3}{z + 1} = z + \frac{3}{z + 1},$$

and $\frac{dy}{dz} = 1 - \frac{3}{(z+1)^2} = 0$ gives $z = \pm\sqrt{3} - 1$.

Therefore $\eta_2 = 2\sqrt{3} - 1$, $\eta_3 = -2\sqrt{3} - 1$ and $\eta_1 + \eta_2 + \eta_3 = 0$,

$$y - \eta_2 = \frac{(z - \sqrt{3} + 1)^2}{z + 1}, \quad y - \eta_3 = \frac{(z + \sqrt{3} + 1)^2}{z + 1};$$

$$\begin{aligned} \therefore u &\equiv \int_x^1 \frac{dx}{\sqrt{4z^3+4}} = \int_y^\infty \frac{dy}{(z+1)^2-3} \cdot \frac{(z+1)^2}{\sqrt{4(z+1)^2(y-\eta_1)}} \\ &= \int_y^\infty \frac{dy}{\sqrt{(z+1)(y-\eta_2)}\sqrt{(z+1)(y-\eta_3)}} \cdot \frac{z+1}{\sqrt{4(y-\eta_1)}} \\ &= \int_y^\infty \frac{dy}{\sqrt{4(y-\eta_1)(y-\eta_2)(y-\eta_3)}} = \int_y^\infty \frac{dy}{\sqrt{4(y-2)(y^2+2y-11)}} \\ &= \int_{y1}^\infty \frac{dy}{\sqrt{4(y^3-15y+22)}} = \wp^{-1}(y, 60, -88). \end{aligned}$$

In order of magnitude the values of the η 's are

$$\eta_2 = 2\sqrt{3} - 1, \quad \eta_1 = 2, \quad \eta_3 = -2\sqrt{3} - 1;$$

whence
$$k^2 = \frac{3+2\sqrt{3}}{4\sqrt{3}} = \frac{4+2\sqrt{3}}{8} = \sin^2 75^\circ.$$

Thus $y = \wp(u) = 2 + 4\sqrt{3} \frac{\operatorname{dn}^2 2\sqrt{3}u}{\operatorname{sn}^2 2\sqrt{3}u}$, mod. $\sin 75^\circ$; whence we can express z and x in terms of u .

We have
$$\operatorname{cn}^2 2\sqrt{3}u = \frac{\wp(u) - 2\sqrt{3} + 1}{\wp(u) + 2\sqrt{3} + 1},$$

and
$$u = \frac{1}{2\sqrt{3}} \operatorname{cn}^{-1} \sqrt{\frac{y+1-2\sqrt{3}}{y+1+2\sqrt{3}}}$$

$$= \frac{1}{2\sqrt{3}} \operatorname{cn}^{-1} \sqrt{\frac{2(7-5x+x^2) - \sqrt{3}(1-x)(3-x)}{2(7-5x+x^2) + \sqrt{3}(1-x)(3-x)}}, \pmod{\sin 75^\circ}.$$

1459. REDUCTION TO THE LEGENDRIAN FORM.

We next turn to the other method of reduction referred to in Art. 1448, which endeavours to express $\int \frac{dx}{\sqrt{Q}}$ directly in the Legendrian form $\int \frac{dx}{\sqrt{(1-x^2)(1-k^2x^2)}}$, ($k^2 < 1$).

1460. Preliminary Geometrical Considerations.

It will be convenient to consider the expression Q made homogeneous by the introduction of the proper power of y where necessary, and written with binomial coefficients, as

$$Q \equiv a_0x^4 + 4a_1x^3y + 6a_2x^2y^2 + 4a_3xy^3 + a_4y^4,$$

and to imagine it to have been factorised into two quadratic factors with real coefficients, as

$$Q \equiv (ax^2 + 2hxy + by^2)(a'x^2 + 2h'xy + b'y^2).$$

Consider the two concentric conics whose equations are

$$ax^2 + 2hxy + by^2 = F, \quad a'x^2 + 2h'xy + b'y^2 = G;$$

F and G being at our choice, we may select them so as to give real intersections P, Q, R, S , which will always be possible if one of the conics be an ellipse. Then it is plain that $PQRS$ is a parallelogram concentric with the conics, and that as PQ, QR form a pair of supplemental chords of both conics, the lines through the centre drawn parallel to the sides of the parallelogram form a common pair of conjugate diameters, viz. OX, OY . It is therefore possible by a change of axes, to the axes OX, OY , to remove the term in XY in each of the two conics simultaneously by the same linear transformation, viz. $(x = \lambda X + \mu Y, y = \lambda' X + \mu' Y)$, say; $\lambda, \mu, \lambda', \mu'$ being all *real* when one of the two conics is an ellipse, or when both of them are ellipses; and the conics becoming

$$AX^2 + BY^2 = F, \quad A'X^2 + B'Y^2 = G,$$

Q can thus be reduced to the form

$$Q' \equiv (AX^2 + BY^2)(A'X^2 + B'Y^2),$$

or, as we may write it,

$$Q' \equiv A_0X^4 + 6A_2X^2Y^2 + A_4Y^4.$$

We may obviously make a further reduction by putting $X\sqrt{A_0} = \xi$, $Y\sqrt{A_4} = \eta$, thus reducing the quartic Q to the canonical form

$$Q \equiv \xi^4 + 6\lambda\xi^2\eta^2 + \eta^4.$$

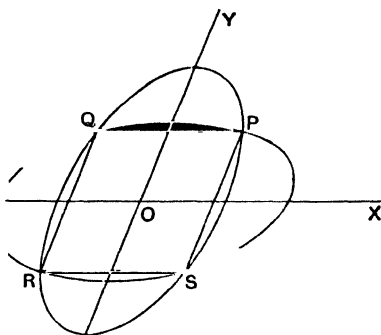

Fig. 428.

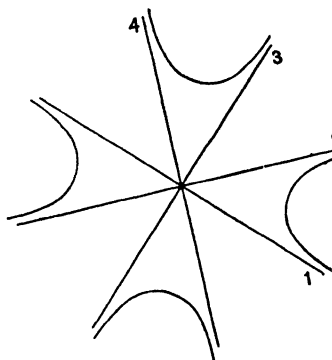

Fig. 429.

If both conics be hyperbolae, the common conjugate diameters may be imaginary lines. But in any case their equations are

$$\begin{vmatrix} x^2 & xy & y^2 \\ b & -h & a \\ b' & -h' & a' \end{vmatrix} = 0.$$

(Smith, *Conic Sections*, p. 196.)

We may, however, readily avoid an imaginary transformation. For, as has been seen, the only case in which it could occur would be that in which both conics are hyperbolae, as in the case shown in Fig. 429, where there are no real intersections. In this case the factors of Q are all linear. Call them (1), (2), (3), (4). Then, instead of taking the hyperbolae (1)(2) = F , (3)(4) = G , we might take the hyperbolae (1)(4) = F , (2)(3) = G (Fig. 430), and with a proper choice of F and G we can ensure real intersections and real common conjugate axes

to which we can refer the system. We infer therefore from these considerations that it is always possible to remove from

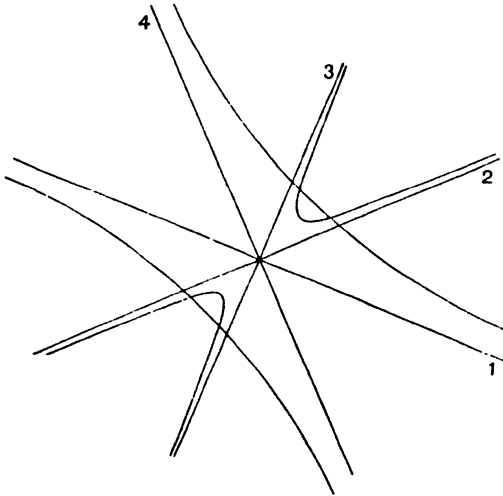

Fig. 430.

Q the terms containing x^3y and xy^3 simultaneously by a *real* linear transformation.

1461. If in the transformation formulae

$$x = \lambda X + \mu Y, \quad y = \lambda' X + \mu' Y,$$

we write $\lambda' X = \xi$, $\mu' Y = \eta$, the formulae take the simpler shape $x = \lambda_1 \xi + \mu_1 \eta$, $y = \xi + \eta$. It follows, therefore, that it is always possible, by a *real* substitution $x = (p + qz)/(1 + z)$, to reduce Q from the general quartic form

$$Q \equiv a_0 x^4 + 4a_1 x^3 + 6a_2 x^2 + 4a_3 x + a_4,$$

to the form $Q \equiv (A_1 z^2 + B_1)(A_2 z^2 + B_2)/(1 + z)^4$;

and since $dx = (q - p) dz/(1 + z)^2$, we have

$$\frac{dx}{\sqrt{Q}} = (q - p) \frac{dz}{\sqrt{(A_1 z^2 + B_1)(A_2 z^2 + B_2)}}$$

and the values of p , q are in all cases real.

1462. **Outline of the Process of Transformation.**

As the whole discussion is necessarily somewhat lengthy, we may with advantage stop for a moment to outline what is to be done.

I. It has been shown that when $a_0 \neq 0$, we can always, by the transformation $x=(p+qz)/(1+z)$, remove odd powers of the variable from the radical, p and q being real.

It remains to show how the necessary values of p and q are to be found.

II. We shall show that the same transformation will also reduce the integral to the desired form in the case when $a_0=0$.

III. That by a further transformation

$$z^2 = (A + Bs^2)/(C + Ds^2),$$

or, which is the same thing, $z^2 = (A + B \sin^2 \theta)/(C + D \sin^2 \theta)$, the form now arrived at can be still further reduced so that

$\int \frac{dx}{\sqrt{Q}}$ becomes a constant multiple of

$$\int \frac{ds}{\sqrt{(1-s^2)(1-k^2s^2)}} \quad \text{or} \quad \int \frac{d\theta}{\sqrt{1-k^2 \sin^2 \theta}}, \quad (k < 1).$$

The ratios $A : B : C : D$ are at our choice.

IV That starting with the integral $\int \frac{M}{N} \frac{dx}{\sqrt{Q}}$, where M, N are rational integral algebraic functions of x , we obtain after the transformation $x=(p+qz)/(1+z)$ a result of form

$$\int \frac{[\phi(z^2) + z\psi(z^2)] dz}{\sqrt{(A_1z^2 + B_1)(A_2z^2 + B_2)}},$$

and that whilst $\int \frac{z\psi(z^2) dz}{\sqrt{(A_1z^2 + B_1)(A_2z^2 + B_2)}}$ can be reduced by

earlier rules, the portion $\int \frac{\phi(z^2) dz}{\sqrt{(A_1z^2 + B_1)(A_2z^2 + B_2)}}$ can be

expressed by means of Legendre's Integrals, and that therefore by these means $\int \frac{M dx}{N \sqrt{Q}}$ can in all cases be reduced to a system of algebraic, logarithmic, circular or hyperbolic functions together with one or more of the three standard Legendrian forms F, E or Π .

Hence, as in Art. 318, the integral $\int \frac{A + B\sqrt{Q}}{C + D\sqrt{Q}} dx$, where A, B, C, D are rational algebraic functions of x , and Q is now

a rational quartic expression, can be reduced to the sum of a similar set of terms by aid of the elliptic functions now described.

1463. I. First consider $a_0 \neq 0$ and imagine Q to be factorised into two quadratic factors with real coefficients, as

$$Q = a_0(x^2 + 2\lambda x + \mu)(x^2 + 2\lambda'x + \mu').$$

Then putting $x = (p + qz)/(1 + z)$,

$$\begin{aligned} x^2 + 2\lambda x + \mu &= [(p + qz)^2 + 2\lambda(p + qz)(1 + z) + \mu(1 + z)^2]/(1 + z)^2 \\ &= H(z^2 + 2fz + g)/(1 + z)^2, \text{ where } H \equiv q^2 + 2\lambda q + \mu, \end{aligned}$$

and
$$\frac{1}{H} = \frac{f}{pq + \lambda(p + q) + \mu} = \frac{g}{p^2 + 2\lambda p + \mu}.$$

Similarly, $x^2 + 2\lambda'x + \mu' = H'(z^2 + 2f'z + g')/(1 + z)^2,$

where H', f', g' are the same functions of p, q, λ', μ' , as H, f, g are of p, q, λ, μ .

Hence $Q \equiv a_0 H H' (z^2 + 2fz + g)(z^2 + 2f'z + g')/(1 + z)^4.$

We shall be able to make f and f' zero by taking p and q so that

$$pq + \lambda(p + q) + \mu = 0 \quad \text{and} \quad pq + \lambda'(p + q) + \mu' = 0,$$

i.e.
$$\frac{pq}{\lambda\mu' - \lambda'\mu} = \frac{p + q}{\mu - \mu'} = \frac{1}{\lambda' - \lambda} = \frac{p - q}{\sqrt{(\mu - \mu')^2 - 4(\lambda' - \lambda)(\lambda\mu' - \lambda'\mu)}}.$$

Now $(\mu - \mu')^2 - 4(\lambda' - \lambda)(\lambda\mu' - \lambda'\mu)$
 $\equiv (\mu + \mu' - 2\lambda\lambda')^2 - 4(\mu - \lambda^2)(\mu' - \lambda'^2) = K^2$, say.

So $p + q = (\mu - \mu')/(\lambda' - \lambda)$ and $p - q = K/(\lambda' - \lambda)$, whence p and q are found.

This completely determines the necessary transformation, and we shall show that K is real; so that in all cases p and q are real.

The form of Q is now reduced to

$$Q \equiv a_0 H H' (z^2 + g)(z^2 + g')/(1 + z)^4.$$

Also $dz = (q - p)dz/(1 + z)^2.$

Therefore
$$\frac{dx}{\sqrt{Q}} = \frac{q - p}{\sqrt{a_0 H H'}} \cdot \frac{dz}{\sqrt{(z^2 + g)(z^2 + g')}}.$$

1464. **Next, to examine the Reality of K .**

(i) When the roots of $Q=0$ are all imaginary, $\lambda^2 < \mu$ and $\lambda'^2 < \mu'$.

Let $\mu = \lambda^2 + \rho^2$, $\mu' = \lambda'^2 + \rho'^2$. Then

$$\begin{aligned} K^2 &= (\mu + \mu' - 2\lambda\lambda')^2 - 4(\mu - \lambda^2)(\mu' - \lambda'^2) \\ &= (\lambda^2 + \rho^2 + \lambda'^2 + \rho'^2 - 2\lambda\lambda')^2 - 4\rho^2\rho'^2 \\ &= [(\lambda - \lambda')^2 + (\rho - \rho')^2] \cdot [(\lambda - \lambda')^2 + (\rho + \rho')^2] \end{aligned}$$

and is essentially positive. Hence K is real and p, q both real.

(ii) When $Q=0$ has two real roots and two imaginary, $\lambda^2 - \mu$ and $\lambda'^2 - \mu'$ have opposite signs, and

$$\begin{aligned} K^2 &= (\mu + \mu' - 2\lambda\lambda')^2 - 4(\mu - \lambda^2)(\mu' - \lambda'^2) \\ &= (\mu + \mu' - 2\lambda\lambda')^2 + \text{a positive quantity} = +ve. \end{aligned}$$

Hence K is real, and therefore also p, q are both real.

(iii) When the roots of $Q=0$ are all real, say a_1, a_2, a_3, a_4 arranged in descending order of magnitude, we may take

$$\begin{aligned} 2\lambda &= -(a_1 + a_2), \quad \mu = a_1a_2, \quad 2\lambda' = -(a_3 + a_4), \quad \mu' = a_3a_4; \\ \therefore K^2 &= (\mu + \mu' - 2\lambda\lambda')^2 - 4(\mu - \lambda^2)(\mu' - \lambda'^2) \\ &= [a_1a_2 + a_3a_4 - \frac{1}{2}(a_1 + a_2)(a_3 + a_4)]^2 \\ &\quad - \frac{1}{4}[4a_1a_2 - (a_1 + a_2)^2] \cdot [4a_3a_4 - (a_3 + a_4)^2] \\ &= (a_1 - a_4)(a_2 - a_3)(a_1 - a_3)(a_2 - a_4), \end{aligned}$$

which is again positive, and therefore K, p, q are all real.

In the case $f=f'$, we may put $z+f=u$.

Then $Q \equiv a_0 HH'(u^2 + g - f^2)(u^2 + g' - f'^2)$, and the required form is taken without further reduction.

1465. II. **Case when $a_0=0$.**

In this case $Q \equiv 4a_1x^3 + 6a_2x^2 + 4a_3x + a_4$.

The case $a_1=0$ need not be considered, as the integral would then reduce to a standard form.

One factor of Q must now be real. Let ϵ be the real root of $Q=0$.

Then $Q \equiv 4a_1(x - \epsilon)(x^2 + 2\lambda x + \mu)$, say. Then, putting

$$x = (p + qz)/(1 + z), \text{ as before,}$$

$$x - \epsilon = [(p - \epsilon) + (q - \epsilon)z]/(1 + z) = H'(z^2 + 2f'z + g')/(1 + z)^2$$

say, and $x^2 + 2\lambda x + \mu = H(z^2 + 2fz + g)/(1+z)^2$, as before. Then proceeding as in Art. 1463,

$$H' = q - \epsilon, \quad 2Hf' = p + q - 2\epsilon, \quad H'g' = p - \epsilon;$$

and making $f = f' = 0$, $p + q = 2\epsilon$ and $p q + \lambda(p + q) + \mu = 0$

Therefore $p + q = 2\epsilon$, $p q = -2\epsilon\lambda - \mu$, whence

$$p - q = 2\sqrt{(\epsilon + \lambda)^2 + \mu - \lambda^2}.$$

Thus, (i) if the factors of $x^2 + 2\lambda x + \mu$ be imaginary, $\lambda^2 < \mu$, $p - q$ is real, and therefore p, q are both real :

(ii) if the factors of $x^2 + 2\lambda x + \mu$ be real, let the roots of $Q = 0$ be e_1, e_2, e_3 , arranged in descending order of magnitude.

Then we may take $\epsilon = e_1$, $\lambda = -\frac{e_2 + e_3}{2}$, $\mu = e_2 e_3$, and

$$p - q = 2\sqrt{\{e_1 - \frac{1}{2}(e_2 + e_3)\}^2 + e_2 e_3 - \frac{1}{4}(e_2 + e_3)^2} = 2\sqrt{(e_1 - e_2)(e_1 - e_3)},$$

which is real, since $e_1 > e_2 > e_3$; and p, q are real in this case also. And the rest of Art. 1463 still applies, and the reduction to the Legendrian form is effected as before, Q becoming

$$4a_1 H H' (z^2 + g)(z^2 + g')(1+z)^4$$

and

$$\frac{dx}{\sqrt{Q}} = \frac{q - p}{\sqrt{4a_1 H H'}} \frac{dz}{\sqrt{(z^2 + g)(z^2 + g')}}.$$

1466. We have therefore in all cases reduced the differential $\frac{dx}{\sqrt{Q}}$ to one of the forms $C \frac{dz}{\sqrt{\pm(z^2 \pm a^2)(z^2 \pm \beta^2)}}$, where C may be taken a real constant function of a_0, a_1, a_2, a_3, a_4 of known value and a, β both real. For if $\sqrt{a_0 H H'}$ or $\sqrt{4a_1 H H'}$ be of unreal form, we may replace them by $\sqrt{-a_0 H H'}$ or $\sqrt{-4a_1 H H'}$ carrying the negative sign into the other radical.

The case $\sqrt{(z^2 + a^2)(z^2 + \beta^2)}$ is obviously unreal and need not be discussed, as we are now dealing with real functions.

1467. III. We have therefore only to consider the reduction of the five cases :

- (1) $\sqrt{+(z^2 - a^2)(z^2 - \beta^2)}$; (2) $\sqrt{-(z^2 - a^2)(z^2 - \beta^2)}$;
- (3) $\sqrt{+(z^2 + a^2)(z^2 - \beta^2)}$; (4) $\sqrt{-(z^2 + a^2)(z^2 - \beta^2)}$;
- (5) $\sqrt{+(z^2 + a^2)(z^2 + \beta^2)}$.

The final substitutions to reduce these five cases are all of the form $z^2 = (A + B \sin^2 \theta) / (C + D \sin^2 \theta)$, where the values of the ratios $A : B : C : D$ are to be suitably chosen. We consider each case in detail.

1468. Case (1), $\sqrt{(z^2 - a^2)(z^2 - \beta^2)}$; $a^2 > \beta^2$. This is unreal if z^2 lies between a^2 and β^2 .

(i) $a > \beta > z$. Put $z = \beta \sin \theta$, $k = \beta/a$.

$$u = \int_0^z \frac{dz}{\sqrt{(z^2 - a^2)(z^2 - \beta^2)}} = \frac{1}{\beta} \int_0^\theta \frac{\beta \cos \theta d\theta}{\sqrt{(a^2 - \beta^2 \sin^2 \theta) \cos^2 \theta}} \\ = \frac{1}{a} \int_0^\theta \frac{d\theta}{\sqrt{1 - k^2 \sin^2 \theta}} = \frac{1}{a} \operatorname{am}^{-1} \theta.$$

Hence $z = \beta \operatorname{sn} au$; mod. β/a .

(ii) $z > a > \beta$. Put $z = a \operatorname{cosec} \theta$, $k = \beta/a$.

$$u = \int_z^\infty \frac{dz}{\sqrt{(z^2 - a^2)(z^2 - \beta^2)}} = \frac{1}{a} \int_0^\theta \frac{-a \operatorname{cosec} \theta \cot \theta d\theta}{\sqrt{\cot^2 \theta (a^2 \operatorname{cosec}^2 \theta - \beta^2)}} \\ = \frac{1}{a} \int_0^\theta \frac{d\theta}{\sqrt{1 - k^2 \sin^2 \theta}} = \frac{1}{a} \operatorname{am}^{-1} \theta.$$

Hence $z = a \operatorname{sn} au$; mod. β/a .

$$\text{Also } u' = \int_a^z \frac{dz}{\sqrt{(z^2 - a^2)(z^2 - \beta^2)}} = -\frac{1}{a} \int_{\frac{\pi}{2}}^\theta \frac{d\theta}{\sqrt{1 - k^2 \sin^2 \theta}} \\ = \frac{1}{a} \left(\int_0^{\frac{\pi}{2}} - \int_0^\theta \right) \frac{d\theta}{\sqrt{1 - k^2 \sin^2 \theta}} = \frac{1}{a} (K - \operatorname{am}^{-1} \theta),$$

where K is the complete elliptic integral.

Hence $z = a \operatorname{sn}(K - au') = a \operatorname{dn}(au') / \operatorname{cn}(au')$.

1469. Case (2), $\sqrt{-(z^2 - a^2)(z^2 - \beta^2)}$; $a^2 > \beta^2$. This is unreal if z^2 does not lie between a^2 and β^2 .

Put $z^2 = a^2 - (a^2 - \beta^2) \sin^2 \theta$, i.e. $a^2 \cos^2 \theta + \beta^2 \sin^2 \theta$.

Then $a^2 - z^2 = (a^2 - \beta^2) \sin^2 \theta$, $z^2 - \beta^2 = (a^2 - \beta^2) \cos^2 \theta$,

$$dz = -(a^2 - \beta^2) \frac{\sin \theta \cos \theta d\theta}{\sqrt{a^2 - (a^2 - \beta^2) \sin^2 \theta}}, \\ u = \int_z^a \frac{dz}{\sqrt{-(z^2 - a^2)(z^2 - \beta^2)}} = \frac{1}{a} \int_0^\theta \frac{d\theta}{\sqrt{1 - k^2 \sin^2 \theta}} = \frac{1}{a} \operatorname{am}^{-1} \theta,$$

where $k^2 = \frac{a^2 - \beta^2}{a^2}$, $k'^2 = \frac{\beta^2}{a^2}$.

Hence

$$z^2 = a^2 \operatorname{cn}^2(au) + \beta^2 \operatorname{sn}^2(au), \quad \text{i.e. } z = a \operatorname{dn}(au), \quad \text{mod. } \sqrt{1 - \frac{\beta^2}{a^2}}.$$

1470. Case (3), $\sqrt{(z^2 + a^2)(z^2 - \beta^2)}$. This is unreal unless $z^2 > \beta^2$. Put $z = \beta \sec \theta$.

$$\begin{aligned} u &= \int_{\beta}^z \frac{dz}{\sqrt{(z^2 + a^2)(z^2 - \beta^2)}} = \int_0^{\theta} \frac{\beta \sec \theta \tan \theta d\theta}{\sqrt{\beta^2 \tan^2 \theta (\beta^2 \sec^2 \theta + a^2)}} \\ &= \int_0^{\theta} \frac{d\theta}{\sqrt{\beta^2 + a^2 \cos^2 \theta}} = \frac{1}{\sqrt{a^2 + \beta^2}} \int_0^{\theta} \frac{d\theta}{\sqrt{1 - k^2 \sin^2 \theta}}, \quad \left(k^2 = \frac{a^2}{a^2 + \beta^2}\right), \\ &= \frac{k}{a} \int_0^{\theta} \frac{d\theta}{\sqrt{1 - k^2 \sin^2 \theta}} = \frac{k}{a} \operatorname{am}^{-1} \theta. \end{aligned}$$

$$\text{Hence } z = \beta \operatorname{cn} \left(\frac{au}{k} \right).$$

1471. Case (4), $\sqrt{-(z^2 + a^2)(z^2 - \beta^2)}$. This is unreal unless $z^2 < \beta^2$. Put $z = \beta \cos \theta$.

$$\begin{aligned} u &= \int_z^{\beta} \frac{dz}{\sqrt{-(z^2 + a^2)(z^2 - \beta^2)}} = \int_{\theta}^0 \frac{-\beta \sin \theta d\theta}{\sqrt{\beta^2 \sin^2 \theta (a^2 + \beta^2 \cos^2 \theta)}} \\ &= \frac{1}{\sqrt{a^2 + \beta^2}} \int_0^{\theta} \frac{d\theta}{\sqrt{1 - k^2 \sin^2 \theta}} = \frac{k}{\beta} \operatorname{am}^{-1} \theta, \quad \left(k^2 = \frac{\beta^2}{a^2 + \beta^2}\right). \end{aligned}$$

$$\text{Hence } z = \beta \operatorname{cn} \left(\frac{\beta u}{k} \right), \quad \text{mod. } \frac{\beta}{\sqrt{a^2 + \beta^2}}.$$

1472. Case (5), $\sqrt{(z^2 + a^2)(z^2 + \beta^2)}$; $a^2 > \beta^2$. Put $z = \beta \tan \theta$.

$$\begin{aligned} u &= \int_0^z \frac{dz}{\sqrt{(z^2 + a^2)(z^2 + \beta^2)}} = \int_0^{\theta} \frac{d\theta}{\sqrt{\beta^2 \sin^2 \theta + a^2 \cos^2 \theta}} \\ &= \frac{1}{a} \int_0^{\theta} \frac{d\theta}{\sqrt{1 - k^2 \sin^2 \theta}} = \frac{1}{a} \operatorname{am}^{-1} \theta, \quad \left(k^2 = \frac{a^2 - \beta^2}{a^2}\right). \end{aligned}$$

$$\text{Hence } z = \beta \operatorname{tn}(au) \left(\text{mod. } \sqrt{1 - \frac{\beta^2}{a^2}} \right).$$

For convenience of reference we exhibit these cases in tabular form :

1473. TABLE OF SUBSTITUTIONS, ETC.

Case.	\sqrt{Q} .	Limitation of z .	Substitution.	Mod. k .	Value of $u \equiv \int \frac{dz}{\sqrt{Q}}$.	Direct Form.
1	$\sqrt{(z^2 - \alpha^2)(z^2 - \beta^2)}$ $\alpha^2 > \beta^2$	$\alpha > \beta > z$ $z > \alpha > \beta$	$z = \beta r$ $= \beta \sin \theta$ $z = \alpha / r$ $= \alpha / \sin \theta$	$\frac{\beta}{\alpha}$ $\frac{\beta}{\alpha}$	$u = \int_0^z \frac{dz}{\sqrt{Q}} = \frac{1}{\alpha} \operatorname{am}^{-1} \theta$ $\left\{ \begin{aligned} u &= \int_z^\infty \frac{dz}{\sqrt{Q}} = \frac{1}{\alpha} \operatorname{am}^{-1} \theta \\ u' &= \int_0^z \frac{dz}{\sqrt{Q}} = \frac{1}{\alpha} (K - \operatorname{am}^{-1} \theta) \end{aligned} \right.$	$z = \beta \operatorname{sn}(\alpha u)$ $z = \alpha / \operatorname{sn}(\alpha u)$ $z = \alpha \operatorname{dn}(\alpha u) / \operatorname{cn}(\alpha u)$
2	$\sqrt{-(z^2 - \alpha^2)(z^2 - \beta^2)}$ $\alpha^2 > \beta^2$	$\alpha > z > \beta$	$z^2 = \alpha^2 - (\alpha^2 - \beta^2) r^2$ $= \alpha^2 \cos^2 \theta + \beta^2 \sin^2 \theta$	$\sqrt{1 - \frac{\beta^2}{\alpha^2}}$	$u = \int_z^\alpha \frac{dz}{\sqrt{Q}} = \frac{1}{\alpha} \operatorname{am}^{-1} \theta$	$z = \alpha \operatorname{dn}(\alpha u)$
3	$\sqrt{(z^2 + \alpha^2)(z^2 - \beta^2)}$	$z > \beta$	$z = \beta / \sqrt{1 - r^2}$ $= \beta \operatorname{sec} \theta$	$\frac{\alpha}{\sqrt{\alpha^2 + \beta^2}}$	$u = \int_z^\infty \frac{dz}{\sqrt{Q}} = \frac{k}{\alpha} \operatorname{am}^{-1} \theta$	$z = \beta \operatorname{cn} \left(\frac{\alpha u}{k} \right)$
4	$\sqrt{-(z^2 + \alpha^2)(z^2 - \beta^2)}$	$z < \beta$	$z = \beta \sqrt{1 - r^2}$ $= \beta \cos \theta$	$\frac{\beta}{\sqrt{\alpha^2 + \beta^2}}$	$u = \int_z^\beta \frac{dz}{\sqrt{Q}} = \frac{k}{\beta} \operatorname{am}^{-1} \theta$	$z = \beta \operatorname{cn} \left(\frac{\beta u}{k} \right)$
5	$\sqrt{(z^2 + \alpha^2)(z^2 + \beta^2)}$	$\alpha > \beta$	$z = \beta r \sqrt{1 - r^2}$ $= \beta \tan \theta$	$\sqrt{1 - \frac{\beta^2}{\alpha^2}}$	$u = \int_0^z \frac{dz}{\sqrt{Q}} = \frac{1}{\alpha} \operatorname{am}^{-1} \theta$	$z = \beta \operatorname{tn}(\alpha u)$

In all cases the substitutions are cases of $z^2 = (A + B \sin^2 \theta) (C + D \sin^2 \theta)$.

1474. **The More General Case** $\int \frac{M}{N} \frac{dx}{\sqrt{Q}}$.

Here M, N are any rational algebraic functions of x , and Q , as before, $=(a_0, a_1, a_2, a_3, a_4)(x, 1)^4$.

By a proper choice of p, q , the transformation

$$x = (p + qz)/(1 + z)$$

has removed terms of odd degree from Q . M/N becomes a rational algebraic function of z separable into two parts, the one an even, the other an odd function of z , expressible as

$$M/N \equiv \phi(z^2) + z\chi(z^2).$$

Hence $\int \frac{M}{N} \frac{dx}{\sqrt{Q}}$ is reducible to $\int \frac{\phi(z^2)}{\sqrt{Q'}} dz + \int \frac{z\chi(z^2)}{\sqrt{Q'}} dz$.

By putting $z^2 = y$ the second integral is immediately reduced to a form integrable by earlier rules.

We have therefore only to consider the first integral.

Now $\phi(z^2)$ is itself separable into two parts, the first integral, the second fractional, and is expressible as

$$\phi(z^2) \equiv \Sigma \lambda z^{2r} + \Sigma \frac{\lambda'}{(\mu + \nu z^2)^s}.$$

But both $\int \frac{z^{2r}}{\sqrt{Q'}} dz$ and $\int \frac{dz}{(\mu + \nu z^2)^s \sqrt{Q'}}$ can, by integration by parts, or the use of reduction formulæ, be connected with the integrals

$$\int \frac{dz}{\sqrt{Q'}}, \quad \int \frac{z^2 dz}{\sqrt{Q'}}, \quad \int \frac{dz}{(\mu + \nu z^2) \sqrt{Q'}} \quad (\text{Arts. 271 to 274}).$$

Accordingly all functions of form $\int \frac{M}{N} \frac{dx}{\sqrt{Q}}$, where M, N, Q are of the forms specified, can be reduced to a series of known integrals, together with one or more of the integrals

$$(i) \int_0^x \frac{dx}{\sqrt{(1-x^2)(1-k^2x^2)}}, \quad (ii) \int_0^x \frac{x^2 dx}{\sqrt{(1-x^2)(1-k^2x^2)}},$$

$$(iii) \int_0^x \frac{dx}{(1+nx^2)\sqrt{(1-x^2)(1-k^2x^2)}}.$$

The second of these, viz.

$$\begin{aligned} &= \frac{1}{k^2} \int_0^x \frac{1 - (1 - k^2 x^2)}{\sqrt{(1 - x^2)(1 - k^2 x^2)}} dx \\ &= \frac{1}{k^2} \times (\text{first integral}) - \frac{1}{k^2} \int_0^x \sqrt{\frac{1 - k^2 x^2}{1 - x^2}} dx \\ &= \frac{1}{k^2} \int_0^\theta \frac{d\theta}{\sqrt{1 - k^2 \sin^2 \theta}} - \frac{1}{k^2} \int_0^\theta \sqrt{1 - k^2 \sin^2 \theta} d\theta. \end{aligned}$$

Therefore any such integration as $\int \frac{M dx}{N \sqrt{Q}}$ can be effected by aid of the three standard Legendrian forms

$$F(\theta, k), \quad E(\theta, k), \quad \Pi(\theta, k, n); \quad k < 1. \quad (\text{See Art. 371.})$$

The same is true of the more general form

$$\int \frac{A + B \sqrt{Q}}{C + D \sqrt{Q}} dx$$

discussed in Art. 1443.

1475. The Case when the Factorisation of Q is unknown.

To effect the foregoing reduction, a knowledge of the factorisation of the quartic Q has been presupposed. When there is a preliminary difficulty in this factorisation, we may still obtain the desired form by a use of the invariants I and J . Suppose the quartic made homogeneous by the introduction of a suitable power of y , and expressed as

$$\begin{aligned} Q &= a_0 x^4 + 4a_1 x^3 y + 6a_2 x^2 y^2 + 4a_3 x y^3 + a_4 y^4 \\ &= (a_0, a_1, a_2, a_3, a_4)(x, y)^4, \end{aligned}$$

and let it be reduced by the linear transformation

$$x = l_1 X + m_1 Y, \quad y = l_2 X + m_2 Y$$

to the form $Q' = (a'_0, a'_1, a'_2, a'_3, a'_4)(X, Y)^4$.

Let $\Delta = l_1 m_2 - l_2 m_1$, viz. the modulus of the transformation.

Then $x dy - y dx = \Delta(X dY - Y dX)$

and $\frac{x dy - y dx}{\sqrt{Q}} = \Delta \frac{X dY - Y dX}{\sqrt{Q'}}$,

i.e. writing $x/y = u$, $X/Y = U$,

$$\frac{du}{\sqrt{(a_0, a_1, a_2, a_3, a_4)(u, 1)^4}} = \Delta \frac{dU}{\sqrt{(a'_0, a'_1, a'_2, a'_3, a'_4)(U, 1)^4}},$$

where

$$u = \frac{l_1 U + m_1}{l_2 U + m_2}.$$

Also

$I \equiv a_0 a_4 - 4a_1 a_3 + 3a_2^2$, $J \equiv a_0 a_2 a_4 + 2a_1 a_2 a_3 - a_0 a_3^2 - a_4 a_1^2 - a_2^3$
are connected with I', J' , the same functions of the accented letters, by the relations $I' = \Delta^4 I$, $J' = \Delta^6 J$, whence $I^3/J^2 = I'^3/J'^2$, in which we have an absolute invariant free from the coefficients of the transformation formulae.

Supposing the ratios $l_1 : m_1 : l_2 : m_2$ to have been so chosen as to make $a_1' = 0$ and $a_3' = 0$, as has been shown to be possible, with real values of these ratios, Q' takes the form

$$a_0' U^4 + 6a_2' U^2 + a_4',$$

which can now be supposed expressed as

$$a_0'(U^2 + p)(U^2 + q),$$

and we have to show that p, q can be found in terms of the original coefficients a_0, a_1, a_2, a_3, a_4 .

We have

$$a_0' = a_0', \quad a_1' = 0, \quad 6a_2' = a_0'(p + q), \quad a_3' = 0, \quad a_4' = a_0' pq.$$

$$I' = a_0' \cdot a_0' pq + \frac{1}{12} a_0'^2 (p + q)^2 = \frac{a_0'^2}{12} [(p + q)^2 + 12pq],$$

$$J' = a_0' \cdot \frac{a_0'}{6} (p + q) \cdot a_0' pq - \frac{a_0'^3}{6^3} (p + q)^3 = \frac{a_0'^3}{216} (p + q) [36pq - (p + q)^2];$$

$$\therefore \frac{I^3}{J^2} = \frac{I'^3}{J'^2} = 27 \frac{[(p + q)^2 + 12pq]^3}{(p + q)^2 [36pq - (p + q)^2]^2};$$

whence

$$\frac{I^3 - 27J^2}{4 \cdot 27 \cdot I^3} = \frac{pq(p - q)^4}{[(p + q)^2 + 12pq]^3};$$

or putting $p = \rho q$,

$$\frac{\rho(\rho - 1)^4}{(\rho^2 + 14\rho + 1)^3} = \frac{I^3 - 27J^2}{4 \cdot 27I^3} = \frac{1}{16K}, \text{ say,}$$

where $K = \frac{27}{4} \frac{I^3}{I^3 - 27J^2}$, and is a known function of the original coefficients. This is a sextic equation to find ρ , viz. the ratio of $p : q$.

1476. Solution of the Sextic.

The equation is obviously of the reciprocal class, and therefore its solution may be reduced to that of a cubic, and the cubic may be solved by Cardan's method.

Writing the equation as $\frac{(\rho^{\frac{1}{2}} - \rho^{-\frac{1}{2}})^4}{(\rho + \rho^{-1} + 14)^3} = \frac{1}{16K}$, put $(\rho^{\frac{1}{2}} - \rho^{-\frac{1}{2}})^2 = \frac{16}{\theta - 1}$.

Then $\rho + \rho^{-1} + 14 = 16 \frac{\theta}{\theta - 1}$, and the equation becomes

$$\left(\frac{16}{\theta - 1}\right)^2 / \left(\frac{16\theta}{\theta - 1}\right)^3 = \frac{1}{16K}; \text{ i.e. } \theta^3 = K(\theta - 1).$$

Now adopting Cardan's method, put $\theta = \eta + \zeta$; then

$$\eta^3 + \zeta^3 + (3\eta\zeta - K)(\eta + \zeta) + K = 0;$$

and taking $\eta\zeta = \frac{1}{3}K$,

$$\eta^3 + \frac{K^3}{3^3} \frac{1}{\eta^3} + K = 0, \text{ a quadratic for } \eta.$$

Hence η and ζ can be found, and therefore also θ . Suppose θ_1 a real root of this equation, then $\rho^{\frac{1}{2}} - \rho^{-\frac{1}{2}} = 4\sqrt{\theta_1 - 1}$, and therefore

$$\rho^{\frac{1}{2}} + \rho^{-\frac{1}{2}} = 2\sqrt{\theta_1 + 3} \sqrt{\theta_1 - 1}.$$

Thus $\sqrt{\rho} = (2 + \sqrt{\theta_1 + 3})\sqrt{\theta_1 - 1}$ and $\rho = (7 + \theta_1 + 4\sqrt{\theta_1 + 3})/(\theta_1 - 1)$.

Then a value of the ratio $p : q$ has been found, say $p_1 : q_1$, where p_1, q_1 are specifically known numbers, so that $p p_1 = q_1 q_1 = s$, say, which remains to be found.

Thus
$$\frac{du}{\sqrt{(a_0, a_1, a_2, a_3, a_4)(u, 1)^4}} = \frac{\Delta}{\sqrt{a_0} \sqrt{(U^2 + p_1 s)(U^2 + q_1 s)}}.$$

Putting $U = \sqrt{s}U'$, we have

$$\frac{du}{\sqrt{(a_0, a_1, a_2, a_3, a_4)(u, 1)^4}} = \frac{\Delta}{s\sqrt{a_0} \sqrt{(U'^2 + p_1)(U'^2 + q_1)}}.$$

Finally,
$$\Delta = \sqrt[4]{I'} = \sqrt[4]{a_0'^2 (p^2 + 14pq + q^2)} = \sqrt[4]{\frac{a_0'^2 s^2}{12I} (p_1^2 + 14p_1q_1 + q_1^2)};$$

whence $\frac{\Delta}{\sqrt{a_0 s}} = \sqrt{\frac{p_1^2 + 14p_1q_1 + q_1^2}{12I}}$, and s is now known, which completes the determination of p and q . We therefore have

$$\int \frac{du}{\sqrt{(a_0, a_1, a_2, a_3, a_4)(u, 1)^4}} = \sqrt{\frac{p_1^2 + 14p_1q_1 + q_1^2}{12I}} \int \frac{dU'}{\sqrt{(U'^2 + p_1)(U'^2 + q_1)}}.$$

1477. Cayley points out that if one of the roots of the sextic for ρ be $\rho = a = \beta^4$, the equation is of the form $\frac{(\rho^2 + 14\rho + 1)^3}{\rho(\rho - 1)^4} = \frac{(a^2 + 14a + 1)^3}{\alpha(a - 1)^4}$, and that the solutions of the equation may be written

$$\beta^4, \frac{1}{\beta^4}, \left(\frac{1 - \beta}{1 + \beta}\right)^4, \left(\frac{1 + \beta}{1 - \beta}\right)^4, \left(\frac{1 - i\beta}{1 + i\beta}\right)^4, \left(\frac{1 + i\beta}{1 - i\beta}\right)^4,$$

which the reader may verify [Elliptic Functions, p. 320.]

1478. When a reduction to the form

$$\int \frac{dU}{\sqrt{a_0' U^4 + 6a_2' U^2 + a_4'}} = \int \frac{dU}{\sqrt{a_0' (U^2 + p)(U^2 + q)}}$$

has been effected, then in case p and q are both real, i.e. $9a_2'^2 > a_0'a_4'$, this factorisation will suffice. But in a case when p and q are imaginary, i.e. $9a_2'^2 < a_0'a_4'$, we put $U = \lambda \sqrt{(1 + T)(1 - T)}$, and we observe that a_0', a_4' could not be opposite signs, for if so $9a_2'^2 > a_0'a_4'$.

We shall choose $\lambda = \sqrt[4]{\frac{a_4'}{a_0'}}$, which will be real. We have

$$dU = \lambda \frac{dT}{(1+T)^{\frac{1}{2}}(1-T)^{\frac{3}{2}}},$$

and

$$\begin{aligned} a_0' U^4 + 6a_2' U^2 + a_4' &= [a_0' \lambda^4 (1+T)^2 + 6a_2' \lambda^2 (1-T)^2 + a_4' (1-T)^2] (1-T)^2 \\ &= 2[(a_4' - 3a_2' \lambda^2) T^2 + (a_4' + 3a_2' \lambda^2)] (1-T)^2 \\ &= 2 \left[\sqrt{\frac{a_4'}{a_0'}} (\sqrt{a_0' a_4'} - 3a_2') \right] \left[T^2 + \frac{\sqrt{a_0' a_4'} + 3a_2'}{\sqrt{a_0' a_4'} - 3a_2'}} \right] (1-T)^2, \end{aligned}$$

and

$$\frac{dU}{\sqrt{a_0' U^4 + 6a_2' U^2 + a_4'}} = \frac{1}{\sqrt{2} [\sqrt{a_0' a_4'} - 3a_2']^{\frac{1}{2}}} \frac{dT}{\sqrt{(1-T^2) \left(T^2 + \frac{\sqrt{a_0' a_4'} + 3a_2'}{\sqrt{a_0' a_4'} - 3a_2'}} \right)}}$$

which is now of real form, since $a_0' a_4' > 9a_2'^2$ for the case considered.

1479. ILLUSTRATIVE EXAMPLE.

It will be instructive to consider one case from several points of view.

Take
$$u \equiv \int_3^x \frac{dx}{\sqrt{x^3 - 5x^2 + 4x + 6}}$$

(a) First let us reduce it to the Legendrian form.

$$x^3 - 5x^2 + 4x + 6 = (x-3)(x^2 - 2x - 2).$$

Put $x = (p+qz)/(1+z)$, $dx = (q-p)dz/(1+z)^2$.

$$x-3 = [(p-3) + (q-3)z]/(1+z). \quad (\text{See Art. 1465.})$$

$$x^2 - 2x - 2 = [(p+qz)^2 - 2(p+qz)(1+z) - 2(1+z)^2]/(1+z)^2.$$

Put $p-3+q-3=0$, $pq-(p+q)-2=0$, i.e. $p+q=6$, $pq=8$.

Take the solution $p=4$, $q=2$.

Then

$$x-3 = (1-z^2)/(1+z)^2, \quad x^2 - 2x - 2 = 2(3-z^2)/(1+z)^2, \quad dz = -2dz/(1+z)^2.$$

Also $x=3$ gives $z=1$;

$$\begin{aligned} \therefore u &= -\sqrt{\frac{2}{3}} \int_1^z \frac{dz}{\sqrt{(1-z^2)(1-\frac{1}{3}z^2)}} = -\sqrt{\frac{2}{3}} \int_{\frac{\pi}{4}}^{\theta} \frac{d\theta}{\sqrt{1-\frac{1}{3}\sin^2\theta}} \quad (z = \sin\theta) \\ &= \sqrt{\frac{2}{3}}(K - \text{sn}^{-1}z), \quad K \text{ being the real quarter-period, mod. } 1/\sqrt{3}; \end{aligned}$$

$$\therefore z = \text{sn}(K - u\sqrt{\frac{3}{2}}) = \text{cn}(u\sqrt{\frac{3}{2}})/\text{dn}(u\sqrt{\frac{3}{2}}),$$

i.e.
$$x-3 \equiv \frac{1-z}{1+z} = \frac{\text{dn } u\sqrt{3/2} - \text{cn } u\sqrt{3/2}}{\text{dn } u\sqrt{3/2} + \text{cn } u\sqrt{3/2}}, \text{ mod. } 1/\sqrt{3}.$$

(b) Next let us reduce to the Weierstrassian form.

$x^3 - 5x^2 + 4x + 6$ being already a cubic expression, it is only necessary to remove the term involving the square of the variable. Put $x = z + \frac{5}{3}$; $x=3$ gives $z = \frac{4}{3}$.

$$(x-3)[(x-1)^2 - 3] = \frac{1}{4}(4z^3 - \frac{6}{3}z^2 + \frac{3}{27}z), \quad I = \frac{6}{3}, \quad J = -\frac{3}{27};$$

$$\therefore u = \int_{\frac{4}{3}}^z \frac{2dz}{\sqrt{4z^3 - \frac{6}{3}z^2 + \frac{3}{27}z}} = \left(\int_{\frac{4}{3}}^z - \int_{\infty}^z \right) \frac{2dz}{\sqrt{4z^3 - \frac{6}{3}z^2 + \frac{3}{27}z}} = 2\omega_1 - 2\wp^{-1}(z),$$

and

$$e_1 = \frac{1}{3}, \quad e_2 = \sqrt{3} - \frac{2}{3}, \quad e_3 = -\sqrt{3} - \frac{2}{3}, \quad k^2 = \frac{e_2 - e_3}{e_1 - e_3} = \frac{4\sqrt{3}}{(\sqrt{3} + 1)^2}, \quad k'^2 = \tan^2 15^\circ,$$

$$\omega_1 = \frac{\bar{K}}{\sqrt{e_1 - e_3}} = \frac{\bar{K}}{\sqrt{2 + \sqrt{3}}} \quad (\text{Art. 1414}),$$

\bar{K} not being the same as K in solution (a), the modulus being a different one.

$$\dots \operatorname{sn}^2 \left(K - \sqrt{2 + \sqrt{3}} \frac{u}{2} \right) = \frac{2 + \sqrt{3}}{x - \frac{1}{3} + \sqrt{3} + \frac{2}{3}} = \frac{2 + \sqrt{3}}{(x - 3) + (2 + \sqrt{3})};$$

$$\dots \frac{\operatorname{cn}^2(u \cos 15^\circ)}{\operatorname{dn}^2(u \cos 15^\circ)} = \frac{1}{(x - 3) \tan 15^\circ + 1} \quad (\text{Art. 1352}),$$

and

$$(x - 3) \tan 15^\circ = \frac{\operatorname{dn}^2(u \cos 15^\circ)}{\operatorname{cn}^2(u \cos 15^\circ)} - 1 = k'^2 \frac{\operatorname{sn}^2(u \cos 15^\circ)}{\operatorname{cn}^2(u \cos 15^\circ)},$$

i.e.

$$x - 3 = \tan 15^\circ \operatorname{tn}^2(u \cos 15^\circ); \operatorname{mod.} \sqrt[4]{3}(\sqrt{3} - 1).$$

(c) The results arrived at by these two processes are of different form, the moduli being different.

Take the integral $\int_{\frac{\pi}{2}}^{\theta} \frac{d\theta}{\sqrt{1 - \frac{1}{3} \sin^2 \theta}}$ occurring in the Legendrian reduction.

Put $\frac{1 - \sin \theta}{1 + \sin \theta} = (2 + \sqrt{3}) \cot^2 \phi$, so that when $\theta = \frac{\pi}{2}$, $\phi = \frac{\pi}{2}$.

Then $\sin \theta = \frac{1 - \cot 15^\circ \cot^2 \phi}{1 + \cot 15^\circ \cot^2 \phi}, \quad \cos \theta = \frac{2\sqrt{\cot 15^\circ} \cot \phi}{1 + \cot 15^\circ \cot^2 \phi},$

$$d\theta = \frac{2\sqrt{\cot 15^\circ} \operatorname{cosec}^2 \phi d\phi}{1 + \cot 15^\circ \cot^2 \phi},$$

and

$$1 - \frac{1}{3} \sin^2 \theta = \frac{2}{3} \frac{1 + 4 \cot 15^\circ \cot^2 \phi + \cot^2 15^\circ \cot^4 \phi}{(1 + \cot 15^\circ \cot^2 \phi)^2}$$

$$= \frac{2}{3} \cdot \frac{\cot^2 15^\circ \cdot \operatorname{cosec}^4 \phi}{(1 + \cot 15^\circ \cot^2 \phi)^2} \left(1 - \frac{\cos 30^\circ}{\cos^2 15^\circ} \sin^2 \phi \right).$$

Hence

$$u = -\sqrt{2} \int_{\frac{\pi}{2}}^{\theta} \frac{d\theta}{\sqrt{1 - \frac{1}{3} \sin^2 \theta}} = -\sqrt{2} \int_{\frac{\pi}{2}}^{\phi} \frac{\sqrt{6}}{\sqrt{\cot 15^\circ} \sqrt{1 - \lambda^2 \sin^2 \phi}} \frac{d\phi}{\sqrt{1 - \lambda^2 \sin^2 \phi}}, \quad \left(\lambda = \frac{\sqrt{\cos 30^\circ}}{\cos 15^\circ} \right)$$

$$= \frac{1}{\cos 15^\circ} \int_{\phi}^{\frac{\pi}{2}} \frac{d\phi}{\sqrt{1 - \lambda^2 \sin^2 \phi}} = \frac{1}{\cos 15^\circ} [\bar{K} - \operatorname{am}^{-1} \phi].$$

Thus $\phi = \operatorname{am} (K - u \cos 15^\circ), \left(\operatorname{mod.} \frac{\sqrt{\cos 30^\circ}}{\cos 15^\circ} \right);$

whence $\sin \phi = \operatorname{sn} (K - u \cos 15^\circ) = \frac{\operatorname{cn} (u \cos 15^\circ)}{\operatorname{dn} (u \cos 15^\circ)}, \operatorname{mod.} \frac{\sqrt{\cos 30^\circ}}{\cos 15^\circ},$

$$\cos \phi = \operatorname{cn} (K - u \cos 15^\circ) = \tan 15^\circ \frac{\operatorname{sn} (u \cos 15^\circ)}{\operatorname{dn} (u \cos 15^\circ)} \quad (\text{Art. 1352}).$$

Hence $\cot \phi = \tan 15^\circ \operatorname{tn} (u \cos 15^\circ),$

and $x - 3 = \cot 15^\circ \cot^2 \phi = \tan 15^\circ \operatorname{tn}^2 (u \cos 15^\circ),$

which is the same result as that obtained in solution (b).

1480. LANDEN'S TRANSFORMATION.

From the above example it appears that the reduction of an elliptic integral to the Legendrian form is not unique.

The transformations

$$x=3+\frac{1-\sin\theta}{1+\sin\theta} \quad \text{and} \quad x=3+\cot 15^\circ \cot^2\phi$$

both succeeded in such a reduction, but the moduli in the two cases were different.

For the general theory of such transformations the reader is referred to Cayley (*E. Functions*) or Greenhill (*E. Functions*).

One well-known transformation, however, must be noticed before leaving the matter, viz. that due to Landen.

Taking two variables θ_1, θ_2 connected by the equation $\sin(2\theta_1-\theta_2)=\mu \sin\theta_2$, so that θ_1 and θ_2 vanish together, we have $\cot(2\theta_1-\theta_2)(2d\theta_1-d\theta_2)=\cot\theta_2 d\theta_2$; whence

$$2d\theta_1 \cdot \cot(2\theta_1-\theta_2)=d\theta_2\{\cot(2\theta_1-\theta_2)+\cot\theta_2\}=\frac{\sin 2\theta_1 d\theta_2}{\sin\theta_2 \sin(2\theta_1-\theta_2)}$$

$$\therefore \frac{2 \sin\theta_2 d\theta_1}{\sin 2\theta_1} = \frac{d\theta_2}{\cos(2\theta_1-\theta_2)} = \frac{d\theta_2}{\sqrt{1-\mu^2 \sin^2\theta_2}}$$

Also $\sin 2\theta_1 \cdot \cot\theta_2 - \cos 2\theta_1 = \mu$, $\cot\theta_2 = (\mu + \cos 2\theta_1) \sin 2\theta_1$;

$$\therefore \operatorname{cosec}^2\theta_2 = (1 + \mu^2 + 2\mu \cos 2\theta_1) \sin^2 2\theta_1$$

and $\frac{\sin^2 2\theta_1}{\sin^2\theta_2} = (1 + \mu)^2 \left[1 - \frac{4\mu}{(1 + \mu)^2} \sin^2\theta_1 \right]$,

$$\therefore \frac{2}{1 + \mu} \int_0^{\theta_1} \frac{d\theta_1}{\sqrt{1 - \frac{4\mu}{(1 + \mu)^2} \sin^2\theta_1}} = \int_0^{\theta_2} \frac{d\theta_2}{\sqrt{1 - \mu^2 \sin^2\theta_2}} \quad u, \text{ say};$$

$$\therefore u = \operatorname{am}^{-1}(\theta_2, \mu) = \frac{2}{1 + \mu} \operatorname{am}^{-1}\left(\theta_1, \frac{2\sqrt{\mu}}{1 + \mu}\right);$$

or, what is the same thing,

$$\sin\theta_1 = \operatorname{sn} \frac{1 + \mu}{2} u, \quad (\operatorname{mod.} \frac{2\sqrt{\mu}}{1 + \mu}); \quad \sin\theta_2 = \operatorname{sn} u, \quad (\operatorname{mod.} \mu),$$

or putting $x_1 \equiv \sin\theta_1, \quad x_2 \equiv \sin\theta_2$,

$$u = \int_0^{x_2} \frac{dx_2}{\sqrt{(1-x_2^2)(1-\mu^2 x_2^2)}} = \frac{2}{1 + \mu} \int_0^{x_1} \frac{dx_1}{\sqrt{(1-x_1^2) \left\{ 1 - \frac{4\mu x_1^2}{(1 + \mu)^2} \right\}}}$$

so that $u = \text{sn}^{-1}(x_2, \mu) = \frac{2}{1+\mu} \text{sn}^{-1}\left(x_1, \frac{2\sqrt{\mu}}{1+\mu}\right)$, and therefore u is expressible in either of these ways as an inverse elliptic function.

Writing λ for $\frac{2\sqrt{\mu}}{1+\mu}$ and $\lambda' = \frac{1-\mu}{1+\mu}$, i.e. $\lambda^2 + \lambda'^2 = 1$, we have $\frac{2}{1+\mu} = 1 + \lambda'$, $\mu = \frac{1-\lambda'}{1+\lambda'}$, and the connection between x_1 and x_2 is obtained from the initial formula

$$\sin(2\theta_1 - \theta_2) = \mu \sin \theta_2, \text{ viz. } 2x_1\sqrt{1-x_1^2}\sqrt{1-x_2^2} - (1-2x_1^2)x_2 = \mu x_2,$$

$$\text{i.e. } \frac{x_2}{\sqrt{1-x_2^2}} = \frac{2x_1\sqrt{1-x_1^2}}{1+\mu-2x_1^2}; \text{ whence } x_2 = (1+\lambda')x_1\sqrt{\frac{1-x_1^2}{1-\lambda^2x_1^2}}.$$

Therefore

$$\text{sn}^{-1}(x_1, \lambda) = \frac{1}{1+\lambda'} \text{sn}^{-1}\left\{(1+\lambda')x_1\sqrt{\frac{1-x_1^2}{1-\lambda^2x_1^2}}, \frac{1-\lambda'}{1+\lambda'}\right\}.$$

This is known as Landen's Transformation.

For many such results and other transformations, see Greenhill, *E.F.*, pp. 55, 56, and Chapter X. Greenhill gives a very elegant interpretation of the above transformation with reference to the motion of a pendulum (pages 318, 319, *E.F.*).

In such transformations, when $F(\theta, k)$ becomes $MF(\theta_2, k')$, F representing the first Legendrian Integral, M is technically known as the "Multiplier," and the relation between k and k' is known as the "Modular Equation." Thus, in the foregoing case the multiplier is $\frac{1}{2}(1+\mu)$, and the modular equation is $\lambda(\mu+1) = 2\sqrt{\mu}$.

1481. ILLUSTRATIVE EXAMPLES.

Ex. 1. Reduce $r = \int_{11}^x \frac{dr}{\sqrt{11}\sqrt{\sqrt{r^4+8r^3+20r^2+56r-20}}}$

to standard Legendrian form.

We have $U \equiv r^4 + 8r^3 + 20r^2 + 56r - 20 \equiv (r^2 + 2r + 10)(r^2 + 6r - 2)$.

Here, with the notation of Art. 1463, $\lambda = 1$, $\mu = 10$; $\lambda' = 3$, $\mu' = -2$,

$$\left. \begin{aligned} pq + (p+q) + 10 &= 0, \\ pq + 3(p+q) - 2 &= 0, \end{aligned} \right\} \text{ giving } \left. \begin{aligned} p+q &= 6, \\ pq &= -16, \end{aligned} \right\}$$

i.e.

$$\left. \begin{aligned} p &= 8, \\ q &= -2, \end{aligned} \right\} \text{ and } x = \frac{p+qz}{1+z} = \frac{8-2z}{1+z}.$$

$$x^2 + 2x + 10 = 10(9 + z^2)/(1+z)^2, \quad x^2 + 6x - 2 = 10(11 - z^2)/(1+z)^2,$$

$$dx = -10dz/(1+z)^2;$$

$$\therefore \frac{dx}{\sqrt{U}} = -\frac{dz}{\sqrt{-(z^2+9)(z^2-11)}},$$

which is Case 4, Art. 1473. Put $z = \sqrt{11} \cos \theta$.

$$\text{Then } \frac{dx}{\sqrt{U}} = \frac{\sqrt{11} \sin \theta d\theta}{\sqrt{11 \sin^2 \theta (20 - 11 \sin^2 \theta)}} = \frac{1}{2\sqrt{5}} \frac{d\theta}{\sqrt{1 - \frac{1}{2} \sin^2 \theta}},$$

and the limits for x corresponding to 0 and θ for θ , are $\sqrt{11} - 3$ to x .

$$\text{Therefore } v = \frac{1}{2\sqrt{5}} \int_0^\theta \frac{d\theta}{\sqrt{1 - \frac{1}{2} \sin^2 \theta}} = \frac{1}{2\sqrt{5}} F\left(\theta, \frac{\sqrt{55}}{10}\right),$$

$$\text{and } 2r\sqrt{5} = \text{cn}^{-1} \frac{1}{\sqrt{11}} \cdot \frac{8-x}{x+2} \pmod{\frac{1}{10}\sqrt{55}}.$$

Ex. 2. Examine the same integral without factorisation. With the notation of Art. 1475,

$$a_0 = 1, \quad a_1 = 2, \quad a_2 = \frac{1}{3}, \quad a_3 = 14, \quad a_4 = -20,$$

$$I = a_0 a_4 - 4a_1 a_3 + 3a_2^2 = -\frac{2}{3} 8^2,$$

$$J = a_0 a_2 a_4 + 2a_1 a_2 a_3 - a_0 a_3^2 - a_4 a_1^2 - a_2^3 = -\frac{8}{27} 2^2,$$

$$\frac{I^3 - 27J^2}{108I^3} = \frac{3^2 \cdot 5^4 \cdot 11}{2^7 \cdot 3^7 \cdot 3}.$$

Hence, following the notation of Arts. 1475, 1476, our equation for θ is

$$\theta^3 = \frac{2^3 \cdot 3^7}{3^2 \cdot 5^4 \cdot 11} (\theta - 1).$$

$$\text{To simplify, let } \theta = \frac{2 \cdot 3^7}{5^2} t;$$

$$\therefore t^3 = \frac{5^2}{3^2 \cdot 11} \left(\frac{2 \cdot 3^7}{5^2} t - 1 \right), \quad \text{i.e. } t^3 = \frac{74}{99} t - \frac{25}{99},$$

of which an obvious root is $t = -1$.

$$\text{Hence } \theta = -\frac{74}{25} \text{ and } \rho + \frac{1}{\rho} + 14 = \frac{16 \times 74}{99}, \quad \text{i.e. } \rho = -\frac{9}{11} \text{ or } -\frac{11}{9}.$$

$$\text{Therefore } \frac{p}{-9} = \frac{q}{11} = s, \text{ say; } p_1 = -9, \quad q_1 = 11.$$

$$\text{Then } \Delta = \sqrt[4]{\frac{s^2}{12I} (9^2 - 14 \cdot 9 \cdot 11 + 11^2)} = \sqrt{s},$$

$$\text{and } v = \frac{\Delta}{s} \int \frac{\sqrt{s} dU'}{\sqrt{(U'^2 - 9)(U'^2 + 11)}} = \int \frac{dU'}{\sqrt{(U'^2 - 9)(U'^2 + 11)}}.$$

Let $U' = 3 \sec \theta'$. Then $x = \sqrt{11} - 3$ gives $Q = 0$, $U' = 3$, $\theta' = 0$;

$$\therefore v = \int_0^{\theta'} \frac{3 \sec \theta' \tan \theta' d\theta'}{\sqrt{9 \tan^2 \theta' (9 \sec^2 \theta' + 11)}} = \frac{1}{2\sqrt{5}} \int_0^{\theta'} \frac{d\theta'}{\sqrt{1 - \frac{1}{2} \sin^2 \theta'}} = \frac{1}{2\sqrt{5}} F\left(\theta', \frac{1}{10}\sqrt{55}\right),$$

which agrees with the result of Ex. 1.

Ex. 3. Consider the integral $u \equiv \int_0^x \frac{x^{-\frac{3}{2}} dx}{\sqrt{1-x^2}}$ [Legendre, *Exercices*, p. 56].

This does not become infinite in the vicinity of $x=0$ (Art. 348).

Put $x=(1+z^2)^{-\frac{1}{2}}$, $dx = -3z(1+z^2)^{-\frac{3}{2}} dz$, $1-x^2 = (3+3z^2+z^4)z^2/(1+z^2)^3$;

$$\therefore u = 3 \int_1^\infty \frac{dz}{\sqrt{z^4+3z^2+3}}.$$

The factorisation of the desired form $(U^2+p)(U^2+q)$ is

$$\left(z^2 + \frac{3+\sqrt{3}}{2}\right)\left(z^2 + \frac{3-\sqrt{3}}{2}\right).$$

Therefore p and q are complex. Following Art. 1478, put

$$z = \sqrt[4]{3} \sqrt{\frac{1+T}{1-T}}, \quad dz = \frac{\sqrt[4]{3} dT}{\sqrt{1-T^2}(1-T)},$$

and $z = \infty$ gives $T=1$, and

$$z^4+3z^2+3 = [(6-3\sqrt{3})T^2 + (6+3\sqrt{3})](1-T)^2;$$

$$\therefore u = 3 \int_1^\infty \frac{\sqrt[4]{3} dT}{\sqrt{1-T^2}(1-T)} \cdot \frac{1-T}{\sqrt[3]{2(\sqrt{3}-1)^2 \left[T^2 + \left(\frac{\sqrt{3}+1}{\sqrt{3}-1} \right)^2 \right]}}$$

$$= \frac{3^{\frac{3}{4}}}{2 \sin 15^\circ} \int_1^\infty \frac{dT}{\sqrt{(1-T^2)(T^2 + \cot^2 15^\circ)}}$$

$$= \frac{3^{\frac{3}{4}}}{2} \operatorname{cn}^{-1} T = \frac{3^{\frac{3}{4}}}{2} \operatorname{cn}^{-1} \frac{z^2 - \sqrt{3}}{z^2 + \sqrt{3}} = \frac{3^{\frac{3}{4}}}{2} \operatorname{cn}^{-1} \frac{x^{-\frac{3}{2}} - \sqrt{3} - 1}{x^{-\frac{3}{2}} + \sqrt{3} - 1},$$

i.e. $u = \frac{3^{\frac{3}{4}}}{2} \operatorname{cn}^{-1} \frac{1 - 2\sqrt{2}r^{\frac{3}{4}} \cos 15^\circ}{1 + 2\sqrt{2}r^{\frac{3}{4}} \sin 15^\circ}, \quad (\operatorname{mod.} \sin 15^\circ).$

PROBLEMS.

1. Find the values of
- I
- and
- J
- for the quartic function

$$\phi \equiv x^4 - 6\lambda x^2 y^2 + y^4,$$

and show that $4\lambda^3 - I\lambda - J = 0$. Form also the Hessian of the quartic, and the discriminant.

2. Examine the modification in the reduction to Weierstrassian form which accrues from the quartic
- Q
- having one root
- α_0
- zero, i. e.
- $\alpha_4 = 0$
- . Show that in this case

$$e_1 = \alpha_0 \frac{\alpha_1 \alpha_2 \alpha_3}{12} \left(\frac{1}{\alpha_2} + \frac{1}{\alpha_3} - \frac{2}{\alpha_1} \right), \quad e_2 = \alpha_0 \frac{\alpha_1 \alpha_2 \alpha_3}{12} \left(\frac{1}{\alpha_3} + \frac{1}{\alpha_1} - \frac{2}{\alpha_2} \right),$$

$$e_3 = \alpha_0 \frac{\alpha_1 \alpha_2 \alpha_3}{12} \left(\frac{1}{\alpha_1} + \frac{1}{\alpha_2} - \frac{2}{\alpha_3} \right),$$

and that

$$k^2 = \frac{1/\alpha_2 - 1/\alpha_3}{1/\alpha_1 - 1/\alpha_3}.$$

3. If
- $\phi \equiv \alpha_0 (x - \alpha_1 y)(x - \alpha_2 y)(x - \alpha_3 y)(x - \alpha_4 y)$
- ,
-
- and
- $P = \alpha_2 - \alpha_3, \quad Q = \alpha_3 - \alpha_1, \quad R = \alpha_1 - \alpha_2,$
-
- $P' = \alpha_1 - \alpha_4, \quad Q' = \alpha_2 - \alpha_4, \quad R' = \alpha_3 - \alpha_4,$

show that $I = \frac{\alpha_0^3}{24} (P^2 P'^2 + Q^2 Q'^2 + R^2 R'^2),$

$$J = -\frac{\alpha_0^3}{432} (QQ' - RR')(RR' - PP')(PP' - QQ'),$$

and

$$\Delta \equiv I^3 - 27J^2 = \frac{\alpha_0^6}{256} P^2 Q^2 R^2 P'^2 Q'^2 R'^2.$$

Also, if $S_1 = \Sigma \alpha_1, S_2 = \Sigma \alpha_1 \alpha_2, S_3 = \Sigma \alpha_1 \alpha_2 \alpha_3, S_4 = \alpha_1 \alpha_2 \alpha_3 \alpha_4$, show that

$$I = \frac{\alpha_0^2}{12} (12S_4 - 3S_1 S_3 + S_2^2), \quad J = \frac{\alpha_0^3}{12^3} \begin{vmatrix} 12, & -3S_1, & 2S_2 \\ -3S_1, & 2S_2, & -3S_3 \\ 2S_2, & -3S_3, & 12S_4 \end{vmatrix}.$$

4. If
- $\phi \equiv x^4 + 6\lambda x^2 y^2 + y^4$
- and the Hessian
- $H = \begin{vmatrix} \phi_{xx} & \phi_{xy} \\ \phi_{xy} & \phi_{yy} \end{vmatrix}$
- ,
-
- show that
- $H - k\phi$
- is a perfect square if
- $k = \lambda, -\frac{1}{2}(\lambda + 1)$
- or
- $-\frac{1}{2}(\lambda - 1)$
- .

5. Show that $\wp^{-1}(z, 76, -120) = \frac{1}{2\sqrt{2}} \operatorname{sn}^{-1} \frac{2\sqrt{2}}{\sqrt{z+5}}; \operatorname{mod.} \frac{\sqrt{7}}{2\sqrt{2}}.$

6. Show that $\wp^{-1}(z, 28, -24) = \frac{1}{\sqrt{5}} \operatorname{dn}^{-1} \sqrt{\frac{z-1}{z+3}}; \operatorname{mod.} \frac{2}{\sqrt{5}}.$

7. Show that $\wp^{-1}(z, 36, 0) = \frac{1}{\sqrt{6}} \operatorname{cn}^{-1} \sqrt{\frac{z}{z+3}}; \operatorname{mod.} \frac{1}{\sqrt{2}}.$

8. Reduce the integral $u = \int_1^x \frac{dx}{\sqrt{-70x^4 + 253x^3 - 327x^2 + 179x - 35}}$

to Weierstrassian form, and show that $u = \wp^{-1}\left(\frac{x}{x-1}\right)$. Show also that it can be expressed in a Legendrian form with a modulus $\frac{1}{2}$, viz. $u = \frac{1}{\sqrt{6}} \operatorname{sn}^{-1} \sqrt{12 \frac{x-1}{7x-5}}$.

9. Show that if $e_1 > e_2 > e_3$ and $e_1 + e_2 + e_3 = 0$, the substitution $z = e_3 + \frac{e_1 - e_3}{x^2}$ will convert the Weierstrassian Integral

$$\int_z^\infty \frac{dz}{\sqrt{4(z-e_1)(z-e_2)(z-e_3)}}$$

into the Legendrian form

$$\frac{1}{\sqrt{e_1 - e_3}} \int_0^x \frac{dx}{\sqrt{(1-x^2)(1-k^2x^2)}}$$

where $k^2 = \frac{e_2 - e_3}{e_1 - e_3}$, and conversely that the substitution $x = \sqrt{\frac{e_1 - e_3}{z - e_3}}$ will convert the standard Legendrian form into the Weierstrassian.

10. Reduce $\int_z^\infty \frac{dz}{\sqrt{4z(z^2 - 9)}}$ to the Legendrian form

$$\frac{1}{\sqrt{6}} \int_0^x \frac{dx}{\sqrt{(1-x^2)(1-\frac{1}{2}x^2)}}$$

and show with the usual notation that

$$K = \omega_1 \sqrt{6}, \quad K - iK' = \omega_2 \sqrt{6}, \quad -iK' = \omega_3 \sqrt{6}.$$

11. Show that $\int_z^\infty \frac{dz}{\sqrt{z(z^2 - 4)}} = \operatorname{sn}^{-1} \frac{2}{\sqrt{z+2}}$.

12. In the standard Legendrian form $\int_0^x \frac{dx}{\sqrt{(1-x^2)(1-k^2x^2)}}$ discuss the degenerate forms assumed when $k=0$ and when $k=1$, and state to what forms $\operatorname{sn}^{-1}x$, $\operatorname{cn}^{-1}x$, $\operatorname{dn}x$ and $\operatorname{tn}x$ ultimately degenerate in these cases.

13. Discuss the integration of the degenerate cases of

$$\int \frac{dx}{\sqrt{(x-\alpha)(x-\beta)(x-\gamma)(x-\delta)}}$$

(i) when $\alpha = \beta$, (ii) when $\alpha = \beta = \gamma$, (iii) when $\alpha = \beta = \gamma = \delta$.

14. Discuss the integration of the degenerate cases of

$$\int_z^\infty \frac{dz}{\sqrt{4(z-e_1)(z-e_2)(z-e_3)}}, \quad \left\{ \begin{array}{l} e_1 > e_2 > e_3, \\ e_1 + e_2 + e_3 = 0 \end{array} \right\},$$

(i) when $e_2 = e_3$, (ii) when $e_1 = e_2$, (iii) when $e_1 = e_2 = e_3$.

15. Express both in Weierstrassian and in Legendrian notation the integration

$$u = \int_0^{\infty} \frac{t dt}{\sqrt{t^6 + 3t^4 - 6t^2 - 8}}.$$

16. Make use of the substitution $x^3 + x^{-3} = 2t^{-\frac{2}{3}}$ to reduce the integral $u = \int_0^x \frac{du}{\sqrt{1+x^6}}$ to the form of an elliptic integral, and reduce it to the standard Weierstrassian form.

17. Use the substitution $t^3 = (1+x+x^2)/(1-x)^2$ in the integration $u = \int_1^x \frac{dx}{(1-x^3)^{\frac{2}{3}}}$; and show that $t = \wp\left(\frac{u}{\sqrt{3}}, 0, 1\right)$.

18. Show that if

$$2u = \int_2^x \frac{dx}{\sqrt{(x-2)(5x-11)(11x-21)(3x-7)}} \quad (2 < x < 2.2),$$

$$u = \wp^{-1}\left(\frac{x-1}{x-2}, 304, -960\right) = \frac{1}{4} \operatorname{sn}^{-1} 4 \sqrt{\frac{x-2}{11x-21}} \pmod{\sqrt{\frac{7}{8}}}.$$

19. Show that the solutions of the sextic equation

$$\frac{(\rho^2 + 14\rho + 1)^3}{\rho(\rho-1)^4} = \frac{(\beta^3 + 14\beta^4 + 1)^3}{\beta^4(\beta^4-1)^4}$$

are $\beta^4, \frac{1}{\beta^4}, \left(\frac{1-\beta}{1+\beta}\right)^4, \left(\frac{1+\beta}{1-\beta}\right)^4, \left(\frac{1-i\beta}{1+i\beta}\right)^4$ and $\left(\frac{1+i\beta}{1-i\beta}\right)^4$.

[CAYLEY.]

20. Transform the integral $u = \int_0^1 \frac{dx}{(1-x^6)^{\frac{2}{3}}}$ into one in which z is the variable by the relation $4x^6(1-x^6) = z^3$, and the result by putting $z^2 = 1/(1+y^2)$; and lastly, by the further transformation

$$y = \sqrt[3]{3} \tan \frac{\phi}{2};$$

showing that $\operatorname{sn}\left(\frac{3^{\frac{1}{3}}}{4^{\frac{1}{3}}} u\right) = \frac{\pi}{2}, \pmod{\sin 15^\circ}$.

Hence show that $u = 1.927622\dots$, and verify this otherwise.

[BERTRAND, *I.C.*, p. 687.]

21. Show by Landen's Transformation $2 \sin(2\phi - \theta) = \sin \theta$ that

$$\int_0^{\frac{\pi}{2}} \frac{d\theta}{\sqrt{1 - \frac{1}{4} \sin^2 \theta}} = \frac{4}{3} \int_0^{\frac{\pi}{3}} \frac{d\phi}{\sqrt{1 - \frac{4}{9} \sin^2 \phi}}.$$

22. Express by means of the Weierstrassian elliptic functions $\wp(u)$, $\zeta(u)$, $\sigma(u)$ the results of the following integrations :

- (i) $\int_z^a \frac{z dz}{\sqrt{z^3-1}}$, ($1 < z$); (ii) $\int_z^a \frac{dz}{(z-2)\sqrt{z^3-1}}$, ($2 < z$);
- (iii) $\int_z^\infty \frac{z^3 dz}{(z-2)^2 \sqrt{z^3-1}}$, ($2 < z$);
- (iv) $\int_x^\infty \frac{dx}{(x-1)(x-2)\sqrt{x^3-5x^2+4x+6}}$, ($3 < x$);
- (v) $\int_x^1 \frac{x dx}{\sqrt{x^4-12x^3+54x^2-100x+57}}$, ($x < 1$).

23. Express by Weierstrassian functions the second Legendrian standard form $\int_0^\theta \sqrt{1-k^2 \sin^2 \theta} d\theta$.

24. Express by Weierstrassian functions the third Legendrian standard form $\int_0^x \frac{dx}{(1-a^2x^2)\sqrt{(1-x^2)(1-k^2x^2)}}$.

25. If $u = \frac{1}{2}\sqrt{11} \int_0^x \frac{dx}{\sqrt{(x^2+x+1)(3x^2+x+1)}}$, prove that

$$x(\sqrt{11} \operatorname{cn} u - \operatorname{sn} u) = 2 \operatorname{sn} u, \quad (\text{mod. } \sqrt{11}). \quad [\text{Ox. II. P., 1913.}]$$

26. If $u = 15 \int_1^x \frac{dx}{\sqrt{1105x^4 - 904x^3 - 210x^2 + 8x + 1}}$, prove that

$$x(3 \operatorname{cn} u - 2 \operatorname{dn} u) = \operatorname{dn} u, \quad (\text{mod. } 1/5). \quad [\text{Ox. II. P., 1915.}]$$

27. If $u = \int_0^x \frac{dx}{(1+x^2-2x^4)^{\frac{1}{2}}}$ express x as a single-valued function of u by help of (i) Jacobi's functions, (ii) Weierstrass' functions.

[MATH. TRIP. II., 1914.]

Prove that $x\sqrt{3} \operatorname{dn}(u\sqrt{3}) = \operatorname{sn}(u\sqrt{3})$, (mod. $\sqrt{2/3}$).

28. Show that the integral

$$\int_{a_1}^x \{(x-a_1)(x-a_2)(x-a_3)(x-a_4)\}^{-\frac{1}{2}} dx$$

is transformed to the integral

$$2 \{(a_4-a_2)(a_1-a_3)\}^{-\frac{1}{2}} \int_0^y \{(1-y^2)(1-k^2y^2)\}^{-\frac{1}{2}} dy$$

by the relations $y^2 = (a_2-a_4)(x-a_1)/(a_2-a_1)(x-a_4)$,

$$k^2 = (a_2-a_1)(a_3-a_4)/(a_3-a_1)(a_2-a_4),$$

and obtain an expression for the general value of the former integral.

[MATH. TRIP. II., 1913.]

29. A heavy particle attached to a fixed point by a light thread of length a oscillates under the action of gravity in a vertical plane. Show that the height of the particle above the lowest point of its path at time t from the lowest position is

$$2a \sin^2 \frac{\alpha}{2} \operatorname{sn}^2 \left(\sqrt{\frac{g}{a}} t \right), \quad \left(\operatorname{mod.} \sin \frac{\alpha}{2} \right),$$

where 2α is the whole angle of swing.

30. Show that the potential of a uniform thin ring at any point is

$$4\gamma ma \int_{r_1}^{r_2} \frac{dr}{\{(r^2 - r_1^2)(r_2^2 - r^2)\}^{\frac{1}{2}}},$$

where γ is the constant of gravitation, m the mass per unit length, a the radius of the ring, r the distance of the point from a point of the ring, r_1 and r_2 the least and greatest values of r . Prove also that the potential may be expressed in the form $8\gamma m \frac{a}{r_1 + r_2} K$, where K is the complete elliptic integral of the first kind with modulus $(r_2 - r_1)/(r_2 + r_1)$. [Ox. II. P., 1914.]

31. A heavy elastic string which is uniform when unstretched is passed through a smooth semicircular tube which is held in a vertical plane with its vertex upwards. The radius of the tube is r . The modulus of the elastic string is equal to the weight of a length r of the unstretched string. It is observed that the two equal portions which hang vertically outside the tube are each equal in length to the radius. Show that the unstretched length of the portion which lies within the tube is

$$\frac{4r}{\sqrt{5}} \operatorname{dn}^{-1} \sqrt{\frac{3}{5}}, \quad \left(\operatorname{mod.} \frac{2}{\sqrt{5}} \right). \quad [\text{Ox. II. P., 1915.}]$$

32. Assuming that the law of central attractive force under which an orbit $u = f(\theta)$ can be described is given by $P/h^2 u^2 = u + \frac{d^2 u}{d\theta^2}$, show that if a particle describes an orbit $r = a \operatorname{cn} \theta \sqrt{3}$ under the action of a central attraction μu^2 , the modulus of the elliptic function is $3^{-\frac{1}{2}}$. [Ox. II. P., 1913.]

33. A particle of unit mass is projected horizontally with velocity u , and moves under gravity in a resisting medium such that the path is a portion of a circle of radius a . Show that the motion will cease after a time $\sqrt{\frac{2a}{g}} \operatorname{dn}^{-1} 2^{-\frac{1}{2}}, \left(\operatorname{mod.} 2^{-\frac{1}{2}} \right)$. [Ox. II. P., 1913.]

34. Show that the area A bounded by the y -axis, the asymptote $x = 1$ and the curve $y^2(x - 1)(x - 3) \{(x - 4)^2 + 3\} = 1$ is

$$\frac{1}{\sqrt[3]{3}} \operatorname{cn}^{-1} \frac{14 - 3\sqrt{3}}{13}, \quad (\text{mod. } \sin 75^\circ).$$

35. If A be the area in the positive quadrant bounded by the curve $2y^2x(x^2 + 4x + 1) = 3$, the coordinate axes and an abscissa x , show that $(x + 1)/(x - 1) = \operatorname{dn} A / \operatorname{cn} A$, (mod. $\tan \pi/6$).

36. A ring is generated by the motion of a circle such that its plane passes through the centre of an ellipse and a perpendicular to the plane of the ellipse through the centre, and the centre of the circle lies on the ellipse. Show that the volume of the ring is $4\pi Kbc^2$, where b is the semi-axis minor of the ellipse, K the complete elliptic integral of the first kind with its modulus equal to the eccentricity of the ellipse and c ($< b$) the radius of the circle.

[C.S., 1895.]

37. Prove that the equation of the osculating plane at any point of the curve $x = a \operatorname{sn} u$, $y = b \operatorname{cn} u$, $z = c \operatorname{dn} u$, (mod. k), is

$$\frac{x}{a} k^2 (1 - k^2) \operatorname{sn}^3 u - \frac{y}{b} k^2 \operatorname{cn}^3 u + \frac{z}{c} \operatorname{dn}^3 u = 1 - k^2.$$

[Ox. II. P., 1902.]

38. An elliptic wire of semi-axes a and b moves so that its plane is always parallel to a fixed plane while its centre describes in a perpendicular plane a circle of radius c which is greater than either a or b , and the minor axis is perpendicular to the latter plane. Prove that the ring surface formed by the circumference of the wire cuts itself in two hyperbolic edges, and that its volume is

$$\frac{16}{3} \frac{bc}{a} \{(c^2 + a^2)E - (c^2 - a^2)K\},$$

where K and E are the complete elliptic integrals of the first and second kinds with modulus a/c .

[MATH. TRIP. 1886.]

39. If the modulus k and the amplitude ϕ of the elliptic integral $F(\phi, k)$ be given by $k = \cos \pi/12$, $\cos \phi = 2 - \sqrt{3}$, then will

$$F(\phi, k) = \{\sqrt[3]{\pi} \Gamma(\frac{1}{3})\} / \{3^{\frac{1}{3}} \cdot \Gamma(\frac{5}{6})\}.$$

[J. C. MALET, *E. T.*, 9677.]

CHAPTER XXXIV.

CALCULUS OF VARIATIONS. (SECTION I.)

1482. To ascertain the greatest or least values of which a given function is susceptible under specific conditions, it has been found necessary in the Differential Calculus to *allow it to grow*, and then to find the magnitude attained when the rate of growth stops. And methods have been formulated by which this rate of variation can be ascertained and tests constructed for the discrimination of maxima values from minima values and from other stationary values which the method may discover.

The functions considered in the *Differential Calculus* have all been expressed directly or indirectly in terms of a set of one or more independent variables not usually involving signs of integration, and if any dependent variables have occurred in the functions under discussion their connection with the independent ones has always been specified and known.

We now have a problem of different nature. We are to consider the maximum or minimum value of a function usually expressed by an integration, in which the integrand contains not only an independent variable or set of independent variables, but also one or more dependent variables and their differential coefficients, *for which the relationship between the dependent ones with the independent ones is not specified, but remains to be discovered*, in order that a stationary value of the integral may result under any conditions with regard to the limits of the integration which may be imposed.

1483. Preliminary Ideas as to the Mode of Procedure.

As before, it will be necessary to allow the function to grow and to ascertain the rate of its growth under the imposed

conditions when the variables it contains are made to vary in an arbitrary and independent manner consistent with the retention of the continuity of the function and consistent with the imposed conditions.

We shall first take the case of one independent variable only, viz. x , and we shall suppose that the form of the relationship between x and the dependent variable y is required which shall be such that the integral with respect to x of a given function V of $x, y, \frac{dy}{dx}, \frac{d^2y}{dx^2}, \dots$, viz. $\int V dx$, acquires a stationary value. For amongst the stationary values the maxima and minima values lie. To fix the ideas we may regard x and y as the Cartesian coordinates of a point. And here it will be observed that y is to be regarded as a function of x , but that the form of this functional connecting relation is unknown and is to be the subject of investigation.

The form of V is supposed known. The limits of the integration may be regarded as being from a point $P, (x_0, y_0)$, to a point $P_1, (x_1, y_1)$, which will be referred to as the terminal points or terminals, and which may be specified either as *fixed points*, or as *points which lie on specific loci*.

It is then our object to discover the relationship between x and y which will compass the object of making $\int V dx$ assume a stationary value with such terminal conditions.

1484. For instance, if we require to find the shortest path in the plane x - y from the given line $x+y=2a$ to the circle $x^2+y^2=a^2$, we have to make $\int ds$, or what is the same thing $\int \sqrt{1+y'^2} dx$, assume a minimum value, where the things at our choice are (i) the positions of the terminal points on their respective loci, (ii) the nature of the path from one terminal to the other. And the solution we should expect will be that there is a linear relation $y=mx+n$ between x and y , and that the values of m and n will be such that the line cuts both the terminal loci at right angles; which we shall presently find to be the case.

1485. The Symbol δ of Arbitrary Variation.

When a known and definite relation exists between x and y , say $y=f(x)$, and when we pass from a definite point $P_1, (x, y)$, on the graph to an adjacent point $P_2, (x+dx, y+dy)$, travelling along the curve, *there is a relation between the differentials dx, dy ,*

viz. $dy=f'(x)dx$, to the first order of infinitesimals, where $f'(x)$ represents the differential coefficient of $f(x)$ with regard to x .

We may, however, assign quite arbitrary independent infinitesimal variations to x and y , and thus pass from the point P_1 to a point Q_1 , *not necessarily upon the curve $y=f(x)$* , but indefinitely close to P_1 , and we shall denote such independent and unconnected arbitrary variations by δx and δy . Thus, in Fig. 431, P_1P_2P being the graph of $y=f(x)$ and P_1N_1 , P_2N_2 , Q_1M_1 perpendiculars upon the axis and P_1SR a parallel to the x -axis cutting Q_1M_1 and P_2N_2 at S and R respectively, we have $dx=N_1N_2$, $dy=RP_2$, $\delta x=N_1M_1$, $\delta y=SQ_1$.

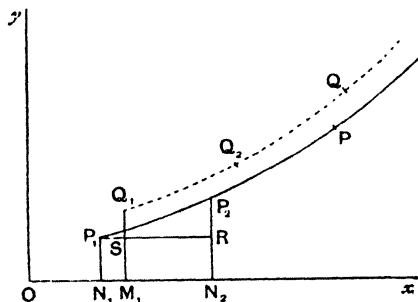

Fig. 431.

1486. Arbitrary Variation of a Path.

If every point of the P -path be thus treated and the variations of the several P -points are such as to give a series of Q -points *which lie upon a continuous curve*, we may regard the P -path as being deformed in an arbitrary manner from point to point into an indefinitely close Q -path, and the arbitrariness in the deformation is such that the deformation at P_1 from P_1 to Q_1 does not in any way fix the law by which the position of P_2 is deformed into the position Q_2 , the only restriction upon the removals of the various points $P_1, P_2, \dots P$ upon the P -path to the corresponding points $Q_1, Q_2, \dots Q$ upon the Q -path being that each such removal shall be through an *infinitesimal distance*, and that the aggregate of the Q -points shall form a continuous curve. This deformation of the P -path, whatever that path may be, whether $f(x)$ be a function of known form or not, is therefore entirely, point by point,

at our choice along the whole path of P , with the exception of the terminals, which in any particular case may have definite loci assigned to them, where there will be definite relations between the terminal values of δx and δy at each end, but the variations at one terminal being quite independent of those at the other.

The processes of the Calculus of Variations are essentially conducted by means of the consideration of such arbitrary differential variations as the δx , δy here defined.

1487. Results of the Differential Calculus which do not involve the nature of the connection between the variables occurring remain the same with the one set of variations dx , dy , ... as with the other δx , δy , Thus, if V be a function of any set of variables x_1, x_2, x_3, \dots , say, $V = \phi(x_1, x_2, x_3, \dots)$, and if these variables receive two sets of variations,

$$(dx_1, dx_2, dx_3, \dots) \text{ and } (\delta x_1, \delta x_2, \delta x_3, \dots),$$

then, if dV and δV be to the first order the corresponding changes in V , we have, whether the variables be connected in any way or not,

$$dV = \frac{\partial \phi}{\partial x_1} dx_1 + \frac{\partial \phi}{\partial x_2} dx_2 + \dots \quad \text{and} \quad \delta V = \frac{\partial \phi}{\partial x_1} \delta x_1 + \frac{\partial \phi}{\partial x_2} \delta x_2 + \dots$$

1488. δ and d Commutative.

We shall now prove that $d(\delta x) = \delta(dx)$.

Let AA_1 be any curve $y = \phi(x)$, and let P, P_1 be contiguous

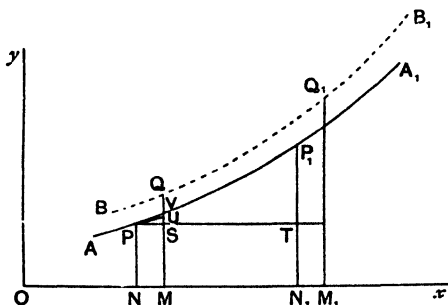

Fig. 432.

points upon it, viz. (x, y) and $(x + dx, y + dy)$ respectively. Let the curve AA_1 be deformed to a contiguous curve BB_1

so that the arbitrary point to point deformation displaces P to Q , P_1 to Q_1 , etc. Let the ordinates NP , N_1P_1 , MQ , M_1Q_1 be drawn, and PST parallel to the x -axis cutting the ordinates of Q and P_1 at S and T , and let PU , the tangent at P , cut the ordinate of Q at U , and let V be the point in which the ordinate of Q cuts the curve AA_1 . Then $NN_1 = dx$, $NM = \delta x$. The change in NM due to a change from x to $x + dx$ is $d(NM)$, i.e. $d(\delta x)$. But $d(NM) = N_1M_1 - NM = MM_1 - NN_1$, which is the arbitrary change in NN_1 due to the deformation of the curve, and is therefore $\delta(dx)$. Hence $d(\delta x) = \delta(dx)$.

1489. It follows that $\delta d(dx) = d\delta(dx) = dd(\delta x)$, etc., and generally $\delta d^n V = d^n \delta d^{n-m} V = d^n \delta V$; and so on. (See Lacroix, *Calc. Diff.*, ii., p. 658.)

1490. δ Commutative with regard to the Sign of Integration.

Let $z = \int V dx$. Then $dz = V dx$, and $d\delta z = \delta dz = \delta(V dx)$.

Therefore integrating $\delta z = \int \delta(V dx)$.

That is
$$\delta \int V dx = \int \delta(V dx).$$

1491. The Quantity ω .

Again, $UQ = SQ - SU = \delta y - y' \delta x$, where y' stands for $\frac{dy}{dx}$, or the tangent of the slope of the curve at P . We shall call this quantity ω . It is the amount by which Q is raised by the variation δy above the tangent line at P , and the distance UV is a second-order infinitesimal. Thus, to the first order, ω or $\delta y - y' \delta x$ is the amount by which Q is raised above the curve $y = \phi(x)$ at the point V .

1492. Differential Coefficients of ω .

Supposing $y = \phi(x)$, consider the variation in $\frac{dy}{dx}$, where x and y are arbitrarily changed to $x + \delta x$ and $y + \delta y$ respectively. We have at once

$$\begin{aligned} \delta \frac{dy}{dx} &= \frac{d(y + \delta y)}{d(x + \delta x)} - \frac{dy}{dx} = \left(\frac{dy}{dx} + \frac{d \delta y}{dx} \right) \left(1 + \frac{d \delta x}{dx} \right)^{-1} - \frac{dy}{dx} \\ &= \frac{d}{dx} \delta y - y' \frac{d}{dx} \delta x, \end{aligned}$$

to the first order of infinitesimals.

Hence

$$\delta y' - y'' \delta x = \frac{d}{dx} \delta y - y' \frac{d}{dx} \delta x - y'' \delta x = \frac{d}{dx} (\delta y - y' \delta x) = \frac{d\omega}{dx} = \omega', \text{ say.}$$

Similarly, $\delta y'' - y''' \delta x = \omega''$, $\delta y''' - y^{(4)} \delta x = \omega'''$; and so on.

1493. Geometrical Proof.

Let $\eta = f(x)$ be a curve such that $\int_a^x \eta dx = y$, i.e. y represents the area bounded by the curve AP (Fig. 433), the ordinates AL, P_1N , viz. $X = a$ and $X = x$, and the x -axis.

Let the curve APP_1 be displaced by an arbitrary infinitesimal point to point deformation to the curve BQQ_1 , A going to B , P to Q , P_1 to Q_1 , etc.

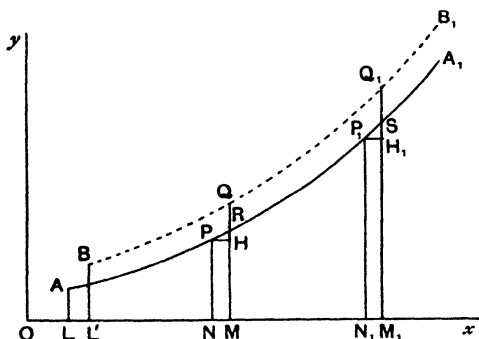

Fig. 433.

Let (x, η) , $(x + \delta x, \eta + \delta \eta)$, $(x + dx, \eta + d\eta)$ be the coordinates of P, Q, P_1 respectively, and draw the ordinates AL, BL' , etc., and PH, P_1H_1 parallel to the x -axis.

Then

$$y = \int_a^x \eta dx = \text{area } LNPA; \quad \delta y = \delta \int_a^x \eta dx = \text{area } L'MQB - \text{area } LNPA,$$

and

$$d(\delta y) = d(\text{area } L'MQB) - d(\text{area } LNPA) = \text{area } MM_1Q_1Q - \text{area } NN_1P_1P. \quad (1)$$

Also $\eta \delta x = \text{area } NMRP$ to the first order;

$$\therefore d(\eta \delta x) = \text{area } N_1M_1SP_1 - \text{area } NMRP. \dots\dots\dots(2)$$

$$\text{Hence } d(\delta y) - d(\eta \delta x) = \text{area } MM_1Q_1Q - \text{area } N_1M_1SP_1 - \text{area } NN_1P_1P + \text{area } NMRP = \text{area } RSQ_1Q,$$

i.e.
$$d\left[\delta \int_a^x \eta dx - \eta \delta x\right] = \text{area } RSQ_1Q,$$

and to the first order $RQ = \delta \eta - \eta' \delta x$; and

$$MM_1 = NN_1 + N_1M_1 - NM = dx + \delta(x + dx) - \delta x = dx + \delta dx.$$

So that to the second order, area $RSQ_1Q = (\delta\eta - \eta' \delta x) dx$;

$$\therefore \frac{d}{dx} \left[\delta \int_a^x \eta dx - \eta \delta x \right] = \delta\eta - \eta' \delta x, \text{ and } \eta = y', \eta' = y'';$$

$$\therefore \frac{d}{dx} [\delta y - y' \delta x] = \delta y' - y'' \delta x, \text{ and } \delta y' - y'' \delta x = \omega'.$$

This geometrical proof appears to be due to the late Dr. E. J. Routh.

1494. Notation.

We shall use accents to denote differentiations with regard to the independent variable x , and when accents become inconvenient by their number, we shall replace them as elsewhere by an index in brackets. Thus $y''' = \frac{d^3 y}{dx^3}$, $y^{(n)} = \frac{d^n y}{dx^n}$.

We shall represent by V any known function of x , y , y' , y'' , ..., $y^{(n)}$; the independent variable being x , and y a function of x of unknown form, and therefore, also, its several differential coefficients being of unknown form.

For the present it is also assumed that V is independent of the limits of integration. We shall adopt the notation and follow the method of De Morgan (*Diff. and Int. Calc.*, p. 449, etc.). In this notation Capitals denote *partial* differentiations of V . Thus

$$X \equiv \frac{\partial V}{\partial x}, \quad Y \equiv \frac{\partial V}{\partial y}, \quad Y' \equiv \frac{\partial V}{\partial y'}, \quad Y'' \equiv \frac{\partial V}{\partial y''}, \text{ etc.},$$

the suffixes indicating the particular differential coefficient of y with regard to which the partial differentiation of V is effected. Also accents will be used in these cases also to denote *total* differentiations with regard to x . Thus

$$Y''' \equiv \frac{d^3}{dx^3} \left(\frac{\partial V}{\partial y''} \right), \text{ etc.}$$

Lagrange, to whom this Calculus is in the first place due, uses a different notation, convenient when no differential coefficients of y beyond the second order occur, but not so convenient otherwise. In Lagrange's notation p stands for y' , q for y'' , etc., and

$$N \equiv \frac{\partial V}{\partial y} \equiv Y, \quad P \equiv \frac{\partial V}{\partial p} \equiv Y', \quad Q \equiv \frac{\partial V}{\partial q} \equiv Y'', \text{ etc.}$$

1495. Variation of $\int V dx$.

Supposing $V \equiv \phi \{x, y, y', y'', \dots, y^{(n)}\}$, where the relationship of y and x is unassigned and held in abeyance, remaining to be chosen to suit circumstances which may arise, let us take AA_1 (Fig. 434) as the graph of a supposititious case of such

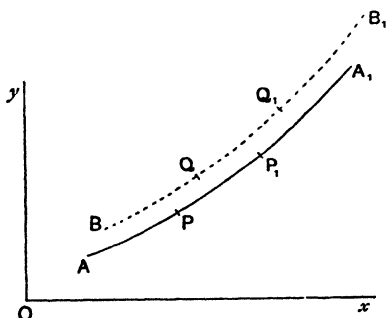

Fig. 434.

relationship, and let us suppose it subjected to a point to point deformation to a contiguous position BB_1 of the kind described. Then we shall find the consequent variation in the integral $u \equiv \int V dx$, where the integration is taken from one terminal point A to another terminal point A_1 , which, like other points on the curve, may be subject to small variations of position, which may, however, in these terminal cases be partially prescribed by the terminal circumstances, A going to B , P to Q , P_1 to Q_1 , etc. Then, since δ is commutative with regard to an integral sign,

$$\begin{aligned} \delta u &= \delta \int V dx = \int \delta(V dx) = \int (\delta V dx + V \delta dx) = \int (\delta V dx + V d \delta x) \\ &= \int \delta V dx + [V \delta x] - \int \delta x dV = [V \delta x] + \int (\delta V dx - dV \delta x), \end{aligned}$$

the integral being taken throughout the whole length of the curve from A to A_1 , and the square brackets $[]_0^1$ or $[]_{x_0}^{x_1}$ round the integrated portion indicating that the included portion is to be taken between the same limits, viz. (x_0, y_0) the coordi-

nates of A to (x_1, y_1) the coordinates of A_1 . Now to the first order,

$$\begin{aligned} \delta V &= X \delta x + Y \delta y + Y' \delta y' + Y'' \delta y'' + \dots + Y_{(n)} \delta y^{(n)}, \\ \text{and } dV &= X dx + Y dy + Y' dy' + Y'' dy'' + \dots + Y_{(n)} dy^{(n)}; \\ \therefore \delta V dx - dV \delta x &= Y(\delta y - y' \delta x) dx + Y'(\delta y' - y'' \delta x) dx \\ &\quad + Y''(\delta y'' - y''' \delta x) dx + \dots \\ &= \{Y\omega + Y'\omega' + Y''\omega'' + \dots + Y_{(n)}\omega^{(n)}\} dx \\ &\quad \text{to the second order.} \end{aligned}$$

Hence to the first order

$$\delta \int V dx = \left[V \delta x \right]_{x_0}^{x_1} + \int_{x_0}^{x_1} \{Y\omega + Y'\omega' + Y''\omega'' + \dots + Y_{(n)}\omega^{(n)}\} dx.$$

1496. The integrand admits of a considerable amount of integration. We have

$$\begin{aligned} \int Y\omega dx &= \int Y\omega dx, \\ \int Y'\omega' dx &= Y\omega - \int Y'\omega dx, \\ \int Y''\omega'' dx &= Y''\omega' - Y'\omega + \int Y''\omega dx, \\ \int Y'''\omega''' dx &= Y'''\omega'' - Y''\omega' + Y''\omega - \int Y'''\omega dx, \\ &\dots \dots \dots \end{aligned}$$

$$\int Y_{(n)}\omega^{(n)} dx = Y_{(n)}\omega^{(n-1)} - Y'_{(n)}\omega^{(n-2)} + \dots + (-1)^{n-1} Y_{(n)}^{(n-1)}\omega + (-1)^n \int Y_{(n)}^{(n)}\omega dx.$$

Now make a further abbreviation, and write

$$\begin{aligned} K &\equiv \bar{Y} \equiv Y - Y' + Y'' - Y''' + \dots + (-1)^n Y_{(n)}^{(n)}, \\ \bar{Y}' &\equiv Y' - Y'' + Y''' - \dots + (-1)^{n-1} Y_{(n)}^{(n-1)}, \\ \bar{Y}'' &\equiv Y'' - Y''' + \dots + (-1)^{n-2} Y_{(n)}^{(n-2)}, \text{ etc.}; \text{ we then have} \end{aligned}$$

$$\delta \int V dx = \left[V \delta x + \bar{Y}'\omega + \bar{Y}''\omega' + \bar{Y}'''\omega'' + \dots + \bar{Y}_{(n)}\omega^{(n-1)} \right]_{x_0}^{x_1} + \int_{x_0}^{x_1} \bar{Y}\omega dx,$$

which may be written for short as

$$\delta \int V dx = H_1 - H_0 + \int K\omega dx \quad \text{or} \quad [H]_0^1 + \int K\omega dx,$$

which gives the variation of the integral to the first order.

Terms of the second and higher orders of the variation are not needed for the present. We shall recur to a consideration

of such terms later when we come to formulate an analytical test for the discrimination between maxima and minima values. But in a large number of cases the nature of the stationary result found will be obvious from the circumstances of the problem without any formal analytical discriminatory test.

1497. We shall now count up the number of first-order variations involved at the terminals. Written at full length to exhibit all these variations, we have, to the first order,

$$\int_{x_0}^{x_1} V dx$$

$$= [V \delta x + \bar{Y}'(\delta y - y' \delta x) + \bar{Y}''(\delta y' - y'' \delta x) + \dots + \bar{Y}^{(n)}(\delta y^{(n-1)} - y^{(n)} \delta x)]_1$$

$$- [V \delta x + \bar{Y}'(\delta y - y' \delta x) + \bar{Y}''(\delta y' - y'' \delta x) + \dots + \bar{Y}^{(n)}(\delta y^{(n-1)} - y^{(n)} \delta x)]_0$$

$$+ \int_{x_0}^{x_1} \bar{Y}(\delta y - y' \delta x) dx,$$

the suffixes to the square brackets having their usual significance. There are in each square bracket $n+1$ variations, viz. $\delta x, \delta y, \delta y', \dots, \delta y^{(n-1)}$; but these are not necessarily all independent.

(i) If the terminals be fixed we have *four* equations of condition, viz. $\delta x=0$ and $\delta y=0$ at each end, and $n-1$ arbitrary variations are left in each bracket, viz. $\delta y', \delta y'', \dots, \delta y^{(n-1)}$, depending upon the direction of the tangent to the path, the curvature, etc., at each terminal.

(ii) If the terminals be not fixed but constrained to lie upon assigned curves, say $y=\chi_0(x), y=\chi_1(x)$, then $\delta y_0=\chi_0'(x_0) \delta x_0, \delta y_1=\chi_1'(x_1) \delta x_1$; so that two conditions are imposed and *two* variations, viz. δy_0 and δy_1 , cease to be arbitrary, which leaves n independent arbitrary terminal variations in each bracket.

(iii) Other terminal stipulations may be made. For instance, if the end x_0, y_0 is to be fixed, and also the direction of departure from that point and the curvature at that point also fixed, this will entail $\delta x_0=0, \delta y_0=0, \delta y_0'=0, \delta y_0''=0$, and the number of arbitrary variations left in that bracket is $n-3$. Similarly, any specific data may be assigned for the other extremity.

Thus, on the whole, there are in the two brackets $2n+2$ terminal variations. Every imposed terminal condition ex-

pressible by one equation, such as $x_0 = a$, $y_0'' = c$, etc., which is to hold at a terminal, reduces the number of independent terminal variations by unity. Hence, if there be p equations of condition, there are $2n + 2 - p$ independent terminal variations. *E.g.* if the terminal (x_0, y_0) be given, and the abscissa of x_1 , and the direction and curvature of the direction of approach to (x_1, y_1) be given, there are 5 equations of condition and $2n - 3$ independent terminal variations.

1498. In the remaining part of the total variation, viz.

$$\int K \omega dx \quad \text{or} \quad \int Y(\delta y - y' \delta x) dx,$$

there are an infinite number of variations, each pair δx , δy indicating the displacement of a point (x, y) of the curve to be found to a hypothetical adjacent position. The function \bar{Y} or K is a linear function of the total differential coefficients with regard to x of the partial differential coefficients of V , standing for $Y - Y' + Y'' - \dots + (-1)^n Y^{(n)}$.

In general $Y^{(n)}$ itself contains $y^{(n)}$, and therefore in general \bar{Y} contains a term $y^{(2n)}$. Hence, if \bar{Y} be equated to zero, as we shall see will be necessary in a search for a stationary value of $\int V dx$, $\bar{Y} = 0$ is in general a differential equation of order $2n$, i.e. of double the order of the highest order differential coefficient occurring in V . The solution of such a differential equation will contain $2n$ arbitrary constants. This is less by 2 than the number of terminal conditions + the number of independent terminal variations, which is $2(n + 1)$.

1499. **Conditions for a Stationary Value of $\int V dx$.**

The same line of argument as that employed in the *Differential Calculus* (Art. 496), in searching for the maxima and minima values of a function of several variables, will now apply in a search for the stationary values of $\int_{x_0}^{x_1} V dx$. It follows that the first order terms of the variation of this integral, viz. $[H]_0^1 + \int_{-}^{x_1} \omega K dx$, must vanish, and further that the coefficients

of the several independent arbitrary variations contained in it must separately vanish.

Now one system of choices of these independent variations will be that in which all variations at each terminal are fixed so that H is made zero at each end. Therefore we must have

in all cases $\int_{x_0}^x K(\delta y - y' \delta x) dx = 0$. Moreover, as $\delta y - y' \delta x$ is arbitrary at every point of the path, it follows that K must vanish as a primary condition. Hence the aggregate of the terms in $[H]_0^1$ must also vanish in any case. And further, since it has been seen that if the number of prescribed terminal conditions be p , the number of independent terminal variations is $2n + 2 - p$, there will be $2n + 2 - p$ relations arising from equating to zero the coefficients of these independent terminal variations.

It has been seen that the solution of the differential equation $K=0$ contains in general $2n$ arbitrary constants (Art. 1498).

It then appears that as the conditions for a stationary value of $\int_{x_0}^{x_1} V dx$, we have

- (1) \bar{Y} or $K=0$, the solution containing $2n$ arbitrary constants,
- (2) $2n + 2 - p$ independent equations arising from $[H]_0^1 = 0$,
- (3) p terminal equations.

Thus we have $2n + 2$ terminal equations in all to find the $2n$ constants, which fix the nature of the path and two other quantities, usually the abscissae of the terminals. The problem is therefore in general completely determinate, as will be seen when we come to discuss examples of the method.

1500. Cases of Integrability of $K=0$.

The chief difficulty in this problem lies in the solution of the differential equation $K=0$, and often this cannot be obtained.

- (1) There is one case in which at least a first integration can be effected in general terms, viz. when V does not explicitly contain x ; i.e. $V = \phi(y, y', y'', \dots, y^{(n)})$.

For now

$$X=0 \quad \text{and} \quad \frac{dV}{dx} = Yy' + Y_1y'' + Y_2y''' + \dots + Y_{(n)}y^{(n+1)}.$$

But

$$\begin{aligned} \int Y y' dx &= \int Y y' dx, \\ \int Y y'' dx &= Y y' - \int Y' y' dx, \\ \int Y y''' dx &= Y y'' - Y' y' + \int Y'' y' dx, \\ &\dots\dots\dots \\ \int Y_{(n)} y^{(n+1)} dx &= Y_{(n)} y^{(n)} - Y'_{(n)} y^{(n-1)} + \dots + (-1)^{n-1} Y^{(n-1)}_{(n)} y' + (-1)^n \int Y^{(n)}_{(n)} y' dx. \end{aligned}$$

Hence $V = \{ \bar{Y} y' + \bar{Y}' y'' + \bar{Y}'' y''' + \dots + Y_{(n)} y^{(n)} \} + C$,
for the coefficient of y' in the integrand of the unintegrated part is K , which vanishes.

(2) Another case of integrability (to a first integral) of the equation $K=0$ is obvious, viz. when V does not contain y , so that Y does not appear. For $K=0$ then becomes

$$Y' - Y'' + Y''' - \dots = 0, \text{ of which a first integral is}$$

$$Y - Y' + Y'' - \dots = \text{const.}, \text{ i.e. } Y = C'.$$

(3) If V contains neither x nor y explicitly, we have also

$$V = C' y' + C + \bar{Y} y'' + \bar{Y}' y''' + \dots + \bar{Y}_{(n)} y^{(n)}.$$

1501. A very Common Case.

If $V = \phi(y, y')$, in which x does not explicitly occur, and no differential coefficients of y beyond the first, we have $V = Y y' + C$, with the condition $V \delta x + Y (\delta y - y' \delta x) = 0$ at each terminal, i.e.

$$[C \delta x + Y \delta y]_0 = 0 \quad \text{and} \quad [C \delta x + Y \delta y]_1 = 0.$$

(1) If the terminal points be fixed, the terminal conditions are identically satisfied, and the two constants which will be present in the final integration of $V = Y y' + C$ will be determined by making the curve obtained pass through the specified points, whose coordinates are in that case known.

(2) If the terminal points are to lie on specific loci

$$y = \chi_0(x), \quad y = \chi_1(x),$$

we have $\delta y_0 = \chi_0'(x_0) \delta x_0$, $\delta y_1 = \chi_1'(x_1) \delta x_1$,

and therefore

$$[C + Y \chi_0'(x_0)]_0 = 0 \quad \text{and} \quad [C + Y \chi_1'(x_1)]_1 = 0.$$

And supposing $y = F(x, C, C')$, the solution of the equation $K=0$, the substitutions of this value of y in the above equations, together with the equations

$$\chi_0(x_0) = F(x_0, C, C'), \quad \chi_1(x_1) = F(x_1, C, C'),$$

suffice to determine the values of the two constants of the differential equation and the abscissae of the terminals of the path. (See Art. 1499.)

1502. ILLUSTRATIVE EXAMPLES.

1. Let us apply the rule to find the nature of the shortest distance between two given points $(x_0, y_0), (x_1, y_1)$, the result to be expected being of course obvious. (See Art. 1484.)

Here $\int ds \equiv \int \sqrt{1+y'^2} dx$ is to be a minimum.

We have

$$V = \sqrt{1+y'^2}, \quad X=0, \quad Y=0, \quad Y_1 = y'/\sqrt{1+y'^2}, \quad V = Y_1 y' + C.$$

Thus $\sqrt{1+y'^2} = y'^2/\sqrt{1+y'^2} + C$, i.e. $\sqrt{1+y'^2} = 1/C$ or $y' = \text{const.} = m$, say.

Then $y = m.x + n$, m and n to be determined so that the straight-line path indicated shall pass through the terminals, i.e.

$$\begin{vmatrix} x, & y, & 1 \\ x_0, & y_0, & 1 \\ x_1, & y_1, & 1 \end{vmatrix} = 0.$$

2. Suppose we require the shortest distance from the curve $y = \chi_0(x)$ to the curve $y = \chi_1(x)$.

Then, in addition to the above, we have terminal conditions at each end, viz. $V \delta x + Y_1(\delta y - y' \delta x) = 0$, i.e. $C \delta x + y'/C \delta y = 0$ or $1 + y' \frac{\delta y}{\delta x} = 0$ at each end, i.e. the straight line is to cut the terminal curves at right angles at each end

Also the equations

$1 + m \chi_0'(x_0) = 0, \quad 1 + m \chi_1'(x_1) = 0, \quad m x_0 + n = \chi_0(x_0), \quad m x_1 + n = \chi_1(x_1)$ determine the four quantities m, n, x_0, x_1 .

It will be noted that maxima as well as minima distances are included in the solution. The discrimination depends upon the nature of the terminal curves, but in particular cases the nature of the result will usually be obvious without formal test.

3. Let us enquire next the nature of the curve for which, with specific terminal conditions, $\int \left(\frac{d^2y}{dx^2}\right)^2 dx$ attains a minimum value. [Lacroix, Calc. D., p. 704.]

Here $V = y''^2, \quad X = Y = Y_1 = 0, \quad Y_2 = 2y'', \quad Y_3 = 0$, etc.

$K=0$ gives

$$\frac{d^2}{dx^2}(2y'') = 0, \quad \text{i.e.} \quad \frac{d^4y}{dx^4} = 0 \quad \text{or} \quad y = C_0 + C_1 \frac{x}{1!} + C_2 \frac{x^2}{2!} + C_3 \frac{x^3}{3!} + \dots \dots (1)$$

The terminal variation conditions are for each end

$$V \delta x + (Y, - Y'')(\delta y - y' \delta x) + Y''(\delta y' - y'' \delta x) = 0. \dots\dots\dots(2)$$

If we impose the condition that the curve is to pass through (0, 0), (a, 0) and its tangent to make with the x-axis angles $\tan^{-1}a$, $\tan^{-1}a'$ at these points, equation (2) is satisfied and

$$0 = C_0, \quad 0 = C_1 \frac{a}{1} + C_2 \frac{a^2}{2!} + C_3 \frac{a^3}{3!}, \quad a = C_1, \quad a' = C_1 + C_2 a + C_3 \frac{a^2}{2!};$$

whence $C_0 = 0$, $C_1 = a$, $C_2 = -2(2a + a')/a$, $C_3 = 6(a + a')/a^2$;

and we have $y = ax - (2a + a')x^2/a + (a + a')x^3/a^2$.

If $a' = -a$, this becomes the parabola $ay = ax(a - x)$, in which case $y'' = -2a/a$, and is constant throughout the curve.

4. *In the case of a bead sliding freely on a smooth wire in a vertical plane under the action of gravity, to find the form of the wire so that the time of descent from one point of the wire to another is the least possible. This curve is called a brachistochrone.*

The energy equation is $v^2 = 2gy$, where y is the vertical distance of the bead at time t from the horizontal line of zero velocity. This gives

$$t = \frac{1}{\sqrt{2g}} \int \frac{ds}{\sqrt{y}} = \frac{1}{\sqrt{2g}} \int \frac{\sqrt{1 + y'^2}}{\sqrt{y}} dx,$$

which is to be a minimum.

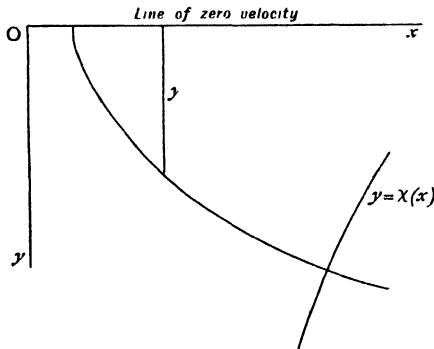

Fig. 435.

Here

$$V = \sqrt{1 + y'^2}/\sqrt{y}, \quad X = 0, \quad Y = -\sqrt{1 + y'^2}/2y^{3/2}, \quad Y' = y'/\sqrt{y}\sqrt{1 + y'^2}.$$

$V = Y, y' + C$ gives $C\sqrt{y}\sqrt{1 + y'^2} = 1$; or, writing

$$y' = \tan \psi \quad \text{and} \quad C = 1/\sqrt{2a},$$

$$y = 2a \cos^2 \psi \quad \text{or} \quad 2a - y = 2a \sin^2 \psi, \dots\dots\dots(1)$$

which indicates an arc of a cycloid with cusps on $y = 0$, i.e. on the line of zero velocity. (*D.C.*, Art. 395.)

At each terminal $V \delta x + Y(\delta y - y' \delta x) = 0$, i.e.

$$C \delta x + Y, \delta y = 0 \quad \text{or} \quad \delta x + y' \delta y = 0. \dots\dots\dots(2)$$

(i) If the terminal points be fixed, equation (2) is identically satisfied.

Equation (1) is only a first integral, but sufficient to determine the nature of the curve.

To proceed with it, $\frac{dy}{dx} = \tan \psi = \sqrt{\frac{2(a-y)}{y}}$,
and putting $y = a(1 + \cos \theta)$, we have

$$dx = -a(1 + \cos \theta) d\theta, \quad \text{i.e.} \quad x - C' = -a(\theta + \sin \theta).$$

So the equations of the curve are

$$\left. \begin{aligned} x &= C' - a(\theta + \sin \theta), \\ y &= a(1 + \cos \theta). \end{aligned} \right\}$$

Moreover, as $y = a(1 + \cos \theta)$ and also $= a(1 + \cos 2\psi)$, we have $\theta = 2\psi$. If the curve is to pass through (x_0, y_0) and (x_1, y_1) , both supposed fixed, we have two equations to determine C' and a , i.e. the position of the cusp and the magnitude of the curve.

If the bead is to start *from rest* at (x_0, y_0) this point must lie on the line of zero velocity, i.e. $y_0 = 0$, and this point is then a cusp of the cycloid.

But if the end (x_0, y_0) be fixed, and the other end (x_1, y_1) is a point only known to lie on a definite locus $y = \chi(x)$, we have $\delta x_0 = \delta y_0 = 0$, $\delta y_1 = \chi'(x_1) \delta x_1$, and the terminal equation at (x_1, y_1) gives $\delta x + y' \delta y = 0$ at that point, i.e. $y' \frac{\delta y}{\delta x} = -1$, and the path cuts $y = \chi(x)$ orthogonally, and the same is true

if (x_1, y_1) be fixed and (x_0, y_0) lies on a fixed locus $y = \chi(x)$, viz. the path must be such as to cut orthogonally the line from which it starts.

If both ends are to lie on fixed curves, viz. $y = \chi_0(x)$, $y = \chi_1(x)$, we have the conditions $y' \frac{\delta y}{\delta x} = -1$ at each end, and therefore each terminal curve is to be cut orthogonally.

If, for instance, the terminal curves be (1) the line of zero velocity, (2) a vertical line at a distance b from the starting point, the starting point is the cusp of the cycloid, and the other terminal is the vertex. The value of a is then found from the equation $b = \pi a$, i.e. $a = b/\pi$, and the constant C is $\sqrt{\pi/2b}$. It will be noted that the starting velocity from (x_0, y_0) on the first curve must be that due to a fall to that point from the line of zero velocity, i.e. $\sqrt{2gy_0}$. Paths starting from any other given horizontal line, and

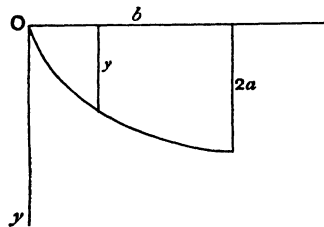

Fig. 436.

therefore with the *same* velocity, and describing paths in the least time to a given curve cut the curve at right angles, but not the straight line, except in the case when the line is the line of zero velocity itself.

The problem just discussed is the celebrated problem of John Bernoulli which gave rise to the Calculus of Variations. It was proposed in the *Acta Eruditorum*, 1696 (see Cajori, *Hist. of Math.*, p. 234). The general problem of brachistochronism for any conservative system of forces will be considered later (Arts. 1537 to 1544).

5. Taking two given points A, B as terminals to find a curve connecting them such that the area bounded by the arc AB , the radii of curvature at A and B and the intercepted arc of the evolute is least. [De Morgan.]

Here $\frac{1}{2} \int \rho ds \equiv \frac{1}{2} \int \frac{(1+y'^2)^2}{y''} dx$ is to be a minimum.

$V = (1+y'^2)^2/y''$, $X = Y = 0$, $Y_1 = 4y'(1+y'^2)/y''$, $Y_2 = -(1+y'^2)^2/y''^2$, and $V = 2C_1y' + 2C_2 + Y_2y''$ gives $(1+y'^2)^2/y'' = C_1y' + C_2$; or, putting $y' = \tan \psi$, $\rho = C_1 \sin \psi + C_2 \cos \psi = A \sin(\psi + B)$, say.

The curve is therefore a cycloid.

The terminal conditions are $V \delta x + \bar{Y}_1(\delta y - y' \delta x) + \bar{Y}_2(\delta y' - y'' \delta x) = 0$ at each end, and since $\delta x = \delta y = 0$ at each end, this reduces to $Y_2 \delta y' = 0$ at each end.

Also $\bar{Y}_2 = Y_2 = -(1+y'^2)^2/y''^2$, and the values of $\delta y'$ at each end are arbitrary. Hence y'' must be ∞ at each end, and the radii of curvature must therefore vanish. The terminals must therefore be cusps of the cycloid.

If a condition be added that these are consecutive cusps the cycloid is then determinate, the length of the chord AB being given, say l , the radius of the rolling circle must be $l/2\pi$. If the cusps be not necessarily consecutive the area might be that contained between a set of such cycloidal arcs as shown in Fig. 438, and their cycloidal evolutes, and it will be obvious that

if the number of these arcs be infinite, the area thus bounded becomes ultimately zero, the radius of the rolling circle having become infinitesimally small.

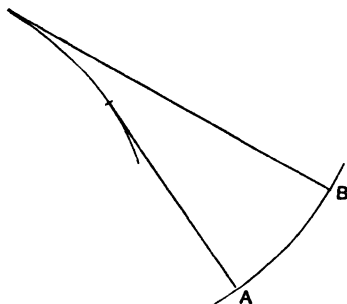

Fig. 437.



Fig. 438.

If the terminals A, B be not fixed but constrained to move on given curves, there is a relation between δx and δy at each end, but the values of $\delta y'$ are still independent and arbitrary; therefore Y_2 still vanishes at

each end, which are cusps of the cycloidal path, which may or may not be consecutive; and other relations also arise by equating to zero the coefficients of δx for each end after substitution of the terminal conditions which give δy in terms of δx .

1503. **The Case when V depends upon the Terminals.**

If V contains the coordinates x_0, y_0 and x_1, y_1 of the terminals and differential coefficients of y_0 and y_1 , in addition to $x, y, y',$ etc., *i.e.*

$$V = \phi(x, y, y', y'', \dots, x_0, x_1, y_0, y_1, y_0', y_1', \dots),$$

the variation δV will include terms in addition to those of Art. 1495, and now

$$\begin{aligned} \delta V = X \delta x + Y \delta y + Y' \delta y' + \dots \\ + \frac{\partial V}{\partial x_0} \delta x_0 + \frac{\partial V}{\partial x_1} \delta x_1 + \frac{\partial V}{\partial y_0} \delta y_0 + \frac{\partial V}{\partial y_1} \delta y_1 + \frac{\partial V}{\partial y_0'} \delta y_0' + \dots, \end{aligned}$$

and these additional terms in the variation $\delta \int V dx$ give rise to

$$\begin{aligned} \delta x_0 \int \frac{\partial V}{\partial x_0} dx + \delta x_1 \int \frac{\partial V}{\partial x_1} dx + \delta y_0 \int \frac{\partial V}{\partial y_0} dx + \delta y_1 \int \frac{\partial V}{\partial y_1} dx \\ + \delta y_0' \int \frac{\partial V}{\partial y_0'} dx + \dots, \end{aligned}$$

the variations $\delta x_0, \delta x_1, \delta y_0,$ etc., not being functions of x but only of the limiting values of x , and the integrations being from x_0 to x_1 as before. These extra terms are all to be added to the terminal variation portion of the total variation $\delta \int V dx$. The differential equation will be unaltered, and the general value of y in terms of x thence derived may be substituted in the several additional integrals above, and their values may then be found and treated as part of the terminal variation [*H*].

1504. **Relative Maxima and Minima. Lagrange's Rule.**

Many problems occur in which $\int V dx$ is to be made a maximum or a minimum with the condition that at the same time a second integral $\int W dx$ is to acquire a given value a , where W , like V , is also a function of $x, y, y', y'',$ etc. For

instance, we might require the curve joining two specified points, such that with the x -axis and the terminal ordinates a maximum area is to be enclosed *whilst the length of the arc between the terminals is given.*

Lagrange solves this relative species of maxima and minima problems by making $\delta \int (V + \lambda W) dx = 0$ unconditionally, where λ is some constant to be determined.

For clearly this gives $\delta \int V dx + \lambda \delta \int W dx = 0$, i.e. $\delta \int V dx$ vanishes for all such relations between y and x as make $\int W dx$ any constant quantity. Now, upon solving this unconditional problem in the way described in the preceding articles, we shall get a relation involving λ as well as the constants of integration, say $y = \phi(\lambda, x, C_1, C_2, C_3, \dots)$. Then substituting for y in $\int W dx$ and integrating, we are to make such a choice of λ as will give the integral $\int W dx$ the stipulated value a .

We then have $\delta \int V dx + \lambda \delta a = 0$, i.e. $\delta \int V dx = 0$, and the variation of $\int V dx$ is zero, and the integral has a stationary value for such a relation between x and y as gives to $\int W dx$ the prescribed constant value a . The constants of integration are to be determined as described before from the terminal conditions.

1505. Illustrative Examples.

1. *To two points A, B given in position, whose distance apart is $2c$, an inextensible thread is attached by its ends, whose length is $2ca \operatorname{cosec} a$. To examine in what curve the thread must be arranged so that the area enclosed by the thread and the chord AB shall be as great as possible.*

Taking the mid-point of AB as origin and OA as x -axis, we are to make $\frac{1}{2} \int p ds$ a maximum with a condition $\int ds = 2ca \operatorname{cosec} a$.

By Lagrange's rule we are to make $u \equiv \int (p + 2\lambda) ds = a$ maximum, i.e. in Cartesians

$$u \equiv \int (y - xy' + 2\lambda \sqrt{1 + y'^2}) dx \text{ is to be a maximum.}$$

Here $V = y - xy' + 2\lambda\sqrt{1+y'^2}$, $X = -y'$, $Y = 1$, $Y_1 = -x + 2\lambda y'/\sqrt{1+y'^2}$, $Y_2 = 0$, etc. Along the path we are to have

$$\bar{Y} \equiv Y - Y_1 = 0 \quad \text{or} \quad 1 = -1 + 2\lambda \frac{d}{dx} \frac{y'}{\sqrt{1+y'^2}}.$$

Hence

$$\frac{y'}{\sqrt{1+y'^2}} = \frac{x-a}{\lambda} \quad \text{and} \quad dy = \frac{(x-a)dx}{\sqrt{\lambda^2 - (x-a)^2}}, \quad \text{i.e. } (x-a)^2 + (y-b)^2 = \lambda^2.$$

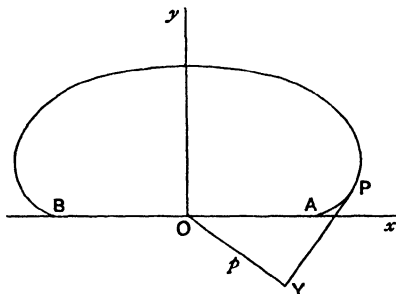

Fig. 439.

Thus the thread must lie on a circular arc of radius $\pm \lambda$ of which AB is a chord. Therefore the centre lies upon the y -axis and $a = 0$.

Let D be the centre and $\hat{A}DO = \beta$. Then $\lambda = \pm c \operatorname{cosec} \beta$, and the length of the arc $= 2(\pi - \beta)c \operatorname{cosec} \beta$, which is to be $2ca \operatorname{cosec} \alpha$; whence

$$\beta = \pi - \alpha, \quad \lambda = \pm c \operatorname{cosec} \alpha \quad \text{and} \quad b = \pm \lambda \cos \beta = -c \cot \alpha.$$

The equation of the arc is therefore $x^2 + (y + c \cot \alpha)^2 = c^2 \operatorname{cosec}^2 \alpha$.

In the limiting case when $c = 0$, $\alpha = \pi$, and if r be the radius

$$L \tan c \cot \alpha = L \tan r \cos \alpha = -r \quad \text{and} \quad L \tan c^2 (\operatorname{cosec}^2 \alpha - \cot^2 \alpha) = c^2 = 0,$$

and the equation becomes $x^2 + y^2 = 2ry$, where $2\pi r = l$, the length of the thread. The thread then forms a complete circle $x^2 + y^2 = ly/\pi$.

Incidentally this shows that the closed curve of given perimeter and greatest area is a circle. The process is the same if we require the curve of least perimeter with a given area, which is therefore also a circle.

Note also that if the length of the thread exceeds πc , the curve will cut the ordinates drawn at A and B and lie partly outside

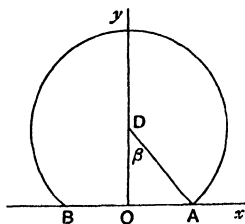

Fig. 440.

them. For this reason we did not express the area as $\int y dx$, for in that case the limits $-c$ to $+c$ for x would not contain the whole area bounded, but only so much of it as lies between the ordinates at A and B , and there would be the difficulty of assigning such limits for the integration as would give the whole area.

A Case of Discontinuity.

If the condition be superimposed that the thread in the above example is not allowed to extend beyond the ordinates at *A* and *B*, we should prefer to begin by expressing the area as $\int_{-c}^c y dx$. But when $l > \pi c$ a discontinuity will be introduced by the imposition of the new condition. We still have the condition $\int \sqrt{1+y'^2} dx = \text{the given length} = l$. Hence

$$\int (y + \lambda \sqrt{1+y'^2}) dx$$

is to be an unconditional maximum, where λ is a constant to be determined.

Here $Y = y + \lambda \sqrt{1+y'^2}$, $X = 0$, $Y = 1$, $Y_r = \lambda y' / \sqrt{1+y'^2}$, $Y_{rr} = 0$, etc.;

$$\therefore y + \lambda \sqrt{1+y'^2} = \lambda \frac{y'^2}{\sqrt{1+y'^2}} + b, \text{ where } b \text{ is a constant. } \dots\dots(1)$$

Hence

$$\frac{\lambda}{\sqrt{1+y'^2}} = b - y, \text{ i.e. } \frac{(y-b)dy}{\sqrt{\lambda^2 - (y-b)^2}} = dx \text{ and } (x-a)^2 + (y-b)^2 = \lambda^2.$$

So long as $l > \pi c$ this will lead to the same solution as before. But the arc is now, by the new condition, precluded from lying outside the ordinates at *A* and *B*, and therefore, for the case where $\lambda > \pi c$, we must re-examine the problem. Now, it has been assumed in the reduction of equation (1) and in integrating, that y' is finite throughout.

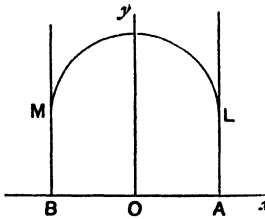

Fig. 441.

But equation (1) can be satisfied by making y' infinite, which indicates that part of the boundary of the area may be a straight line perpendicular to *AB*. Examine next the limiting conditions along the ordinates *AL*, *BM* at the extremities of the chord: δx is to be zero, but δy is arbitrary. Now, for the terms involving the terminal variations

$$[Y \delta x + Y_r (\delta y - y' \delta x)] = 0,$$

and if the thread be arranged as *AL* and *BM*, straight portions, with an arc of a circle *LM*, which satisfies equation (1), we have at *A*, *L*, *M*, *B*, i.e. at the terminals and at the points where the thread leaves the ordinates, $\delta x = 0$; whilst at *A* and *B*, δy is also zero. This reduces the conditions to $[Y_r \delta y] = 0$.

That is $(Y_r \delta y \text{ at } A - Y_r \delta y \text{ at } L)$ for the line *AL* + $(Y_r \delta y \text{ at } L - Y_r \delta y \text{ at } M)$ for the circular arc + $(Y_r \delta y \text{ at } M - Y_r \delta y \text{ at } B)$ for the line *MB* = 0, and δy at *L* is independent of δy at *M*.

Hence Y_r for the line *AL* at *L* = Y_r for the circle at *L* }
 and Y_r for the line *BM* at *M* = Y_r for the circle at *M*. }

But in each case $Y/\lambda \equiv \frac{y'}{\sqrt{1+y'^2}}$ becomes 1 for the lines, y' being infinite. Hence $\frac{y'}{\sqrt{1+y'^2}} = 1$ for the circle also, both at L and at M . Therefore $y' = \infty$ for the circle at L and M , and the circle touches both the ordinates. The area in question is therefore that of a rectangle surmounted by a semicircle, and is such that $l = AL + MB + \frac{1}{2}\pi AB$, which gives the lengths of the straight portions as $\frac{1}{2}(l - \pi c)$, when $l > \pi c$.

2. *The ends of a uniform heavy chain of given length l slide freely upon two smooth curves which lie in the same vertical plane. Let us investigate its form on the supposition from the energy condition of stability that the centroid of the arc will assume the lowest possible position.*

Let the chain assume a position such as indicated by AB in Fig. 442, the terminal curves being $y = f_0(x)$, $y = f_1(x)$. We assume it as obvious

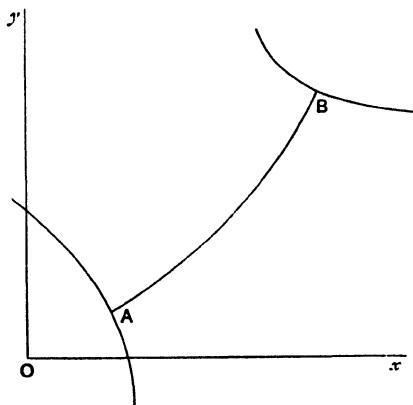

Fig. 442.

that the chain will hang in the vertical plane of the terminal curves. Take any horizontal line in that plane as x -axis. For the position of this x -axis shown in the figure we are to make $\int y ds / \int ds$ a minimum with condition $\int ds = l$. Therefore, by Lagrange's rule we are to make $\int (y + \lambda)\sqrt{1+y'^2} dx$ a minimum.

The equation $V = Y, y' + C$ gives $(y + \lambda)\sqrt{1+y'^2} = (y + \lambda)y'/\sqrt{1+y'^2} + C$, i.e. $y + \lambda = C\sqrt{1+y'^2} = C \sec \psi$, where $y' = \tan \psi$. This is enough to indicate that the chain is to lie in the arc of a certain catenary curve.

Proceeding further with the integration,

$$\frac{C dy}{\sqrt{(y + \lambda)^2 - C^2}} = dx, \quad \text{i.e. } \frac{y + \lambda}{C} = \cosh \frac{x + C'}{C},$$

where C' is a new constant. The catenary is therefore one with its vertex at $(-C', -\lambda + C)$ and with parameter C .

As to the terminals, we are to have $[V\delta x + Y, (\delta y - y'\delta x)] = 0$.

But $\delta y_1 = f_1'(x_1)\delta x_1$, $\delta y_0 = f_0'(x_0)\delta x_0$, so that only two of the four variations at the terminals are independent, and we have $C\delta x + C'y'\delta y = 0$ at each end, i.e. $1 + y'\frac{\delta y}{\delta x} = 0$ at each end, and therefore each of the terminal curves is cut at right angles by the curve of the chain.

The seven quantities $x_0, y_0, x_1, y_1, C, C'$ and λ are determinable from the seven equations

$$y_0 = f_0(x_0), \quad y_1 = f_1(x_1), \quad \frac{y_0 + \lambda}{C} = \cosh \frac{x_0 + C'}{C}, \quad \frac{y_1 + \lambda}{C} = \cosh \frac{x_1 + C'}{C},$$

$$f_0'(x) \sinh \frac{x_0 + C'}{C} = -1, \quad f_1'(x_1) \sinh \frac{x_1 + C'}{C} = -1,$$

$$C \sinh \frac{x_0 + C'}{C} \sim C \sinh \frac{x_1 + C'}{C} = l.$$

3. A vessel which is in the form of a surface of revolution with parallel circular ends of given diameters is just filled with an inelastic fluid. The capacity of the vessel is given and the whole fluid is made to revolve about the axis at a definite angular velocity ω . It is required to find the shape of the vessel so that the "whole pressure" upon the curved surface is a minimum, neglecting the effect of gravity.

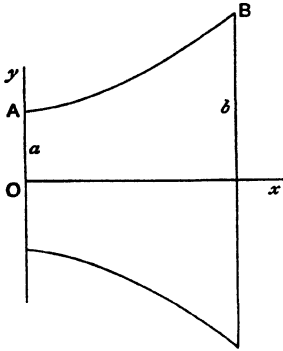

Fig. 443.

Take the origin at the centre of one end and the axis of figure as x -axis. Let the radii of the ends be a and b and the length of the axis x_1 . Taking the density as unity the hydrostatic pressure equation gives $dp = \omega^2 y dy$, where p is the pressure at any point; whence $p = \frac{1}{2}\omega^2 y^2$, for p vanishes along the axis by the condition of the vessel being just full.

Now, the quantity known as "whole pressure" is given by $\int p dS$, where S is an element of surface.

Thus $\int \frac{\omega^2 y^2}{2} 2\pi y \sqrt{1+y'^2} dx$ is to be a minimum with condition $\int \pi y^2 dx = a$ given quantity.

Hence $\int (y^3 \sqrt{1+y'^2} + \lambda y^2) dx$ is to be an unconditional minimum.

So $y^3 \sqrt{1+y'^2} + \lambda y^2 = y^3 y'^2 / \sqrt{1+y'^2} + C$, i.e. $y^3 / \sqrt{1+y'^2} + \lambda y^2 = C$, and for the terminals $[V\delta x + Y, (\delta y - y'\delta x)] = 0$, and at the end through the origin δx and δy both vanish, whilst at the other end $\delta y = 0$, for the radius is fixed, i.e. $C\delta x = 0$, and therefore as δx is not necessarily zero, $C = 0$.

Hence $y/\sqrt{1+y'^2} = -\lambda$ or $y \cos \psi = -\lambda$, where $y' = \tan \psi$. This indicates that the arc of the generating curve is a catenary with parameter $-\lambda$, and directrix along the axis of revolution.

The constants of the catenary and the value of λ are determinable from the facts that the curve is to pass through $(0, a)$, (x_1, b) , and that the vessel is to have a given capacity U .

If the abscissa of the vertex be ξ , we have for the equation of the curve $\frac{y}{-\lambda} = \cosh \frac{x-\xi}{-\lambda}$.

Hence $\frac{a}{-\lambda} = \cosh \frac{\xi}{\lambda}$, $\frac{b}{-\lambda} = \cosh \frac{x_1-\xi}{-\lambda}$, $\pi \int_0^{x_1} \lambda^2 \cosh^2 \left(\frac{x-\xi}{-\lambda} \right) dx = U$, three equations to determine ξ , x_1 and λ .

4. If the assumption be adopted that the pressure upon a small element dS moving with uniform velocity u in a still fluid is normal to dS , and proportional to the square of the normal velocity, it is required to find the form of a surface of revolution with a flat base which, when it moves in the direction of its axis, will experience the least resistance upon its curved surface. (Lacroix, Calc. Diff., ii., p. 698.)

Let ψ be the inclination of the tangent to the axis of figure. The resolved pressure is then $\int 2\pi y ds. ku^2 \sin^2 \psi. \sin \psi$, which $\propto \int \frac{yy'^3 dx}{1+y'^2}$.

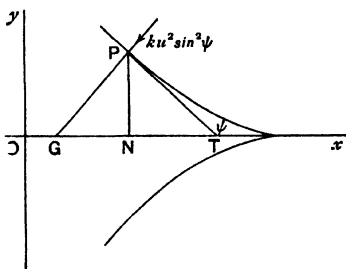

Fig. 444.

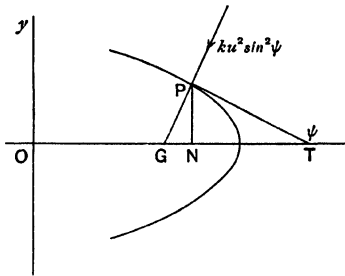

Fig. 445.

Here $V = yy'^3/(1+y'^2)$, $Y = y(3y'^2 + y'^4)/(1+y'^2)^2$.

Therefore for a minimum $V = Y, y' + \text{const.}$ yields

$$yy'^3/(1+y'^2)^2 = \text{const. or } y \cos \psi \propto \text{cosec}^3 \psi.$$

That is, the generating curve must be such that the projection of the ordinate upon the normal varies as the cube of the secant of the inclination of the normal to the axis

If we add the condition that the flat base is to be of given area, and that the volume of the solid is to be given, we have the conditional equation

$$\pi \int y^2 dx = \text{a given constant.}$$

Then $V = yy'^3/(1+y'^2) + \lambda y^2$, $Y = y(3y'^2 + y'^4)/(1+y'^2)^2$; whence

$$\lambda y^2 - \frac{2yy'^3}{(1+y'^2)^2} = C, \quad \text{i.e. } \lambda y^2 - 2y \sin^3 \psi \cos \psi = C. \quad \dots\dots\dots (1)$$

For the terminals $[V\delta x + Y(\delta y - y'\delta x)] = 0$, i.e. $[C\delta x + Y\delta y] = 0$.

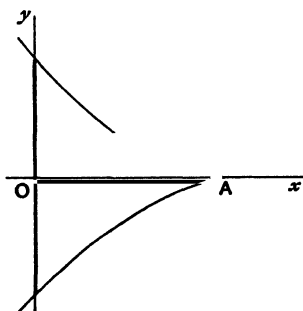

Fig. 446.

The origin being taken at the centre of the flat base (Fig. 446), and the base being given, we have δx and δy both zero for the terminal of the generating curve which lies on the y -axis. Also $C\delta x + Y\delta y$ must vanish at the other terminal. Rejecting the supposition of a discontinuous flat-nosed surface, this other terminal must be on the x -axis and $\delta y = 0$. But δx is arbitrary. Hence $C = 0$. Rejecting also the solution of an end-on straight line experiencing zero resistance, we have

$$y = \frac{2}{\lambda} \sin^3 \psi \cos \psi.$$

It follows that $\frac{ds}{d\psi} = \frac{ds}{dy} \frac{dy}{d\psi} = -\frac{1}{\sin \psi} \cdot \frac{2}{\lambda} (3 \sin^2 \psi - 4 \sin^4 \psi) = -\frac{2}{\lambda} \sin 3\psi$

and

$$s = \frac{2}{3\lambda} \cos 3\psi + \text{const.},$$

which indicates that the generating curve is part of a three-cusped hypocycloid, and the values of λ and the constant may be found from the given data.

1506. The Case where $V dx$ is a Perfect Differential.

We have assumed so far that $\int V dx$ is not directly integrable. If however this be so, the function is free from an integral sign and merely depends upon the terminal values of x, y and the differential coefficients, and is independent of the path of integration from the one terminal to the other. We are therefore not much concerned with this case. Such

a case would occur if, for instance, $V = \frac{xy'' - y'}{x^2}$, for then

$$\int_{x_0}^{x_1} V dx = \int_{x_0}^{x_1} \frac{d}{dx} \left(\frac{y'}{x} \right) dx = \left[\frac{y'}{x} \right]_{x_0}^{x_1}.$$

1507. Tests of Integrability.

Our method of procedure, however, yields a test of integrability. For supposing V to be the differential coefficient of some function of form $F(x, y, y', \dots, y^{(n-1)})$,

$$\delta \int_{x_0}^{x_1} V dx = \delta \left[F(x, y, y', \dots, y^{(n-1)}) \right]_{x_0}^{x_1},$$

and assuming the variation to be one which does not affect the terminal values of the variables, this vanishes independently of any assigned

relation between x and y . That is, the relation $Y=0$ is identically satisfied. And the converse is also true, and the condition is sufficient as well as necessary.

For the demonstration of this converse the student may be referred to Todhunter, *Int. Calc.*, p. 365.

1508. Two or more Dependent Variables.

Let V be a function of one independent variable x and two or more dependent variables y, z with their differential coefficients with regard to x , and suppose we are to search for the nature of this dependence which will give a stationary value to $\int V dx$.

Here $V = F(x, y, y', y'', \dots, z, z', z'', \dots)$. We may proceed to find the first order variation of the integral exactly as before, but it is necessary to extend our notation.

Let $\frac{\partial V}{\partial x} = X, \quad \frac{\partial V}{\partial y^{(n)}} = Y_{(n)}, \quad \frac{\partial V}{\partial z^{(n)}} = Z_{(n)},$

$$\eta^{(n)} = \delta y^{(n)} - y^{(n+1)} \delta x, \quad \xi^{(n)} = \delta z^{(n)} - z^{(n+1)} \delta x,$$

$$Y_{(n)} - Y'_{(n+1)} + Y''_{(n+2)} - \dots = \bar{Y}_{(n)}, \quad Z_{(n)} - Z'_{(n+1)} + Z''_{(n+2)} - \dots = \bar{Z}_{(n)}.$$

Then, just as before, the first order variation of $\int V dx$ is

$$\delta \int V dx = \left[V \delta x + \bar{Y}_{(n)} \eta + \bar{Y}_{(n+1)} \eta' + \dots \right] + \int (\bar{Y}_{(n)} \eta + \bar{Z}_{(n)} \xi) dx$$

or $= [H] + \int (\bar{Y}_{(n)} \eta + \bar{Z}_{(n)} \xi) dx,$

a result similar to that of Art. 1496.

Obviously, a similar form will hold however many dependent variables there may be.

1509. The Subsequent Procedure.

As in the case of one dependent variable, in a search for the forms of the functions y and z which will give $\int V dx$ a stationary value, we are to put $\delta \int V dx = 0$, and now two cases arise, viz.

- (i) When y and z are independent functional forms;
- (ii) when they are connected by an equation $L=0$.

(i) In the first case, $\eta \equiv \delta y - y' \delta x$ and $\xi \equiv \delta z - z' \delta x$ are independent variations, and we get $\bar{Y} = 0$ and $\bar{Z} = 0$ separately, which form two differential equations to determine y and z in terms of x .

(ii) In the second case, η and ξ are not independent variations, but we have $\bar{Y}\eta + \bar{Z}\xi = 0$, together with $L = 0$.

We shall consider these cases in detail.

1510. Case I. y and z independent.

Here

$$\bar{Y} \equiv Y - Y' + Y'' - \dots = 0, \quad \bar{Z} \equiv Z - Z' + Z'' - \dots = 0.$$

Besides these equations, in the event of V not explicitly containing x , we have, as in Art. 1500,

$$V = (\bar{Y}, y' + \bar{Y}_n, y'' + \dots) + (\bar{Z}, z' + \bar{Z}_n, z'' + \dots) + C.$$

And further special cases arise. For instance, if y and z are also absent from V , we have

$$Y' - Y'' + \dots = 0 \quad \text{and} \quad Z' - Z'' + \dots = 0,$$

whence $\bar{Y}_n = C_1$ and $\bar{Z}_n = C_2$;

$$\therefore V = C_1 y' + C_2 z' + C + \bar{Y}_n y'' + \dots + \bar{Z}_n z'' + \dots;$$

and similarly in other cases.

Also, if other dependent variables be present, a corresponding modification of these results will obviously hold.

1511. Case II. The Case when the Path lies on a Specified Surface.

Before considering Case II. in detail, viz. y and z independent, we may point out one very useful case which follows immediately from what has been said, viz. the case where the equation $L = 0$ is a relation between x , y and z alone. This equation is that of a surface on which the path to be discovered must necessarily lie. And the case is useful for the very large class of problems dealing with maxima or minima conditions for lines drawn upon a given surface.

In addition to $\bar{Y}\eta + \bar{Z}\xi = 0$, we have

$$L_x dx + L_y dy + L_z dz = 0 \quad \text{and} \quad L_x \delta x + L_y \delta y + L_z \delta z = 0.$$

Multiplying the first by $\delta x / dx$ and subtracting, we have $L_y \eta + L_z \xi = 0$; whence, eliminating η and ξ , $\bar{Y} / L_y = \bar{Z} / L_z$ and $L = 0$ for all such cases.

1512. Next suppose the equation of condition to contain x, y, z and differential coefficients of y and z with regard to x , viz.

$$L \equiv f(x, y, y', y'', \dots, z, z', z'', \dots) = 0.$$

Lagrange adopts a method similar to that of Art. 1504, and makes

$$\delta \int (V + \lambda L) dx = 0 \text{ without condition,(1)}$$

where he regards λ as a function of x only.

It is clear that this will make $\delta \int V dx$ vanish for all such values of the variables as make $L=0$, which is what we require.

Now

$$\begin{aligned} \delta \int \lambda L dx &= \int (L dx \cdot \delta \lambda + \lambda dx \cdot \delta L + \lambda L \cdot d \delta x) \\ &= [\lambda L \delta x] + \int \lambda (\delta L dx - dL \delta x) + \int L (\delta \lambda dx - \delta x d\lambda). \end{aligned}$$

The first term is a function of the variables and variations at the terminals only, and vanishes with L .

The third term is the only one in which variations of λ appear. And it will be noticed that if λ be regarded as a function of x only, say $\lambda = \chi(x)$, then since $d\lambda = \chi'(x) dx$ and $\delta \lambda = \chi'(x) \delta x$, we have $\delta \lambda dx - \delta x d\lambda = 0$, so that the suppositions (i) $L=0$, (ii) $\lambda = \chi(x)$ produce in that term the same result.

Therefore, in finding the variation $\delta \int (V + \lambda L) dx$ without condition, it is unnecessary to consider variations of λ when we consider λ to be a function of x alone. The variation of $\int \lambda L dx$ therefore produces in the unintegrated part of $\delta \int (V + \lambda L) dx$, the additional term $\int \lambda \left(\delta L - \frac{dL}{dx} \delta x \right) dx$.

1513. Regarding λ therefore as a function of x alone, and writing $V + \lambda L$ instead of V , let us put

$$[Y] \equiv \frac{\partial}{\partial y} (V + \lambda L), \quad [\bar{Y}] \equiv \frac{\partial}{\partial y'} (V + \lambda L), \text{ etc.},$$

the square brackets indicating that the substitution of $V + \lambda L$ for V has been made therein. Thus

$$\delta \int (V + \lambda L) dx = \left\{ [V] \delta x + [\bar{Y}',] \eta + [\bar{Y}'',] \eta' + \dots \right. \\ \left. + [\bar{Z}',] \xi + [\bar{Z}'',] \xi' + \dots \right. \\ \left. + \int ([\bar{Y}] \eta + [\bar{Z}] \xi) dx; \right.$$

and as the variation is unconditional, we have η and ξ independent and $[\bar{Y}] = 0, [\bar{Z}] = 0$; that is

$$\frac{\partial}{\partial y} (V + \lambda L) - \frac{d}{dx} \frac{\partial}{\partial y'} (V + \lambda L) + \frac{d^2}{dx^2} \frac{\partial}{\partial y''} (V + \lambda L) - \dots = 0$$

$$\text{and } \frac{\partial}{\partial z} (V + \lambda L) - \frac{d}{dx} \frac{\partial}{\partial z'} (V + \lambda L) + \frac{d^2}{dx^2} \frac{\partial}{\partial z''} (V + \lambda L) - \dots = 0,$$

i.e. λ being a function of x alone,

$$\left. \begin{aligned} \bar{Y} + \lambda \frac{\partial L}{\partial y} - \frac{d}{dx} \left(\lambda \frac{\partial L}{\partial y'} \right) + \frac{d^2}{dx^2} \left(\lambda \frac{\partial L}{\partial y''} \right) - \dots = 0 \\ \text{and } \bar{Z} + \lambda \frac{\partial L}{\partial z} - \frac{d}{dx} \left(\lambda \frac{\partial L}{\partial z'} \right) + \frac{d^2}{dx^2} \left(\lambda \frac{\partial L}{\partial z''} \right) - \dots = 0, \end{aligned} \right\} \\ L = 0,$$

which, with

give three equations to determine y, z and λ as functions of x .

1514. It will be observed that the terms after the first in the first and second of these equations, are those which accrue from the treatment of the term

$$\int \lambda \left(\delta L - \frac{dL}{dx} \delta x \right) dx$$

in the variaton of $\int \lambda L dx$, after the manner of Art. 1496.

We may note further that when L does not contain differential coefficients of y or z with respect to x , these equations reduce to $\bar{Y} + \lambda L_y = 0, \bar{Z} + \lambda L_z = 0, L = 0,$

and therefore give again the result of Art. 1511, viz.

$$\bar{Y}/L_y = \bar{Z}/L_z \quad \text{and} \quad L = 0.$$

1515. ILLUSTRATIVE EXAMPLES.

1. As an example of Case I. of Art. 1509, let us find the shortest distance from the surface $F(x, y, z) = 0$ to the surface $f(x, y, z) = 0$ without any further condition as to the path. This should obviously be a straight line cutting both surfaces perpendicularly.

We are to make $\int ds = \int \sqrt{1+y'^2+z'^2} dx$ a minimum, with specific terminal conditions. Here

$$V = \sqrt{1+y'^2+z'^2}, \quad X=0, \quad Y=0, \quad Y' = \frac{y'}{\sqrt{1+y'^2+z'^2}}, \quad Z=0, \\ Z' = \frac{z'}{\sqrt{1+y'^2+z'^2}}, \quad \bar{Y} = -\frac{d}{dx} Y, \quad \bar{Y}' = Y', \quad \bar{Z} = -\frac{d}{dx} Z, \quad \bar{Z}' = Z'.$$

The equations $\bar{Y}=0, \bar{Z}=0$ give

$$Y = C_1, \quad Z = C_2, \quad \text{i.e., } \frac{dy}{ds} = C_1, \quad \frac{dz}{ds} = C_2,$$

and therefore

$$\frac{dx}{ds} = \sqrt{1-C_1^2-C_2^2}.$$

That is, the tangent to the path is in a constant direction, and the path itself is a straight line.

At the terminals we have

$$[V \delta x + \bar{Y}(\delta y - y' \delta x) + \bar{Z}(\delta z - z' \delta x)] = 0, \quad \text{i.e. } \left[\frac{\delta x + y' \delta y + z' \delta z}{\sqrt{1+y'^2+z'^2}} \right] = 0,$$

and the variations at one end are independent of those at the other, i.e. $\delta x + y' \delta y + z' \delta z$ must be zero at each end, i.e.

$$\frac{dx}{ds} \delta x + \frac{dy}{ds} \delta y + \frac{dz}{ds} \delta z = 0$$

at each end. But the variations $\delta x, \delta y, \delta z$ must refer to displacements in the tangent planes of the terminal surfaces, for which

$$F_x \delta x + F_y \delta y + F_z \delta z = 0 \quad \text{and} \quad f_x \delta x + f_y \delta y + f_z \delta z = 0.$$

Hence the path sought must cut each surface orthogonally.

2. As an example of Case II. of Art. 1509, *examine by aid of these equations Lagrange's first rule*, Art. 1504, *where we have to find a function y such that* $\delta \int V dx = 0$ *under condition* $\int W dx = a$ *constant a.*

Putting $z = \int W dx$, we may write this as $L \equiv z' - W = 0$.

Then we make $\delta \int \{V + \lambda(z' - W)\} dx = 0$, λ being a function of x alone.

$$\text{We have } \bar{Y} + \frac{\partial}{\partial y} \lambda(z' - W) - \frac{d}{dx} \frac{\partial}{\partial y'} \lambda(z' - W) + \dots = 0 \left\{$$

$$\text{and } \bar{Z} + \frac{\partial}{\partial z} \lambda(z' - W) - \frac{d}{dx} \frac{\partial}{\partial z'} \lambda(z' - W) + \dots = 0. \left. \right\}$$

$$\text{But } \frac{\partial}{\partial y} \lambda(z' - W) = -\lambda \frac{\partial W}{\partial y}, \quad \frac{\partial}{\partial y'} \lambda(z' - W) = -\lambda \frac{\partial W}{\partial y'}, \quad \text{etc.}$$

$$\bar{Z} = 0, \quad \frac{\partial}{\partial z} \lambda(z' - W) = 0, \quad \frac{\partial}{\partial z'} \lambda(z' - W) = \lambda.$$

Hence these equations become

$$Y - Y' + Y'' - \dots - \left\{ \lambda \frac{\partial W}{\partial y} - \frac{d}{dx} \left(\lambda \frac{\partial W}{\partial y'} \right) + \dots \right\} = 0 \quad \text{and} \quad -\frac{d\lambda}{dx} = 0.$$

The second shows that λ does not contain x , and is a constant; and the first may then be written

$$Y - Y' + Y'' - \dots - \lambda \left(\frac{\partial W}{\partial y} - \frac{d}{dx} \frac{\partial W}{\partial y'} + \dots \right) = 0, \quad \text{i.e. } [\bar{Y}] = 0,$$

where $[\bar{Y}]$ refers to the operation

$$\left(\frac{\partial}{\partial y} - \frac{d}{dx} \frac{\partial}{\partial y'} + \frac{d^2}{dx^2} \frac{\partial}{\partial y''} - \dots \right)$$

upon $V - \lambda W$, regarding λ as a constant, which is the rule of Art. 1504.

3. Consider the stationary value of $\int_a^b \frac{x y dx}{y'}$. Comparison of the two cases. [Ohm. Todhunter, *Hist.*, p. 35.]

Let $z = \int_a^x y dx$. Then $z' = y$, $z'' = y'$. We may either

(i) consider $\int_a^b \frac{z}{z'} dx$ unconditionally,

or (ii) $\int_a^b \frac{z}{y'} dx$, with condition $z' - y = 0$.

(i) Here $V = \frac{z}{z''}$, $X = 0$, $Z = \frac{1}{z''}$, $Z_1 = 0$, $Z_{11} = -\frac{z}{z'^2}$.

The equation $V = \bar{Z}, z' + \bar{Z}_{11} z'' + C$ gives $V = (Z_1 - Z_{11})z' + Z_{11}z'' + C$, i.e.

$$2 \frac{z}{z''} = z' \frac{d}{dx} \left(\frac{z}{z'^2} \right) + C, \dots\dots\dots(1)$$

a first integral of the equation to find z as a function of x .

(ii) Or make $[\bar{Y}] = 0$, $[\bar{Z}] = 0$, with condition $L \equiv z' - y = 0$,

$$\frac{d}{dx} \left(\frac{z}{y'^2} \right) - \lambda = 0, \quad \frac{1}{y'} - \frac{d\lambda}{dx} = 0, \quad z' - y = 0.$$

Eliminating y and λ , we have

$$\frac{1}{z''} = \frac{d^2}{dx^2} \left(\frac{z}{z'^2} \right). \dots\dots\dots(2)$$

If (1) be differentiated to eliminate C , we find a result identical with (2), and equation (1) is a first integral of equation (2). The first method has therefore carried us one step onward in the integration, whilst the second has produced the original differential equation itself.

1516. If s (or t) denote the independent variable, and x, y, z , viz. the Cartesian or other coordinates, be the dependent variables, it will be desirable to alter our notation a little in conformity with such requirements.

We take the case of three dependent variables. It will make no difference in the investigation however many there may be. Accents will denote differentiations with regard to the independent variable.

Let
$$V = \phi \left(\begin{matrix} x, x', x'', \dots \\ s, y, y', y'', \dots \\ z, z', z'', \dots \end{matrix} \right),$$

and we shall write

$$\frac{\partial V}{\partial s} = S, \quad \frac{\partial V}{\partial x} = X, \quad \frac{d^r}{ds^r} \left(\frac{\partial V}{\partial x^{(n)}} \right) = X^{(r)}, \quad \frac{\partial^r}{\partial s^r} \left(\frac{\partial V}{\partial z^{(n)}} \right) = Z^{(r)}, \text{ etc.}$$

$$\xi^{(r)} = \delta x^{(r)} - x^{(r+1)} \delta s, \quad \eta^{(r)} = \delta y^{(r)} - y^{(r+1)} \delta s, \quad \zeta^{(r)} = \delta z^{(r)} - z^{(r+1)} \delta s,$$

$$\bar{X} = X - X' + X'' - \dots, \quad \bar{X}_r = X_r - X'_r + X''_r - \dots, \text{ etc.},$$

with similar meanings for \bar{Y}, \bar{Y}_r , etc., \bar{Z}, \bar{Z}_r , etc.

Then we have, to the first order,

$$\begin{aligned} \delta \int V ds &= [V \delta s + (\bar{X}_r \xi + \bar{X}_{r+1} \xi' + \dots) + (\bar{Y}_r \eta + \bar{Y}_{r+1} \eta' + \dots) \\ &\quad + (\bar{Z}_r \zeta + \bar{Z}_{r+1} \zeta' + \dots)] + \int (\bar{X}_r \xi + \bar{Y}_r \eta + \bar{Z}_r \zeta) ds \\ &\equiv [H] + \int (\bar{X}_r \xi + \bar{Y}_r \eta + \bar{Z}_r \zeta) ds, \text{ say, as in earlier cases.} \end{aligned}$$

1517. As before, if it be desired to discover the functional forms of x, y, z which will be required to give $\int V ds$ a stationary value, we have to make the above first order variation vanish.

There are two cases to consider, (i) when x, y, z are independent of each other; (ii) when some relation $L=0$, or some set of such relations exists between them.

1518. In Case (i), in the absence of any such relation, the arbitrary variations from point to point of the path, ξ, η, ζ , are independent of each other, and we have

$$X=0, \quad \bar{Y}=0, \quad \bar{Z}=0,$$

three differential equations, whose orders are, in general, double the order of the highest respective differential coefficients contained in V , and whose solutions severally contain the same number of arbitrary constants as their order. Secondly, there are as many equations arising from $[H]=0$, by equating to zero the *independent* terminal variations therein contained, as there are independent terminal variations.

Also, as in Art. 1500 (i), if V does not contain s explicitly, so that $S=0$, we have

$$V=(\bar{X},x'+\bar{X}_n,x''+\dots)+(\bar{Y},y'+\bar{Y}_n,y''+\dots) \\ +(\bar{Z},z'+\bar{Z}_n,z''+\dots)+C.$$

Other special cases may arise. For example, if

$$V=\phi(x, y, z, x', y', z'),$$

the independent variable being absent, we have

$$V=X.x'+Y.y'+Z.z'+C.$$

If $V=\phi(x', y', z', x'', y'', z'')$, we have

$$V=(X,-X_n)x'+X_nx''+(Y,-Y_n)y'+Y_ny'' \\ +(Z,-Z_n)z'+Z_nz''+C;$$

and also $X,-X_n=C_1$, $Y,-Y_n=C_2$, $Z,-Z_n=C_3$,

viz. the solutions of $\bar{X} \equiv -X'+X''=0$, etc.,

so that $V=C+C_1x'+C_2y'+C_3z'+X_nx''+Y_ny''+Z_nz''$;

and so on with other cases.

1519. In Case (ii), when there is a connecting equation $L=0$, we make $\delta \int (V+\lambda L) ds=0$, according to Lagrange's rule, and consider λ a function of s only.

$$\text{Then } \bar{X}+\lambda \frac{\partial L}{\partial x}-\frac{d}{ds}\left(\lambda \frac{\partial L}{\partial x'}\right)+\frac{d^2}{ds^2}\left(\lambda \frac{\partial L}{\partial x''}\right)-\dots=0,$$

which, with the two similar equations in y and z and the connecting equation $L=0$, give four equations from which x, y, z, λ are to be determined as functions of s .

When L contains only x, y and z , so that $L=0$ is the equation of a surface on which the path lies, these equations reduce to

$$\bar{X}+\lambda L_x=0, \quad \bar{Y}+\lambda L_y=0, \quad \bar{Z}+\lambda L_z=0,$$

$$\text{i.e. } \bar{X}/L_x=\bar{Y}/L_y=\bar{Z}/L_z, \text{ with } L=0.$$

These equations could be derived otherwise, as in Art. 1511; for we have

$$L_x\delta x+L_y\delta y+L_z\delta z=0 \quad \text{and} \quad L_x dx+L_y dy+L_z dz=0;$$

and, since $\xi=\delta x-x'\delta s$, $\eta=\delta y-y'\delta s$, $\zeta=\delta z-z'\delta s$,

$$\text{we get } L_x\xi+L_y\eta+L_z\zeta=0,$$

an equation which constitutes a linear relation amongst the otherwise arbitrary variations ξ, η, ζ , which involve the four variations $\delta s, \delta x, \delta y, \delta z$.

We also have $\bar{X}\xi + \bar{Y}\eta + \bar{Z}\zeta = 0$. Let one of these variations be taken such that $\xi = 0$, then $\bar{X}/L_x = \bar{Y}/L_y$. Similarly taking another variation in which $\eta = 0$, then $\bar{X}/L_x = \bar{Z}/L_z$. Thus we get

$$\bar{X}/L_x = \bar{Y}/L_y = \bar{Z}/L_z, \text{ with } L=0, \text{ as before.}$$

1520. When z and its differential coefficients are absent from V and L , we obtain over again the relations of Art. 1511, viz. $\bar{X}/L_x = \bar{Y}/L_y$ and $L=0$.

1521. In any case, where we are to make $\int V ds$ a maximum or a minimum and s is an arc of the path and x, y, z , Cartesian coordinates of a point upon it, we have the relation

$$L \equiv x^2 + y'^2 + z'^2 - 1 = 0,$$

and we may make $\int \left\{ V + \frac{\lambda}{2}(x^2 + y'^2 + z'^2 - 1) \right\} ds$ an unconditional maximum or minimum. Here $\frac{1}{2}\lambda$ has been written instead of λ for later convenience. If V be a function of x, y, z alone, not containing s explicitly, we have

$$S = \frac{1}{2} \frac{d\lambda}{ds} (x^2 + y'^2 + z'^2 - 1), \quad [X] = \frac{\partial V}{\partial x}, \quad [Y] = \frac{\partial V}{\partial y}, \quad [Z] = \frac{\partial V}{\partial z},$$

$$[X.] = \lambda x', \quad [Y.] = \lambda y', \quad [Z.] = \lambda z', \quad [\bar{X}] = \frac{\partial V}{\partial x} - \frac{d}{ds}(\lambda x'),$$

$$[\bar{Y}] = \text{etc.}, \quad [\bar{Z}] = \text{etc.},$$

and $[V] = [X.]x' + [Y.]y' + [Z.]z' + C,$

i.e. $V + \frac{\lambda}{2}(x^2 + y'^2 + z'^2 - 1) = \lambda(x^2 + y'^2 + z'^2) + C,$

i.e. $V = \lambda + C. \dots\dots\dots(1)$

1522. Again the terminal equations give

$$[[V]\delta s + [\bar{X}.]\xi + [\bar{Y}.]\eta + [\bar{Z}.]\zeta] = 0,$$

i.e. $\left[\left\{ V + \frac{\lambda}{2}(x^2 + y'^2 + z'^2 - 1) \right\} \delta s + \lambda x'(\delta x - x' \delta s) + \lambda y'(\delta y - y' \delta s) + \lambda z'(\delta z - z' \delta s) \right] = 0,$

or $[(V - \lambda) \delta s + \lambda(x' \delta x + y' \delta y + z' \delta z)] = 0,$

or $[C \delta s + \lambda(x' \delta x + y' \delta y + z' \delta z)] = 0,$

i.e. $C(\delta s_1 - \delta s_0) + \left[\lambda(x' \delta x + y' \delta y + z' \delta z) \right]_0^1 = 0,$

and therefore $C(\delta s_1 - \delta s_0) = 0$ and $\left[\lambda(x' \delta x + y' \delta y + z' \delta z) \right]_0^1 = 0$, for the terminal variations of s are independent of the terminal variations of x, y, z .

In isoperimetric problems, *i.e.* those concerned with an arc of specific length, $\delta s_1 - \delta s_0$ vanishes; but in other cases δs_1 and δs_0 are not necessarily equal, and then $C = 0$. Thus, for isoperimetric cases, $V = \lambda + C$, and the value of C is to be determined by the length of the arc; for non-isoperimetric cases with an undefined length of arc $C = 0$ and $V = \lambda$.

In either case, provided λ be not such as to vanish at either terminal, we must have $x' \delta x + y' \delta y + z' \delta z = 0$ at each terminal. That is, if the terminals are to be on specific terminal curves the path must cut each orthogonally. But if the terminals be fixed points this expression will vanish identically by virtue of the vanishing of $\delta x, \delta y, \delta z$.

Since in non-isometric problems $V = \lambda$, we may write

$$\int \left[V + \frac{\lambda}{2}(x'^2 + y'^2 + z'^2 - 1) \right] ds \quad \text{as} \quad \frac{1}{2} \int V(x'^2 + y'^2 + z'^2 + 1) ds$$

at once. (See Williamson, *I.C.*, Art. 296.)

1523. If V be any function of x, y, z alone, and $\int V ds$ is to be made of stationary value for curves to be discovered lying upon a given surface $\phi(x, y, z) = 0$, and with fixed terminals or fixed terminal curves, we have $\delta \int V ds = 0$, and we may treat the variation *ab initio* as follows.

$$\text{We have } \int (\delta V ds + V d \delta s) = 0.$$

But $\delta V = V_x \delta x + V_y \delta y + V_z \delta z$, and $d \delta s = x' d \delta x + y' d \delta y + z' d \delta z$, so that

$$\begin{aligned} \delta \int V ds &= \int \{ (V_x \delta x + V_y \delta y + V_z \delta z) ds + V(x' d \delta x + y' d \delta y + z' d \delta z) \} \\ &= [V(x' \delta x + y' \delta y + z' \delta z)] \\ &+ \int \left\{ \left(V_x - \frac{d}{ds} V x' \right) \delta x + \left(V_y - \frac{d}{ds} V y' \right) \delta y + \left(V_z - \frac{d}{ds} V z' \right) \delta z \right\} ds. \end{aligned}$$

So that we must have $[V(x'\delta x + y'\delta y + z'\delta z)] = 0$, as the terminal condition and

$$\left(V_x - \frac{d}{ds} Vx'\right)\delta x + \left(V_y - \frac{d}{ds} Vy'\right)\delta y + \left(V_z - \frac{d}{ds} Vz'\right)\delta z = 0$$

along the path.

We also have $\phi_x \delta x + \phi_y \delta y + \phi_z \delta z = 0$, a linear connection between the otherwise arbitrary point to point variations $\delta x, \delta y, \delta z$. Hence

$$\begin{aligned} \left(V_x - \frac{d}{ds} Vx' - \lambda \phi_x\right)\delta x + \left(V_y - \frac{d}{ds} Vy' - \lambda \phi_y\right)\delta y \\ + \left(V_z - \frac{d}{ds} Vz' - \lambda \phi_z\right)\delta z = 0. \end{aligned}$$

Now, two of the variations are arbitrary, and λ is at our choice.

Take $\delta z = 0$, and choose δx not equal to 0 and $\lambda = \frac{V_y - \frac{d}{ds} Vy'}{\phi_y}$.

Then it follows that $V_x - \frac{d}{ds} Vx' - \lambda \phi_x = 0$; and similarly we may show, by taking $\delta x = 0$, that $V_z - \frac{d}{ds} Vz' - \lambda \phi_z = 0$.

$$\text{Thus } \frac{V_x - \frac{d}{ds}(Vx')}{\phi_x} = \frac{V_y - \frac{d}{ds}(Vy')}{\phi_y} = \frac{V_z - \frac{d}{ds}(Vz')}{\phi_z}.$$

The terminal condition $[V(x'\delta x + y'\delta y + z'\delta z)] = 0$ shows that, provided V be not zero at the terminals, the path must cut each of the terminal curves orthogonally.

IMPORTANT APPLICATIONS.

1524. GEODESICS.

To find the shortest line, or geodesic, on a given surface $\phi(x, y, z) = 0$, from one given terminal curve to another drawn upon the surface.

Here $u = \int ds$, i.e. $V = \sqrt{x'^2 + y'^2 + z'^2}$.

Then $X = 0, \quad X_1 = \frac{x'}{\sqrt{x'^2 + y'^2 + z'^2}},$

$$\bar{X} = X - \frac{d}{ds} X_1 = -\frac{d}{ds} x' = -x'', \quad \bar{Y} = -y'', \quad \bar{Z} = -z''.$$

Thus, by Art. 1519, $x''/\phi_x = y''/\phi_y = z''/\phi_z$, *i.e.* the osculating plane at each point of the curve must contain the normal to the surface at that point.

The terminal condition is $[V\delta s + \bar{X}\xi + \bar{Y}\eta + \bar{Z}\zeta] = 0$,

$$\text{i.e.} \quad [\delta s + x'(\delta x - x'\delta s) + y'(\delta y - y'\delta s) + z'(\delta z - z'\delta s)] = 0,$$

$$\text{i.e.} \quad [x'\delta x + y'\delta y + z'\delta z] = 0.$$

Now fix one end, then $x'\delta x + y'\delta y + z'\delta z = 0$ at the other end, so that the line sought must cut the terminal curve at that end orthogonally. Similarly for the other end of the path. Thus the path must be such that

- (1) the osculating plane at each point contains the normal to the surface at that point ;
- (2) it must cut both terminal curves orthogonally.

1525. We might, without quoting the general theorem of Art. 1519, proceed as follows, a course which is usually preferable.

Since we are to make $\delta \int \sqrt{dx^2 + dy^2 + dz^2} = 0$, we have

$$\int \frac{dx d\delta x + dy d\delta y + dz d\delta z}{ds} = 0 ;$$

$$\therefore [x'\delta x + y'\delta y + z'\delta z] - \int (x''\delta x + y''\delta y + z''\delta z) ds = 0 ;$$

and along the path we have

$$x''\delta x + y''\delta y + z''\delta z = 0, \text{ with condition } \phi_x\delta x + \phi_y\delta y + \phi_z\delta z = 0,$$

$$\text{i.e.} \quad (x'' - \lambda\phi_x)\delta x + (y'' - \lambda\phi_y)\delta y + (z'' - \lambda\phi_z)\delta z = 0.$$

Now of the three δx , δy , δz , two are independent, say δy and δz .

Let $\delta z = 0$, and take $\delta y \neq 0$; λ is at our choice ; take it = x''/ϕ_x . Then $y'' = \lambda\phi_y$. Thus $x''/\phi_x = y''/\phi_y$, and similarly = z''/ϕ_z .

We also have the terminal condition $x'\delta x + y'\delta y + z'\delta z = 0$ at each end, and the path cuts the terminal curves orthogonally.

1526. Geodesic on a Surface of Revolution.

Let the surface be, say, $x^2 + y^2 = f(z)$, the z -axis being the axis of revolution. Then $x''/x = y''/y$, *i.e.* $xy'' - yx'' = 0$, or $xy' - yx' = \text{const.} = h$, say. Referring to cylindrical coordinates (ρ, ϕ, z) , $\rho^2\phi' = h$, *i.e.* $\rho \sin \chi = h$, where χ is the angle between the path and a meridian at any point of the curve. This is the leading property of such geodesics.

1527. Geodesics on a Quadric.

For geodesics upon an ellipsoid we have the relation $pd = \text{const.}$, where p is the perpendicular on the tangent plane

to the ellipsoid at any point on the curve and d is the semi-diameter parallel to the tangent to the curve at that point. For proof of this and for the general properties of geodesics on a quadric, see Smith, *Solid Geom.*, ch. xii.

1528. *Required the nature of the projection upon the z -plane of geodesics upon the helicoidal surface $z = a \tan^{-1} y/x$.*

Here $\phi = x \sin z/a - y \cos z/a = 0$, $\phi_x = \sin z/a$, $\phi_y = -\cos z/a$.

The geodesic equations give $x''/\sin \frac{z}{a} = y''/\left(-\cos \frac{z}{a}\right)$, i.e. $xx'' + yy'' = 0$; changing to cylindricals $x = \rho \cos \theta$, $y = \rho \sin \theta$, $z = a\theta$, $ds^2 = d\rho^2 + \rho^2 d\theta^2 + dz^2$. Then indicating differentiations with regard to θ by suffixes, and those with regard to s by accents, $s_1^2 = \rho_1^2 + \rho'^2 + a^2$, i.e. $s_1 s_2 = \rho_1 \rho_2 + \rho \rho_1$.

Now $\rho^2 = x^2 + y^2$, $\rho \rho' = xx' + yy'$.

Hence $\rho \rho'' + \rho'^2 = xx'' + yy'' + x'^2 + y'^2 = x'^2 + y'^2 = \rho'^2 + \rho^2 \theta'^2$;

$\therefore \rho \rho'' = \rho^2 \theta'^2$ and $\frac{d^2 \rho}{ds^2} \cdot \left(\frac{ds}{d\theta}\right)^2 = \rho$, i.e. $\frac{d}{d\theta} \left(\frac{d\rho}{ds}\right) = \frac{\rho}{s_1}$ or $\frac{d}{d\theta} \left(\frac{\rho_1}{s_1}\right) = \frac{\rho}{s_1}$;

whence $(\rho_2 s_1 - \rho_1 s_2)/s_1^2 = \rho/s_1$, i.e. $\rho_2 s_1^2 - \rho_1 s_1 s_2 = \rho s_1^2$,
i.e. $(\rho_2 - \rho)(\rho_1^2 + \rho'^2 + a^2) = \rho_1(\rho_1 \rho_2 + \rho \rho_1)$ or $\rho_2(\rho^2 + a^2) - 2\rho \rho_1^2 = \rho(\rho^2 + a^2)$.

Let $\rho = a \cot \chi$, then $\rho_1 = -a \operatorname{cosec}^2 \chi \frac{d\chi}{d\theta}$; $\therefore \frac{d}{d\theta} \left(\frac{d\chi}{d\theta}\right) = -\sin \chi \cos \chi$;

$\therefore \left(\frac{d\chi}{d\theta}\right)^2 = -\sin^2 \chi + \frac{1}{k^2}$, where $\frac{1}{k^2}$ is a constant > 1 ;

$\therefore \frac{d\theta}{k} = \frac{d\chi}{\sqrt{1 - k^2 \sin^2 \chi}}$ and $\chi = \operatorname{am} \left(\frac{\theta}{k} + a\right)$, where a is a second arbitrary constant. Hence the projection of the geodesics on the z -plane has an equation of the form $r = a \operatorname{ctn} \left(\frac{\theta}{k} + a\right)$, mod. k , k and a being constants depending upon the position of the terminals.

The reader will have no difficulty in showing that if ϕ be the angle which the tangent at any point of the geodesic makes with the generator at this point, and ψ the angle the normal to the surface makes with the axis of the helicoid, then $\sin \phi = k \sin \psi$; and hence that if $A_1 A_2 A_3 \dots$ be any closed geodesic polygon drawn upon the surface, and ϕ_r, ϕ_r' be the angles which $A_r A_{r-1}, A_r A_{r+1}$ make with the generator through A_r , then $\Pi \sin \phi_r = \Pi \sin \phi_r'$.

1529. *Suppose we are to obtain the stationary value of*

$$\int \sqrt{E + 2Fy' + Gy'^2} dx,$$

where E, F, G are known functions of the variables x and y .

Here $Y = \frac{E_y + 2F_y y' + G_y y'^2}{2V}$, $Y_1 = \frac{F + Gy'}{V}$,

where suffixes denote partial differentiations.

The differential equation to be satisfied is $\ddot{Y} \equiv Y - Y' = 0$,

i.e.
$$\frac{E_y + 2F_y y' + G_y y'^2}{2V} = \frac{d}{dx} \frac{F + G y'}{V}.$$

After differentiation and considerable reduction, this leads to an equation

$$A + B y' + C y'^2 + D y'^3 + 2(F^2 - EG) y'' = 0, \dots\dots\dots(1)$$

where $A = EE_y - 2FF_x + FE_x$, $B = 3FE_y - 2EG_x - 2FF_x + GE_x$,

$$C = -3FG_x + 2GE_y + 2FF_y - EG_y, \quad D = -GG_x + 2GF_y - FG_y,$$

for the terms in $y^4, y'y'', y'^2 y''$ all cancel out.

The equation (1) is incapable of *general* solution, but many cases arise in which at least a first integration may be effected, and sometimes the complete integration.

1530. (i) For instance, if E, F and G be constants, $A = B = C = D = 0$, and the solution is that of $y'' = 0$, i.e. a straight line.

(ii) If $E = G = L - M$ where L is a function of x alone and M a function of y alone, and if $F = 0$,

$$A = (L - M)(-M_y), \quad B = -(L - M)L_x,$$

$$C = (L - M)(-M_y), \quad D = -(L - M)L_x,$$

and equation (1) becomes

$$2(L - M)y'' + (1 + y'^2)(M_y + y'L_x) = 0$$

or
$$\frac{2y'y''}{1 + y'^2} - \frac{L_x - M_y y'}{L - M} + \frac{L_x(1 + y'^2)}{L - M} = 0,$$

i.e.
$$\frac{d}{dx} [\log(1 + y'^2) - \log(L - M)] + L_x \frac{1 + y'^2}{L - M} = 0;$$

or putting $\frac{1 + y'^2}{L - M} = z$, $\frac{1}{z} \frac{d}{dx} \log z + L_x = 0$, whence $\frac{1}{z^2} \frac{dz}{dx} + L_x = 0$.

Hence a first integral is $\frac{L - M}{1 + y'^2} - L = -\lambda$, i.e. $y'^2 = \frac{M - \lambda}{\lambda - L}$,

i.e.
$$\int \frac{dx}{\sqrt{\lambda - L}} = \int \frac{dy}{\sqrt{M - \lambda}} + \text{const.},$$
 a second integral,

for by supposition L is a function of x alone and M a function of y alone, so that the variables are "separable" in such cases.

1531. The case of Art. 1529 is an important one, for it will be remembered that if the coordinates of a point upon a surface be expressed in terms of two parameters u and v , the element of arc may be expressed in the form $ds^2 = E du^2 + 2F du dv + G dv^2$.

Hence the determination of a geodesic upon the surface depends upon the possibility of integrating the differential equation (1).

1532. The direct investigation of the geodesic may be sometimes effected by a transformation. For example, if the square of the linear element on a surface be given by $ds^2 = \frac{(1-v^2)du^2 + (1-u^2)dv^2 + 2uv\,du\,dv}{1-u^2-v^2}$, let us take a third variable w such that $u^2 + v^2 + w^2 = 1$, whence

$$u\,du + v\,dv + w\,dw = 0.$$

$$\begin{aligned} \text{Then } ds^2 &= \{(u^2 + w^2)du^2 + (v^2 + w^2)dv^2 + 2uv\,du\,dv\}/w^2 \\ &= \{(u\,du + v\,dv)^2 + w^2(du^2 + dv^2)\}/w^2 = du^2 + dv^2 + dw^2, \end{aligned}$$

so $s = \int \sqrt{du^2 + dv^2 + dw^2}$, with condition $u^2 + v^2 + w^2 = 1$.

That is, the arc of the curve on the original surface is the same length as the corresponding arc of a corresponding curve on the unit sphere in a system of rectangular coordinates u, v, w . And the geodesics on the sphere are given by the great circles, i.e. by equations of the form $au + bv + cw + 0$; hence the geodesics on the original surface are given by $au + bv + c\sqrt{1 - u^2 - v^2} = 0$, where a, b, c are constants.

1533. Principle of Least Action.

Suppose a particle of mass m to be in motion under the action of any conservative system of forces and either to be moving freely or under compulsion to remain on a smooth surface from any one point to any other point. Then, if v be the velocity at any time t , and ds an element of the path, we shall show that the integral $m \int v\,ds$ has a stationary value.

The quantity A defined as $m \int v\,ds$ is called the Action, or the Characteristic Function, by Sir W. R. Hamilton, and the principle is known as the Principle of Least Action.

1534. If X, Y, Z be the force components per unit mass, R the normal pressure exerted by the surface, if any pressure exist, and λ, μ, ν the direction cosines of the normal, the ordinary equations of motion are

$$\ddot{x} = X + R\lambda, \quad \ddot{y} = Y + R\mu, \quad \ddot{z} = Z + R\nu,$$

and the energy equation is

$$m \frac{v^2}{2} = m \int (X\,dx + Y\,dy + Z\,dz) = m\chi(x, y, z) \text{ say,}$$

for the expression $X\,dx + Y\,dy + Z\,dz$ satisfies the condition of integrability, since the forces form a conservative system, i.e. are such as occur in nature.

Hence, we have $v\,\delta v = X\,\delta x + Y\,\delta y + Z\,\delta z$.

But we also have $ds^2 = dx^2 + dy^2 + dz^2$, so that $s d\delta s = \dot{x} d\delta x + \dot{y} d\delta y + \dot{z} d\delta z$, and the variation in A , i.e. $\delta A = m \delta \int v ds = m \int (\delta v ds + v d\delta s)$

$$\begin{aligned} &= m \int \{ (X \delta x + Y \delta y + Z \delta z) dt + \dot{x} d\delta x + \dot{y} d\delta y + \dot{z} d\delta z \} \\ &= m [\dot{x} \delta x + \dot{y} \delta y + \dot{z} \delta z] + m \int \{ (X - \dot{x}) \delta x + (Y - \dot{y}) \delta y + (Z - \dot{z}) \delta z \} dt \\ &= m [\dot{x} \delta x + \dot{y} \delta y + \dot{z} \delta z] - m \int R(\lambda \delta x + \mu \delta y + \nu \delta z) dt, \end{aligned}$$

and since the direction defined by λ, μ, ν , i.e. the normal to the surface, is necessarily perpendicular to any displacement $\delta x, \delta y, \delta z$ on the surface, $\lambda \delta x + \mu \delta y + \nu \delta z$ vanishes, as also does each of the terminal values of $\dot{x} \delta x + \dot{y} \delta y + \dot{z} \delta z$.

So that the variation of A is zero and the "action" has a stationary value. Conversely, if we assume that if $\int v ds$ has a stationary value, we can establish the general equations of motion of the particle.

1535. It follows of course that if X, Y, Z be all zero, i.e. if the particle be in motion on a smooth surface under the action of no forces except those due to the constraint of the surface, then v is constant, as shown by the energy equation, and $\int v ds$ being of stationary value, so also is $\int ds$. That is, the particle searches out for itself and travels along a geodesic on the surface. (See Tait and Steele, *Dyn. of a Particle*, Art. 233, also Routh, *Dyn. of a Particle*.)

1536. Path of a Ray of Light in a Heterogeneous Medium.

When a ray of light travels in a medium of variable refractive index μ from one point to another, it does so in such a manner as to make $\int \mu ds$ a minimum. It is required to deduce the equations of the path of the ray.

This case is similar to the one just discussed.

$$\text{We have} \quad \delta \int \mu ds = 0, \quad \text{i.e.} \quad \int (\delta \mu ds + \mu d\delta s) = 0,$$

$$\text{and} \quad ds d\delta s = dx d\delta x + dy d\delta y + dz d\delta z;$$

$$\therefore \int \{ \delta \mu ds + \mu (x' d\delta x + y' d\delta y + z' d\delta z) \} = 0,$$

$$\text{and} \quad \delta \mu = \mu_x \delta x + \mu_y \delta y + \mu_z \delta z.$$

$$\text{Hence} \quad [\mu_x' \delta x + \mu_y' \delta y + \mu_z' \delta z]$$

$$+ \int \left[\left\{ \mu_x - \frac{d}{ds} \left(\mu \frac{dx}{ds} \right) \right\} \delta x + \left\{ \mu_y - \frac{d}{ds} \left(\mu \frac{dy}{ds} \right) \right\} \delta y + \left\{ \mu_z - \frac{d}{ds} \left(\mu \frac{dz}{ds} \right) \right\} \delta z \right] ds = 0;$$

and since the ray is to pass from one definite point to another, the integrated portion vanishes at each terminal, and the variations δx ,

δy , δz under the integral sign being arbitrary from point to point, we must have also

$$\frac{\partial \mu}{\partial x} = \frac{d}{ds} \left(\mu \frac{dx}{ds} \right), \quad \frac{\partial \mu}{\partial y} = \frac{d}{ds} \left(\mu \frac{dy}{ds} \right), \quad \frac{\partial \mu}{\partial z} = \frac{d}{ds} \left(\mu \frac{dz}{ds} \right),$$

which form the differential equations of the path of the ray.

1537. Brachistochronism. The General Problem.

A particle is in motion under the action of a given conservative system of forces. It is required to find the path along which it must be constrained to move so as to accomplish that path from one given point to another, or from one given surface to another, in the shortest time. Such constrained paths are called Brachistochrones. The case of brachistochronism under the action of gravity has already been considered.

Let $m\phi(x, y, z)$ be the potential energy of the force system, m being the mass of the particle.

Then the energy equation gives $\frac{1}{2}v^2 + \phi(x, y, z) = \text{const.}$

The force-components per unit mass are $-\phi_x$, $-\phi_y$, $-\phi_z$, being the rates of decrease of potential energy. By varying v , we have

$$v \delta v + \phi_x \delta x + \phi_y \delta y + \phi_z \delta z = 0.$$

Also $ds d\delta s = dx d\delta x + dy d\delta y + dz d\delta z$, i.e. $d\delta s = x' d\delta x + y' d\delta y + z' d\delta z$.

Now we are to make $t \equiv \int \frac{ds}{v}$ a minimum.

$$\text{So} \quad \delta t = \delta \int \frac{ds}{v} = \int \left(\frac{d\delta s}{v} - \frac{1}{v^2} ds \delta v \right) = 0.$$

$$\text{Therefore} \quad \int \left\{ \frac{1}{v} (x' d\delta x + \dots) \right\} + \int \left\{ \frac{1}{v^3} (\phi_x \delta x + \dots) \right\} ds = 0,$$

$$\text{i.e.} \quad \left[\frac{x' \delta x + \dots}{v} \right] + \int \left[\left\{ \frac{\phi_x}{v^3} - \frac{d}{ds} \left(\frac{x'}{v} \right) \right\} \delta x + \dots \right] ds = 0,$$

and δx , δy , δz are arbitrary all along the path and independent of each other, and of the variations at the terminals. Hence

$$\left[\frac{x' \delta x + y' \delta y + z' \delta z}{v} \right] = 0 \quad \text{and} \quad \frac{d}{ds} \left(\frac{x'}{v} \right) = \frac{\phi_x}{v^3}, \quad \frac{d}{ds} \left(\frac{y'}{v} \right) = \frac{\phi_y}{v^3}, \quad \frac{d}{ds} \left(\frac{z'}{v} \right) = \frac{\phi_z}{v^3}.$$

1538. The Terminal Conditions.

If the terminals be fixed points, the expression in square brackets vanishes identically at each end of the path.

If the path start from a fixed point (x_0, y_0, z_0) and terminate at the surface $F(x, y, z) = 0$, then δx , δy , δz vanish at the starting point, and provided the velocity be not infinite at the other terminal $x' \delta x + y' \delta y + z' \delta z$ must vanish there; that is, the path must cut the surface $F(x, y, z) = 0$ orthogonally, for the only admissible variations δx , δy , δz at this end are such as lie on the surface.

If the path start from a point x_0, y_0, z_0 , which is only defined as lying upon a surface $F_0(x, y, z) = 0$, a similar result will hold, provided that the whole energy of the system be a given quantity, and that $F_0 = 0$ be an

equipotential surface of the force system. If the surface $F_0=0$ were not an equipotential surface, terms depending on $\delta x_0, \delta y_0, \delta z_0$ would make their appearance in the integral, and such terms if existent would have to be included with the rest of the terminal terms.

If the motion terminate at a given curve instead of at a given surface, the terminal conditions may be discussed in a similar manner.

1539. The Normal Pressure in the Case of Brachistochronous Description.

From the general equations $\frac{d}{ds}\left(\frac{1}{v}\frac{dx}{ds}\right)=\frac{\phi_x}{v^3}$, etc., which may be written

$$v^2x'' - vv'x' - \phi_x = 0, \text{ etc.},$$

we have, by eliminating v^2 and vv' ,

$$\begin{vmatrix} x'' & x' & \phi_x \\ y'' & y' & \phi_y \\ z'' & z' & \phi_z \end{vmatrix} = 0,$$

so that the resultant force at any point lies in the osculating plane of the curve.

Moreover, multiplying the equations $v^2x'' - vv'x' - \phi_x = 0$, etc., by $\rho x'', \rho y'', \rho z''$ respectively, ρ being the radius of absolute curvature, we have by addition $v^2/\rho = \phi_x \rho x'' + \phi_y \rho y'' + \phi_z \rho z'' = -N$, where N is the normal force component.

If, however, R be the pressure per unit mass upon the curve, the normal resolution gives the equation $v^2/\rho = N + R$.

Hence $R = -2N$. That is, the pressure upon the curve is equal to twice the normal component of the forces, and acts in the opposite direction.

Now for a free path under a conservative system of forces for which the components in the direction of the tangent and principal normal are T and N' , there being no component in the direction of the binormal, we have $\frac{v}{ds}dv = T$ and $\frac{v^2}{\rho} = N'$, whilst for the same path to be brachistochronous under frictionless constraint under the action of a corresponding set of forces whose components are $T, N, 0$, we have $\frac{v}{ds}dv = T$ and $\frac{v^2}{\rho} = -N$ (i.e. $= N + R$ where $R = -2N$).

1540. Hence we have Townsend's theorem: "If for the same velocity of description any curve, plane or twisted, be at once a free path for one conservative system of forces and a brachistochronous path under frictionless constraint for another conservative system of forces, the resultants of the two force systems must at every point of the curve be reflexions of each other as regards both magnitude and direction with respect to the current tangent at the point."

1541. The principal cases are:

- (a) When the motion is under a single force in a given direction.
- (b) When the force tends to or from a fixed point.

1542. Case (a). Force in a Given Direction.

Take the y -axis parallel to this direction. Let m be the mass of the particle, $mF(y)$ the potential energy. The force to increase y , being the rate of decrease of potential energy, is $-mF'(y)$. The pressure on the curve is $R \equiv 2mF'(y) \cos \psi$, ψ being the inclination of the tangent to the x -axis.

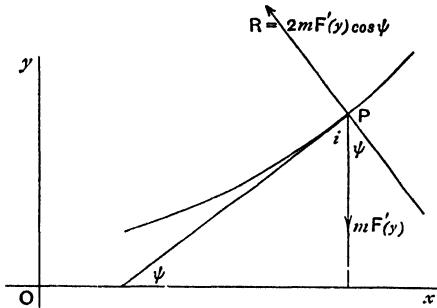

Fig. 447.

Let $y = a$ be the line of zero velocity; then we have $\frac{1}{2}v^2 + F(y) = F(a)$, and $v^2/\rho = F'(y) \cos \psi$.

Hence
$$\frac{v^2}{\rho \cos \psi} = F'(y) = -\frac{v dv}{dy},$$

i.e.
$$\frac{1}{v} \frac{dv}{ds} = -\frac{dy}{ds} \cdot \frac{1}{\rho \cos \psi} = -\tan \psi \frac{d\psi}{ds},$$

whence $v = u \cos \psi$, where u is the value of v when $\psi = 0$.

Also the y - ψ equation of the brachistochrone is $\frac{1}{2} u^2 \cos^2 \psi = F(a) - F(y)$. It is convenient to use the angle i , the angle between the ordinate and the current tangent, in place of ψ , and $i = \frac{\pi}{2} - \psi$.

Then the law of force necessary for brachistochronism is given by $P \equiv \frac{u^2}{2} \frac{d}{dy} (\sin^2 i)$, per unit mass, repulsive from the x -axis, with a line of zero velocity found by the vanishing of i . Also the pressure upon the curve is $R = 2mF'(y) \cos \psi = -2mP \cos \psi$ towards the centre of curvature.

1543. Case (b). Central Force.

Take the origin at the centre of force. Let $mF(r)$ be the potential energy. The radial force from the origin is $-mF'(r)$ and $R = 2mF'(r) \sin \phi$, where ϕ is the angle between the tangent and the radius vector. Let a be the radius of the circle of zero velocity.

Then
$$\frac{1}{2}v^2 + F(r) = F(a) \quad \text{and} \quad v^2/\rho = -F'(r) \sin \phi.$$

Hence
$$\frac{v^2}{\rho \sin \phi} = -F'(r) = \frac{v dv}{dr}; \quad \text{i.e.} \quad \frac{1}{v} \frac{dv}{dr} = \frac{dp}{r dr} \cdot \frac{r}{p} = \frac{1}{p} \frac{dp}{dr}.$$

Therefore $v/p = \text{const.} = h$, say. Whence the pedal equation of the brachistochrone is $\frac{1}{2}h^2 p^2 + F(r) = F(a)$, and the law of force is $P = \frac{h^2}{2} \frac{dp^2}{dr}$, repulsive from the origin, with a circle of zero velocity whose radius is to be obtained by the vanishing of p .

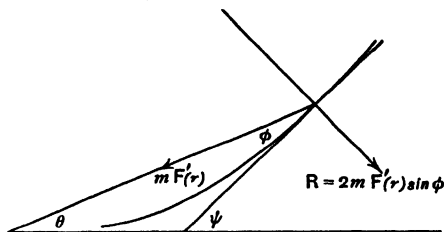

Fig. 448.

The pressure on the curve towards the centre of curvature is

$$-2mF'(r) \sin \phi = 2mP \sin \phi = 2mP \frac{p}{r}.$$

1544. Comparison of Analogous Results.

It is worth while for the student to note that

(a) For parallel forces :

(i) for a free path $\int v ds = \text{min.}, \quad v \cos \psi = u \text{ (a constant) ;}$

(ii) for brachistochrone $\int \frac{ds}{v} = \text{min.}, \quad v/\cos \psi = u.$

(b) For central forces :

(i) for free path $\int v ds = \text{min.}, \quad vp = h \text{ (constant) ;}$

(ii) for brachistochrone $\int \frac{ds}{v} = \text{min.}, \quad v/p = h.$

Compare the following laws of central force for various circumstances :

(a) Particle in free motion $P = \frac{h^2}{p^3} \frac{dp}{dr}, \quad pv = h.$

(b) Particle in brachistochronous motion $P = h^2 p \frac{dp}{dr}, \quad v/p = h.$

(c) Equilibrium of inextensible string $P = \frac{h}{p^2} \frac{dp}{dr}, \quad Tp = h.$

(d) Equilibrium of extensible string $P = \frac{h}{p^3} \frac{dp}{dr} + \lambda \frac{h^2}{p^3} \frac{dp}{dr}, \quad Tp = h.$

1545. Energy Condition for an Equilibrating System.

If V be the potential energy of a field of force in which any system of material particles has assumed a position of equilibrium, it is known that the configurations of stability and instability are those of minimum or maximum values of V .

Cases in which a stationary value of V occurs without a true maximum or minimum give neutral equilibrium, in which there may be stability

for some displacements, instability for others. The Calculus of Variations supplies a very powerful instrument for the discussion of such problems.

1546. Ex. *An inelastic string of uniform density and length l is attached to two fixed points A and B . Find the condition that it disposes itself in a curve of specified shape under the action of a central force in a field of potential V .*

Let m be the mass per unit length. Then the potential energy of the whole string is $\int mV ds$, and for stability we are to make $\int (V + \lambda) ds$ a minimum, V being a function of r alone. Then, with the usual notation of polars,

$$\delta \int (V + \lambda) \sqrt{r^2 + r'^2} d\theta = 0;$$

$$\therefore (V + \lambda) \sqrt{r^2 + r'^2} = (V + \lambda) \frac{r'^2}{\sqrt{r^2 + r'^2}} + C \quad \text{or} \quad \frac{V + \lambda}{\sqrt{r^2 + r'^2}} = \frac{C}{r^2}.$$

Hence
$$V + \lambda = \frac{C ds}{r^2 d\theta} = \frac{C}{r \sin \phi},$$

ϕ being the angle between the tangent and the radius vector, i.e.

$$V + \lambda = \frac{C}{p}, \dots\dots\dots(1)$$

C being a constant.

This gives the law of potential of the field of force.

Thus P (viz. the repulsive force from the pole) = $-\frac{dV}{dr} = \frac{C dp}{p^2 dr}$(2)

V being supposed a known function of r , we now have a relation from (1) in terms of r, θ, λ, C , and another constant which will be introduced when we have integrated equation (1) to get that relation into the r, θ form. Two of the equations to determine the three constants will be obtained by making the curve pass through the terminal points; the other is provided by making

$$\int_A^B \sqrt{r^2 + r'^2} d\theta = l.$$

If T be the tension, a resolution along the normal gives

$$\frac{T ds}{\rho} = P ds \sin \phi = P ds \cdot \frac{p}{r},$$

i.e.

$$Tp = P \cdot \frac{p^2 r dr}{dp} = C, \quad \text{i.e. } T = V + \lambda.$$

That Tp is constant is also obvious by taking moments about the centre of force for any portion of the string. (See Art. 1544.)

Taking the more general case of a string of length l , attached to two given points A, B , and of variable line-density ρ , which is a function of s , the arcual distance of any point from A , and constrained to lie upon a given smooth surface $f(x, y, z) = 0$, and in a field of force of which the potential is V , now a function of x, y, z , we are to make

$$u \equiv \int [\rho V + \lambda f(x, y, z) + \frac{1}{2} \mu (x'^2 + y'^2 + z'^2 - 1)] ds,$$

a minimum, λ and μ being functions of s alone, to be determined so that $x'^2 + y'^2 + z'^2 = 1$ and that $f(x, y, z) = 0$.

The terminals being fixed, we vary x, y, z alone, keeping s constant.

$$\text{Then } \delta u = \int \left[\rho (V_x \delta x + \dots) + \lambda (f_x \delta x + \dots) + \mu \left(x' \frac{d}{ds} \delta x + \dots \right) \right] ds.$$

The terms of the third group may be integrated by parts.

$$\int \left(\mu x' \frac{d}{ds} \delta x \right) ds = [\mu x' \delta x] - \int \left\{ \frac{d}{ds} (\mu x') \delta x \right\} ds, \text{ etc.}$$

Hence, for a minimum, we have

$$\rho V_x + \lambda f_x - \frac{d}{ds} (\mu x') = 0,$$

with two similar equations.

These three equations, combined with $x'^2 + \dots = 1$ and $f(x, y, z) = 0$, are sufficient to determine λ, μ, x, y, z in terms of s .

PROBLEMS.

1. Given that $(x_1, y_1), (x_2, y_2)$ are two points movable in a plane, and such that their distance apart is always equal to a definite constant a , what must be the circumstances of the motion in order that we shall always have

$$x_1 \delta x_1 + x_2 \delta x_2 + y_1 \delta y_1 + y_2 \delta y_2 = 0 ?$$

[DE MORGAN, *D.C.*, p. 455.]

2. Prove that to the first order the variation of the integral

$$\int f(x, y, p) dx, \text{ with constant limits, is } \int \omega \left\{ \frac{\partial f}{\partial y} - \frac{d}{dx} \left(\frac{\partial f}{\partial p} \right) \right\} dx, \text{ where}$$

$$\omega \equiv \delta y - p \delta x \quad \text{and} \quad p = \frac{dy}{dx}.$$

Determine a curve joining the origin to the point $(a, 1)$ for which the integral $\int (p^2 + n^2 y^2) dx$ has a minimum value. [MATH. TRIP., 1896.]

3. Prove that the shortest time path between two curves which lie in one plane when the velocity varies as the distance from a line in that plane, is the arc of a circle cutting the curves orthogonally, and having its centre on the line. [COLLEGES γ , 1893.]

4. Find the relation between y and p in a curve which makes $\int y^n \sqrt{1 + p^2} dx$ a maximum. Obtain the polar equation of the curve whose pole will generate this by rolling on a straight line.

[COLLEGES, 1877.]

5. A particle is moving under the action of a force perpendicular to and proportional to the distance from the line of zero velocity. Show that the brachistochrone is a circle. [TOWNSEND.]

6. Find the law of force parallel to the y -axis for which each of the following curves is brachistochronous, stating in each case the line of zero velocity and the pressure upon the curve :

Curve.	x -axis.	Curve.	x -axis.
1. Circle,	diameter.	2. Parabola,	directrix.
3. Parabola,	axis.	4. Catenary,	directrix.
5. Tractrix,	directrix.	6. Evolute of Para- bola,	axis.
7. Evolute of Catenary,	directrix.	8. Four-cusped hypo- cycloid,	line of oppo- site cusps.
9. Rect. Hyp.,	asymptote.	10. Bifocal conic,	axis.

[TOWNSEND.]

7. Find the law of central force for which each of the following curves is brachistochronous, stating whether the force is attractive or repulsive, the radius of the circle of zero velocity, and the pressure on the curve in each case :

Curve.	Pole.	Curve.	Pole.
1. Parabola,	focus.	2. Equiang. Spiral,	pole.
3. Cardioide,	pole.	4. Circle,	point on circumf.
5. Lemiscate of Bernoulli,	node.	6. Rect. Hyp.,	centre.
7. $r^n = a^n \cos n\theta$,	pole.	8. Invol. of Circle,	centre.
9. Epi- or hypo- cycloid,	cent. of fixed circle.	10. Reciprocal Spiral,	pole.
11. Central Conic,	centre.	12. Central Conic,	focus.

[TOWNSEND.]

8. Show that the curve of quickest descent under gravity from a given point to a given vertical straight line is a complete semi-cycloid with cusp at the given point.

9. Determine the minimum value of $\int_0^1 \left(\frac{dy}{dx}\right)^2 dx$, having given that

$$y_0 = 1 \quad \text{and} \quad \int_0^1 \frac{y}{y_1} dx = -1,$$

where y_0, y_1 are the values of y at the lower and upper limits respectively, and y_1 is subject to variation.

[ST. JOHN'S, 1883; TODHUNTER, *Hist. of Calc. Var.*]

10. Find the equation of a curve such that the area between it and the x -axis has a given value, whilst the area of the surface of revolution, bounded by it when revolving about the x axis, is a minimum. [Oxf. II. P., 1880.]

11. A piece of string of given length in the plane of the curve $ax^2 = y^2$, has its two ends movable on the two branches of the curve; find the form of the string when the area between the string and the curve is a maximum, and when that is the case prove that the string at each of its ends is at right angles to the curve. [St. John's, 1889.]

12. A surface of revolution has a given area, and its generating curve intersects the axis in given points; determine the form of the surface so that its volume may be greatest. [7, 1899.]

13. Show how to connect two fixed points by a curve of given length, so that the area bounded by the curve, the ordinates of the fixed points and the axis of abscissæ shall be a minimum. [Math. Trip., 1887.]

14. Find the curve in which at every point

$$\left\{ y + (m - x) \frac{dy}{dx} \right\} \left\{ y + (n - x) \frac{dy}{dx} \right\}$$

is a maximum or a minimum. Interpret this problem geometrically. [Lacroix, *Calc. Diff.*, II., p. 689.]

15. Prove by means of the Calculus of Variations that the minimum value of $\int_{x_0}^{x_1} (a - x)^2 \left(\frac{dy}{dx} \right)^2 dx$ is $(y_1 - y_0)^2 (a - x_1)(a - x_0) / (x_1 - x_0)$, where y_0, y_1 are the values of y corresponding respectively to the initial and final values of x , and supposing that $\frac{dy}{dx}$ does not become infinite between the limits. [Oxf. II. P., 1885.]

16. Find what functions of x , satisfying the conditions $y = 0$, when $x = 0$ and when $x = l$, make $\int_0^l \left(\frac{dy}{dx} \right)^2 dx$ stationary in value when $\int_0^l y^2 dx$ is given. [Math. Trip., 1876.]

17. Show that the equation in polar coordinates to the plane curve of given length, for which $\int \frac{ds}{r}$ is a maximum or minimum, is of one of the forms

$$\frac{a}{r} = \sqrt{1 - m^2} - \cos m(\theta - \alpha), \quad \frac{a}{r} = \cosh m(\theta - \alpha) - \sqrt{1 + m^2}.$$

[Oxf. II. P., 1890.]

18. A lamina of given mass is symmetrical with respect to an axis, and its density at any point varies as the square of the abscissa measured from one end of its axis; if the attraction upon a particle at that point of the axis be a maximum, prove that the lamina is bounded by the oval $r^2 = \sqrt{\frac{32m}{3\pi\sigma}} \cos\theta$, where m is the given mass and σ the density at unit distance along the axis, assuming the law of attraction to be that of the inverse square of the distance.

[MATH. TRIP., 1875.]

19. A curve passing through the point whose polar coordinates are $a, a \cos^{-1}e$, is such that $\int \{2r^{-1} - a^{-1}\}^{\frac{1}{2}} ds$, taken along the arc of the curve between the initial line and the given point, is a minimum. Prove that, provided that $2r^{-1} - a^{-1}$ is always finite and greater than zero, the required curve cuts the initial line at right angles in two points, the sum of whose distances from the origin is $2a$; and find the equation of the curve.

[Oxf. II. P., 1903.]

Interpret the result dynamically.

20. If $\int \sqrt{\lambda + \mu p^2} dx$ has a maximum or minimum, and λ, μ are independent of p and of any higher differential coefficients, and the differential equation resulting is satisfied by $y = ax + b$ for all constant values of a and b , prove that λ and μ must be mere constants.

[Oxf. II. P., 1918.]

21. A swimmer who can swim at a given rate v starts from the bank of a wide straight river, and the strength of the current varies directly as the distance from the bank. He wishes to get as far down the river as he can in a given time T . Show that he must start from the bank at an angle whose tangent is proportional to T . Show also that the tangents of the angles his direction of swimming makes with the bank at equal intervals of time are in arithmetical progression, and that at the end of the time T he is swimming directly down stream. If the x -axis be taken along the river bank, μy the velocity of the stream and α his initial angle with the bank, show that he is ultimately swimming at a distance $2v \sec^2 \frac{\alpha}{2} / \mu \cos \alpha$ from the bank.

22. An oval curve of given length rolls on a straight line; find its form when the area traced out in one revolution by a given

point on the plane of the curve is a minimum, the boundaries of the area being the curve traced out by the moving point, the given straight line and two perpendiculars upon it from the extremities of the curve. [MATH. TRIP., 1870.]

23. If the velocity of a carriage along a road be proportional to the cube of the cosine of the inclination of the road to the horizon, determine the path of quickest ascent from the bottom to the top of a hemispherical hill, and show that it consists of the spherical curve described by a point of a great circle which rolls on a small circle described about the pole with a radius $\pi/6$, together with an arc of a great circle. How is the discontinuity introduced into this problem? [MATH. TRIP., 1873.]

24. If $r^2 = x^2 + y^2$ and $ds^2 = dx^2 + dy^2$, prove, assuming such results of theory as may be convenient, that the curves along which from point to point $\int r ds$ is a maximum or minimum are rectangular hyperbolae. [OXF. II. P., 1886.]

25. Find the curve of given length joining two fixed points, which is such that the distance of the centroid of the arc from the chord connecting the two points may be the greatest possible. [OXF. II. P., 1887.]

26. A variable curve of given length $\pi a\sqrt{2}/4$ has one extremity at a fixed point $(3a, a)$ and the other on a fixed line $x = 2a$. Show that when the area enclosed by the curve, the axis of x and the lines $x = 2a$, $x = 3a$, is a maximum the curve is one-eighth of a circle. [OXF. II. P., 1888.]

27. On the surface of an ellipsoid a curve is drawn which intersects at a constant angle all the geodesics passing through a given umbilic. Prove that its total length from umbilic to umbilic is $l \sec \alpha$, where l is the geodesic distance between that umbilic and the opposite one. [MATH. TRIP. I., 1888.]

28. Find the form of the function p , in order that $\int \left(p + \frac{d^2 p}{d\psi^2} \right) p d\psi$ may be a maximum, subject to the condition that $\int \left(p + \frac{d^2 p}{d\psi^2} \right) d\psi$ is constant, and interpret the result geometrically. [OXF. II. P., 1889.]

29. A man swims from a point on the bank of a straight river to a point in mid-stream, with a constant velocity relative to the water.

Prove that, in order that the passage may occupy the shortest time, his actual course must be straight if the strength of the current is constant, but that if the strength of the current is proportional to the distance from the bank the path must have for its equation

$$y = c\sqrt{(cb+x)^2 - b^2} - \frac{cb}{2}\sqrt{c^2 - 1} - \frac{(cb+x)\sqrt{(cb+x)^2 - b^2}}{2b} + \frac{b}{2}\cosh^{-1}\frac{cb+x}{b} - \frac{b}{2}\cosh^{-1}c,$$

where the starting point is the origin, the bank is the axis of y , b the distance from the bank where the velocity of the stream is equal to that of the man relative to the water, and c is a constant. How is c obtained? [COLLEGES, 1896.]

30. Apply the principle of energy to determine the equation of equilibrium of an inextensible string under the action of a central force, its ends being fixed. [ST. JOHN'S, 1881.]

31. A heavy particle moves on the surface of a smooth circular cone with a vertical axis and vertex upwards. Find the brachistochrone from a fixed point on the surface to a fixed generating line. [ST. JOHN'S, 1881.]

32. Show that the curve, such that $\int r^n ds$ between two fixed points in the plane of the curve may be a minimum, is $r^{n+1} = a^{n+1} \sec(n+1)\theta$. [TRIN. COLL., 1881.]

33. A man walks up a uniform incline from a given point to reach a given height. His velocity varies as the sine of the angle between his path and the line of greatest slope on the incline. If he exhausts himself at a rate proportional to the product of the whole height ascended, and the square of the cosine of the inclination of his path to the line of greatest slope, show that he will get to the required height with least exertion along a curve whose equation is

$$y^3 = ax^2. \quad [\text{ST. JOHN'S COLL., 1883.}]$$

34. Prove that the minimum value of $\int (xy \, dx \, dy)^{\frac{1}{2}}$ between the limits $x = a, y = b$ and $x = a', y = b'$ is equal to $\frac{1}{2}(a^2 - a'^2)^{\frac{1}{2}}(b^2 - b'^2)^{\frac{1}{2}}$.

35. A curve is drawn on the surface $x(y+z) = a^2$ such that $\int \frac{ds}{x^2}$ is a maximum or a minimum; prove that $\left(\frac{ds}{dx}\right)^2 = \frac{c^4}{x^4} \frac{2x^4 + a^4}{2c^4 - x^4}$, c being an arbitrary constant. [ST. JOHN'S COLL., 1882.]

36. Show that the surface, whose superficial area is given and which encloses the greatest possible volume between itself and a given plane, has the sum of its curvatures at every point constant.

[MATH. TRIP., 1888.]

37. Geodesics are drawn upon the surface formed by the revolution of the curve $x = 2a \sec u$, $y = a(\sec u \tan u - \cosh^{-1} \sec u)$ about the y -axis. Show that the projections of these geodesics upon a plane perpendicular to the axis of revolution are of the forms of the inverses with regard to the origin of a certain Cotes's spiral.

38. Show that if S , H be two fixed points at distance apart $2a$, and O the mid-point of SH , the law of repulsive force from O under which the curve $SP \cdot HP = c^2$ can be described in a brachistochronous manner is one varying as $(OP^4 + d^4)(3OP^4 - d^4)/OP^3$ where $a^4 + d^4 = c^4$. Show also that the normal pressure upon the curve varies as

$$(OP^4 + d^4)^2(3OP^4 - d^4)/OP^5.$$

39. Find the variation, to the first order, of the integral

$$\int f(x, y, z) ds$$

taken along an arc of a curve traced on a surface $\phi(x, y, z) = 0$ between two given points of the surface; and show that if the integral have a maximum or minimum value the curve is found from the differential equations

$$\left[\frac{d}{ds} \left(V \frac{dx}{ds} \right) - \frac{\partial V}{\partial x} \right] / \frac{\partial \phi}{\partial x} = \left[\frac{d}{ds} \left(V \frac{dy}{ds} \right) - \frac{\partial V}{\partial y} \right] / \frac{\partial \phi}{\partial y} = \left[\frac{d}{ds} \left(V \frac{dz}{ds} \right) - \frac{\partial V}{\partial z} \right] / \frac{\partial \phi}{\partial z}.$$

The line joining the centre of curvature at any point P of the above curve to the centre of curvature of the corresponding normal section of the surface meets the tangent plane at P in G ; GT is perpendicular to GP , and PT is the tangent at P to that curve of the family $\phi = 0$, $V = \text{const.}$ which passes through P . Show that

$$V \left/ \frac{dV}{ds} \right. = GT.$$

[MATH. TRIP., 1897.]

40. A heavy particle moves on a smooth surface of revolution $z = f(\sqrt{x^2 + y^2})$, the axis of which is vertical and vertex upwards. Find the brachistochrone from a fixed point on the surface at a depth c below the vertex to a given meridian, and prove that the brachistochrone cuts the given meridian at right angles, and that the area swept over by the radius vector on a horizontal plane is proportional to the Action. If the brachistochrone be from the

fixed point to the curve defined by the equations $z = f(\sqrt{x^2 + y^2})$, $y + z = 2c$, prove that, if r and θ be cylindrical coordinates, the lower end of the brachistochrone is given by the equations

$$r \sin \theta + f(r) = 2c,$$

$$[\sin \theta + f'(r)]^2 = \cos^2 \theta [1 + \{f'(r)\}^2] / \left[\frac{r^2}{m^2 \{f(r) - c\}} - 1 \right].$$

[ST. JOHN'S COLL., 1884.]

41. Show that $\phi(x) \frac{d^n \psi(x)}{dx^n} - (-1)^n \psi(x) \frac{d^n \phi(x)}{dx^n}$ is an exact differential.

42. Show that the conditions that $\iiint V dx dx dx$ is integrable *per se*, where $V = \phi \{x, y, y', \dots, y^{(n)}\}$, are

$$\frac{\partial V}{\partial y} - \frac{d}{dx} \frac{\partial V}{\partial y'} + \frac{d^2}{dx^2} \frac{\partial V}{\partial y''} - \frac{d^3}{dx^3} \frac{\partial V}{\partial y'''} + \dots = 0$$

and

$$\frac{\partial V}{\partial y'} - 2 \frac{d}{dx} \frac{\partial V}{\partial y''} + 3 \frac{d^2}{dx^2} \frac{\partial V}{\partial y'''} - \dots = 0.$$

[TODHUNTER, I.C., p. 369.]

43. Show that the conditions that $\iiint V dx dx dx$ is integrable *per se* are those of Question 42, together with

$$1 \cdot 2 \frac{\partial V}{\partial y''} - 2 \cdot 3 \frac{d}{dx} \frac{\partial V}{\partial y'''} + 3 \cdot 4 \frac{d^2}{dx^2} \frac{\partial V}{\partial y^{(iv)}} - 4 \cdot 5 \frac{d^3}{dx^3} \frac{\partial V}{\partial y^{(v)}} + \dots = 0,$$

and generally, that V is integrable n times *per se*, provided that each of the functions $V, xV, x^2V, \dots, x^{n-1}V$ be so integrable *once*.

[TODHUNTER, I.C., p. 369.]

44. Show how to find the relation between x and y which will make the expression $\int_{x_0}^{x_1} f(x, y, x_1, y_1, x_0, y_0, p, p_1, p_0) dx$ a maximum or a minimum, it being given that x_1, y_1 are connected by an equation, and that x_0, y_0 are also connected by an equation.

A curve of given length l is drawn in the plane x, y so that one end is on the axis of the parabola $x^2 = 4ay$ and the other end on the arc of the parabola. If the figure revolves round the tangent at the vertex of the parabola, show that when the surface generated by the curve is the greatest possible the form of the curve is that of a portion of the catenary

$$l \cosh \frac{2a}{l} + a \operatorname{cosech} \frac{2a}{l} - y \sinh \frac{2a}{l} = l \cosh \left(\frac{x}{l} \sinh \frac{2a}{l} \right).$$

[MATH. TRIP., 1886.]

45. It is required to find a smooth guiding curve for a particle moving under gravity from rest, such that the *horizontal* space described in time t is the greatest possible. Show that the curve must be a cycloid, and that the space is gt^2/π .

[MATH. TRIP. II., 1914.]

46. Uniform elastic wire is held bent by proper forces between two points A and B so that the area between the wire and AB being given, the work expended in bending the wire may be the least possible. Show that the curvature at any point varies as $r^2 - a^2$, where $AB = 2a$ and r is the distance of the point from the middle point of AB . Show also that if the wire be bent completely round to satisfy the same conditions, the form of the wire will be given by $r^3 = c^3 \cos 3\theta$.

[MATH. TRIP., 1878.]

[It may be assumed that the work done in bending the wire is measured by $\frac{1}{2} \int \frac{a^2}{\rho^2} ds$.]

47. A right cone is capable of revolving freely round its axis, which is vertical. A groove is to be cut in the surface of the cone such that a particle of mass m sliding down the groove without initial velocity from a given point may in the shortest time reach a given point in the horizontal plane through the base of the cone; show that the differential equation of the particle's path projected on the horizontal plane is

$$\left(\frac{dr}{d\theta}\right)^2 = r^2 \left(\frac{r^2}{k^2} + 1\right) \left\{ \frac{r^2(r^2 + k^2)}{k^2(r - r_0)c} - 1 \right\} \sin^2 \alpha,$$

where α is the semi-vertical angle of the cone and mk^2 its moment of inertia about its axis.

[MATH. TRIP. III., 1885.]

48. A curve is drawn to touch two fixed straight lines at the fixed points P and Q . The area included by its pedal with respect to a fixed point O and the perpendiculars from O to the fixed tangents is a minimum, whilst the area included between the curve and the straight lines OP , OQ is constant. Show that the curve is part of an epi- or hypo-cycloid.

49. If a point move in a plane with velocity always proportional to the curvature of its path, show that the brachistochrone of continuous curvature between any two given points is a complete cycloid.

Prove that in the ordinary gravitation brachistochrone (which is also a cycloid), the velocity is inversely as the curvature of the path, and state the connexion between the two results.

[MATH. TRIP., 1875.]

50. Prove that the curve of a uniform chain of given length joining two fixed points is given by an equation of the form $y = b \operatorname{sn} K \frac{x}{a}$, when the moment of inertia of the chain about a given fixed line, in a plane with the two given points, is a maximum; and by an equation of the form $y \operatorname{cn} K \frac{x}{a} = b$, when the moment of inertia is a minimum, the given straight line being taken as the x -axis. [MATH. TRIP. III., 1884.]

51. Use the method of the Calculus of Variations to show that the general equation of the geodesics on a right circular cone, whose equation in polar coordinates is $\theta = a$, is $r \cos \{(\phi - \beta) \sin a\} = a$, where β and a are arbitrary constants. [OXF. II. P., 1914.]

52. Prove that the polar equation of the projection of a geodesic on a catenoid formed by the revolution of a catenary about its directrix upon a plane perpendicular to the directrix is of one of the forms

$$r \operatorname{sn} \left(\frac{\theta}{k}, k \right) = \operatorname{const}, \quad r \operatorname{sn} \theta = \operatorname{const}, \quad r \tanh \theta = \operatorname{const},$$

and distinguish the cases.

[MATH. TRIP. III. 1884, II. 1913; GREENHILL, *E.F.*, p. 96.]

53. Prove that if, from any point of a surface, geodesic lines of equal length be drawn in all directions, the curve which is the locus of their extremities cuts all the geodesics at right angles

54. Prove that on the surface of revolution determined by the equations

$$x = ak \cos \omega \cos \phi, \quad y = ak \cos \omega \sin \phi, \quad z = a \int_0^\omega \sqrt{1 - k^2 \sin^2 \omega} d\omega,$$

the equation of a geodesic line is $\tan \omega = A \sin k(\phi + \beta)$.

Prove also that the locus of the extremities of geodesic lines of length $\frac{1}{2} \pi a$ drawn from the point at which $\omega = \Omega$ and $\phi = 0$ is

$$\cos k\phi + \tan \omega \tan \Omega = 0.$$

[MATH. TRIP., 1896.]

55. Prove that the projection of a geodesic on a surface of revolution on a plane perpendicular to the axis is in polar coordinates $r^{-2} = \alpha^{-2} \operatorname{cn}^2 \mu \theta + \beta^{-2} \operatorname{sn}^2 \mu \theta$, if the meridian curve of the surface is the roulette of the focus of an ellipse rolling upon the axis, α and β denoting the greatest and least values of the focal distances.

Show that if the geodesic cuts the meridian plane at its maximum distance at an angle γ , then

$$\mu = \beta \cot \gamma / (\alpha + \beta), \quad \beta^2 k^2 = (\alpha^2 - \beta^2) \tan^2 \gamma.$$

[MATH. TRIP. III., 1885.]

56. The line element of a certain surface is expressed in terms of parameters u and v by the equation

$$ds^2 = \{(du)^2 + (dv)^2 - (u dv - v du)^2\} / (1 - u^2 - v^2)^2.$$

Prove that the equations of the geodesics on the surface are of the form $au + bv + c = 0$, where a, b, c are constants.

[MATH. TRIP. II., 1920.]

57. Prove that a surface for which

$$ds^2 = \{dx^2 + dy^2 - (x dy - y dx)^2\} / (1 - x^2 - y^2)^2$$

has its geodesics represented by straight lines on the plane of $x-y$ and its geodesic circles by conics having double contact with $x^2 + y^2 - 1 = 0$, and the geodesic distance ρ between (x_0, y_0) and (x, y) being given by

$$(1 - x_0^2 - y_0^2)(1 - x^2 - y^2) \cosh^2 \rho = (1 - xx_0 - yy_0)^2.$$

Prove also that the specific curvature is constant and equal to -1 .

[MATH. TRIP. II., 1919.]

58. Show that the conditions that the parametric curves may be geodesics on the surface of which the line element is given by $ds^2 = E du^2 + 2F du dv + G dv^2$ are respectively that $(E du + F dv) / \sqrt{E}$ and $(F du + G dv) / \sqrt{G}$ must be complete differentials. Show also that if these conditions be satisfied, the specific curvature at a point of the surface is $\frac{1}{V} \frac{\partial^2 \omega}{\partial u \partial v}$, where $V^2 = EG - F^2$ and ω is the angle between the parametric curves at the point.

[MATH. TRIP. II., 1919.]

CHAPTER XXXIV. (*Continued*). SECTION II.

DOUBLE INTEGRALS, ETC. CULVERWELL'S
METHOD OF DISCRIMINATION.

1547. **Double Integrals. The Case of two Independent Variables.**

Suppose there are two independent variables and a dependent one z which is a function of x and y , but of unspecified form. Let (p, q) , (r, s, t) , (u, v, w, m) , etc., be the partial differential coefficients of z with regard to x and y , of the first, second, third, etc., orders. That is,

$$p \equiv \frac{\partial z}{\partial x}, \quad q \equiv \frac{\partial z}{\partial y}; \quad r \equiv \frac{\partial^2 z}{\partial x^2}, \quad s \equiv \frac{\partial^2 z}{\partial x \partial y}, \quad t \equiv \frac{\partial^2 z}{\partial y^2}; \quad u \equiv \frac{\partial^3 z}{\partial x^3}, \text{ etc.}$$

We shall also use capital letters with the following signification, viz.:

$$X \equiv \frac{\partial V}{\partial x}, \quad Y \equiv \frac{\partial V}{\partial y}, \quad Z \equiv \frac{\partial V}{\partial z}, \quad P \equiv \frac{\partial V}{\partial p}, \quad Q \equiv \frac{\partial V}{\partial q}, \quad R \equiv \frac{\partial V}{\partial r}, \text{ etc.,}$$

and the notation

$$P_x \equiv \frac{\partial \cdot P}{\partial x}, \quad Q_y \equiv \frac{\partial \cdot Q}{\partial y}, \quad R_{xx} \equiv \frac{\partial^2 \cdot R}{\partial x^2}, \text{ etc.,}$$

the dots being intended as a reminder to the reader that the letters x and y not only occur explicitly in the several subjects of partial differentiation, but also implicitly through the presence of z and its partial differential coefficients.

1548. We propose to discuss the variation of $\iint V dx dy$, where V is a function of $x, y, z; p, q; r, s, t; u, v, w, m; \text{ etc.}$, and the integration ranges over the region bounded by a

given contour in the x - y plane. Moreover, we shall assume that V and the several differential coefficients occurring remain finite, continuous, and single valued at all points of the region bounded, and at all points lying upon its contour.

For each point x, y we shall suppose an infinitesimally small variation of position arbitrary from point to point and denoted as before by $\delta x, \delta y$.

Now x and y being independent, δx ought not to vary in consequence of changes in y , nor should δy vary in consequence of changes in x . We should therefore have $\frac{\partial}{\partial y} \delta x = 0, \frac{\partial}{\partial x} \delta y = 0$.*

For convenience in the analysis, then, we shall suppose the variation δx in x to be the same for all points which lie on the same ordinate in the x - y plane, and similarly the variation δy in y to be the same for points which lie on the same line parallel to the x -axis. The variations being quite at our choice from point to point, we are entitled to do this. In other words, we shall assume δx and δy to be respectively independent of y and x . And this supposition in no way limits the results arrived at. The supposition that δx and δy might be functions of both x and y is discussed by Poisson (*Mém. de l'Institut*, T. xii.), and the investigation there given leads to precisely the same result as that obtained by the supposition here made. [See De Morgan, *D. and I.C.*, p. 454.]

1549. Preliminary Considerations.

If any function $\chi(x, y)$ be varied by changing x to $x + \delta x$, we have, as in Art. 1492,

$$\delta \chi_x = \delta \frac{\partial \chi}{\partial x} = \frac{\partial}{\partial x} \delta \chi - \frac{\partial \chi}{\partial x} \frac{d \delta x}{dx} = \frac{\partial}{\partial x} (\delta \chi - \chi_x \delta x - \chi_y \delta y) + \chi_{xx} \delta x + \chi_{xy} \delta y,$$

$$\text{i.e.} \quad \delta \chi_x - \chi_{xx} \delta x - \chi_{xy} \delta y = \frac{\partial}{\partial x} (\delta \chi - \chi_x \delta x - \chi_y \delta y).$$

Thus, if we write ω for $\delta z - p \delta x - q \delta y$, we have

$$\begin{aligned} \delta p - r \delta x - s \delta y &= \omega_x, & \delta q - s \delta x - t \delta y &= \omega_y; & \delta r - u \delta x - v \delta y &= \omega_{xx}, \\ \delta s - v \delta x - w \delta y &= \omega_{xy}, & \delta t - w \delta x - m \delta y &= \omega_{yy}; & \text{etc.} \end{aligned}$$

equations similar to those of Art. 1492 for one independent variable.

* Lacroix, *C.D. et I.*, T. ii., p. 679.

Again, to the first order,

$$\delta V = X \delta x + Y \delta y + Z \delta z + P \delta p + Q \delta q + R \delta r + S \delta s + T \delta t + \dots,$$

whilst $\frac{\partial V}{\partial x} = X + Zp + Pr + Qs + Ru + Sv + Tw + \dots,$

$$\frac{\partial V}{\partial y} = Y + Zq + Ps + Qt + Rv + Sw + Tm + \dots;$$

$$\therefore \delta V - \frac{\partial V}{\partial x} \delta x - \frac{\partial V}{\partial y} \delta y = Z\omega + P\omega_x + Q\omega_y + R\omega_{xx} + S\omega_{xy} + T\omega_{yy} + \dots,$$

to the first order.

1550. Variation of $\iint V dx dy.$

Let the region of integration be bounded by any specific closed contour, consisting either of one closed curve or of a system of arcs of different curves in the x - y plane, each of

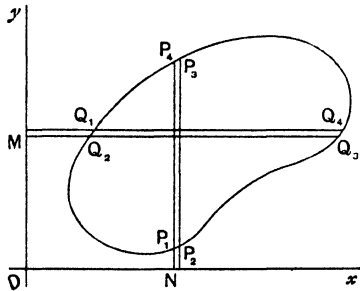

Fig. 449.

such arcs being itself subject to variation. Let the region in question be such as shown in Fig. 449. We have

$$\delta \iint V dx dy = \iint \delta(V dx dy) = \iint \delta V dx dy + \iint V \delta x dy + \iint V dx \delta y.$$

Now
$$\iint V \delta x dy = \int \left[V \frac{d \delta x}{dx} dx \right] dy.$$

Integrating $\int V \frac{d \delta x}{dx} dx$ for a strip $Q_2Q_3Q_4Q_1$ defined by contiguous lines MQ_2Q_3, Q_1Q_4 parallel to the x -axis, we have

$$[V \delta x]_{at Q_3} - [V \delta x]_{at Q_2} - \int_{MQ_2}^{MQ_3} \left(\frac{\partial V}{\partial x} \delta x \right) dx,$$

and this is to be integrated with regard to y to add up the

results for all such strips. Let $d\sigma$ be an element of the arc of the contour; then

$$\int \{ [V \delta x]_{\text{at } Q_3} - [V \delta x]_{\text{at } Q_2} \} dy = \int \left\{ \left[V \delta x \frac{dy}{d\sigma} \right]_{\text{at } Q_3} + \left[V \delta x \frac{dy}{d\sigma} \right]_{\text{at } Q_2} \right\} d\sigma,$$

for, if we integrate with regard to σ travelling in the positive or counter-clockwise direction, the value of dy in passing from Q_1 to Q_2 is of opposite sign to that of dy in passing from Q_3 to Q_4 . Thus, this integration yields $\int \left(V \delta x \frac{dy}{d\sigma} \right) d\sigma$ taken round the perimeter. Hence, double integration referring to integration for the whole area bounded by the contour, and single integration to that taken in a positive direction round the perimeter,

$$\iint V d \delta x dy = \int \left(V \delta x \frac{dy}{d\sigma} \right) d\sigma - \iint \left(\frac{\partial V}{\partial x} \delta x \right) dx dy.$$

In the same way, with $\iint V dx d\delta y$, we have

$$\int V d \delta y = \int V \frac{d\delta y}{dy} dy$$

for a strip $P_1P_2P_3P_4$, defined by the contiguous lines NP_1P_4 , P_2P_3 , parallel to the y -axis, which is

$$[V \delta y]_{\text{at } P_4} - [V \delta y]_{\text{at } P_1} - \int_{NP_1}^{NP_4} \left(\frac{\partial V}{\partial y} \delta y \right) dy,$$

and this is to be integrated with regard to x to add up the results for all such strips; then

$$\begin{aligned} \int \{ [V \delta y]_{\text{at } P_4} - [V \delta y]_{\text{at } P_1} \} dx &= - \int \left\{ \left[V \delta y \frac{dx}{d\sigma} \right]_{\text{at } P_4} + \left[V \delta y \frac{dx}{d\sigma} \right]_{\text{at } P_1} \right\} d\sigma \\ &= - \int \left(V \delta y \frac{dx}{d\sigma} \right) d\sigma \text{ round the perimeter.} \end{aligned}$$

$$\text{Hence } \iint V dx d\delta y = - \int \left(V \delta y \frac{dx}{d\sigma} \right) d\sigma - \iint \left(\frac{\partial V}{\partial y} \delta y \right) dx dy.$$

Therefore the total result of the variation is to the first order

$$\begin{aligned} \delta \iint V dx dy &= \int V \left(\delta x \frac{dy}{d\sigma} - \delta y \frac{dx}{d\sigma} \right) d\sigma + \iint \left(\delta V - \frac{\partial V}{\partial x} \delta x - \frac{\partial V}{\partial y} \delta y \right) dx dy \\ &= \int V \left(\delta x \frac{dy}{d\sigma} - \delta y \frac{dx}{d\sigma} \right) d\sigma, \text{ round the perimeter,} \\ &+ \iint (Z\omega + P\omega_x + Q\omega_y + R\omega_{xx} + S\omega_{xy} + T\omega_{yy} + \dots) dx dy, \\ &\text{over the area.} \end{aligned}$$

1551. In proceeding further it will be sufficient for our purposes to limit the discussion to the case where

$$V = \phi(x, y, z; p, q; r, s, t),$$

containing no partial differential coefficients of z of higher order than the second. For this will include all cases likely to be useful, and in any case if higher order differential coefficients should occur the process to be followed would be the same.

Now, by Arts. 471 and 472, writing ω for U ,

$$\iint (P\omega_x + Q\omega_y) dx dy = - \iint \omega \left(\frac{\partial P}{\partial x} + \frac{\partial Q}{\partial y} \right) dx dy + \int \omega \left(P \frac{dy}{d\sigma} - Q \frac{dx}{d\sigma} \right) d\sigma$$

and $\iint (R\omega_{xx} + S\omega_{xy} + T\omega_{yy}) dx dy = \iint \omega \left(\frac{\partial^2 R}{\partial x^2} + \frac{\partial^2 S}{\partial x \partial y} + \frac{\partial^2 T}{\partial y^2} \right) dx dy$

$$+ \iint \left[\left\{ \frac{\omega}{T}, \frac{\omega_y}{T_y} \right\} + S_x \omega \right] \frac{dx}{d\sigma} + \left\{ \frac{R}{\omega}, \frac{R_x}{\omega_x} \right\} + S\omega_y \left] \frac{dy}{d\sigma} \right] d\sigma,$$

where in each case the line integral is taken in the positive direction round the contour of the region.

Thus we have $\delta \iint V dx dy = [H] + \iint K \omega dx dy,$

where $K = Z - \frac{\partial P}{\partial x} - \frac{\partial Q}{\partial y} + \frac{\partial^2 R}{\partial x^2} + \frac{\partial^2 S}{\partial x \partial y} + \frac{\partial^2 T}{\partial y^2}$

and $H = \int V \left(\delta x \frac{dy}{d\sigma} - \delta y \frac{dx}{d\sigma} \right) d\sigma + \int \omega \left(P \frac{dy}{d\sigma} - Q \frac{dx}{d\sigma} \right) d\sigma$

$$+ \iint \left[\left\{ \frac{\omega}{T}, \frac{\omega_y}{T_y} \right\} + S_x \omega \right] \frac{dx}{d\sigma} + \left\{ \frac{R}{\omega}, \frac{R_x}{\omega_x} \right\} + S\omega_y \left] \frac{dy}{d\sigma} \right] d\sigma.$$

The terms of the group H depend solely upon the variations at the boundary of the contour. The terms in the surface integral are multiplied by the variation ω , i.e. by $\delta z - p\delta x - q\delta y$, which varies arbitrarily from point to point of the area bounded by the contour.

1552. Conditions for a Stationary Value.

As in the case of one independent variable, if the functional relation of z with x and y is to be determined so that $\iint V dx dy$ is to have a stationary value, i.e. so that $\delta \iint V dx dy = 0$, we must have in the first place $K=0$, viz. a differential equation

between z , x and y ; and in addition the coefficients of the several independent variations in the limit terms $[H]$ must also vanish.

1553. The Differential Equation.

For the case considered, viz. $V \equiv \phi(x, y, z; p, q; r, s, t)$, the equation $K=0$ is a partial differential equation, in general of the fourth order.

Forsyth (*Diff. Eq.*, Ch. X.) discusses the solution of some forms of Partial Differential Equations of the second and higher order, but so far, even in the case of partial differential equations of the second order, it is only possible to perform the integration in special cases.

The chief methods available are in the cases in which the equation takes the form

(α) $Ar + Bs + Ct = U$ } where A, B, C, D, U are
 or (β) $Ar + Bs + Ct + D(rt - s^2) = U$, } functions of x, y, z, p and q ,
 for which we have the methods of Monge and of Ampère
 (Forsyth, Arts. 232, 265).

These methods, however, are purely tentative and may fail.

(γ) We have also an important method known as the Principle of Duality, which amounts to reciprocation with regard to a quadric, usually taken as an elliptic paraboloid (Forsyth, Arts. 197 and 242).

(δ) For equations of form $A = (rt - s^2)^n B$, where A is a function of p, q, r, s, t , homogeneous with regard to r, s and t ; and B a function of x, y, z, p, q , remaining finite when $rt = s^2$, we have Poisson's method, which begins with the assumption of a functional relation between p and q , and which thereby limits any solution to be found in that way to developable surfaces satisfying the equation.

(ϵ) We have the case where the differential equation is of the class "linear with constant coefficients."

(ζ) There are also various miscellaneous methods applicable in particular cases.

The solution of the equation $K=0$ is therefore in any but very simple cases, in the present state of knowledge of the mode of treatment of Partial Differential Equations, an insuperable barrier.

When r, s, t are absent and $V \equiv \phi(x, y, z, p, q)$, we have $K \equiv Z - \frac{\partial \cdot P}{\partial x} - \frac{\partial \cdot Q}{\partial y}$, and $K=0$ is in general an equation of the second order, and if it be of one of the forms enumerated a solution may perhaps be effected.

Ex. It is required to discover the class of surfaces for which $\iint (p^2 + q^2) dx dy$ has a stationary value.

Here $V = p^2 + q^2$, $Z = 0$, $P = 2p$, $Q = 2q$; and $K=0$ becomes $\frac{\partial^2 z}{\partial x^2} + \frac{\partial^2 z}{\partial y^2} = 0$, whence $z = F_1(x + iy) + F_2(x - iy)$.

1554. It will be seen, however, that in some cases, even when the solution of the equation $K=0$ in general terms is impossible, important geometrical properties of the class of surfaces satisfying it may nevertheless be deduced.

1555. If V be of form $V \equiv A + Br + 2Cs + Dt + E(rt - s^2)$, the capitals A, B, C, D, E being functions of x, y, z, p, q , it will be found by ordinary differentiation that the function K is an expression of the same type. Thus $K=0$ becomes in this case an equation of the nature to which the tentative processes of Monge or Ampère may be applied.

1556. The Boundary Conditions.

Taking the case $V \equiv \phi(x, y, z; p, q; r, s, t)$, we have

$$[H] = \int \left[V \left(\delta x \frac{dy}{d\sigma} - \delta y \frac{dx}{d\sigma} \right) + \omega \left(P \frac{dy}{d\sigma} - Q \frac{dx}{d\sigma} \right) \right. \\ \left. + \left\{ \left| \begin{matrix} \omega, & \omega_y \\ T, & T_y \end{matrix} \right| + S_x \omega \right\} \frac{dx}{d\sigma} + \left\{ \left| \begin{matrix} R, & R_x \\ \omega, & \omega_x \end{matrix} \right| + S_y \omega \right\} \frac{dy}{d\sigma} \right] d\sigma,$$

which is to vanish when taken round the contour of the region.

There will be as many equations resulting from this as there are independent boundary variations amongst the three $\delta x, \delta y, \delta z$, and this will depend upon the nature of the boundary.

Take the case r, s, t absent, *i.e.* $V \equiv \phi(x, y, z; p, q)$.

$$\text{Then } [H] = \int \left[(V \delta x + \omega P) \frac{dy}{d\sigma} - (V \delta y + \omega Q) \frac{dx}{d\sigma} \right] d\sigma,$$

where $\omega = \delta z - p \delta x - q \delta y$.

1557. The ordinary cases occurring in geometrical applications are :

(i) When the boundary is altogether unspecified.

(ii) When the surface to be discovered is to pass through a given plane curve fixed in space.

(iii) When the surface is to be bounded by a curve which lies on a given surface but is otherwise unspecified.

(iv) When in the latter case that given surface is a plane, to which the z -plane may be taken as parallel.

Take the case $V \equiv \phi(x, y, z; p, q)$ and consider these cases.

(i) Boundary unspecified. Here $\delta x, \delta y, \delta z$ are all independent at the boundary. Hence

$$P \frac{dy}{d\sigma} - Q \frac{dx}{d\sigma} = 0, \quad V \frac{dy}{d\sigma} - p \left(P \frac{dy}{d\sigma} - Q \frac{dx}{d\sigma} \right) = 0,$$

$$V \frac{dx}{d\sigma} + q \left(P \frac{dy}{d\sigma} - Q \frac{dx}{d\sigma} \right) = 0,$$

that is, $P \frac{dy}{d\sigma} - Q \frac{dx}{d\sigma} = 0$ and $V = 0$ are to hold at all points of the boundary for which all conditions are unassigned.

(ii) Boundary a given fixed curve in a plane parallel to the x - y plane.

Here z is incapable of variation at all points of the boundary, *i.e.* $\delta z = 0$. Also at all points of the boundary,

$$\frac{\delta y}{\delta x} = \frac{dy}{dx}, \quad \text{i.e.} \quad \delta x \frac{dy}{d\sigma} = \delta y \frac{dx}{d\sigma}.$$

Hence $P \frac{dy}{d\sigma} - Q \frac{dx}{d\sigma} = 0$ for all points of the fixed boundary.

(iii) If the boundary of the surface sought is to be on a fixed surface, $\phi(x, y, z) = 0$, but to be otherwise unspecified, we have $\phi_x \delta x + \phi_y \delta y + \phi_z \delta z = 0$, *i.e.* $\delta z = -\frac{\phi_x}{\phi_z} \delta x - \frac{\phi_y}{\phi_z} \delta y$; $\delta x, \delta y$ being independent variations.

Hence

$$\left[V \delta x - P \left(p + \frac{\phi_x}{\phi_z} \right) \delta x - P \left(q + \frac{\phi_y}{\phi_z} \right) \delta y \right] \frac{dy}{d\sigma}$$

$$- \left[V \delta y - Q \left(p + \frac{\phi_x}{\phi_z} \right) \delta x - Q \left(q + \frac{\phi_y}{\phi_z} \right) \delta y \right] \frac{dx}{d\sigma} = 0,$$

and therefore

$$\begin{aligned} V \frac{dy}{d\sigma} &= \left(P \frac{dy}{d\sigma} - Q \frac{dx}{d\sigma} \right) \left(p + \frac{\phi_x}{\phi_z} \right), \\ V \frac{dx}{d\sigma} &= - \left(P \frac{dy}{d\sigma} - Q \frac{dx}{d\sigma} \right) \left(q + \frac{\phi_y}{\phi_z} \right). \end{aligned}$$

Remembering also that $dz = p dx + q dy$ at all points of the surface to be discovered, and that $\phi_x dx + \phi_y dy + \phi_z dz = 0$ along the boundary, we have $(\phi_x + p\phi_z) dx + (\phi_y + q\phi_z) dy = 0$ along the boundary, *i.e.* $dx/(\phi_y + q\phi_z) = -dy/(\phi_x + p\phi_z)$.

Hence the equations obtained above become

$$\{P(\phi_x + p\phi_z) + Q(\phi_y + q\phi_z)\}(\phi_x + p\phi_z) - V(\phi_x + p\phi_z)\phi_z = 0$$

$$\text{and } \{P(\phi_x + p\phi_z) + Q(\phi_y + q\phi_z)\}(\phi_y + q\phi_z) - V(\phi_y + q\phi_z)\phi_z = 0,$$

i.e. they each reduce to $V\phi_z = P(\phi_x + p\phi_z) + Q(\phi_y + q\phi_z)$, or $(V - Pp - Qq)\phi_z = P\phi_x + Q\phi_y$, which is to hold at all points of the bounding line upon the given surface.

(iv) When the surface is merely a plane $z = \text{const.}$,

$$\phi_x = 0, \quad \phi_y = 0, \quad \phi_z = 1,$$

and the condition becomes $V - Pp - Qq = 0$, which is to hold at all points of the bounding line which lies on the given plane.

1558. Relative Maxima and Minima.

In the case where a maximum or minimum value of $u \equiv \iint V dx dy$ is sought conditionally upon a second surface integral $V \equiv \iint W dx dy$ retaining a definite value a , the same process applies as already employed in the case of a single independent variable (Art. 1504), *viz.* to make

$$\iint (V + \lambda W) dx dy$$

an unconditional maximum or minimum. For it is obvious that if u is to be a maximum or minimum, $u + \lambda a$ is a maximum or minimum, *i.e.* $\iint (V + \lambda W) dx dy$ is so also.

1559. **Surfaces of Maximum or Minimum Area ; Bubbles.**

Apply the theorems now established to obtain the condition that $\iint \sqrt{1+p^2+q^2} dx dy$ shall have a stationary value. That is, we are to find the nature of a surface which, whilst satisfying certain bounding conditions which may be subsequently imposed, is to have a maximum or minimum curved area.

Here $V = \sqrt{1+p^2+q^2}$, $X = Y = Z = 0$, $P = \frac{p}{\sqrt{1+p^2+q^2}}$, $Q = \frac{q}{\sqrt{1+p^2+q^2}}$.

The equation $K=0$ gives $\frac{\partial P}{\partial x} + \frac{\partial Q}{\partial y} = 0$, i.e.

$$\frac{r}{(1+p^2+q^2)^{\frac{3}{2}}} - \frac{p(pr+qs)}{(1+p^2+q^2)^{\frac{3}{2}}} + \frac{t}{(1+p^2+q^2)^{\frac{3}{2}}} - \frac{q(ps+qt)}{(1+p^2+q^2)^{\frac{3}{2}}} = 0,$$

i.e. $(1+p^2+q^2)(r+t) = p^2r + 2pqs + q^2t,$

or $(1+p^2)t - 2pqs + (1+q^2)r = 0.$

This is a second order partial differential equation to determine z as a function of x and y . Without proceeding to its solution, it will be noticed that since the equation giving the principal radii of curvature at any point of a surface $z=f(x, y)$ is

$$(rt - s^2)\rho^2 - \sqrt{1+p^2+q^2}\{(1+p^2)t - 2pqs + (1+q^2)r\}\rho + (1+p^2+q^2)^2 = 0,$$

this equation reduces for such surfaces as we are searching for to

$$\rho^2 = (1+p^2+q^2)^2 / (s^2 - rt).$$

The roots are equal and of opposite sign. And if ρ_1, ρ_2 be the roots, $\rho_1 + \rho_2 = 0$, or what is the same thing, $\frac{1}{\rho_1} + \frac{1}{\rho_2} = 0$, i.e. the sum of the principal curvatures is zero, and the surface is an anticlastic one with this peculiarity. Moreover, this is the condition of equilibrium (stable or unstable) of possible shapes of soap-bubble films with equal pressures on opposite sides of the film. For the hydrostatic equation for that difference of pressure is $p = \frac{\tau}{\rho} + \frac{\tau}{\rho'}$, where τ is the surface tension. And it will be recalled that a number of known surfaces satisfy this condition and are possible forms for soap-bubble films, e.g. the catenoid formed by the revolution of a catenary about its directrix; and this is the only possible form if it is to be also a surface of revolution. The helicoidal surface and the surfaces $e^z = \cos y \sec x$, $\sin z = \sinh x \sinh y$ are shown by Catalan to satisfy the same differential equation (*Journal de l'École Polytechnique*, 1856). See Besant, *Hydromech.*, p. 217, who refers to Darboux, *Théorie Générale de Surfaces*, T. i., Liv. iii., for a full discussion of minima surfaces.

Since the Potential Energy of a soap-bubble film is $\int \tau dS$, where τ is the surface tension and a constant, it will be evident that if the potential energy is to be a minimum the surface is to be a minimum.

If the pressure on opposite sides of the film be not the same, we have $\frac{1}{\rho} + \frac{1}{\rho'} = \frac{p}{\tau}$, and the mean curvature is constant but not in this case zero.

1560. If the boundary is to be on the surface $\phi(x, y, z) = 0$, the equation $(V - Pp - Qq)\phi_x = P\phi_x + Q\phi_y$ of Art. 1557 (iii) gives $\phi_x = p\phi_x + q\phi_y$, indicating that the minimum surface is to cut $\phi(x, y, z) = 0$ orthogonally at all points of the bounding curve.

1561. Let us next find the conditions that must hold when, for a given volume expressed by $\iint z dx dy$, we have a surface of maximum or minimum area.

We are then to make $\iint(\sqrt{1+p^2+q^2} + \lambda z) dx dy$ an unconditional maximum or minimum. Here

$V = \sqrt{1+p^2+q^2} + \lambda z$, $Z = \lambda$, $X = Y = 0$, $P = \frac{p}{\sqrt{1+p^2+q^2}}$, $Q = \frac{q}{\sqrt{1+p^2+q^2}}$; and $K \equiv Z - \frac{\partial P}{\partial x} - \frac{\partial Q}{\partial y} = 0$ gives, similarly to the work in the last case,

$$\lambda - \frac{(1+p^2)' - 2pqqs + (1+q^2)r}{(1+p^2+q^2)^{\frac{3}{2}}} = 0,$$

so that in this case we have $\frac{1}{\rho_1} + \frac{1}{\rho_2} = \lambda$, a constant, which is the case of soap-bubble films in equilibrium, with a constant difference of pressure on opposite sides, such as might be maintained by closing the ends in the case of a film in the form of a surface of revolution and maintaining a constant air pressure in the interior, so that, provided the temperature remains constant, the volume also remains constant.

It may be noted that a sphere and a right circular cylinder are surfaces which satisfy this differential equation, but that neither of them satisfy that of Art. 1559.

1562. **Case of a Surface of Revolution.**

This case may be discussed in an elementary way by making $\int 2\pi y ds$ a minimum whilst $\int \pi y^2 dx$ is constant; i.e. $\delta \int (y\sqrt{1+y'^2} + \lambda y^2) dx = 0$.

Here $V = y\sqrt{1+y'^2} + \lambda y^2$, $X = 0$, $Y = yy'/\sqrt{1+y'^2}$, whence $y\sqrt{1+y'^2} + \lambda y^2 = yy'/\sqrt{1+y'^2} + C$ or $y/\sqrt{1+y'^2} = C - \lambda y^2$.

One of the radii of curvature (ρ') of the surface is equal (in magnitude) to the normal (n) = $y\sqrt{1+y'^2}$. Thus, $\frac{1}{n} = \frac{C}{y^2} - \lambda$.

For the other, we have

$$\frac{dx}{ds} = \frac{C}{y} - \lambda y, \quad \frac{d^2x}{ds^2} = -\left(\frac{C}{y^2} + \lambda\right) \frac{dy}{ds},$$

and $\frac{1}{\rho} = -\frac{d^2x/ds^2}{ds} = \frac{C}{y^2} + \lambda$,

whence $\frac{1}{\rho} - \frac{1}{n} = 2\lambda$; and if ρ' be measured in the same direction as ρ , $\rho' = -n$, so that $\frac{1}{\rho} + \frac{1}{\rho'} = 2\lambda = \text{const.}$; the same result as before.

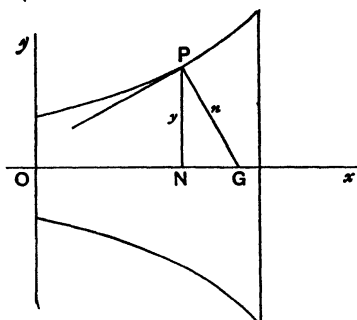

Fig. 450.

1563. It is convenient in many cases to choose a less general variation.

Let us take δx and δy both zero, but vary z and the partial differential coefficients of z . We shall then have

$$\omega = \delta z, \quad \omega_x = \delta p, \quad \omega_y = \delta q, \quad \omega_{xx} = \delta r, \quad \omega_{xy} = \delta s, \quad \omega_{yy} = \delta t.$$

With this variation the limiting terms $[H]$, when r, s, t are absent, reduce to

$$[H] = \left[\int \delta z \left(P \frac{dy}{d\sigma} - Q \frac{dx}{d\sigma} \right) d\sigma \right] \quad (\text{Art. 1556});$$

and for the very important case frequently occurring in geometrical applications, in which the region to be considered is bounded by a fixed closed curve in the plane of x - y , we have $\delta z = 0$ at every point of the bounding curve, so that $[H]$ vanishes identically.

The partial differential equation $K=0$ will, when solved, usually give z as a functional form containing x and y , and, in the case cited of a fixed boundary, the functional form occurring in the solution will have to be so chosen that the surface obtained passes through the bounding curve.

1564. Ex. Find whether a developable surface can be found which passes through the circle $z=0, x^2+y^2=a^2$, and for which $\iint \sqrt{1+p^2+q^2} dx dy$ has a stationary value.

The partial differential equation to be satisfied is

$$(1+p^2)t - 2pqs + (1+q^2)r = 0.$$

If the surface is to be developable, we must take $q=f(p)$.

This will give $[1+\{f(p)\}^2]-2pf(p)f'(p)+(1+p^2)\{f'(p)\}^2=0$,

i.e. $\{f(p)-pf'(p)\}^2=-1-\{f'(p)\}^2$ or $f(p)=pf'(p)+\sqrt{-1-\{f'(p)\}^2}$, which is of Clairaut's form (see *I.C. for Beginners*, p. 230), with a solution $f(p)=Ap+\sqrt{-1-A^2}$, i.e. $Ap-q=-\sqrt{-1-A^2}$.

Applying Lagrange's method to this (Forsyth, *D. Eq.*, Art. 184),

$$\frac{dx}{A} = \frac{dy}{-1} = -\frac{dz}{-\sqrt{-1-A^2}};$$

whence $x+Ay=B, z-y\sqrt{-1-A^2}=\phi(B)$,

i.e. $z=y\sqrt{-1-A^2}+\phi(x+Ay)$ is the functional solution sought.

If we take ϕ to be zero and A to be $\sqrt{-1}$, we have a solution of our problem, viz. $z=0$. The circular disc bounded by $x^2+y^2=a^2$ is the developable surface which has a minimum area, and the principal curvatures of the plane surface are both zero, so that all the conditions are satisfied.

1565. Consider the stationary value of $\iint U dS$, where dS is an element of the surface represented by a supposititious relation between x, y and z , and suppose that there is an accompanying condition that $\iint W dx dy = a$, taking U and W to be functions of x, y, z alone.

Here $V=U\sqrt{1+p^2+q^2}+\lambda W, Z=\frac{\partial U}{\partial z}\sqrt{1+p^2+q^2}+\lambda\frac{\partial W}{\partial z}$,

$$P=U\frac{p}{\sqrt{1+p^2+q^2}}, Q=U\frac{q}{\sqrt{1+p^2+q^2}},$$

$$\frac{\partial \cdot P}{\partial x} = \left(\frac{\partial U}{\partial x} + \frac{\partial U}{\partial z} p\right) \frac{p}{(1+p^2+q^2)^{\frac{3}{2}}} + U \frac{r}{(1+p^2+q^2)^{\frac{3}{2}}} - U \frac{p(pr+qs)}{(1+p^2+q^2)^{\frac{3}{2}}},$$

$$\frac{\partial \cdot Q}{\partial y} = \left(\frac{\partial U}{\partial y} + \frac{\partial U}{\partial z} q\right) \frac{q}{(1+p^2+q^2)^{\frac{3}{2}}} + U \frac{t}{(1+p^2+q^2)^{\frac{3}{2}}} - U \frac{q(ps+qt)}{(1+p^2+q^2)^{\frac{3}{2}}}.$$

Hence $K \equiv Z \cdot \frac{\partial \cdot P}{\partial x} - \frac{\partial \cdot Q}{\partial y} = 0$ becomes

$$\frac{\partial U}{\partial z} (1+p^2+q^2)^2 + \lambda \frac{\partial W}{\partial z} (1+p^2+q^2)^{\frac{3}{2}} - \left(\frac{\partial U}{\partial x} + \frac{\partial U}{\partial z} p\right) p(1+p^2+q^2) - \left(\frac{\partial U}{\partial y} + \frac{\partial U}{\partial z} q\right) q(1+p^2+q^2) - U\{(1+p^2)t - 2pqs + (1+q^2)r\} = 0,$$

i.e. $\lambda \frac{\partial W}{\partial z} (1+p^2+q^2)^{\frac{3}{2}} + \left(\frac{\partial U}{\partial z} - p \frac{\partial U}{\partial x} - q \frac{\partial U}{\partial y}\right) (1+p^2+q^2) = U[(1+p^2)t - 2pqs + (1+q^2)r];$

$$\therefore \lambda \frac{\partial W}{\partial z} (1+p^2+q^2)^{\frac{3}{2}} + \frac{\partial U}{\partial z} - p \frac{\partial U}{\partial x} - q \frac{\partial U}{\partial y} = U(1+p^2+q^2)^{\frac{1}{2}} \left(\frac{1}{\rho_1} + \frac{1}{\rho_2}\right).$$

If l, m, n be the direction cosines of the normal to the supposititious surface $z = \phi(x, y)$, say, viz. $(\xi - x)/(-p) = (\eta - y)/(-q) = \zeta - z$,

$$l = \frac{-p}{\sqrt{1+p^2+q^2}}, \quad m = \frac{-q}{\sqrt{1+p^2+q^2}}, \quad n = \frac{1}{\sqrt{1+p^2+q^2}},$$

and
$$\frac{1}{\rho_1} + \frac{1}{\rho_2} = \frac{1}{U} \left(l \frac{\partial U}{\partial x} + m \frac{\partial U}{\partial y} + n \frac{\partial U}{\partial z} \right) + \frac{\lambda}{U} \frac{\partial W}{\partial z},$$

and when $\iint U dS$ is unconditionally stationary,

$$\frac{1}{\rho_1} + \frac{1}{\rho_2} = \frac{1}{U} \left(l \frac{\partial U}{\partial x} + m \frac{\partial U}{\partial y} + n \frac{\partial U}{\partial z} \right).$$

If the surface in either case is to terminate in a line on any surface $\psi(x, y, z) = 0$, the bounding condition $(V - l'p - Qq)\psi_z = l'\psi_x + Q\psi_y$ becomes

$$(U + \lambda W \sqrt{1+p^2+q^2})\psi_z = U(p\psi_x + q\psi_y) \quad \text{or} \quad p\psi_x + q\psi_y - \psi_z = \frac{\lambda}{U} W \psi_z,$$

and in the unconditional case $p\psi_x + q\psi_y - \psi_z = 0$, and the surfaces then cut orthogonally at each point of such bounding line or lines.

1566. A Method of Discrimination when the Limits are fixed.

If we consider the case of fixed limits of integration for such an integral as $v = \iint \sqrt{1+p^2+q^2} dx dy$, say from $y = y_0$ to $y = y_1$, and from $x = x_0$ to $x = x_1$, the discrimination between maxima and minima may be conducted as follows, taking such a variation as described in Art 1563.

Suppose z becomes $z + \delta z$ and p, q respectively $p + \delta p$ and $q + \delta q$. Then V becomes $\sqrt{1+(p+\delta p)^2+(q+\delta q)^2}$. This we must expand to terms of the second order, and we have

$$V + \delta V = \sqrt{1+p^2+q^2} \left[1 + \frac{1}{2} \frac{2p \delta p + 2q \delta q + \delta p^2 + \delta q^2}{1+p^2+q^2} - \frac{1}{8} \frac{(2p \delta p + 2q \delta q)^2}{(1+p^2+q^2)^2} + \dots \right];$$

$$\therefore \delta V = \frac{p \delta p + q \delta q}{(1+p^2+q^2)^{\frac{3}{2}}} + \frac{\delta p^2 + \delta q^2 + (p \delta q - q \delta p)^2}{2(1+p^2+q^2)^{\frac{5}{2}}}.$$

Hence the second order variation in δv is

$$\frac{1}{2} \iint \frac{\delta p^2 + \delta q^2 + (p \delta q - q \delta p)^2}{(1+p^2+q^2)^{\frac{5}{2}}} dx dy,$$

which being essentially positive for all variations, the solution of Art. 1559 gives a true *minimum* solution.

1567. Taking the case of Art. 1561, the second order terms in δV are those in $\sqrt{1+(p+\delta p)^2+(q+\delta q)^2} + \lambda(z + \delta z)$, i.e. the same as the above, and are essentially positive. We therefore find a true *minimum* in this case also. We turn, however, to a more detailed consideration of the second order terms in the general case.

1568. Culverwell's Method of Discrimination between Maxima and Minima Values. Reconsideration of the Variations to be given.

In estimating the variation of

$$u \equiv \int_{x_0}^{x_1} V dx, \text{ where } V \equiv \phi\{x, y, y', y'', \dots y^{(n)}\},$$

we have so far given to each letter, inclusive of x , an arbitrary change, so that the point x, y is displaced to $x + \delta x, y + \delta y$; and the direction of the path, its curvature and higher order peculiarities, indicated by y', y'' and higher order differential coefficients, have also undergone arbitrary variations and become $y' + \delta y', y'' + \delta y''$, etc.

Many writers prefer to keep x unaltered, and to vary y and its differential coefficients alone (see Art. 1563).

Considerable simplification results in taking δx to be zero. For then we have $\omega = \delta y, \omega' = \delta y', \omega'' = \delta y''$, etc., instead of the more cumbrous expressions $\delta y - y' \delta x, \delta y' - y'' \delta x, \delta y'' - y''' \delta x$, etc., for which they respectively stand. But there is this disadvantage, that when in an investigation δx has once been taken to be zero it cannot be restored at a later stage, whilst if we retain the variation of x from the beginning we can at any time make it zero. And in dealing with the terminal conditions, these terminals are not in general compelled to move upon lines parallel to the y -axis, but may lie on specific curves in which δx necessarily varies with δy , and it has therefore been so far convenient to retain command of the variation of x as well as over those of the other letters.

1569. To make $\delta x = 0$ throughout clearly means that the deformation chosen of the hypothetical curve which represents a relation between y and x , is one which is obtained by an arbitrary point to point variation of each ordinate. That is, each point is displaced parallel to the y -axis, through an arbitrary small distance *with consequent alterations* in the values of the differential coefficients of y , which depend upon the particular variations arbitrarily assigned from point to point to the ordinates. That is, taking $y = \chi(x)$ to be a supposititious relation between x and y , which we are to test as to the possibility of its giving a stationary value to $\int V dx$ between the limits $x = x_0$ and $x = x_1$, then $y = \chi(x) + \epsilon \theta(x)$,

where ϵ is an infinitesimal constant not containing x , and $\theta(x)$ is an arbitrary function of x understood to be finite for the whole range of integration, would be the equation of a contiguous curve to $y=\chi(x)$, and such that the variation of y at any point is $\delta y \equiv \epsilon \theta(x)$. We shall write χ and θ for $\chi(x)$ and $\theta(x)$ respectively for short; and we shall take θ to have been chosen so that neither it nor any of its differential coefficients up to the $(n-1)^{\text{th}}$ becomes infinite or discontinuous, but that they each remain either zero or finite throughout the whole range of integration. Then as ϵ is taken independent of x , $\delta y' = \epsilon \theta'$, $\delta y'' = \epsilon \theta''$, $\delta y''' = \epsilon \theta'''$, ... $\delta y^{(n-1)} = \epsilon \theta^{(n-1)}$ and $\delta y^{(n)} = \epsilon \theta^{(n)}$.

But with regard to the last of these, viz. $\epsilon \theta^{(n)}$, we reserve to ourselves the right to make an abrupt change in the value we choose for it, provided such change be from one finite value to another finite value. With this supposition all the differentiations performed are valid operations, all the functions *differentiated* being finite and continuous real functions of x between the limits of the integration.

1570. With such a system of increments, V is changed to

$$V + \delta V = \phi\{x, y + \epsilon\theta, y' + \epsilon\theta', y'' + \epsilon\theta'', \dots, y^{(n)} + \epsilon\theta^{(n)}\};$$

and assuming V to be such that we may use Taylor's Theorem, we have

$$V + \delta V = V + \epsilon \Delta V + \frac{\epsilon^2}{2!} \Delta^2 V + \frac{\epsilon^3}{3!} R,$$

where $\Delta \equiv \theta \frac{\partial}{\partial y} + \theta' \frac{\partial}{\partial y'} + \dots + \theta^{(n)} \frac{\partial}{\partial y^{(n)}}$, and $\frac{\epsilon^3}{3!} R$ is the "Remainder" after three terms. This expansion involves the assumption that all the Partial Differential Coefficients of V of the first and second orders with regard to $y, y', y'', \dots, y^{(n)}$ are finite and continuous functions for values of $y, y', \text{etc.}$, within the ranges from $y, y', \text{etc.}$, respectively to $y + \epsilon\theta, y' + \epsilon\theta', \text{etc.}$, for all values of x which lie within the limits of integration of the integral $\int V dx$, i.e. from x_0 to x_1 .

Now x being taken as not subject to variation, we have

$$\delta \int V dx = \int \delta V dx = \epsilon \int (\Delta V) dx + \frac{\epsilon^2}{2!} \int (\Delta^2 V) dx + \frac{\epsilon^3}{3!} \int R dx,$$

and by taking ϵ sufficiently small each of the terms on the right-hand side may be made greater than the sum of all that

follow it. Hence, so long as $\int(\Delta V)dx$ does not vanish, the sign of $\delta \int Vdx$ can be made to change by changing the sign of ϵ . Therefore the primary condition for a maximum or a minimum value is that $\int(\Delta V)dx$ should vanish, the limits being the same as those of the integral $\int Vdx$.

$$\text{Now } \Delta V \equiv \left(\theta \frac{\partial V}{\partial y} + \theta' \frac{\partial V}{\partial y'} + \theta'' \frac{\partial V}{\partial y''} + \dots + \theta^{(n)} \frac{\partial V}{\partial y^{(n)}} \right),$$

where θ itself is arbitrary. And this will be recognised as what the expression $Y_{\omega} + Y_{\omega'} + Y_{\omega''} + \dots$ of Art. 1495 becomes upon putting $\delta x = 0$ therein.

By integration by parts, as in Art. 1496,

$$\int(\Delta V)dx = [\bar{Y}\theta + \bar{Y}_\theta' + \dots + \bar{Y}_{(n)}\theta^{(n-1)}] + \int \bar{Y}\theta dx,$$

the term $V\delta x$ not now appearing in the limit terms, as $\delta x = 0$.

Now let us take one variation between the two points (x_0, y_0) and (x_1, y_1) to be such that *at each terminal the values of $x, y, y', y'', \dots, y^{(n-1)}$ are the same for the varied curve $y = \chi + \epsilon\theta$ as for the supposititious curve $y = \chi$ itself.* That is, suppose the two curves to have contact of the $(n-1)^{\text{th}}$ order at the terminals. Then $\delta y, \delta y', \dots, \delta y^{(n-1)}$ all vanish at the terminals, and therefore also $\theta, \theta', \theta'', \dots, \theta^{(n-1)}$ all vanish at the terminals.

Therefore, with this variation $\int(\Delta V)dx = \int \bar{Y}\theta dx$, and θ being arbitrary from point to point along the path of integration, we must have $Y = 0$ as a necessary condition that $\int(\Delta V)dx$ should vanish. This is the differential equation before obtained, and its solution has been seen to be of the form

$$y = F(x, c_1, c_2, \dots, c_{2n}), \text{ or shortly, } y = F, \text{ say,}$$

in which we may suppose that the several constants occurring have been found as heretofore explained by aid of the terminal conditions existing, and their values inserted. This relation is that for which the integral $\int Vdx$ assumes a stationary value, and the graph is called a stationary curve. This value of y

and those of its differential coefficients may now be substituted in V .

1571. The variation of the integral now reduces to

$$\delta \int_{x_0}^{x_1} V dx = \frac{\epsilon^2}{2!} \int_{x_0}^{x_1} (\Delta^2 V) dx + \frac{\epsilon^3}{3!} \int_{x_0}^{x_1} R dx,$$

in which we are to consider a variation *from the stationary curve*, the supposititious curve $y = \chi(x)$ having been discovered to be of the now known form $y = F$.

As before, if we take ϵ sufficiently small the sign of $\frac{\epsilon^2}{2!} \int_{x_0}^{x_1} (\Delta^2 V) dx$ governs the sign of the right-hand side of the equation, so that the variation $\delta \int_{x_0}^{x_1} V dx$ is positive or negative according as $\int_{x_0}^{x_1} (\Delta^2 V) dx$ is positive or negative for all sufficiently small values of ϵ of whatever sign.

Therefore if $\int_{x_0}^{x_1} (\Delta^2 V) dx$ be positive, $\int_{x_0}^{x_1} V dx$ is increased by such a variation from the stationary curve, and if negative, decreased. It follows, therefore, that the stationary curve $y = F$ gives a maximum or a minimum value to $\int_{x_0}^{x_1} V dx$ according as $\int_{x_0}^{x_1} (\Delta^2 V) dx$ is negative or positive. We therefore have to examine the second order terms $\int_{x_0}^{x_1} (\Delta^2 V) dx$.

1572. In the following examination of the second order terms, we shall follow the method given by Mr. E. P. Culverwell in Vol. XXIII. of the *Proc. of the Lond. Math. Soc.*, 1892. It is only possible to give here a very abridged account of the results arrived at in Mr. Culverwell's researches, and his paper should be read carefully by the advanced student. Various modifications of his notation and procedure are necessarily adopted here to bring the discussion into line with previous work, but the main course of his work is adhered to.

1573. Such a variation of a path $y = \chi$ between two specific terminals P and Q , as has been described in Art. 1570, having contact of the $(n-1)^{\text{th}}$ order with $y = \chi$ at the terminals, so that $\theta = \theta' = \theta'' = \dots = \theta^{(n-1)} = 0$ at P , and at Q , is said to be a

“fixed limit” variation, and is a legitimate variation, provided the conditions for the existence and continuity of the several differential coefficients and the validity of Taylor’s Theorem are not violated.

1574. “Short Range” Variation.

Let $APCQB$ be any path $y=\chi$, and let $PC'Q$ be a “fixed limit” variation of the portion PCQ . Let the abscissae of P and Q be ξ_0 and ξ_1 respectively ($\xi_1 > \xi_0$), and let ξ be the abscissa of an intermediate point C on the arc PCQ . Then

$$\int_{\xi_0}^{\xi} \theta^{(p)}(x) dx = [\theta^{(p-1)}(x)]_{\xi_0}^{\xi} = \theta^{(p-1)}(\xi) - \theta^{(p-1)}(\xi_0) = \theta^{(p-1)}(\xi),$$

where $n \neq p > 0$, for by the condition of Art. 1573, $\theta^{(p-1)}(\xi_0) = 0$.

If then the greatest numerical value of $\theta^{(p)}(x)$ in the range ξ_0 to ξ be called ρ , which is by supposition finite, we have $\theta^{(p-1)}(\xi) \leq (\xi - \xi_0)\rho$, and therefore $\leq (\xi_1 - \xi_0)\rho$, and if we take a very short range from P

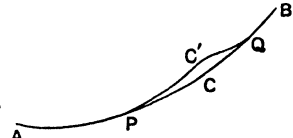

Fig. 451.

to Q , $\xi_1 - \xi_0$ may be made as small as we please. Hence the numerical value of each of the quantities $\theta, \theta', \theta'', \dots, \theta^{(n-1)}, \theta^{(n)}$, may in such short range be regarded as indefinitely small in comparison with the next in order. Therefore $\theta, \theta', \theta'', \dots, \theta^{(n-1)}$ are all negligible in comparison with the last variation $\theta^{(n)}$ for a “short fixed limit” variation.

Now $\Delta^2 V \equiv \left(\theta \frac{\partial}{\partial y} + \theta' \frac{\partial}{\partial y'} + \dots + \theta^{(n)} \frac{\partial}{\partial y^{(n)}} \right)^2 V$, and for such a variation reduces to $(\theta^{(n)})^2 \frac{\partial^2 V}{\partial (y^{(n)})^2}$.

Hence for this short variation,

$$\delta \int V dx = \frac{\epsilon^2}{2!} \int (\theta^{(n)})^2 \frac{\partial^2 V}{\partial (y^{(n)})^2} dx + \frac{\epsilon^3}{3!} \int R dx,$$

and $\theta^{(n)}$ occurs with an even power, so that if $\frac{\partial^2 V}{\partial (y^{(n)})^2} dx$ retains one sign within these short limits from P to Q , $\delta \int V dx$ is positive or negative according as $\frac{\partial^2 V}{\partial (y^{(n)})^2} dx$ is positive or

negative throughout that range when ϵ is taken sufficiently small.

Now, considering the *finite* range from $x=x_0$ to $x=x_1$, the integral $\int_{x_0}^{x_1} V dx$ could not have a maximum for this range unless $\frac{\partial^2 V}{\partial (y^{(n)})^2} dx$ remained negative *throughout the whole range* from $x=x_0$ to $x=x_1$, nor a minimum unless $\frac{\partial^2 V}{\partial (y^{(n)})^2} dx$ remained positive *throughout* the same range. For suppose that there be a small portion of the range from x_0 to x_1 , say from ξ_0 to ξ_1 , in which $\frac{\partial^2 V}{\partial (y^{(n)})^2} dx$ has ceased to be negative and become positive.

We could then take a "short range fixed limit" variation from P where $x=\xi_0$, to Q where $x=\xi_1$, without any variation at all for other parts of the stationary curve from x_0 to x_1 . Then for this short range variation,

$$\delta \int_{\xi_0}^{\xi_1} V dx = \frac{\epsilon^2}{2!} \int_{\xi_0}^{\xi_1} (\theta^{(n)})^2 \frac{\partial^2 V}{\partial (y^{(n)})^2} dx + \frac{\epsilon^3}{3!} \int_{\xi_0}^{\xi_1} R dx,$$

and for the rest of the range from x_0 to x_1 there is no variation; therefore $\delta \int_{x_0}^{x_1} V dx$ for the whole range is positive *for such a variation*, and the condition for a maximum is that it shall be negative. Hence, unless $\frac{\partial^2 V}{\partial (y^{(n)})^2} dx$ retains a negative sign *for the whole range* from x_0 to x_1 , a maximum value of $\int_{x_0}^{x_1} V dx$ cannot occur. Similarly a minimum could not occur if $\frac{\partial^2 V}{\partial (y^{(n)})^2} dx$, starting with a positive value, became negative for part of the range.

Hence, *supposing that in the whole range from $A(x=x_0)$ to $B(x=x_1)$, x increasing throughout, there is no point at which $\int_{x_0}^x (\Delta^2 V) dx$ vanishes*, small short range variations such as that just described from the point P to the point Q upon it can be supposed to be made, and if in each of these $\frac{\partial^2 V}{\partial (y^{(n)})^2} dx$ retains the same sign, $\int_{x_0}^{x_1} V dx$ will have a maximum or a minimum

value according as that sign is negative or positive, remaining so throughout the whole range of integration.

1575. It will be noted that in the above statement we have written $\frac{\partial^2 V}{\partial (y^{(n)})^2} dx$, including the dx as a factor, because if in the case when in travelling from A to B we pass a point C at which the tangent to the path is parallel to the y -axis, and x increases up to a certain amount, viz. the abscissa of C , and then decreases on approaching B , dx itself in such cases changes sign. Hence also in such cases $\frac{\partial^2 V}{\partial (y^{(n)})^2}$ must for a maximum or minimum also change sign at C in order to preserve an invariable sign in $\frac{\partial^2 V}{\partial (y^{(n)})^2} dx$ throughout the path.

We have now to consider the stipulation that *there shall be no point between A and B , say with abscissa X , at which $\int_{x_0}^X \Delta^2 V dx$ vanishes.*

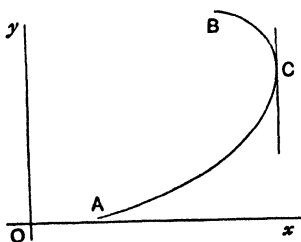

Fig. 452.

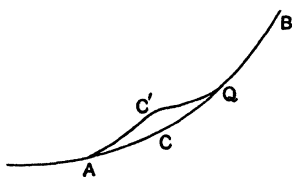

Fig. 453.

1576. **Conjugate Points on a Stationary Curve.**

Let A, Q be two points on a stationary path $ACQB$.

Then, if Q be the *first* point along the arc for which it is possible to draw a contiguous fixed limit variation $AC'Q$, which is itself also stationary, the points A, Q are said to be 'conjugate' to each other.

If both paths be stationary, we must have $\delta \int V dx = 0$ to the first order along each, and therefore each must be a solution of the same differential equation $\bar{Y} = 0$. Therefore, if the curve ACQ have the equation $y = F(x, c_1, c_2, \dots, c_{2n})$, the varia-

tion $AC'Q$ must have an equation of the same form, and the corresponding ordinate may be written

$$y + \delta y = F(x, c_1 + \delta c_1, c_2 + \delta c_2, \dots, c_{2n} + \delta c_{2n}),$$

so that
$$\delta y = \frac{\partial y}{\partial c_1} \delta c_1 + \frac{\partial y}{\partial c_2} \delta c_2 + \dots + \frac{\partial y}{\partial c_{2n}} \delta c_{2n}.$$

Differentiating this $(n-1)$ times with regard to n ,

$$\delta y' = \frac{\partial y'}{\partial c_1} \delta c_1 + \frac{\partial y'}{\partial c_2} \delta c_2 + \dots + \frac{\partial y'}{\partial c_{2n}} \delta c_{2n},$$

etc.,

$$\delta y^{(n-1)} = \frac{\partial y^{(n-1)}}{\partial c_1} \delta c_1 + \frac{\partial y^{(n-1)}}{\partial c_2} \delta c_2 + \dots + \frac{\partial y^{(n-1)}}{\partial c_{2n}} \delta c_{2n}.$$

Now $\delta y, \delta y', \dots, \delta y^{(n-1)}$ are to vanish at $A(x_0, y_0)$ and also at $Q(x, y)$. Hence we obtain by elimination of $\delta c_1, \delta c_2, \dots, \delta c_{2n}$ between the $2n$ equations arising, a determinant with $2n$ rows and columns, viz.

$$\begin{vmatrix} \frac{\partial y}{\partial c_1}, & \frac{\partial y}{\partial c_2}, & \dots & \frac{\partial y}{\partial c_{2n}} \\ \dots & \dots & \dots & \dots \\ \frac{\partial y^{(n-1)}}{\partial c_1}, & \frac{\partial y^{(n-1)}}{\partial c_2}, & \dots & \frac{\partial y^{(n-1)}}{\partial c_{2n}} \\ \left(\frac{\partial y}{\partial c_1}\right)_0, & \left(\frac{\partial y}{\partial c_2}\right)_0, & \dots & \left(\frac{\partial y}{\partial c_{2n}}\right)_0 \\ \dots & \dots & \dots & \dots \\ \left(\frac{\partial y^{(n-1)}}{\partial c_1}\right)_0, & \left(\frac{\partial y^{(n-1)}}{\partial c_2}\right)_0, & \dots & \left(\frac{\partial y^{(n-1)}}{\partial c_{2n}}\right)_0 \end{vmatrix} = 0,$$

in which the first n rows, without suffix, denote the values at $Q, (x, y)$, and the second n rows, with suffix $_0$, denote the values at $A, (x_0, y_0)$.

This equation determines x in terms of x_0 . That is, it gives the various points Q on the first stationary curve $ACQB$, starting from A , to which it is possible to draw a contiguous fixed limit curve $AC'Q$, which is also stationary. And the first of the points Q which satisfies this condition is the point conjugate to A .

1577. Now let a point P (abscissa X) travel along the curve AB from $A(x_0, y_0)$ towards $B(x_1, y_1)$, the curve being a stationary one for $\int V dx$. Then we have seen that for this curve to give a *maximum value* to the integral, it is a primary

necessary condition that $\frac{\partial^2 V}{\partial (y^{(n)})^2} dx$ should be negative for all values of x from A to B .

We shall show that as P travels along AB , the point conjugate to A is also the first position of P for which

$$\int_{x_0}^x \Delta^2 V dx = 0.$$

Take a position of P very near A and connect AB by a "short range fixed limit" variation $AQPDB$ having contact

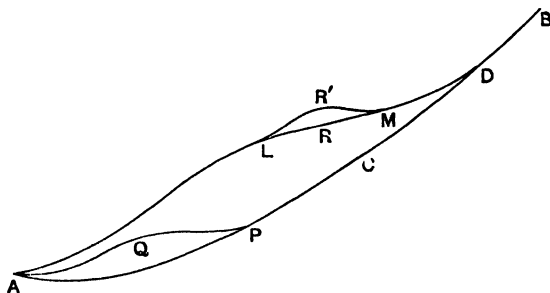

Fig. 454.

of the $(n-1)^{\text{th}}$ order with the stationary curve at A and at P , and coinciding with it from P to B . Then, for this variation

$$\delta \int_{x_0}^{x_1} V dx = \delta \int_{x_0}^x V dx = \frac{\epsilon^2}{2!} \int_{x_0}^x \Delta^2 V dx + \frac{\epsilon^3}{3!} \int_{x_0}^x R dx,$$

and over the short range x_0 to X , $\Delta^2 V$ is replaceable by $\frac{\partial^2 V}{\partial (y^{(n)})^2}$, which is of necessity negative, and therefore within this short range $\int_{x_0}^{x_1} V dx$ is decreased by the variation whatever be the sign of ϵ when sufficiently small. Therefore $\frac{\partial^2 V}{\partial (y^{(n)})^2} dx$ negative is a *sufficient* condition that the stationary path should yield a *maximum* value to $\int V dx$ for this short range.

Now let P travel onwards towards B . Then, $\Delta^2 V$ being by supposition a *finite and continuous* function of x , it cannot change sign except by passing through a zero value. Suppose that $\Delta^2 V$, which started from A as a negative quantity, retains that sign until P arrives at a point C on the stationary curve

AB , and that at C , $\Delta^2 V=0$, and beyond C that $\Delta^2 V$ becomes positive. Then $\int \Delta^2 V dx$ from A to C is a negative quantity. Suppose now that P travels beyond C to a point D such that $\int \Delta^2 V=0$ when the integration is from A to D , the positive values of the integrand which accrue beyond C having cancelled the aggregate of the negative values occurring before arrival at C . Take a "fixed limit" variation connecting A and D , viz. $ARDB$, having $(n-1)^{\text{th}}$ order contact with the stationary curve $ACDB$ at A and at D , and coinciding with it from D to B . Let X be now the abscissa of D . Then

$$\delta \int_{x_0}^{x_1} V dx = \delta \int_{x_0}^X V dx = \frac{\epsilon^2}{2!} \int_{x_0}^X \Delta^2 V dx + \frac{\epsilon^3}{3!} \int_{x_0}^X R dx = \frac{\epsilon^3}{3!} \int_{x_0}^X R dx,$$

and therefore vanishes to the second order of infinitesimals. Hence to that order

$$\begin{aligned} \int V dx \text{ for the fixed limit variation } ARDB \\ = \int V dx \text{ for the stationary path } APDB. \end{aligned}$$

It will follow that $ARDB$ is itself also a stationary path from A to D .

For if any short portion of it, say LRM , were not of stationary character, we could connect RM by a stationary short-range fixed limit path $LR'M$, and therefore

$$\int V dx \text{ (for } LR'M) > \int V dx \text{ (for } LRM);$$

$$\therefore \int V dx \text{ (for } ALR'MDB) > \int V dx \text{ (for } ALRMD),$$

and $\therefore > \int V dx \text{ (for } APDB),$

and this would necessitate $\int \Delta^2 V dx$ becoming positive between A and D , which is contrary to the hypothesis that D is the first point for which the integral ceases to be negative. Therefore the variation $ALRMD$ must itself be a stationary curve between A and D , and D is itself the point conjugate to A .

Since $\int_{x_0}^x \Delta^2 V dx$ is negative so long as $x < X$, viz. the abscissa of D , $\int_{x_0}^x V dx$ has a maximum value along APD for all values of x which are less than X .

In the same way $\int_{x_0}^x V dx$ has a minimum value for all values of x which are $< X$ if $\Delta^2 V$ be positive at starting from A .

1578. If, however, the conjugate point of A occurs before B is reached, $\int_{x_0}^x V dx$, though stationary, will have neither a maximum nor a minimum, as we shall now show.

Take a short-range fixed limit variation FGH connecting two points, F on $ALRMD$, H on DB having $(n-1)^{\text{th}}$ order contact with these curves at the terminals F and H . Suppose

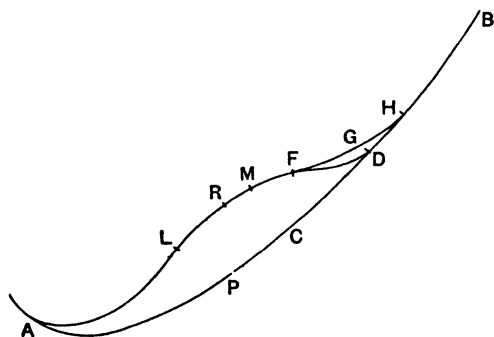

Fig. 455.

this variation to have been selected a stationary curve. Then, since by hypothesis $\frac{\partial^2 V}{\partial (y^{(n)})^2} dx$ is negative, this variation gives a maximum value for $\int V dx$ for that range, and therefore

$$\int V dx \text{ (for } FGH) > \int V dx \text{ (for } FDH).$$

$$\text{Hence } \int V dx \text{ (for } ARFGHB) > \int V dx \text{ (for } ARFDB),$$

$$\text{and therefore } > \int V dx \text{ (for } APDB).$$

Hence $\int V dx$ along $APDB$ would not have a *maximum* value; and it could not have a minimum value, for $\frac{\partial^2 V}{\partial (y^{(n)})^2} dx$ is negative.

Therefore, if the conjugate point to A lies between A and B the stationary path AB gives neither a maximum value nor a minimum value for $\int V dx$ for that range.

We therefore have the following test:

The stationary path AB having been determined, it will yield a maximum or a minimum value for $\int V dx$, according as $\frac{\partial^2 V}{\partial (y^{(n)})^2} dx$ is negative or positive from A to B , provided there be no point conjugate to A lying between A and B . But in case of such point being existent between A and B the stationary curve from A to B yields neither a maximum nor a minimum.

In the case when $\frac{\partial^2 V}{\partial (y^{(n)})^2} dx$ vanishes at a point between A and B , but does not change sign, we could take a short-range fixed limit variation, including the point in question, vanishing to the second order, and the sign of $\delta \int_{x_0}^{x_1} V dx$ for this variation depends on third-order terms, and unless these also vanish for the value of x at the point, the sign of $\delta \int_{x_0}^{x_1} V dx$ could be made to change by changing the sign of ϵ . Hence there would be neither a maximum nor a minimum for such a variation. But for other variations $\int_{x_0}^{x_1} V dx$ has a maximum or a minimum as before.

1579. Illustrative Examples.

(i) Take the case of the integral $\int (y')^2 dx$ of Art. 1502 (3). To find the point conjugate to the point x_0, y_0 on the stationary curve.

The stationary curve is $y = c_0 + c_1 x + \frac{1}{2!} c_2 x^2 + \frac{1}{3!} c_3 x^3$.

Here $\delta y = \delta c_0 + x \delta c_1 + \frac{1}{2!} x^2 \delta c_2 + \frac{1}{3!} x^3 \delta c_3$, $\delta y' = \delta c_1 + x \delta c_2 + \frac{1}{2!} x^2 \delta c_3$, and these are to vanish at (x_0, y_0) and at (x, y) . Hence the point conjugate to (x_0, y_0) is given by

$$\left| \begin{array}{cccc} 1, & x, & \frac{1}{2!}x^2, & \frac{1}{3!}x^3 \\ 0, & 1, & x, & \frac{1}{2!}x^2 \\ 1, & x_0, & \frac{1}{2!}x_0^2, & \frac{1}{3!}x_0^3 \\ 0, & 1, & x_0, & \frac{1}{2!}x_0^2 \end{array} \right| = 0, \text{ that is } \frac{1}{2}(x-x_0)^4 = 0, \\ \text{and } x=x_0 \text{ is the only solution.}$$

Hence, in this case, there is *no* point on the stationary curve which is conjugate to any other.

We also have $V=y'^2$ and $\frac{\partial^2 V}{\partial y'^2}=2$, which, being positive, the stationary curve gives a true *minimum* value to $\int y'^2 dx$ for any selected portion of the curve.

(ii) In *Ex. 1 of Art. 1502, viz. the shortest distance between two points*, $V=\sqrt{1+y'^2}$, $\Delta \equiv \theta' \frac{\partial}{\partial y'}$, $\frac{\partial^2 V}{\partial y'^2} = \frac{\partial}{\partial y'} \frac{y'}{\sqrt{1+y'^2}} = \frac{1}{(1+y'^2)^{\frac{3}{2}}}$, and is essentially positive. And there is obviously no point conjugate to any other on the locus $y=c_0+c_1x$, which is the solution of $\Delta V=0$. The solution arrived at is therefore a true *minimum* solution, as is obvious of course from the nature of the case.

1580. The Case of two or more Dependent Variables.

Resuming the discussion in Art. 1508 for the case

$$V \equiv F \left\{ x, y, y', y'', \dots y^{(n)}, z, z', z'', \dots z^{(m)} \right\},$$

and taking $\epsilon_1\theta$, $\epsilon_2\phi$ as the fundamental variations of y and z , we have, upon putting $\delta x=0$,

$$\eta = \delta y = \epsilon_1\theta, \quad \eta' = \epsilon_1\theta', \quad \eta'' = \epsilon_1\theta'' \text{ etc.},$$

$$\xi = \delta z = \epsilon_2\phi, \quad \xi' = \epsilon_2\phi', \quad \xi'' = \epsilon_2\phi'' \text{ etc.},$$

and taking $\Delta_1 \equiv \theta \frac{\partial}{\partial y} + \theta' \frac{\partial}{\partial y'} + \dots + \theta^{(n)} \frac{\partial}{\partial y^{(n)}}$,

$$\Delta_2 = \phi \frac{\partial}{\partial z} + \phi' \frac{\partial}{\partial z'} + \dots + \phi^{(m)} \frac{\partial}{\partial z^{(m)}},$$

$$\delta \int V dx = [H] + \int (\bar{Y}\epsilon_1\theta + \bar{Z}\epsilon_2\phi) dx + \frac{1}{2!} \int (\epsilon_1\Delta_1 + \epsilon_2\Delta_2)^2 V dx + \frac{1}{3!} \int R dx,$$

and the general forms of y and z are determinable from the differential equations $\bar{Y}=0$ and $\bar{Z}=0$, and the constants involved obtainable from $[H]=0$ as before explained. And

the same theorems hold as in the case of one independent variable. But the second-order variation will in its highest differential coefficients become

$$\frac{1}{2!} \int \left\{ \epsilon_1^2 (\theta^{(n)})^2 \frac{\partial^2 V}{\partial (y^{(n)})^2} + 2\epsilon_1 \epsilon_2 \theta^{(n)} \phi^{(m)} \frac{\partial^2 V}{\partial y^{(n)} \partial z^{(m)}} + \epsilon_2^2 (\phi^{(m)})^2 \frac{\partial^2 V}{\partial (z^{(m)})^2} \right\} dx,$$

in which the integrand is of the form

$$r\epsilon_1^2 (\theta^{(n)})^2 + 2s\epsilon_1 \epsilon_2 \theta^{(n)} \phi^{(m)} + t\epsilon_2^2 (\phi^{(m)})^2;$$

and, as in *D. C.*, Art. 497, the condition for an invariable sign is that $rt - s^2$ shall be positive, and the sign in question will be that of r or of t , for since $rt - s^2$ is to be positive, r and t must have the same sign.

Thus it will be essential that $\frac{\partial^2 V}{\partial (y^{(n)})^2} \cdot \frac{\partial^2 V}{\partial (z^{(m)})^2} - \left\{ \frac{\partial^2 V}{\partial (y^{(n)}) \partial z^{(m)}} \right\}^2$ shall be positive, and for a maximum we must have $\frac{\partial^2 V}{\partial (y^{(n)})^2}$ negative, and for a minimum, positive.

1581. The case $rt = s^2$ in general necessitates an examination of the terms of $(\epsilon_1 \Delta_1 + \epsilon_2 \Delta_2)^2 V$, which contain lower order differentials. This case is discussed by Mr. Culverwell in the paper cited above, to which the reader is referred.

The method employed in the last article is clearly applicable if there be more dependent variables than two. Following the same method as before, the second-order variation takes a form similar to that discussed in Art. 502, *Diff. Calc.*, with an exactly similar result.

1582. Relative Maxima and Minima.

It has been explained that when we are to search for the maximum or minimum value of $v \equiv \int V dx$, with condition $w \equiv \int W dx = a$ given constant, say a , we are to treat $\int (V + \lambda W) dx$ as an unconditional maximum or minimum, and we get

$$\begin{aligned} \delta(v + \lambda w) &\equiv \delta \int (V + \lambda W) dx = \int (\delta V + \lambda \delta W) dx \\ &= \epsilon \int (\Delta V + \lambda \Delta W) dx + \frac{\epsilon^2}{2!} \int (\Delta^2 V + \lambda \Delta^2 W) dx + \frac{\epsilon^3}{3!} \int R dx, \end{aligned}$$

and with the same precautions as before with regard to choice of legitimate variations which will not violate conditions of continuity in the several differential coefficients, and which will ensure the validity of Taylor's expansion, the terms of first order having been made to vanish as a primary condition for a maximum or minimum, we have $\int(\Delta V + \lambda \Delta W) dx = 0$, an equation already arrived at in Art. 1504; and then

$$\delta(v + \lambda w) = \frac{\epsilon^2}{2!} \int (\Delta^2 V + \lambda \Delta^2 W) dx + \frac{\epsilon^3}{3!} \int R dx,$$

and the terms of the highest order in the integrand $\Delta^2 V + \lambda \Delta^2 W$ are all we require in the discrimination between maxima and minima. These terms are $\frac{\partial^2 V}{\partial (y^{(n)})^2} + \lambda \frac{\partial^2 W}{\partial (y^{(n)})^2}$, and for a maximum this expression must be negative throughout the whole range of integration, and for a minimum, positive. In case of the existence of a point conjugate to (x_0, y_0) , such as D of Art. 1577 on the stationary path, with abscissa X , lying between the limits of integration, the variations chosen must be such as to make $\delta \int_{x_0}^X W dx$ zero. For (see Fig. 455) beyond the point D the variation $\delta \int_X^{x_1} W dx$ has been taken as zero. Therefore λ must be such that $\int_{x_0}^X W dx$ along the stationary fixed limit variation $ALRD$ has the same value as $\int_{x_0}^{x_1} W dx$ along the original stationary curve $APCDB$, for which in general the value of λ is different.

The equation to find the position of the conjugate point is therefore modified by the introduction of λ .

The equation of the stationary path is now of the form $y = \chi(x, \lambda, c_1, c_2, \dots c_{2n})$. If, upon substitution of this value of y and its several differential coefficients we get

$$w \equiv \int_{x_0}^{x_1} W dx \equiv F(x_0, x_1, \lambda, c_1, c_2, \dots c_{2n}) = a,$$

upon variation of the constants we get the additional equation

$$\frac{\partial F}{\partial \lambda} \delta \lambda + \frac{\partial F}{\partial c_1} \delta c_1 + \frac{\partial F}{\partial c_2} \delta c_2 + \dots + \frac{\partial F}{\partial c_{2n}} \delta c_{2n} = 0,$$

and the equations arising from the vanishing of $\delta y, \delta y'$,

$\delta y'', \dots \delta y^{(n-1)}$ at (x_0, y_0) and at its conjugate, which are now altered by the presence of λ to

$$\left. \begin{aligned} \frac{\partial y}{\partial \lambda} \delta \lambda + \frac{\partial y}{\partial c_1} \delta c_1 + \frac{\partial y}{\partial c_2} \delta c_2 + \dots + \frac{\partial y}{\partial c_{2n}} \delta c_{2n} &= 0, \\ \frac{\partial y'}{\partial \lambda} \delta \lambda + \frac{\partial y'}{\partial c_1} \delta c_1 + \frac{\partial y'}{\partial c_2} \delta c_2 + \dots + \frac{\partial y'}{\partial c_{2n}} \delta c_{2n} &= 0, \\ &\text{etc.}, \\ \frac{\partial y^{(n-1)}}{\partial \lambda} \delta \lambda + \frac{\partial y^{(n-1)}}{\partial c_1} \delta c_1 + \frac{\partial y^{(n-1)}}{\partial c_2} \delta c_2 + \dots + \frac{\partial y^{(n-1)}}{\partial c_{2n}} \delta c_{2n} &= 0, \end{aligned} \right\} \begin{array}{l} \text{true at} \\ (x_0, y_0) \\ \text{and its} \\ \text{conjugate} \\ (x, y). \end{array}$$

These $2n+1$ equations give, upon the elimination of $\delta \lambda, \delta c_1, \delta c_2, \dots \delta c_{2n}$,

$$\begin{vmatrix} \frac{\partial y}{\partial \lambda}, & \frac{\partial y}{\partial c_1}, & \frac{\partial y}{\partial c_2}, & \dots & \frac{\partial y}{\partial c_{2n}} \\ \frac{\partial y'}{\partial \lambda}, & \frac{\partial y'}{\partial c_1}, & \frac{\partial y'}{\partial c_2}, & \dots & \frac{\partial y'}{\partial c_{2n}} \\ \dots & \dots & \dots & \dots & \dots \\ \frac{\partial y^{(n-1)}}{\partial \lambda}, & \frac{\partial y^{(n-1)}}{\partial c_1}, & \frac{\partial y^{(n-1)}}{\partial c_2}, & \dots & \frac{\partial y^{(n-1)}}{\partial c_{2n}}, \\ \left(\frac{\partial y}{\partial \lambda}\right)_0, & \left(\frac{\partial y}{\partial c_1}\right)_0, & \left(\frac{\partial y}{\partial c_2}\right)_0, & \dots & \left(\frac{\partial y}{\partial c_{2n}}\right)_0, \\ \dots & \dots & \dots & \dots & \dots \\ \left(\frac{\partial y^{(n-1)}}{\partial \lambda}\right)_0, & \left(\frac{\partial y^{(n-1)}}{\partial c_1}\right)_0, & \left(\frac{\partial y^{(n-1)}}{\partial c_2}\right)_0, & \dots & \left(\frac{\partial y^{(n-1)}}{\partial c_{2n}}\right)_0 \\ \frac{\partial F}{\partial \lambda}, & \frac{\partial F}{\partial c_1}, & \frac{\partial F}{\partial c_2}, & \dots & \frac{\partial F}{\partial c_{2n}}, \end{vmatrix} = 0,$$

to determine the position of a point (x, y) on the stationary path conjugate to (x_0, y_0) .

If such a point occurs between the limits $x = x_0$ and $x = x_1$ on the stationary path, this path will give neither a maximum nor a minimum.

1583. When V contains more than one dependent variable, and these dependent variables are connected by an equation $L=0$, viz. the case discussed in Art. 1513, we proceed as there explained with the first-order variation to obtain the stationary solution. In passing to the second-order variation, we have

$$\frac{1}{2!} \int \Delta^2 (V + \lambda L) dx, \text{ where } \Delta \equiv \epsilon_1 \Delta_1 + \epsilon_2 \Delta_2 \text{ (Art. 1580).}$$

where $\epsilon_1 \theta$ and $\epsilon_2 \phi$ are the fundamental variations of y and z , and $\epsilon_1 \theta^{(n)}, \epsilon_2 \phi^{(n)}$ those of $y^{(n)}$ and $z^{(n)}$. We shall suppose

that the orders of the highest differentials occurring in V and L are the same. Then taking as before a short-range variation, the variations $\theta, \theta', \theta'', \dots \theta^{(n-1)}$ may be all neglected in comparison with $\theta^{(n)}$, and $\phi, \phi', \phi'', \dots \phi^{(n-1)}$ in comparison with $\phi^{(n)}$. The only terms of $\Delta^2(V+\lambda L)$ which need be retained are therefore

$$\frac{\partial^2(V+\lambda L)}{\partial(y^{(n)})^2} \epsilon_1^2 (\theta^{(n)})^2 + 2 \frac{\partial^2(V+\lambda L)}{\partial y^{(n)} \partial z^{(n)}} \epsilon_1 \epsilon_2 \theta^{(n)} \phi^{(n)} + \frac{\partial^2(V+\lambda L)}{\partial(z^{(n)})^2} \epsilon_2^2 (\phi^{(n)})^2,$$

where $\theta^{(n)}, \phi^{(n)}$ are not independent but connected by the equation

$$\frac{\partial L}{\partial y^{(n)}} \epsilon_1 \theta^{(n)} + \frac{\partial L}{\partial z^{(n)}} \epsilon_2 \phi^{(n)} = 0,$$

so that
$$\left\{ \frac{\partial^2(V+\lambda L)}{\partial(y^{(n)})^2} \left(\frac{\partial L}{\partial z^{(n)}} \right)^2 - 2 \frac{\partial^2(V+\lambda L)}{\partial y^{(n)} \partial z^{(n)}} \frac{\partial L}{\partial z^{(n)}} \frac{\partial L}{\partial y^{(n)}} + \frac{\partial^2(V+\lambda L)}{\partial(z^{(n)})^2} \left(\frac{\partial L}{\partial y^{(n)}} \right)^2 \right\} dx$$

must retain the same sign throughout the integration if a maximum or a minimum is to occur; and that sign must be negative for a maximum, positive for a minimum.

For details of the case in which the orders of the highest degree differentials in V and L are not the same, the reader is referred to Mr. Culverwell's paper [p. 252, *L. Math. Soc. Proc.*, Vol. XXIII.].

1584. Bibliography.

Readers wishing to pursue the subject of the Calculus of Variations further are referred to Todhunter's *History of the Progress of the Calculus of Variations* during the nineteenth century and *Researches in the Calculus of Variations*, and to the treatises on the subject by Jellett and Strauch. Professor Williamson, in Chapter XV. of his *Integral Calculus*, gives an account of the "Sign of Substitution" used by Sarrus in his Essay, *Recherches sur le Calcul des Variations*, and makes much use of the same. In his Chapter XVII. the student will find much useful information with regard to the bounding variations in the case of a double integral and a discussion of some cases which arise in the treatment of the partial differential equation as well as several other interesting matters. The papers by Culverwell, of which considerable use has been made, should be referred to in *R.S. Trans.*, 1887, and in *Proc. of the Lond. Math. Soc.*, 1891-2. Other writers are Moigno and Lindelöf referred to by Dr. Williamson (*I.C.*, p. 465), Lagrange (*Th. des Fonct.*), Lacroix (*Calc. Int.*, pp. 655-724), Jacobi, Legendre (*Mém. de l'Acad. des Sc.*, 1783), De Morgan (*D. and I. Calc.*, pp. 446-474), Poisson (*Mém. de l'Institut*, T. XII.), Abbott (*Calc. of Var.*), Airy (*Math. Tracts*), Woodhouse (*Isoperimetrical Problems*).

PROBLEMS.

1. Find the stationary value of $\int V dx$, taken between definitely fixed limits, where $V = y'^2 + 2myy' + ny^2$, and discuss its nature.

[LACROIX, *C.I.*, II., p. 721.]

2. Mark out the range of limits on the parabola $(x+a)^2 = 4cy$ between which the integral $\int_{x_0}^{x_1} y \left(\frac{dy}{dx}\right)^{-2} dx$ is a maximum, the range between which it is a minimum, and the range between which it is neither.

[MATH. TRIP., 1890.]

3. The integral $\iint f(x, y, z, p, q) dx dy$ is found to be stationary when taken over the surface $z = \phi(x, y)$; show, by confining the actual variation of z to a small area on this surface, that the variation of the integral cannot always have the same sign within limits specified by a given curve through which the surface must pass, unless $\frac{\partial^2 f}{\partial p^2} \delta p^2 + 2 \frac{\partial^2 f}{\partial p \partial q} \delta p \delta q + \frac{\partial^2 f}{\partial q^2} \delta q^2$ always retains the same sign within these limits, and deduce a criterion for discriminating maxima and minima. Show further that, for a true maximum or minimum, it must not be possible to draw a consecutive surface of stationary character which meets the original one in a closed curve within the given limits. Are these conditions sufficient as well as necessary?

[MATH. TRIP., 1890.]

CHAPTER XXXV. SECTION I.

FORMULAE OF LAGRANGE AND FOURIER.

1585. When a material particle is affected simultaneously by two harmonic oscillations, $a_1 \sin(n_1 t + a_1)$, $a_2 \sin(n_1 t + a_2)$, of the same period $2\pi/n_1$, but their amplitudes a_1 and a_2 and their phases a_1 and a_2 being different, they compound into a single simple harmonic oscillation $A \sin(n_1 t + \alpha)$ of the same period but with amplitude and phase respectively

$$\sqrt{a_1^2 + 2a_1 a_2 \cos(a_1 - a_2) + a_2^2} \quad \text{and} \quad \tan^{-1} \frac{a_1 \sin a_1 + a_2 \sin a_2}{a_1 \cos a_1 + a_2 \cos a_2};$$

and any number of such simple harmonic motions may be compounded in the same way, provided they all have the same periodicity.

Graphically the resultant motion may be represented by constructing the graphs of the several vibrations on the same plan and forming a new graph by the addition of their ordinates. And this always results in an ordinary "curve of sines."

1586. But if the periodicity of the two or more fundamental vibrations be different, as in

$$a_1 \sin(n_1 t + a_1), \quad a_2 \sin(n_2 t + a_2),$$

the above analytical process of composition breaks down but the graphical method still holds, the resulting graph, however, no longer being the simple curve of sines.

Taking for instance as a simple case the graph of

$$\frac{\pi}{4} y = \sin x - \frac{1}{3^2} \sin 3x + \frac{1}{5^2} \sin 5x - \frac{1}{7^2} \sin 7x + \dots,$$

where the periodicities of the constituent vibrations of y are respectively $2\pi/1$, $2\pi/3$, $2\pi/5$, etc., and their amplitudes $4/\pi 1^2$, $4/\pi 3^2$, $4/\pi 5^2$, etc., we

have, from the first three terms only, a figure shown for the extent $x=0$ to $x=\pi/2$ in Fig. 456. And even for three terms of the series it will be

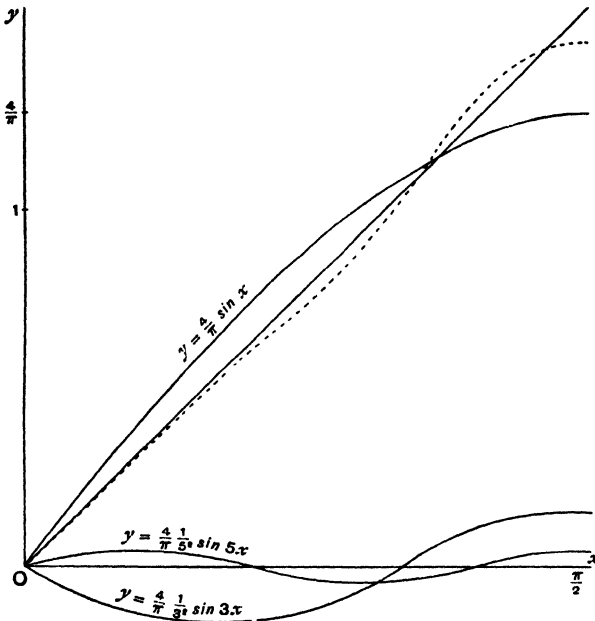

Fig. 456.

seen that the resultant graph is rapidly approximating to a broken system of portions of straight lines parallel to $y=x$ and $y=-x$ alternately, the breaks in the continuity occurring at $x=\pi/2, 3\pi/2, 5\pi/2$, etc.;

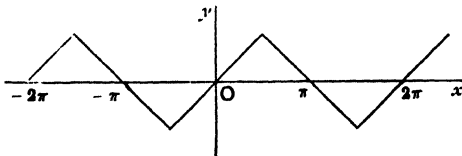

Fig. 457.

and the more terms we take the closer is the approximation to this discontinuous system of lines (Fig. 457).

1587. The Building up of a Function for a Definite Range by Means of Harmonic Elements.

Let us examine then whether it be possible to build up a function of x

viz. $f(x)$, discontinuous as regards its differential coefficients at $x = \pi/2$, $3\pi/2$, $5\pi/2$, ... and equal to

$$-\pi - x, \left(-\frac{3\pi}{2} < x < -\frac{\pi}{2}\right); \quad x, \left(-\frac{\pi}{2} < x < \frac{\pi}{2}\right); \\ \pi - x, \left(\frac{\pi}{2} < x < \frac{3\pi}{2}\right); \quad -2\pi + x, \left(\frac{3\pi}{2} < x < \frac{5\pi}{2}\right); \text{ etc.}$$

Let us assume tentatively that it is expressible as a uniformly convergent series of the form $f(x) \equiv a_0 + \sum_{p=1}^{\infty} (a_p \cos px + b_p \sin px)$, and let us attend to the portion $(-\pi < x < \pi)$.

Then (i) integrating from $-\pi$ to π ,

$$a_0 \cdot 2\pi = \int_{-\pi}^{\pi} f(x) dx = \int_{-\pi}^{-\frac{\pi}{2}} (-\pi - x) dx + \int_{-\frac{\pi}{2}}^{\frac{\pi}{2}} x dx + \int_{\frac{\pi}{2}}^{\pi} (\pi - x) dx = 0.$$

(ii) Multiply by $\cos px$, and integrate from $-\pi$ to π ,

$$a_p \int_{-\pi}^{\pi} \cos^2 px dx = \int_{-\pi}^{-\frac{\pi}{2}} (-\pi - x) \cos px dx + \int_{-\frac{\pi}{2}}^{\frac{\pi}{2}} x \cos px dx + \int_{\frac{\pi}{2}}^{\pi} (\pi - x) \cos px dx \\ = - \left[(\pi + x) \frac{\sin px}{p} + \frac{\cos px}{p^2} \right]_{-\pi}^{-\frac{\pi}{2}} + \left[x \frac{\sin px}{p} + \frac{\cos px}{p^2} \right]_{-\frac{\pi}{2}}^{\frac{\pi}{2}} \\ + \left[(\pi - x) \frac{\sin px}{p} - \frac{\cos px}{p^2} \right]_{\frac{\pi}{2}}^{\pi} = 0; \\ \therefore a_p \pi = 0 \quad \text{and} \quad a_p = 0.$$

(iii) Multiply by $\sin px$, and integrate from $-\pi$ to π ,

$$b_p \int_{-\pi}^{\pi} \sin^2 px dx = - \left[-(\pi + x) \frac{\cos px}{p} + \frac{\sin px}{p^2} \right]_{-\pi}^{-\frac{\pi}{2}} + \left[-x \frac{\cos px}{p} + \frac{\sin px}{p^2} \right]_{-\frac{\pi}{2}}^{\frac{\pi}{2}} \\ + \left[-(\pi - x) \frac{\cos px}{p} - \frac{\sin px}{p^2} \right]_{\frac{\pi}{2}}^{\pi}; \\ \therefore b_p \pi = \frac{4}{p^2} \sin \frac{p\pi}{2};$$

whence

$$f(x) = \sum_{p=1}^{\infty} \frac{4}{p^2} \sin \frac{p\pi}{2} \sin px = \frac{4}{\pi} \left(\sin x - \frac{1}{3^2} \sin 3x + \frac{1}{5^2} \sin 5x - \frac{1}{7^2} \sin 7x + \dots \right).$$

If we write $x + 2n\pi$ for x , each term of the series remains unaltered, and the result is therefore a periodic function with periodicity 2π , which is in conformity with the graph in Figs. 456 and 457.

The series is manifestly convergent for all values of x . Hence we have expressed a discontinuous function of x which takes the value $(-1)^n (x - n\pi)$ from $(2n-1)\frac{\pi}{2}$ to $(2n+1)\frac{\pi}{2}$, n being integral, as a series of sines of odd multiples of x .

1588. Functions consisting essentially of a set of simple harmonic terms are of constant occurrence in problems of Mechanical and Physical Science, e.g. in the vibration of a piano wire, the propagation of a signal along an electric cable, in problems on the flux of heat, or in the motion of a slide valve

whose mode of travel is actuated by a system of linkages, or by a cam driven by a uniformly revolving shaft. Primarily the nature of the problem in such cases as the latter is that of the resolution of a compound motion known to be periodic, or of the function which expresses it, into its simple harmonic constituents.

A graphical method of procedure is sometimes adopted in the analysis of such a given complex periodic vibration into its simple harmonic elements useful for the practical engineer. Such methods may be found described in treatises on advanced practical mathematics. The resolution may also be performed by mechanical means.*

1589. A series of the form $a_0 + \sum_{p=1}^{p=\infty} (a_p \cos px + b_p \sin px)$ may be written as $a_0 + \sum_{p=1}^{\infty} c_p \sin (px + \alpha_p)$, where $c_p^2 = a_p^2 + b_p^2$ and $\tan \alpha_p = a_p/b_p$, in which we have half as many simple harmonics as before, but the phases are different.

That a single-valued finite and continuous function is under certain circumstances, and for a certain range of the variable, expressible by means of such a series is usually known as Fourier's Theorem.

1590. **Extension of the Rules of Art. 1121.**

Taking p, q and n as integers,

$$\begin{aligned} \int_a^{2n\pi+a} \cos px \cos qx \, dx &= \frac{1}{2} \int_a^{2n\pi+a} \{ \cos (p+q)x + \cos (p-q)x \} dx \\ &= \frac{1}{2} \left[\frac{\sin (p+q)x}{p+q} + \frac{\sin (p-q)x}{p-q} \right]_a^{2n\pi+a} = 0, \quad p \neq q, \\ \int_a^{2n\pi+a} \sin px \sin qx \, dx &= \frac{1}{2} \left[-\frac{\sin (p+q)x}{p+q} + \frac{\sin (p-q)x}{p-q} \right]_a^{2n\pi+a} = 0, \quad p \neq q, \\ \int_a^{2n\pi+a} \cos^2 px \, dx &= \frac{1}{2} \int_a^{2n\pi+a} (1 + \cos 2px) dx = n\pi, \\ \int_a^{2n\pi+a} \sin^2 px \, dx &= \frac{1}{2} \int_a^{2n\pi+a} (1 - \cos 2px) dx = n\pi, \\ \int_a^{2n\pi+a} \sin px \cos qx \, dx &= \frac{1}{2} \int_a^{2n\pi+a} \{ \sin (p+q)x + \sin (p-q)x \} dx \\ &= \frac{1}{2} \left[-\frac{\cos (p+q)x}{p+q} - \frac{\cos (p-q)x}{p-q} \right]_a^{2n\pi+a} = 0, \quad p \neq q, \\ \int_a^{2n\pi+a} \sin px \cos px \, dx &= \frac{1}{2} \int_a^{2n\pi+a} \sin 2px \, dx = \frac{1}{4p} \left[-\cos 2px \right]_a^{2n\pi+a} = 0. \end{aligned}$$

* See Castle's *Manual* (pages 448-464); *Modern Instruments*, Messrs. Bell.

1591. We shall assume for the present that we are dealing with a function of x , $f(x)$, which is single-valued, real, finite and continuous and integrable for a range of real values of x from $x=a$ to $x=a+2\pi$; or that if $f(x)$ be unbounded as to the values of which it is capable in that range, that its integral for that range is absolutely convergent. Moreover, we shall assume that $f(x)$ is such that it is possible to find a series of the form $A_0 + \sum_1^{\infty} (A_p \cos px + B_p \sin px)$ which is uniformly convergent, converging to the value $f(x)$ for each value of x within the given range, and that for such series term by term integration is a possible operation. Then the values of the several coefficients may be found as in the particular case of Art. 1587. For we have

$$(i) \int_a^{2\pi+a} f(x) dx = A_0 \int_a^{2\pi+a} dx = 2\pi A_0;$$

$$(ii) \int_a^{2\pi+a} f(x) \cos px dx = A_p \int_a^{2\pi+a} \cos^2 px dx = \pi A_p;$$

$$(iii) \int_a^{2\pi+a} f(x) \sin px dx = B_p \int_a^{2\pi+a} \sin^2 px dx = \pi B_p.$$

Before substituting the values of the several coefficients, write ξ for x in the several integrands.

Then

$$\begin{aligned} f(x) &= \frac{1}{2\pi} \int_a^{2\pi+a} f(\xi) d\xi + \frac{1}{\pi} \sum_{p=1}^{p=\infty} \left\{ \cos px \int_a^{2\pi+a} \cos p\xi f(\xi) d\xi \right. \\ &\quad \left. + \sin px \int_a^{2\pi+a} \sin p\xi f(\xi) d\xi \right\} \\ &= \frac{1}{2\pi} \int_a^{2\pi+a} f(\xi) d\xi + \frac{1}{\pi} \sum_{p=1}^{p=\infty} \int_a^{2\pi+a} f(\xi) \cos p(\xi-x) d\xi. \end{aligned}$$

In the cases $a=0$ and $a=-\pi$, we have respectively

$$f(x) = \frac{1}{2\pi} \int_0^{2\pi} f(\xi) d\xi + \frac{1}{\pi} \sum_{p=1}^{p=\infty} \int_0^{2\pi} f(\xi) \cos p(\xi-x) d\xi, \quad (2\pi > x > 0),$$

and

$$f(x) = \frac{1}{2\pi} \int_{-\pi}^{\pi} f(\xi) d\xi + \frac{1}{\pi} \sum_{p=1}^{p=\infty} \int_{-\pi}^{\pi} f(\xi) \cos p(\xi-x) d\xi, \quad (\pi > x > -\pi).$$

i.e. unless $\xi = x, x \pm 2\pi, x \pm 4\pi, \dots, x \pm 2n\pi$, where n is an integer;

(iii) that in consequence of the last fact, the only cases when the integrand can have a sensible value being in the vicinity of one of the above values of x , we may confine our integration to such limits as will just include such vicinity;

(iv) that when $\xi = x$ or $x \pm 2n\pi$, the denominator becomes $(1-a)^2$, and therefore the integrand tends to an infinite value; but its integral is not necessarily infinite;

(v) that if ξ increases through any small interval to $\xi+h$, then $f(\xi)$ becomes $f(\xi+h) = f(\xi) + hf'(\xi+\theta h)$, where θ is a positive proper fraction, provided $f'(\xi)$ be existent and remains finite throughout the interval ξ to $\xi+h$; and therefore that in that case when h is an infinitesimal, $f(\xi)$ only changes by an infinitesimal amount in the interval.

(vi) Since $a-\beta > 2\pi$, ξ in its march from β to a can only pass through one of the values $x, x \pm 2\pi, x \pm 4\pi, \dots$, and it may not pass through any. But if $a-\beta = 2\pi$, it must either pass through one of these values or start from one and terminate at the next in order of magnitude.

Suppose first that $a-\beta < 2\pi$, and consider one cycle of the values of I, x lying intermediate between β and $\beta+2\pi$.

First let $a > x > \beta$.

Then $\int_{\beta}^a () d\xi = \left\{ \int_{\beta}^{x-\epsilon_1} + \int_{x-\epsilon_1}^{x+\epsilon_2} + \int_{x+\epsilon_2}^a \right\} () d\xi$, where ϵ_1, ϵ_2 are any two selected very small positive quantities. It has been seen that when a ultimately $= 1$, the first and third of these integrals vanish through containing the factor $(1-a)$ in the numerator. Hence

$$I = L_{a \rightarrow 1} \int_{x-\epsilon_1}^{x+\epsilon_2} f(\xi) \frac{1-a^2}{1-2a \cos(\xi-x) + a^2} d\xi,$$

and putting $\xi = x + \phi$ and remembering that $f'(\xi)$, being finite by supposition, the change in $f(\xi)$ is insensibly small between these close limits, we have

$$\begin{aligned} I &= f(x) L_{a \rightarrow 1} \int_{-\epsilon_1}^{\epsilon_2} \frac{1-a^2}{1-2a \cos \phi + a^2} d\phi \\ &= 2f(x) L_{a \rightarrow 1} \left[\tan^{-1} \frac{1+a}{1-a} \tan \frac{\phi}{2} \right]_{-\epsilon_1}^{\epsilon_2} \end{aligned}$$

$$\begin{aligned}
&= 2f(x) Lt_{a \rightarrow 1} \left[\tan^{-1} \frac{\phi}{1-a} \right]_{-\epsilon_1}^{\epsilon_2}, \text{ since } \phi \text{ is very small,} \\
&= 2f(x) Lt_{a \rightarrow 1} \left\{ \tan^{-1} \frac{\epsilon_2}{1-a} + \tan^{-1} \frac{\epsilon_1}{1-a} \right\}.
\end{aligned}$$

In proceeding to the limit, however small ϵ_1 and ϵ_2 may have been taken, $1-a$ becomes, in its unlimited decrease to zero, a positive infinitesimal of higher order than either ϵ_1 or ϵ_2 .

Hence I converges to the limiting value

$$2f(x) \left(\frac{\pi}{2} + \frac{\pi}{2} \right), \text{ or } 2\pi f(x).$$

Secondly, supposing x to lie beyond the limit a but $< \beta + 2\pi$, i.e. $\beta < a < x < \beta + 2\pi$, then evidently $I=0$, for the denominator of the integrand never vanishes as ξ ranges from β to a .

Thirdly, supposing x to lie at the upper limit, i.e. $x=a$, then $\int_{\beta}^a () d\xi = \left(\int_{\beta}^{a-\epsilon} + \int_{a-\epsilon}^a \right) () d\xi$, in which the first integral vanishes as before and the second becomes

$$= 2f(x) Lt_{a \rightarrow 1} \tan^{-1} \frac{\epsilon}{1-a} = 2f(x) \cdot \frac{\pi}{2} = \pi f(a); \quad \therefore I = \pi f(a).$$

In the same way if x lie at the lower limit, i.e. $x=\beta$, we have similarly $I = \pi f(\beta)$.

Fourthly, supposing $a-\beta=2\pi$ and $\beta < x < a$, we have, as before, $I = 2\pi f(x)$. But if $x=\beta$ or $x=a$, the integrand becomes infinite at both ends of the range, and in either case we have

$$I = 2f(a) \frac{\pi}{2} + 2f(\beta) \frac{\pi}{2} = \pi \{ f(a) + f(\beta) \}.$$

Finally, supposing that at any point $x=c$ between a and β , $f(\xi)$ becomes discontinuous, suddenly changing its value from $f_1(c)$ to $f_2(c)$ as ξ passes through the value c ; then

$$\begin{aligned}
I &= Lt_{a \rightarrow 1} \left(\int_{\beta}^{c-\epsilon_1} + \int_{c-\epsilon_1}^{c+\epsilon_2} + \int_{c+\epsilon_2}^a \right) () d\xi \\
&= Lt_{a \rightarrow 1} \int_{c-\epsilon_1}^{c+\epsilon_2} () d\xi, \text{ as in the first case,} \\
&= Lt_{a \rightarrow 1} 2 \left\{ f_2(c) \tan^{-1} \frac{\epsilon_2}{1-a} + f_1(c) \tan^{-1} \frac{\epsilon_1}{1-a} \right\} \\
&= 2 \left\{ f_1(c) \cdot \frac{\pi}{2} + f_2(c) \cdot \frac{\pi}{2} \right\} = \pi \{ f_1(c) + f_2(c) \}.
\end{aligned}$$

This completes the investigation of one cycle of the changes in the value of I as x increases from $x=\beta$ to $x=\beta+2\pi$.

1598. Extension of Range of Integration.

For a greater range of values of x the values found in the above cycle are merely repeated. For instance, in the next cycle, viz. $x=\beta+2\pi$ to $x=\beta+4\pi$, putting $x=2\pi+x'$, we have merely to replace $f(x)$ in the above results by $f(x')$, i.e. $f(x-2\pi)$, and to make no other change. If x lies between $x=\beta+2n\pi$ and $x=\beta+2(n+1)\pi$, we replace $f(x)$ by $f(x-2n\pi)$.

We exhibit in Figs. 458 to 461 graphs of

$$y = \frac{1}{2\pi} L_{a \rightarrow 1} \int_{\beta}^x f(\xi) \frac{1-a^2}{1-2a \cos(\xi-x) + a^2} d\xi$$

for the four cases $a-\beta < 2\pi$, $a-\beta=2\pi$, with no discontinuity and with a discontinuity.

It will be noted that in the case of discontinuity in the ordinate of the graph of the limiting value of this integral, the value at the change is represented by half the sum of the two immediately contiguous adjacent ordinates on either side

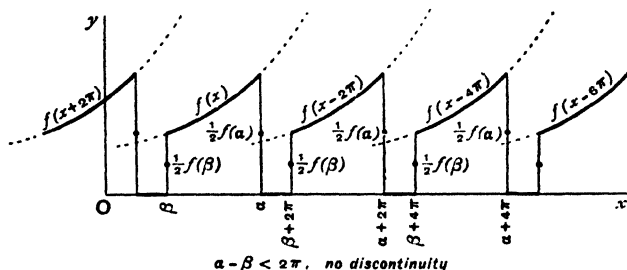

Fig. 458.

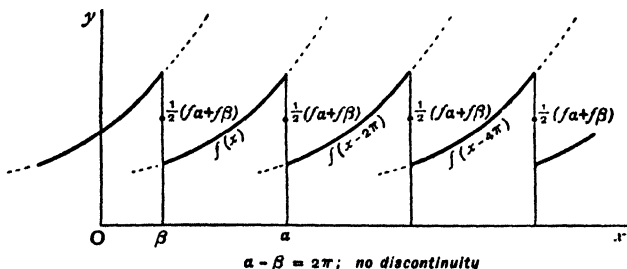

Fig. 459.

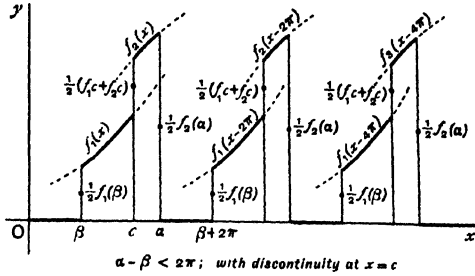

Fig. 460.

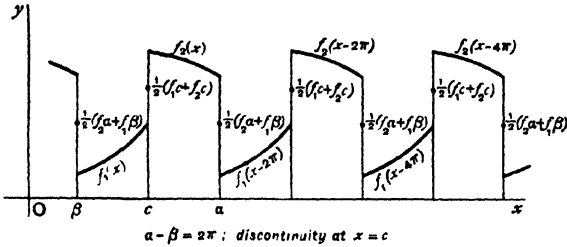

Fig. 461.

of the discontinuity. The graphs consist then of an infinite series of equal arcs or lines, together with an infinite series of isolated points.

1599. **Geometrical Examination of the above Results.**

Consider the nature of the curve $\eta = \frac{1-a^2}{1-2a \cos(\xi-x) + a^2}$ referred to axes $O\xi, O\eta$, or, what is the same thing,

$$\eta = \frac{1-a}{1+a} \frac{\sec^2 \frac{\xi-x}{2}}{\left(\frac{1-a}{1+a}\right)^2 + \tan^2 \frac{\xi-x}{2}}$$

where x is kept constant and a positive and not greater than unity.

The curve is obviously of periodic character, for η is unaltered if we write $\xi \pm 2n\pi$ in place of ξ , n being an integer.

The maximum and minimum ordinates occur when

$$\sin(\xi-x) = 0,$$

i.e. at the points $\xi = x, \pi + x, 2\pi + x, 3\pi + x$, etc.; the first,

third, fifth, etc., giving the maxima, and the second, fourth, sixth, etc., the minima.

These maxima and minima values are alternately $\frac{1+a}{1-a}$ and $\frac{1-a}{1+a}$, and the range from one stationary point to the next is π . Fig. 462 represents a cycle of the values of the ordinate. The remainder of the curve consists of repetitions of the portion between any two successive maxima.

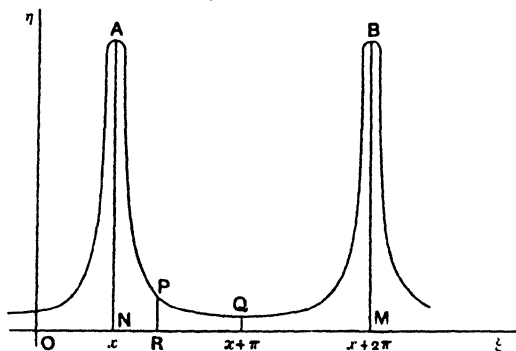

Fig. 462.

As a increases to the vicinity of 1 the maxima increase very rapidly and tend to infinity, and the minima become indefinitely small.

The area bounded by any complete half-cycle, the x -axis and the terminal ordinates, extending from a maximum ordinate to the next minimum, is

$$\int_x^{x+\pi} \eta d\xi = 2 \left[\tan^{-1} \left(\frac{1+a}{1-a} \right) \tan \frac{\xi-x}{2} \right]_x^{x+\pi} = 2 \tan^{-1} \left(\frac{1+a}{1-a} \tan \frac{\pi}{2} \right) = \pi$$

for any of the values of the parameter a .

Thus, in Fig. 462, the area $ANMBQA = 2\pi$.

Let PR be an ordinate with abscissa $x + \epsilon$. The area of the portion $ANRP$ is $\int_x^{x+\epsilon} \eta d\xi = 2 \tan^{-1} \left(\frac{1+a}{1-a} \tan \frac{\epsilon}{2} \right)$, and evidently, however small ϵ may have been taken, when $1-a$, which is decreasing indefinitely, has become an infinitesimal of higher order than ϵ , this converges to the value π . Hence it appears that the descent of the curve on each side of a maximum ordinate is very rapid when a is nearly unity, and that between

two successive maxima the curve in that case flattens out into ultimate coincidence with the intercepted portion of the ξ -axis, so that a point travelling along the curve travels along the ξ -axis up to immediate contiguity with a maximum ordinate, then travels to infinity along that ordinate, descends on the opposite side and then resumes its march along the ξ -axis.

Hence in integrating from any value $\xi=\beta$ to another limit $\xi=a$, in which the range from β to a is $< 2\pi$, the result will be zero unless a maximum ordinate lies between the limits, and the result will be 2π if a maximum ordinate does lie between the limits.

Also if $a-\beta=2\pi$, one maximum must lie between the limits, and the result will then be 2π , as is also the case when one maximum lies at $\xi=\beta$ and the next at $\xi=a$, the integral in that case becoming sensible at each limit.

It becomes clear, then, that if two ordinates be drawn on opposite sides of a maximum ordinate and contiguous to it, the area bounded by these ordinates, the curve and the intercepted portion of the x -axis tends to the limit 2π when a is made sufficiently near unity, however closely the ordinates are made to approach the maximum ordinate.

1600. Further, the presence of any finite factor $f(\xi)$ in the integrand for which the integral takes the form $\int_{\eta} f(\xi) d\xi$ will only affect the value of the integral when the value of η is sensible, even if at any point $\xi=x$ between the limits $f(\xi)$ be discontinuous and suddenly changes its value from $f_1(x)$ to $f_2(x)$ at such point, provided that both $f_1(x)$ and $f_2(x)$ be finite. So that $\int_{\beta}^{\alpha} f(\xi) d\xi$ is zero when the range from β to α does not include one of the maximum η -values. In case a maximum of η does occur between the limits, say, between $\xi=x-\epsilon_1$ and $\xi=x+\epsilon_2$, where ϵ_1 and ϵ_2 are very small, let A and B be respectively the greatest and least of the values of $f(\xi)$ in this range. Then

$$\int_{\beta}^{\alpha} \eta A d\xi > \int_{\beta}^{\alpha} \eta f(\xi) d\xi > \int_{\beta}^{\alpha} \eta B d\xi,$$

i.e. $\int_{\beta}^{\alpha} \eta f(\xi) d\xi$ lies between $2\pi A$ and $2\pi B$.

Now, if $f(\xi)$ be single valued, finite and continuous, as ξ passes from $\xi = x - \epsilon_1$ to $\xi = x + \epsilon_2$, where ϵ_1 and ϵ_2 are made infinitesimally small, the change in $f(\xi)$ in passing from ξ to $\xi + h$ intermediate between these limits has been shown to be infinitesimal, provided $f'(\xi)$ be finite. That is, A and B are ultimately equal when ϵ_1 and ϵ_2 are taken sufficiently small.

$$\text{Therefore } \int_{\beta}^{\alpha} \eta f(\xi) d\xi = 2\pi f(x)$$

But if whilst the range β to α includes one of the maximum η -values there be at the same point a discontinuity, $f(\xi)$ changing from $f_1(x)$ to $f_2(x)$ as ξ passes through $\xi = x$, we have

$$\begin{aligned} \int_{\beta}^{\alpha} \eta f(\xi) d\xi &= \int_{\beta}^{x-\epsilon_1} \eta f(\xi) d\xi + \int_{x-\epsilon_1}^x \eta f(\xi) d\xi + \int_x^{x+\epsilon_2} \eta f(\xi) d\xi + \int_{x+\epsilon_2}^{\alpha} \eta f(\xi) d\xi \\ &= 0 + \pi f_1(x) + \pi f_2(x) + 0 = \pi \{f_1(x) + f_2(x)\}. \end{aligned}$$

[See Donkin, *Acoustics*, pages 60-66.]

1601. Consideration of Fourier's Series from the Point of View of a Summation. Poisson's Method of Investigation, mainly of Historical Interest.

We may now turn to the consideration of the formulae of Art. 1591, from the point of view of a summation of the series, supposed to be uniformly convergent,

$$\int_{\beta}^{\alpha} f(\xi) d\xi + 2 \sum_{p=1}^{p=\infty} \int_{\beta}^{\alpha} f(\xi) \cos p(\xi - x) d\xi, \dots\dots\dots(1)$$

and endeavour to discover what such series represents in the various cases: (i) $\beta < x < \alpha$; (ii) $x = \beta$ or $x = \alpha$; (iii) x outside these limits; (iv) when $f(\xi)$ presents discontinuities.

Starting with the identity

$$1 + 2a \cos \theta + 2a^2 \cos 2\theta + 2a^3 \cos 3\theta + \dots = \frac{1 - a^2}{1 - 2a \cos \theta + a^2},$$

in which the left-hand member preserves its uniform convergency for any range of values of θ so long as $|a| < 1$, put $\theta = \xi - x$, multiply by $f(\xi)$ and integrate from $\xi = \beta$ to $\xi = \alpha$, where $\alpha - \beta > 2\pi$.

We then get

$$\begin{aligned} \int_{\beta}^{\alpha} f(\xi) d\xi + 2 \sum_{p=1}^{p=\infty} a^p \int_{\beta}^{\alpha} f(\xi) \cos p(\xi - x) d\xi \\ = \int_{\beta}^{\alpha} f(\xi) \frac{1 - a^2}{1 - 2a \cos(\xi - x) + a^2} d\xi. \dots\dots(2) \end{aligned}$$

If we then make a approach indefinitely near to unity, the left side tends indefinitely closely to the value of the series (1).

The right-hand member of the equality (2) under the same circumstances tends to a limit which has been discussed in the previous articles.

If we assume the uniform convergency of series (1) and that *what is true within any infinitesimal distance of the limit, of however high an order of smallness that distance may be, is true in the limit*, we have

$$\begin{aligned} & \frac{1}{2\pi} \int_{\beta}^a f(\xi) d\xi + \frac{1}{\pi} \sum_{p=1}^{p=\infty} \int_{\beta}^a f(\xi) \cos p(\xi-x) d\xi \\ & \quad = f(x) \quad \text{if } a > x > \beta \\ & \quad \text{or } = \frac{1}{2} f(a) \quad \text{if } x=a \quad \text{or } \frac{1}{2} f(\beta) \quad \text{if } x=\beta \quad \left. \vphantom{\int} \right\} a-\beta < 2\pi, \\ & \quad \text{or } = 0 \quad \text{if } 2\pi+\beta > x > a \\ & \quad \text{or } = f(x) \quad \text{if } a > x > \beta \quad \left. \vphantom{\int} \right\} a-\beta = 2\pi. \\ & \quad \text{or } = \frac{1}{2} \{f(a)+f(\beta)\} \quad \text{if } x=a \quad \text{or } x=\beta \end{aligned}$$

The assumption made in Poisson's investigation in the words italicised will be avoided in the method of investigation adopted by Dirichlet and discussed later.

In either case, if there be a discontinuity at $x=c$, where the value of $f(x)$ changes abruptly from $f_1(c)$ to $f_2(c)$, both being finite, the value is $\frac{1}{2} \{f_1(c)+f_2(c)\}$ for such value of x .

If x lie outside the limits β and a , say between $\beta+2n\pi$ and $\beta+2(n+1)\pi$, $f(x)$ in the above results is to be replaced by $f(x-2n\pi)$.

1602. Important Cases.

The most important cases are (i) $\beta=0, a=2\pi$; (ii) $\beta=-\pi, a=\pi$; (iii) $\beta=0, a=\pi$, and in these we have respectively

$$\begin{aligned} \text{(i)} \quad & \frac{1}{2\pi} \int_0^{2\pi} f(\xi) d\xi + \frac{1}{\pi} \sum_1^{\infty} \int_0^{2\pi} f(\xi) \cos p(\xi-x) d\xi \\ & \quad = f(x) \quad \text{if } 2\pi > x > 0; \\ & \quad \text{or } = \frac{1}{2} \{f(0)+f(2\pi)\} \quad \text{if } x=0 \quad \text{or } 2\pi \quad \text{or } 2n\pi; \\ & \quad \text{or } = f(x-2n\pi) \quad \text{if } 2(n+1)\pi > x > 2n\pi. \\ \text{(ii)} \quad & \frac{1}{2\pi} \int_{-\pi}^{\pi} f(\xi) d\xi + \frac{1}{\pi} \sum_1^{\infty} \int_{-\pi}^{\pi} f(\xi) \cos p(\xi-x) d\xi \\ & \quad = f(x) \quad \text{if } \pi > x > -\pi; \\ & \quad \text{or } = \frac{1}{2} \{f(-\pi)+f(\pi)\} \quad \text{if } x=-\pi \quad \text{or } \pi \quad \text{or } (2n+1)\pi; \\ & \quad \text{or } = f(x-2n\pi) \quad \text{if } (2n+1)\pi > x > (2n-1)\pi. \end{aligned}$$

$$\begin{aligned}
 \text{(iii)} \quad & \frac{1}{2\pi} \int_0^\pi f(\xi) d\xi + \frac{1}{\pi} \sum_1^\infty \int_0^\pi f(\xi) \cos p(\xi-x) d\xi \\
 & = f(x) && \text{if } \pi > x > 0; \\
 \text{or} \quad & = 0 && \text{if } 2\pi > x > \pi; \\
 \text{or} \quad & = \frac{1}{2} f(0) && \text{if } x=0 \text{ or } 2n\pi; \\
 \text{or} \quad & = \frac{1}{2} f(\pi) && \text{if } x=\pi \text{ or } (2n+1)\pi; \\
 \text{or} \quad & = f(x-2n\pi) && \text{if } (2n+1)\pi > x > 2n\pi; \\
 \text{or} \quad & = 0 && \text{if } 2n\pi > x > (2n-1)\pi.
 \end{aligned}$$

1603. The same results may be exhibited in another form with limits in terms of l instead of π by changing the variables so that $\xi = \frac{\pi}{l}\eta$, $x = \frac{\pi}{l}y$. Then

$$d\xi = \frac{\pi}{l} d\eta \quad \text{and} \quad f(\xi) = f\left(\frac{\pi}{l}\eta\right) = F(\eta), \text{ say.}$$

Then the result

$$\begin{aligned}
 & \frac{1}{2\pi} \int_\beta^\pi f(\xi) d\xi + \frac{1}{\pi} \sum_1^\infty \int_\beta^\pi f(\xi) \cos p(\xi-x) d\xi = f(x) \\
 \text{becomes} \quad & \frac{1}{2l} \int_{\beta l}^{\pi l} F(\eta) d\eta + \frac{1}{l} \sum_1^\infty \int_{\beta l}^{\pi l} F(\eta) \cos \frac{p\pi}{l}(\eta-y) d\eta = F(y)
 \end{aligned}$$

And the particular results (i), (ii), (iii) become, if we finally replace η by ξ , y by x and F by f to preserve conformity in the notation,

$$\begin{aligned}
 \text{(i)} \quad & \frac{1}{2l} \int_0^{2l} f(\xi) d\xi + \frac{1}{l} \sum_1^\infty \int_0^{2l} f(\xi) \cos \frac{p\pi}{l}(\xi-x) d\xi \\
 & = f(x) && \text{if } 2l > x > 0; \\
 \text{or} \quad & = \frac{1}{2} \{f(0) + f(2l)\} && \text{if } x=0, 2l \text{ or } 2nl; \\
 \text{or} \quad & = f(x-2nl) && \text{if } 2(n+1)l > x > 2nl. \\
 \text{(ii)} \quad & \frac{1}{2l} \int_{-l}^l f(\xi) d\xi + \frac{1}{l} \sum_1^\infty \int_{-l}^l f(\xi) \cos \frac{p\pi}{l}(\xi-x) d\xi \\
 & = f(x) && \text{if } l > x > -l; \\
 \text{or} \quad & = \frac{1}{2} \{f(-l) + f(l)\} && \text{if } x=-l \text{ or } l \text{ or } (2n+1)l; \\
 \text{or} \quad & = f(x-2nl) && \text{if } (2n+1)l > x > (2n-1)l. \\
 \text{(iii)} \quad & \frac{1}{2l} \int_0^l f(\xi) d\xi + \frac{1}{l} \sum_1^\infty \int_0^l f(\xi) \cos \frac{p\pi}{l}(\xi-x) d\xi \\
 & = f(x) && \text{if } l > x > 0;
 \end{aligned}$$

$$\begin{array}{ll}
\text{or} = 0 & \text{if } 2l > x > l; \\
\text{or} = \frac{1}{2}f(0) & \text{if } x=0 \text{ or } 2nl; \\
\text{or} = \frac{1}{2}f(l) & \text{if } x=l \text{ or } (2n+1)l; \\
\text{or} = f(x-2nl) & \text{if } (2n+1)l > x > 2nl; \\
\text{or} = 0 & \text{if } 2nl > x > (2n-1)l.
\end{array}$$

If, in Art. 1601, we had written $\xi+x$ for θ instead of $\xi-x$, equation (iii) above would have been replaced by

$$\begin{array}{ll}
\frac{1}{2l} \int_0^l f(\xi) d\xi + \frac{1}{l} \sum_1^{\infty} \int_0^l f(\xi) \cos \frac{p\pi}{l} (\xi+x) d\xi \\
= 0 & \text{if } l > x > 0; \\
\text{or} = \frac{1}{2}f(0) & \text{if } x=0; \\
\text{or} = \frac{1}{2}f(l) & \text{if } x=l.
\end{array}$$

Hence adding,

$$\begin{array}{ll}
\frac{1}{2l} \int_0^l f(\xi) d\xi + \frac{1}{l} \sum_1^{\infty} \int_0^l f(\xi) \cos \frac{p\pi\xi}{l} \cos \frac{p\pi x}{l} d\xi \\
= \frac{1}{2}f(x) & \text{if } l > x > 0; \\
\text{or} = \frac{1}{2}f(0) & \text{if } x=0; \\
\text{or} = \frac{1}{2}f(l) & \text{if } x=l;
\end{array}$$

i.e. the formula holds *inclusive* of the values at the limits, viz.

$$\frac{1}{l} \int_0^l f(\xi) d\xi + \frac{2}{l} \sum_1^{\infty} \cos \frac{p\pi x}{l} \int_0^l f(\xi) \cos \frac{p\pi\xi}{l} d\xi = f(x)$$

from $x=0$ to $x=l$ *inclusive*.

If we change the sign of x the left side is unaltered. The right side must then be written $f(-x)$. From $x=l$ to $x=2l$, putting $x=2l-x'$, $\cos \frac{p\pi x}{l} = \cos \frac{p\pi}{l} (2l-x') = \cos \frac{p\pi x'}{l}$, and the result is $f(x')$ or $f(2l-x)$; and so on. So that the results are

$$\left. \begin{array}{l}
-l \text{ to } 0 \\
0 \text{ to } l \\
l \text{ to } 2l \\
2l \text{ to } 3l \\
3l \text{ to } 4l \\
4l \text{ to } 5l
\end{array} \right\} \begin{array}{l}
f(-x) \\
f(x) \\
f(2l-x) \\
f(x-2l) \\
f(4l-x) \\
f(x-4l)
\end{array}$$

and so on, as illustrated in Fig. 463.

1604. If we subtract the same integrals, we get

$$\begin{array}{ll}
\frac{2}{l} \sum_1^{\infty} \sin \frac{p\pi x}{l} \int_0^l f(\xi) \sin \frac{p\pi\xi}{l} d\xi = f(x) & \text{if } l > x > 0; \\
\text{or} = 0 & \text{if } x=0 \text{ or } l.
\end{array}$$

Hence in this case the values for $x=0$ and $x=l$ are *excluded*.

Moreover, a change in the sign of x changes the sign of the left side. Hence if x lie between $-l$ and 0 , we have

$$\frac{2}{l} \sum_1^{\infty} \sin \frac{p\pi x}{l} \int_0^l f(\xi) \sin \frac{p\pi \xi}{l} d\xi = -f(-x).$$

The graph of the several changes is exhibited in Fig. 464.

1605. Graphical Representation of the Previous Results.

Let $S \equiv \frac{1}{l} \int_0^l f(\xi) d\xi + \frac{2}{l} \sum_1^{\infty} \cos \frac{p\pi x}{l} \int_0^l f(\xi) \cos \frac{p\pi \xi}{l} d\xi$ for any value of x .

Then if $l \geq x \geq 0$, $S = f(x)$.

(a) Consider $2l \geq x \geq l$.

Put $x = 2l - x'$; then $l \geq x' \geq 0$, $\cos \frac{p\pi x}{l} = \cos \frac{p\pi x'}{l}$.

Then $S = f(x') = f(2l - x)$.

(β) Consider $3l \geq x \geq 2l$.

Put $x = 2l + x''$; then $l \geq x'' \geq 0$, $\cos \frac{p\pi x}{l} = \cos \frac{p\pi x''}{l}$.

Then $S = f(x'') = f(x - 2l)$.

(γ) Consider $4l \geq x \geq 3l$.

Put $x = 4l - x'''$; then $l \geq x''' \geq 0$, $\cos \frac{p\pi x}{l} = \cos \frac{p\pi x'''}{l}$.

Then $S = f(x''') = f(4l - x)$. And so on.

Also since a change of sign in x does not affect the value of S , the y -axis is an axis of symmetry of its graph.

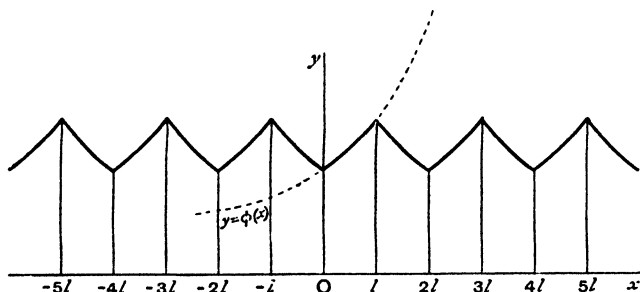

Fig. 463.

The graph of $y = S$ therefore consists of a succession of repetitions of the alternate arcs of $y = f(-x)$ from $-l$ to 0 , and of $y = f(x)$ from 0 to l , coinciding with the graph of $y = f(x)$ only from 0 to l and with its image with respect to the y -axis from $-l$ to 0 .

1606. Let $S' \equiv \frac{2}{l} \sum_1^{\infty} \sin \frac{p\pi x}{l} \int_0^l \sin \frac{p\pi \xi}{l} d\xi$ for all values of x .

Then if $x = 0$, $S' = 0$; if $l > x > 0$, $S' = f(x)$; if $x = l$, $S' = 0$.

(a) Consider $2l > x > l$.

Put $x = 2l - x'$; then $l > x' > 0$, $\sin \frac{p\pi x}{l} = -\sin \frac{p\pi x'}{l}$.

Then $S' = -f(x') = -f(2l - x)$; and if $x = 2l$ or l , $S' = 0$.

(β) Consider $3l > x > 2l$.

Put $x = 2l + x''$; then $l > x'' > 0$, $\sin \frac{p\pi x}{l} = \sin \frac{p\pi x''}{l}$.

Then $S' = f(x'') = f(x - 2l)$; and if $x = 3l$ or $2l$, $S' = 0$.

(γ) Consider $4l > x > 3l$.

Put $x = 4l - x'''$; then $l > x''' > 0$, $\sin \frac{p\pi x}{l} = -\sin \frac{p\pi x'''}{l}$.

Then $S' = -f(x''') = -f(4l - x)$; and if $x = 4l$ or $3l$, $S' = 0$. And so on

Also S' changes sign with x . Therefore the y -axis is no longer an axis of symmetry, but the origin is a centre of symmetry for the graph of S' .

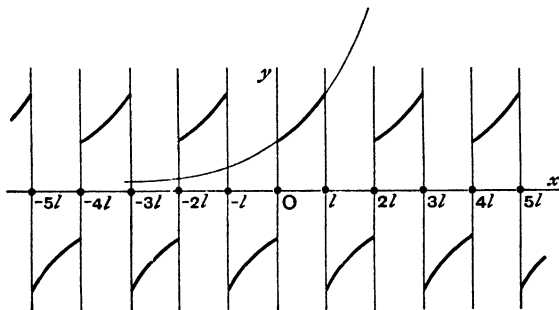

Fig. 464.

The graph of $y = S'$ therefore consists of a succession of repetitions of the alternate arcs of $y = -f(-x)$ from $-l$ to 0 and of $y = f(x)$ from 0 to l , coinciding with the graph of $y = f(x)$ only from 0 to l , together with a series of isolated points on the x -axis equably distributed at distances $= l$, starting with the origin.

The effect of a *discontinuity* in $f(x)$ existing between 0 and l would be similar to that shown in Fig. 461 at C in the segment from β to a , with a corresponding change in each of the other segments in Fig. 464.

1607. Let $S'' \equiv \frac{1}{2l} \int_{-l}^l f(\xi) d\xi + \frac{1}{l} \int_{-l}^l f(\xi) \cos \frac{p\pi}{l} (\xi - x) d\xi$ for all values of x .

Then if $x = -l$, $S'' = \frac{1}{2} \{f(l) + f(-l)\}$; if $-l < x < l$, $S'' = f(x)$; if $x = l$, $S'' = \frac{1}{2} \{f(l) + f(-l)\}$.

(a) Consider $3l > x > l$.

Put $x = 2l + x'$; then $-l < x' < l$, $\cos \frac{p\pi}{l} (\xi - x) = \cos \frac{p\pi}{l} (\xi - x')$.

Then $S'' = f(x') = f(x - 2l)$; and if $x = l$ or $3l$, $S'' = \frac{1}{2} \{f(l) + f(-l)\}$.

(β) Consider $5l > x > 3l$.

Put $x = 4l + x''$; then $-l < x'' < l$, $\cos \frac{p\pi}{l} (\xi - x) = \cos \frac{p\pi}{l} (\xi - x'')$.

Then $S'' = f(x'') = f(x - 4l)$; and if $x = 3l$ or $5l$, $S'' = \frac{1}{2}\{f(l) + f(-l)\}$.
And so on.

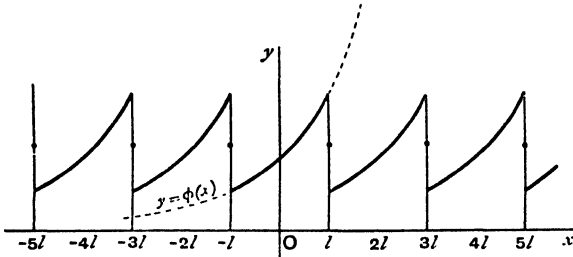

Fig. 465.

Hence the graph of $y = S''$ consists of a series of repetitions of the portion of the graph of $y = f(x)$ which lies between $x = -l$ and $x = l$, together with a series of isolated points whose abscissae are $-3l, -l, l, 3l$, etc., and ordinates $\frac{1}{2}\{f(l) + f(-l)\}$; the graph of $y = S''$ coinciding with that of $y = f(x)$ itself only between $-l$ and l .

1608. Case of a Discontinuity.

If a discontinuity in $f(x)$ occurs between $x = -l$ and $x = l$, say at $x = c$, where $l > c > -l$, the function changing abruptly from $f_1(x)$ to $f_2(x)$, say, both finite, the graph becomes that of Fig. 466, where the thick line shows

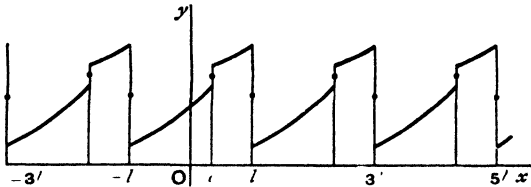

Fig. 466.

the variation of the expression S'' for different values of x and the dots, the values at $-l, c, l, 2l + c, 3l$, etc. The graph of $y = S''$ only coincides with that of $y = f_1(x)$ from $-l$ to c , and with that of $y = f_2(x)$ from c to l .

1609. Another Form of the Result.

Writing $-\xi$ for ξ in the formula

$$\frac{1}{2l} \int_{-l}^l f(\xi) d\xi + \frac{1}{l} \sum_{n=1}^{\infty} \int_{-l}^l f(\xi) \cos \frac{p\pi}{l} (\xi - x) d\xi = f(x) \text{ between } -l \text{ and } l,$$

$$\text{or } = \frac{1}{2}\{f(l) + f(-l)\} \text{ at } x = \pm l,$$

we have

$$\frac{1}{2l} \int_{-l}^l f(-\xi) d\xi + \frac{1}{l} \sum_{n=1}^{\infty} \int_{-l}^l f(-\xi) \cos \frac{p\pi}{l} (\xi + x) d\xi = f(x) \text{ between } -l \text{ and } l,$$

$$\text{or } = \frac{1}{2}\{f(l) + f(-l)\} \text{ at } x = \pm l.$$

Hence

$$\begin{aligned} \frac{1}{2l} \int_{-l}^l \frac{f(\xi) + f(-\xi)}{2} d\xi + \frac{1}{l} \sum_1^{\infty} \cos \frac{p\pi x}{l} \int_{-l}^l \frac{f(\xi) + f(-\xi)}{2} \cos \frac{p\pi \xi}{l} d\xi \\ + \frac{1}{l} \sum_1^{\infty} \sin \frac{p\pi x}{l} \int_{-l}^l \frac{f(\xi) - f(-\xi)}{2} \sin \frac{p\pi \xi}{l} d\xi \\ = f(x) \text{ if } l > x > -l \text{ and } = \frac{1}{2} \{f(l) + f(-l)\} \text{ if } x = \pm l \end{aligned}$$

And the three integrals occurring between limits $-l$ and l are each double of the integrals from 0 to l .

$$\begin{aligned} \therefore \frac{1}{l} \int_0^l \frac{f(\xi) + f(-\xi)}{2} d\xi + \frac{2}{l} \sum_1^{\infty} \cos \frac{p\pi x}{l} \int_0^l \frac{f(\xi) + f(-\xi)}{2} \cos \frac{p\pi \xi}{l} d\xi \\ + \frac{2}{l} \sum_1^{\infty} \sin \frac{p\pi x}{l} \int_0^l \frac{f(\xi) - f(-\xi)}{2} \sin \frac{p\pi \xi}{l} d\xi \\ = f(x) \text{ if } l > x > -l \text{ and } = \frac{1}{2} \{f(l) + f(-l)\} \text{ if } x = \pm l. \end{aligned}$$

1610. It has been seen that a Fourier-Series

$$A_0 + \sum_1^{\infty} A_p \sin (px + a_p)$$

is under certain very general conditions a proper analytical expression for an arbitrary function $f(x)$ between specific values of the variable x . The function has been assumed single valued, real, continuous and either lying between certain finite limits, and integrable for the range, or if not so bounded its integral for that range is assumed absolutely convergent. The possibility of expansion has been assumed in the method of undetermined coefficients, and the possibility of integration of the series term by term when multiplied by $f(x)$ throughout has also been assumed. With these assumptions it appears that when such a solution can be found and the convergence of the resulting series is uniform, the solution is unique.

1611. Applications.

(1) Apply Art. 1595 to expand x in a series of sines of multiples of x ($\pi > x > 0$).

The formula is $f(x) = \frac{2}{l} \sum_1^{\infty} \sin \frac{p\pi x}{l} \int_0^l f(\xi) \sin \frac{p\pi \xi}{l} d\xi$ ($l > x > 0$). But if $x=0$ or l , $f(x)$ on the left side must be replaced by 0.

Take $l=\pi$. Then

$$\int_0^{\pi} \xi \sin p\xi d\xi = \left[\xi \left(-\frac{\cos p\xi}{p} \right) - \left(-\frac{\sin p\xi}{p^2} \right) \right]_0^{\pi} = \frac{\pi}{p} (-1)^{p+1}.$$

Then

$$\frac{x}{2} = \sum_1^{\infty} (-1)^{p+1} \frac{\sin px}{p} = \frac{1}{1} \sin x - \frac{1}{2} \sin 2x + \frac{1}{3} \sin 3x - \frac{1}{4} \sin 4x + \dots \dots (A)$$

for values of x between 0 and π . And the left side must be replaced by 0 if $x=0$ or π . The expansion holds therefore from $x=0$ (inclusive) to $x=\pi$ (exclusive).

A change in sign of x affects both sides. Hence if the theorem holds for any particular positive value of x , it holds also for the corresponding negative value of x . It therefore holds for all values of x from $-\pi$ to $+\pi$ both exclusive.

If $\pi < x < 2\pi$, let $x = 2\pi - x'$, i.e. $\pi > x' > 0$.

$$\text{Then the series} = -\left(\frac{1}{1} \sin x' - \frac{1}{2} \sin 2x' + \frac{1}{3} \sin 3x' - \dots\right) = -\frac{x'}{2} = \frac{x-2\pi}{2}.$$

If $2\pi < x < 3\pi$, let $x = 2\pi + x''$, i.e. $\pi > x'' > 0$.

$$\text{Then the series} = \frac{1}{1} \sin x'' - \frac{1}{2} \sin 2x'' + \frac{1}{3} \sin 3x'' - \dots = \frac{x''}{2} = \frac{x-2\pi}{2}.$$

If $3\pi < x < 4\pi$, let $x = 4\pi - x'''$. Then the series = $-\frac{1}{2} x''' = \frac{x-4\pi}{2}$, and so on, and the graph of $y = \frac{1}{1} \sin x - \frac{1}{2} \sin 2x + \frac{1}{3} \sin 3x - \dots$ will consist of lines through 0, 2π , 4π , etc., parallel to $2y = x$, with points on the x -axis at π , 3π , 5π , etc.

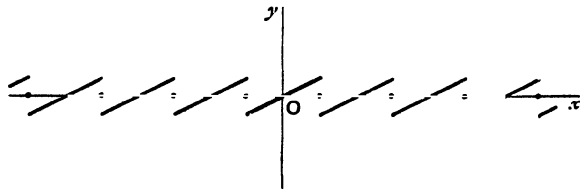

Fig. 467.

1612. (2) Expand e^{ax} in a series of sines of multiples of x , $0 < x < \pi$, and examine the series obtained.

$$\text{Taking } e^{ax} = \sum_1^{\infty} B_p \sin px, \text{ we have } \int_0^{\pi} e^{ax} \sin px \, dx = B_p \cdot \frac{\pi}{2};$$

$$\therefore B_p = \frac{2}{\pi} \left[e^{ax} \frac{\sin px - p \cos px}{a^2 + p^2} \right]_0^{\pi} = \frac{2}{\pi} \frac{p}{a^2 + p^2} \{1 - (-1)^p e^{a\pi}\};$$

$$\therefore e^{ax} = \frac{2}{\pi} \left\{ \frac{1 + e^{a\pi}}{a^2 + 1^2} \sin x + 2 \frac{1 - e^{a\pi}}{a^2 + 2^2} \sin 2x + 3 \frac{1 + e^{a\pi}}{a^2 + 3^2} \sin 3x + \dots \right\} \quad (\pi > x > 0).$$

But the series = 0 at $x=0$ or $x=\pi$.

If $2\pi > x > \pi$, let $x = 2\pi - x'$, i.e. $\pi > x' > 0$. Then the series becomes

$$-\frac{2}{\pi} \left\{ \frac{1 + e^{2\pi}}{a^2 + 1^2} \sin x' + 2 \frac{1 - e^{2\pi}}{a^2 + 2^2} \sin 2x' + \dots \right\} = -e^{ax'} = -e^{a(2\pi-x)}.$$

If $3\pi > x > 2\pi$, let $x = 2\pi + x''$, i.e. $\pi > x'' > 0$. Then the series becomes $e^{ax''} = e^{a(x-2\pi)}$, and so on. Also at $x=0$, π , 2π , etc., the series is zero.

Hence we have for the graph of

$$y = \frac{2}{\pi} \left\{ \frac{1 + e^{a\pi}}{a^2 + 1^2} \sin x + 2 \frac{1 - e^{a\pi}}{a^2 + 2^2} \sin 2x + 3 \frac{1 + e^{a\pi}}{a^2 + 3^2} + \text{etc.} \right\}$$

a figure consisting of a series of arcs equal to that of the curve $y = e^{ax}$, between 0 and π , alternately above and below the x -axis, the origin being a centre of symmetry, together with the points $x = 0, \pm\pi, +2\pi, \text{etc.}$, on the x -axis, any of which is a centre of symmetry for the whole graph (Fig. 468).

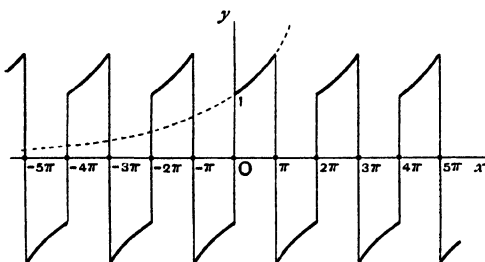

Fig. 468.

1613. (3) To find a function of x , viz. $f(x)$, which shall be periodic with period $2l$, and shall be

$$= \frac{l}{4} \text{ from } -l \text{ to } -\frac{l}{2}; = \frac{x^2}{l} \text{ from } -\frac{l}{2} \text{ to } +\frac{l}{2}; = \frac{l}{4} \text{ from } \frac{l}{2} \text{ to } l.$$

Let $f(x) = A_0 + \sum_1^{\infty} A_p \cos \frac{p\pi x}{l}$, the cosine series being selected because negative values and positive values of x are to give the same result.

$$\text{Then } 2lA_0 = \int_{-l}^{-\frac{l}{2}} \frac{l}{4} dx + \int_{-\frac{l}{2}}^{\frac{l}{2}} \frac{x^2}{l} dx + \int_{\frac{l}{2}}^l \frac{l}{4} dx = \frac{l^2}{3}; \therefore A_0 = \frac{l}{6}; \text{ and}$$

$$\int_{-l}^l A_p \cos^2 \frac{p\pi x}{l} dx = \int_{-l}^{-\frac{l}{2}} \frac{l}{4} \cos \frac{p\pi x}{l} dx + \int_{-\frac{l}{2}}^{\frac{l}{2}} \frac{x^2}{l} \cos \frac{p\pi x}{l} dx + \int_{\frac{l}{2}}^l \frac{l}{4} \cos \frac{p\pi x}{l} dx;$$

whence $A_p = \frac{2l}{p^2\pi^2} \left(\cos \frac{p\pi}{2} - \frac{2}{p\pi} \sin \frac{p\pi}{2} \right)$, giving

$$f(x) = \frac{l}{6} + \frac{2l}{\pi^2} \sum_1^{\infty} \left(\frac{1}{p^2} \cos \frac{p\pi}{2} - \frac{2}{\pi p^3} \sin \frac{p\pi}{2} \right) \cos \frac{p\pi x}{l},$$

and the graph is composed of equal arcs of a parabola and straight lines of length $\frac{l}{2}$

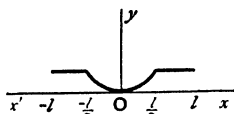

Fig. 469

which form prolongations of their latera recta, one cycle being exhibited in Fig. 469.

1614. Further Remarks.

Any series containing only cosines of multiples of x , as $A_0 + \sum_1^{\infty} A_p \cos px$, being unaffected by a change of sign of x , must have a graph for which

the y -axis is an axis of symmetry. Any series containing only sines of multiples of x , as $\sum_1^{\infty} B_p \sin px$, changes sign with x , and the origin is therefore a centre of symmetry of the graph. Therefore if it be required to construct a series which shall represent a discontinuous system of lines or arcs of curves for which neither kind of symmetry exists, it will be necessary to assume the most general form of Fourier Series, viz.

$$A_0 + \sum_1^{\infty} A_p \cos px + \sum_1^{\infty} B_p \sin px$$

as the representative form.

1615. (4) Devise a series whose graph shall agree with

$y = c$ from 0 to a , from b to $b+a$, from $2b$ to $2b+a$, etc. } and so on,
and $y = c'$ from a to b , from $b+a$ to $2b$, from $2b+a$ to $3b$, etc., } ($a < b$).

Here there is no symmetry with regard to the origin or the y -axis. The period is b .

Assume
$$f(x) = A_0 + \sum_1^{\infty} A_p \cos \frac{2p\pi x}{b} + \sum_1^{\infty} B_p \sin \frac{2p\pi x}{b},$$

so that the series is unaltered when x is increased by b , $2b$, $3b$, etc. We have

$$A_0 b = \int_0^a c \, dx + \int_a^b c' \, dx = ca + c'(b-a); \quad \therefore A_0 = (c-c') \frac{a}{b} + c',$$

$$A_p \frac{b}{2} = \int_0^a c \cos \frac{2p\pi x}{b} \, dx + \int_a^b c' \cos \frac{2p\pi x}{b} \, dx; \quad \therefore A_p = \frac{c-c'}{\pi p} \sin \frac{2p\pi a}{b},$$

$$B_p \frac{b}{2} = \int_0^a c \sin \frac{2p\pi x}{b} \, dx + \int_a^b c' \sin \frac{2p\pi x}{b} \, dx; \quad \therefore B_p = \frac{c-c'}{\pi p} \operatorname{vers} \frac{2p\pi a}{b};$$

$$\begin{aligned} \therefore y \equiv f(x) &= (c-c') \frac{a}{b} + c' + \frac{c-c'}{\pi} \sum_1^{\infty} \frac{1}{p} \sin \frac{2p\pi a}{b} \cos \frac{2p\pi x}{b} \\ &\quad + \frac{c-c'}{\pi} \sum_1^{\infty} \frac{1}{p} \operatorname{vers} \frac{2p\pi a}{b} \sin \frac{2p\pi x}{b}. \end{aligned}$$

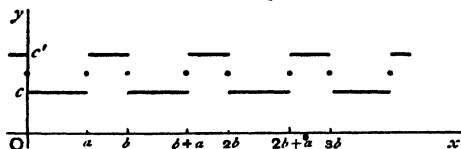

Fig. 470.

It will be seen that at the values $x=a$ or $x=b$ the series becomes $\frac{c+c'}{2}$ by virtue of the result

$$\frac{1}{1} \sin \theta + \frac{1}{2} \sin 2\theta + \frac{1}{3} \sin 3\theta + \dots = \frac{\pi - \theta}{2} \quad (0 < \theta < 2\pi).$$

The graph is represented in Fig. 470.

PROBLEMS.

1. Show that from $x=0$ to $x=\pi$ exclusive

$$\frac{\pi}{4} \cos x = \frac{2}{1 \cdot 3} \sin 2x + \frac{4}{3 \cdot 5} \sin 4x + \frac{6}{5 \cdot 7} \sin 6x + \dots \\ + \frac{2n}{(2n-1)(2n+1)} \sin 2nx + \dots,$$

and examine what is the sum of the series for other values of x . Show by a graph the nature of the series for all values of x .

2. Show that $\frac{\pi}{4} \sin x = \frac{1}{2} \cos 2x - \frac{\cos 4x}{3 \cdot 5} + \frac{\cos 6x}{5 \cdot 7} - \dots$, $0 < x < \pi$.

Show by a graph the nature of the series for all values of x . Show also that this result may be derived from that of question 1 or *vice versa*.

3. Establish the result $\frac{\pi}{4} = \sin x + \frac{1}{3} \sin 3x + \frac{1}{5} \sin 5x + \dots$ from 0 to π exclusive.

Draw a complete graph of $y = \sum_0^{\infty} \frac{\sin(2p+1)x}{2p+1}$.

4. Prove that ($0 < x < \pi$)

$$(i) \frac{\pi}{2} e^{ax} = -\frac{1}{2a} - \frac{a \cos x}{a^2+1^2} - \frac{a \cos 2x}{a^2+2^2} - \dots + e^{a\pi} \left(\frac{1}{2a} - \frac{a \cos x}{a^2+1^2} + \frac{a \cos 2x}{a^2+2^2} - \dots \right).$$

$$(ii) \frac{\pi}{2} e^{ax} = \frac{\sin x}{a^2+1^2} + \frac{2 \sin 2x}{a^2+2^2} + \frac{3 \sin 3x}{a^2+3^2} + \dots + e^{a\pi} \left(\frac{\sin x}{a^2+1^2} - \frac{2 \sin 2x}{a^2+2^2} + \frac{3 \sin 3x}{a^2+3^2} - \dots \right).$$

5. Prove that ($-\pi < x < \pi$)

$$(i) \frac{\pi}{2} \cdot \frac{\sinh ax}{\sinh a\pi} = \frac{\sin x}{a^2+1^2} - \frac{2 \sin 2x}{a^2+2^2} + \frac{3 \sin 3x}{a^2+3^2} - \dots,$$

$$(ii) \frac{\pi}{2} \cdot \frac{\cosh ax}{\sinh a\pi} = \frac{1}{2a} - \frac{a \cos x}{a^2+1^2} + \frac{a \cos 2x}{a^2+2^2} - \frac{a \cos 3x}{a^2+3^2} + \dots,$$

and (iii) $\frac{\pi}{2a} \cdot \frac{\cosh a(\pi-x)}{\sinh a\pi} = \frac{1}{2a^2} + \frac{\cos x}{a^2+1^2} + \frac{\cos 2x}{a^2+2^2} + \frac{\cos 3x}{a^2+3^2} + \dots$, ($0 < x < 2\pi$).

6. Prove that, provided a be not an integer, and ($-\pi < x < \pi$),

$$\frac{\pi}{2} \cdot \frac{\sin ax}{\sin a\pi} = \frac{\sin x}{1^2-a^2} - \frac{2 \sin 2x}{2^2-a^2} + \frac{3 \sin 3x}{3^2-a^2} - \frac{4 \sin 4x}{4^2-a^2} + \dots$$

7. Draw a graph of $y = \frac{1}{2a^2} + \sum_1^{\infty} \frac{\cos px}{p^2+a^2}$.

8. Exhibit graphically the nature of the curve $y = \sum_1^{\infty} \frac{\cos 2px}{4p^2-1}$ for all values of x .

9. Deduce other series from Examples 1, 2, 3, 4, 5 by differentiation and by integration.

10. Find a function of x in a series of sines of multiples of x which shall be equal to c_1 from 0 to a_1 , c_2 from a_1 to a_2 , c_3 from a_2 to a_3 , and trace the graph for all values of x .

11. Find a function of x which shall be equal to c_1 from 0 to a_1 , c_2 from a_1 to a_2 , c_3 from a_2 to a_3 , c_1 from a_3 to $a_3 + a_1$, c_2 from $a_3 + a_1$ to $a_3 + a_2$, c_3 from $a_3 + a_2$ to $2a_3$, and so on. Trace the graph completely.

12. Trace the complete graph of $\frac{y}{c} = \sum_1^{\infty} \frac{1}{n} \text{vers} \frac{n\pi a}{l} \sin \frac{n\pi x}{l}$ for all real values of x .

13. Show that if $f(x) = x$, a , $\pi - x$ in the respective intervals 0 to a , a to $\pi - a$ and $\pi - a$ to π , then

$$\frac{\pi}{4} f(x) = \sum_0^{\infty} \frac{\sin(2p+1)a \sin(2p+1)x}{(2p+1)^2},$$

and give a geometrical interpretation.

14. Prove that

$$\frac{x(\pi^2 - x^2)}{12} = \frac{\sin x}{1^3} - \frac{\sin 2x}{2^3} + \frac{\sin 3x}{3^3} - \dots, \quad (-\pi < x < \pi),$$

and examine the graph of $y = \sum_1^{\infty} (-1)^{p-1} \frac{\sin px}{p^3}$ for all values of x .

15. Show that

$$f(x) = \frac{1}{4l} \int_0^l f(\xi) d\xi + \frac{1}{2l} \sum_{p=1}^{\infty} f(\xi) \cos \frac{2p\pi}{2l} (\xi - x) d\xi, \quad (0 < x < l);$$

but that if $x=0$, this expression = $\frac{1}{2} f(0)$, and if $x=l$, $\frac{1}{2} f(l)$.

16. Show that

$$(a) \frac{1}{l} \sum_{p=1}^{\infty} \int_0^l f(\xi) \cos \frac{(2p-1)\pi}{2l} (\xi - x) d\xi = f(x), \quad (0 < x < l);$$

$$\text{or} = \frac{1}{2} f(0), \quad (x=0); \quad \text{or} = \frac{1}{2} f(l), \quad (x=l).$$

$$(b) \frac{1}{l} \sum_{p=1}^{\infty} \int_0^l f(\xi) \cos \frac{(2p-1)\pi}{2l} (\xi + x) d\xi = 0, \quad (0 < x < l);$$

$$\text{or} = \frac{1}{2} f(0), \quad (x=0); \quad \text{or} = -\frac{1}{2} f(l), \quad (x=l).$$

[TODHUNTER, I.C., p. 306.]

17. Assuming that $f(x)$ can be expanded in a Fourier's series of sines and cosines of multiples of x in the interval $\pi > x > -\pi$, obtain a series of sines only which shall represent the function in the interval $\pi > x > 0$.

If $f(x) = 0, 1, 0$ in the respective intervals $(l/2 - b > x > 0)$, $(l/2 + b > x > l/2 - b)$ and $(l > x > l/2 + b)$, prove that throughout the interval $(l > x > 0)$

$$f(x) = \frac{4}{\pi} \sum_{n=0}^{\infty} \frac{(-1)^n}{2n+1} \sin \frac{(2n+1)\pi b}{l} \sin \frac{(2n+1)\pi x}{l}.$$

What are the values of the series when x has the values $l/2 - b$ and $l/2 + b$?

18. Show that

$$\frac{2}{l} \sum_{p=1}^{\infty} \cos \frac{(2p-1)\pi}{2l} x \int_0^l f(\xi) \cos \frac{(2p-1)\pi}{2l} \xi d\xi = f(x), \quad (0 < x < l);$$

or $= 0, \quad (x = l).$

$$\frac{2}{l} \sum_{p=1}^{\infty} \sin \frac{(2p-1)\pi}{2l} x \int_0^l f(\xi) \sin \frac{(2p-1)\pi}{2l} \xi d\xi = f(x), \quad (0 < x < l);$$

or $= 0, \quad (x = 0).$

Apply these theorems in the case $f(x) = x$.

[TODHUNTER, I.C., p. 307.]

Exhibit by means of graphs the values of the above series for values of x beyond the limits 0 and l .

Also examine in each case the effect of a discontinuity at a point c between 0 and l in the value of the function $f(\xi)$.

19. Show that a function defined as equal to l when $-2l < x < -l$; $= -x$ when $-l < x < 0$; $= x$ when $0 < x < l$; $= l$ when $l < x < 2l$; can be represented by

$$\frac{3l}{4} - \frac{4l}{\pi^2} \sum_{m=0}^{\infty} \frac{1}{(2m+1)^2} \cos(2m+1) \frac{\pi x}{2l} - \frac{2l}{\pi^2} \sum_{m=0}^{\infty} \frac{1}{(2m+1)^2} \cos(2m+1) \frac{\pi x}{l}.$$

[I.C.S., 1899.]

20. Prove that the graph of the function $f(x) = \frac{2}{\pi} \int_0^{\infty} \frac{\sin^3 t \cos xt}{t} dt$ consists of parts of the lines $4y = -1, y = 0, 2y = 1$, together with four isolated points.

[MATH. TRIP. II., 1916.]

21. If the function defined by $y = x^2$ from 0 to $\frac{1}{2}\pi$ and by $y = 0$ from $\frac{1}{2}\pi$ to π be represented by a series of sines of multiples of x , show that the coefficient of $\sin nx$ is

$$\left(\frac{4}{\pi n^3} - \frac{\pi}{2n} \right) \cos \frac{1}{2} n\pi + \frac{2}{n^2} \sin \frac{1}{2} n\pi - \frac{4}{\pi n^3}.$$

To what value does the series converge at the point $x = \frac{1}{2}\pi$? Sketch the graph of the function represented by the series for values of x not restricted to lie between 0 and π ; and also indicate the graph of the cosine series which represents the same function in the interval 0 to π .

[MATH. TRIP. II., 1916.]

CHAPTER XXXV. SECTION II.

DIRICHLET'S INVESTIGATION.

1616. Fourier's Formulae. Dirichlet's Investigation.

If $\phi(x)$ be a single-valued finite and continuous function of x which remains positive and either constant or continually decreasing throughout the whole range of integration from $x=0$ to $x=h$, where $0 < h \leq \pi/2$, then will

$$\lim_{\omega \rightarrow \infty} \int_0^h \frac{\sin \omega x}{\sin x} \phi(x) dx = \frac{\pi}{2} \phi(0).$$

This result is due to Fourier. Separating the integration range 0 to h into intervals

$$0 \text{ to } \frac{\pi}{\omega}, \quad \frac{\pi}{\omega} \text{ to } \frac{2\pi}{\omega}, \dots (n-1) \frac{\pi}{\omega} \text{ to } \frac{n\pi}{\omega}, \quad \frac{n\pi}{\omega} \text{ to } h,$$

where $\frac{n\pi}{\omega}$ is the greatest multiple of $\frac{\pi}{\omega}$ contained in h , we have

$$\int_0^h \frac{\sin \omega x}{\sin x} \phi(x) dx = \left\{ \int_0^{\frac{\pi}{\omega}} + \int_{\frac{\pi}{\omega}}^{\frac{2\pi}{\omega}} + \dots + \int_{\frac{r\pi}{\omega}}^{\frac{(r+1)\pi}{\omega}} + \int_{\frac{(r+1)\pi}{\omega}}^{\frac{(r+2)\pi}{\omega}} + \dots + \int_{\frac{(n-1)\pi}{\omega}}^{\frac{n\pi}{\omega}} + \int_{\frac{n\pi}{\omega}}^h \right\} \frac{\sin \omega x}{\sin x} \phi(x) dx. \dots (1)$$

Now as x increases from $r\pi/\omega$ to $(r+1)\pi/\omega$, ωx increases by π . Hence $\sin \omega x$ in this interval is of opposite sign to the value of $\sin \omega x$ in the next interval. But $\sin x$ and $\phi(x)$ retain the same sign. Hence the several terms in the above series are alternately positive and negative.

Again comparing corresponding elements in $\int_{\frac{r\pi}{\omega}}^{\frac{(r+1)\pi}{\omega}} () dx$ and $\int_{\frac{(r+1)\pi}{\omega}}^{\frac{(r+2)\pi}{\omega}} () dx$, write $x + \frac{\pi}{\omega}$ for x in the second, which then becomes

$$- \int_{\frac{r\pi}{\omega}}^{\frac{(r+1)\pi}{\omega}} \frac{\sin \omega x}{\sin (x + \pi/\omega)} \phi(x + \pi/\omega) dx.$$

And since x has increased to $x + \pi/\omega$, but is still $< \pi/2$, $\sin(x + \pi/\omega)$ is $> \sin x$, whilst $\phi(x + \pi/\omega) > \phi(x)$, the element in the second integral is numerically less than the corresponding element in the first.

Hence the several terms of (1) are (a) of alternate sign, (b) of decreasing numerical magnitude.

Putting $\omega x = z$,

$$\begin{aligned} Lt_{\omega \rightarrow \infty} \int_{r\pi}^{(r+1)\pi} \frac{\sin \omega x}{\sin x} \phi(x) dx &= Lt_{\omega \rightarrow \infty} \int_{r\pi}^{(r+1)\pi} \frac{\sin z}{\omega \sin z/\omega} \phi(z/\omega) dz \\ &= \phi(0) \int_{r\pi}^{(r+1)\pi} \frac{\sin z}{z} dz. \quad (\text{See Art. 1902.}) \end{aligned}$$

Hence the sum of the first r terms of (1) becomes

$$\phi(0) \left[\int_0^\pi + \int_\pi^{2\pi} + \dots + \int_{(r-1)\pi}^{r\pi} \right] \frac{\sin z}{z} dz = \phi(0) \int_0^{r\pi} \frac{\sin z}{z} dz = \frac{\pi}{2} \phi(0)$$

when r is infinite.

And for the remaining terms from

$$\int_{r\pi}^{\frac{(r+1)\pi}{\omega}} \frac{\sin \omega x}{\sin x} \phi(x) dx \quad \text{to} \quad \int_{\frac{(n-1)\pi}{\omega}}^{\frac{n\pi}{\omega}} \frac{\sin \omega x}{\sin x} \phi(x) dx,$$

the interval of each is infinitesimally small, and the integrands are finite. Each integral is therefore infinitesimally small, they are of alternate sign and each numerically less than the preceding one. Hence their sum is less than the first of the group, which is itself infinitesimally small.

Again, as to the final integral $\int_{\frac{n\pi}{\omega}}^h \frac{\sin \omega x}{\sin x} \phi(x) dx$, it is integrated over an infinitesimal interval with a finite integrand, and therefore also vanishes.

Thus we have

$$Lt_{\omega \rightarrow \infty} \int_0^h \frac{\sin \omega x}{\sin x} \phi(x) dx = \frac{\pi}{2} \phi(0),$$

where $0 < h > \frac{\pi}{2}$ under the special conditions stated as to $\phi(x)$.

The method adopted in this proof is due to Dirichlet. It is given by Bertrand, *Calc. Int.*, p. 228.

1617. If $\phi(x)$ becomes negative but not numerically greater than a definite positive constant C , remaining finite and continuous as before, then since $\phi(x)+C$ is positive and decreasing, we have

$$Lt_{\omega \rightarrow \infty} \int_0^h \frac{\sin \omega x}{\sin x} [\phi(x)+C] dx = [\phi(0)+C] \frac{\pi}{2}.$$

But the theorem is also true for a function which remains constant and equal to C . Hence subtracting,

$$Lt_{\omega \rightarrow \infty} \int_0^h \frac{\sin \omega x}{\sin x} \phi(x) dx = \frac{\pi}{2} \phi(0).$$

This has therefore been now proved whether $\phi(x)$ be positive or negative, provided it is either constant or decreasing so long as it remains finite and continuous between the limits.

1618. Further, if $\phi(x)$ be an *increasing* function, $-\phi(x)$ is a *decreasing* function to which the theorem is applicable, and therefore

$$Lt_{\omega \rightarrow \infty} \int_0^h \frac{\sin \omega x}{\sin x} \{-\phi(x)\} dx = \frac{\pi}{2} \{-\phi(0)\},$$

whence
$$Lt_{\omega \rightarrow \infty} \int_0^h \frac{\sin \omega x}{\sin x} \phi(x) dx = \frac{\pi}{2} \phi(0),$$

whether $\phi(x)$ be continually either increasing or decreasing between the limits.

1619. Since the formula established is independent of h , taking p and q any two quantities between 0 and $\pi/2$, we have

$$Lt_{\omega \rightarrow \infty} \int_0^p \frac{\sin \omega x}{\sin x} \phi(x) dx = \frac{\pi}{2} \phi(0) = Lt_{\omega \rightarrow \infty} \int_0^q \frac{\sin \omega x}{\sin x} \phi(x) dx.$$

Hence if $F(x)$ be any function of x , continuous and coincident with $\phi(x)$ for the portion of $\phi(x)$ between q and p ,

$$Lt_{\omega \rightarrow \infty} \int_q^p \frac{\sin \omega x}{\sin x} F(x) dx = 0,$$

and here it is supposed that from q to p , $F(x)$ is always increasing or always decreasing, for it is coincident with $\phi(x)$ throughout that interval.

1620. **Existence of a Finite Number of Maxima and Minima.**

Suppose that there are a finite number of maxima and minima on the graph of $y=\phi(x)$ between $x=0$ and $x=h$, say at $x=x_1, x_2, x_3, \dots x_n$. Then when $\omega \rightarrow \infty$

$$Lt \int_0^h \frac{\sin \omega x}{\sin x} \phi(x) dx = Lt \left[\int_0^{x_1} + \int_{x_1}^{x_2} + \dots + \int_{x_n}^h \right] \frac{\sin \omega x}{\sin x} \phi(x) dx.$$

Now $\phi(x)$ is

continually increasing or continually decreasing from 0 to x_1 ,
continually decreasing or continually increasing from x_1 to x_2 ,
continually increasing or continually decreasing from x_2 to x_3 ,
etc.

The first term therefore contributes $\frac{\pi}{2} \phi(0)$. Each of the others contributes nothing by Art. 1619. So that if the number of maxima and minima be finite, the Fourier formula still holds good.

1621. **Existence of a Finite Number of Discontinuities.**

Finally, suppose a discontinuity in $\phi(x)$ occurs at a point $x=x_1 (< h)$, where the function changes abruptly from $\phi(x_1)$ to $\psi(x_1)$, remaining finite and $\psi(x)$ retaining the property possessed by $\phi(x)$ as to continual increase or decrease throughout the remainder of the range of integration. Then

$$\begin{aligned} Lt_{\omega \rightarrow \infty} \int_0^h \frac{\sin \omega x}{\sin x} \phi(x) dx \\ = Lt_{\omega \rightarrow \infty} \int_0^{x_1} \frac{\sin \omega x}{\sin x} \phi(x) dx + Lt_{\omega \rightarrow \infty} \int_{x_1}^h \frac{\sin \omega x}{\sin x} \psi(x) dx = \frac{\pi}{2} \phi(0) + 0. \end{aligned}$$

Thus each discontinuity introduces a zero term, and provided the number of such discontinuities be finite between 0 and h , their aggregate contributes nothing to the integral.

1622. **Generalised Restatement of the Theorem.**

We may now restate the theorem thus:

Let $\phi(x)$ be any function of x with any finite number of discontinuities and any finite number of maxima and minima between $x=0$ and $x=h$, where h is positive, not infinitesimally small, and not greater than $\pi/2$; then

$$Lt_{\omega \rightarrow \infty} \int_0^h \frac{\sin \omega x}{\sin x} \phi(x) dx = \frac{\pi}{2} \phi(0).$$

1623. Geometrical View of the Result.

Drawing the graph of $y = \sin \omega x / \sin x$, the curve has a large maximum, viz. ω , at $x=0$; and crossing the x -axis at $x = \pi/\omega$, $2\pi/\omega$, $3\pi/\omega$, etc., there are successive minima and maxima, their positions being given by $\tan \omega x = \omega \tan x$.

Since $\sin \omega x$ lies between ± 1 and goes through a cycle of its numerical changes in each of the above intervals, whilst $\sin x$ is increasing throughout the whole range from $x=0$ to $x = \frac{\pi}{2}$, the excursions of the graph to one side or the other of the x -axis diminish in extent, and these subsidiary maxima and minima are relatively unimportant. The multiplication of the function by $\phi(x)$ alters the magnitude and position of the maxima and minima ordinates, but leaves the general characteristic appearance of the graph unchanged (Fig. 471).

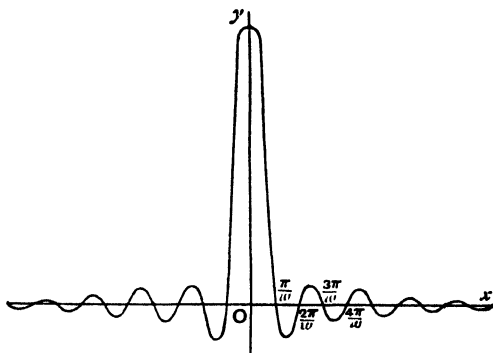

Fig. 471.

The geometrical interpretation of the formula of Art. 1622 is then as follows:

Let the graph of $y = \phi(x) \frac{\sin \omega x}{\sin x}$ be drawn starting from $x=0$ and extending as far as $x=h$, and also the graph of $y = \phi(x)$ extending as far as $x = \pi/2$. Let the areas enclosed by the successive portions of the former bounded by the x -axis, and, for the principal maximum, by the y -axis, and lying alternately above and below the x -axis be A_1, A_2, A_3, A_4 , etc., and let B be the area of the rectangle of which two

adjacent sides are the initial ordinate of the second graph, viz. $\phi(0)$ and the length $\frac{\pi}{2}$; then when ω is indefinitely increased $A_1 - A_2 + A_3 - A_4 + \dots$ tends to the limit B .

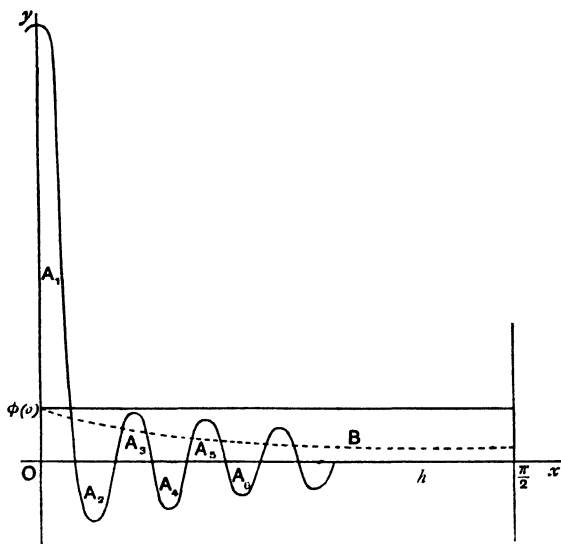

Fig. 472.

1624. **Extension of Range of Integration.**

If the range of integration be extended beyond $\pi/2$, and h lies between $n\pi$ and $(n+1)\pi$, we may break up the whole range into sub-ranges of extent $\pi/2$ as far as $n\pi$, and we have

$$\int_0^h \frac{\sin \omega x}{\sin x} \phi(x) dx = \left\{ \int_0^{\frac{\pi}{2}} + \int_{\frac{\pi}{2}}^{\frac{3\pi}{2}} + \dots + \int_{(2n-1)\frac{\pi}{2}}^{2n\frac{\pi}{2}} + \int_{n\pi}^h \right\} \frac{\sin \omega x}{\sin x} \phi(x) dx.$$

In the second, third, ... $2n^{\text{th}}$ integrals replace x successively by $\pi - y$, $\pi + y$, $2\pi - y$, ... $n\pi - y$.

If we take ω to be an odd integer, these become

$$\int_{\frac{\pi}{2}}^0 \frac{\sin \omega(\pi - y)}{\sin(\pi - y)} \phi(\pi - y)(-dy), \quad \int_0^{\frac{\pi}{2}} \frac{\sin \omega(\pi + y)}{\sin(\pi + y)} \phi(\pi + y) dy,$$

$$\int_{\frac{\pi}{2}}^0 \frac{\sin \omega(2\pi - y)}{\sin(2\pi - y)} \phi(2\pi - y)(-dy), \text{ etc.,}$$

$$i.e. \int_0^{\frac{\pi}{2}} \frac{\sin \omega x}{\sin x} \phi(\pi-x) dx, \quad \int_0^{\frac{\pi}{2}} \frac{\sin \omega x}{\sin x} \phi(\pi+x) dx,$$

$$\int_0^{\frac{\pi}{2}} \frac{\sin \omega x}{\sin x} \phi(2\pi-x) dx, \text{ etc. ;}$$

$$\text{whence } \int_0^{n\pi} \frac{\sin \omega x}{\sin x} \phi(x) dx$$

$$= \pi \left[\frac{1}{2} \phi(0) + \phi(\pi) + \phi(2\pi) + \dots + \phi(\overline{n-1}\pi) + \frac{1}{2} \phi(n\pi) \right].$$

$$\text{As regards the final term } \int_{n\pi}^h \frac{\sin \omega x}{\sin x} \phi(x) dx,$$

(a) if h lies between $n\pi$ and $n\pi + \pi/2$, inclusive of the latter, put $x = n\pi + y$ and $h = n\pi + h'$, where $h' \geq \frac{\pi}{2}$. The final integral then becomes in the limit

$$\begin{aligned} Lt_{\omega \rightarrow \infty} \int_0^{h'} \frac{\sin \omega(n\pi+y)}{\sin(n\pi+y)} \phi(n\pi+y) dy \\ = Lt_{\omega \rightarrow \infty} \int_0^{h'} \frac{\sin \omega x}{\sin x} \phi(n\pi+x) dx = \frac{\pi}{2} \phi(n\pi); \end{aligned}$$

(b) and if h lies between $n\pi + \pi/2$ and $(n+1)\pi$, the integral may be written $Lt_{\omega \rightarrow \infty} \left(\int_{n\pi}^{n\pi+\frac{\pi}{2}} + \int_{n\pi+\frac{\pi}{2}}^h \right) \left\{ \frac{\sin \omega x}{\sin x} \phi(x) dx \right\}$; and putting $x = n\pi + y$ in the first and $(n+1)\pi - y$ in the second, the first becomes $\frac{\pi}{2} \phi(n\pi)$, as has been seen, and the second becomes

$$\begin{aligned} Lt_{\omega \rightarrow \infty} \int_{\frac{\pi}{2}}^{(n+1)\pi-h} \frac{\sin \omega \{(n+1)\pi-y\}}{\sin \{(n+1)\pi-y\}} \phi \{(n+1)\pi-y\} (-dy) \\ = Lt_{\omega \rightarrow \infty} \int_{h'}^{\pi} \frac{\sin \omega x}{\sin x} \phi \{(n+1)\pi-x\} dx, \end{aligned}$$

where $h' = (n+1)\pi - h$, which is positive and $\geq \frac{\pi}{2}$. Therefore this limit vanishes by Art. 1619. Hence in either case the contribution of the final integral is $\frac{\pi}{2} \phi(n\pi)$. But if $h = n\pi$ the contribution is zero.

Hence in the limit when ω is indefinitely increased,

$$\begin{aligned} Lt_{\omega \rightarrow \infty} \int_0^h \frac{\sin \omega x}{\sin x} \phi(x) dx &= Lt_{\omega \rightarrow \infty} \int_0^{\frac{\pi}{2}} \frac{\sin \omega x}{\sin x} \{ \phi(x) + \phi(\pi-x) \\ &+ \phi(\pi+x) + \phi(2\pi-x) + \dots + \phi(n\pi-x) \} dx + \int_{n\pi}^h \frac{\sin \omega x}{\sin x} \phi(x) dx \\ &= \frac{\pi}{2} [\phi(0) + 2\phi(\pi) + 2\phi(2\pi) + \dots + 2\phi\{(n-1)\pi\} + 2\phi(n\pi)]. \end{aligned}$$

But if $h = n\pi$ the last term in the square bracket is to be $\phi(n\pi)$.

This therefore is the extended form of Fourier's formula for a range 0 to h , where h lies between $n\pi$ and $(n+1)\pi$, and ω is an *indefinitely large odd integer* with the same conditions for $\phi(x)$ as before stated.

If ω became infinite as an *even integer*, the signs would be alternately + and -.

If there be discontinuities in the value of $\phi(x)$ in the range 0 to h , and if the starting values of $\phi(x)$ as x begins each of its marches 0 to $\frac{\pi}{2}$, $\frac{\pi}{2}$ to $\frac{2\pi}{2}$, $\frac{2\pi}{2}$ to $\frac{3\pi}{2}$, $\frac{3\pi}{2}$ to $\frac{4\pi}{2}$, etc., be respectively $f_1(x)$, $f_2(x)$, $f_3(x)$, $f_4(x)$, etc., the formula must be amended to

$$\begin{aligned} \frac{\pi}{2} \{ f_1(0) + f_2(\pi) + f_3(\pi) + f_4(2\pi) + f_5(2\pi) + f_6(3\pi) + f_7(3\pi) \\ + \dots + f_{2n}(n\pi) + f_{2n+1}(n\pi) \}, \end{aligned}$$

when ω becomes infinite as an odd integer and the number of discontinuities between 0 and h is supposed finite.

1625. If a and b be two positive quantities, $a > b$ and $m\pi < a < (m+1)\pi$, $n\pi < b < (n+1)\pi$, then

$$\begin{aligned} Lt_{\omega \rightarrow \infty} \int_0^a \frac{\sin \omega x}{\sin x} \phi(x) dx &= \pi \left[\frac{1}{2} \phi(0) + \phi(\pi) + \phi(2\pi) + \dots + \phi(m\pi) \right] \\ &= \pi E_m, \text{ say,} \end{aligned}$$

and

$$\begin{aligned} Lt_{\omega \rightarrow \infty} \int_0^b \frac{\sin \omega x}{\sin x} \phi(x) dx &= \pi \left[\frac{1}{2} \phi(0) + \phi(\pi) + \phi(2\pi) + \dots + \phi(n\pi) \right] \\ &= \pi E_n, \text{ say.} \end{aligned}$$

$$\text{Then } Lt_{\omega \rightarrow \infty} \int_b^a \frac{\sin \omega x}{\sin x} \phi(x) dx = \pi(E_m - E_n).$$

If $a - b \geq 2\pi$, so that $a \geq (n+1)\pi + 2\pi$, i.e. $\geq (n+3)\pi$, the limit is $\pi[\phi\{(n+1)\pi\} + \phi\{(n+2)\pi\}]$, ($n > 0$).

If $b < \pi$, then $a < 3\pi$, and the limit is $\pi[\phi(\pi) + \phi(2\pi)]$.

Still supposing a and b both positive, and

$$a > b \quad \text{and} \quad n\pi < a < (n+1)\pi, \quad n\pi < b < (n+1)\pi,$$

consider $Lt_{\omega \rightarrow \infty} \int_0^{-b} \frac{\sin \omega x}{\sin x} \phi(x) dx$; write $x = -y$. Then the integral becomes

$$-Lt_{\omega \rightarrow \infty} \int_0^b \frac{\sin \omega y}{\sin y} \phi(-y) dy = -\pi \left[\frac{1}{2} \phi(0) + \phi(-\pi) + \phi(-2\pi) \right. \\ \left. + \dots + \phi(-n\pi) \right] = -\pi E_{-n}, \text{ say.}$$

$$\text{Similarly } Lt_{\omega \rightarrow \infty} \int_0^{-a} \frac{\sin \omega x}{\sin x} \phi(x) dx = -\pi E_{-m}.$$

Thus we have

$$\left. \begin{aligned} Lt \int_b^a \frac{\sin \omega x}{\sin x} \phi(x) dx &= \pi (E_m - E_n), \\ Lt \int_{-b}^a \frac{\sin \omega x}{\sin x} \phi(x) dx &= Lt \left[\int_0^a - \int_0^{-b} \right] \frac{\sin \omega x}{\sin x} \phi(x) dx = \pi (E_m + E_{-n}), \\ Lt \int_b^{-a} \frac{\sin \omega x}{\sin x} \phi(x) dx &= Lt \left[\int_0^{-a} - \int_0^b \right] \frac{\sin \omega x}{\sin x} \phi(x) dx = -\pi (E_{-m} + E_n), \\ Lt \int_{-b}^{-a} \frac{\sin \omega x}{\sin x} \phi(x) dx &= Lt \left[\int_0^{-a} - \int_0^{-b} \right] \frac{\sin \omega x}{\sin x} \phi(x) dx = -\pi (E_{-m} - E_{-n}), \end{aligned} \right\} m > n > 0.$$

In the case $0 < b < a < \pi$,

$$\left. \begin{aligned} Lt \int_b^a \frac{\sin \omega x}{\sin x} \phi(x) dx &= \pi \left[\frac{1}{2} \phi(0) - \frac{1}{2} \phi(0) \right] = 0, \\ Lt \int_{-b}^a \frac{\sin \omega x}{\sin x} \phi(x) dx &= \pi \left[\frac{1}{2} \phi(0) + \frac{1}{2} \phi(0) \right] = \pi \phi(0), \\ Lt \int_b^{-a} \frac{\sin \omega x}{\sin x} \phi(x) dx &= \pi \left[-\frac{1}{2} \phi(0) - \frac{1}{2} \phi(0) \right] = -\pi \phi(0), \\ Lt \int_{-b}^{-a} \frac{\sin \omega x}{\sin x} \phi(x) dx &= \pi \left[-\frac{1}{2} \phi(0) + \frac{1}{2} \phi(0) \right] = 0, \end{aligned} \right\}$$

i.e. if the limits be of the same sign the result is zero; if the limits be of opposite signs the result is $\pi\phi(0)$ or $-\pi\phi(0)$, according as the upper limit is positive or negative.

1626. Application to the Evaluation of Fourier's Series.

Taking the identity $\frac{\sin(2n+1)\theta/2}{\sin\theta/2} = 1 + 2\sum_1^n \cos p\theta$, write therein $\theta = \xi - x = 2y$, $2n+1 = \omega$; multiply by $f(\xi)$ and integrate with regard to ξ from β to α , where $\alpha - \beta > 2\pi$. We have

$$\int_{\beta}^{\alpha} f(\xi) d\xi + 2\sum_1^n \int_{\beta}^{\alpha} f(\xi) \cos p(\xi-x) d\xi = 2 \int_{\frac{\beta-x}{2}}^{\frac{\alpha-x}{2}} \frac{\sin \omega y}{\sin y} f(x+2y) dy;$$

and increasing n without limit, $\omega \rightarrow \infty$ and

$$\frac{1}{2} \int_{\beta}^{\alpha} f(\xi) d\xi + \sum_1^{\infty} \int_{\beta}^{\alpha} f(\xi) \cos p(\xi-x) d\xi = Lt \int_{\frac{\beta-x}{2}}^{\frac{\alpha-x}{2}} \frac{\sin \omega y}{\sin y} f(x+2y) dy.$$

For the right-hand side we have the following cases:

Case.	Upper Limit.	Lower Limit.	Result.	}	$\alpha - \beta < 2\pi$.
$\alpha > x > \beta$	+	-	$\pi f(x)$		
$\beta + 2\pi > x > \alpha > \beta$	-	-	0		
$\alpha > \beta > x > \alpha - 2\pi$	+	+	0		
$x = \beta$	+	0	$\frac{\pi}{2} f(\beta)$		
$x = \alpha$	0	-	$\frac{\pi}{2} f(\alpha)$		

Dividing by π , we therefore have, if $\alpha - \beta < 2\pi$,

$$\left. \begin{aligned} \frac{1}{2\pi} \int_{\beta}^{\alpha} f(\xi) d\xi + \frac{1}{\pi} \sum_1^{\infty} \int_{\beta}^{\alpha} f(\xi) \cos p(\xi-x) d\xi = f(x) \text{ if } \alpha > x > \beta \\ = \frac{1}{2} f(\alpha) \text{ if } x = \alpha \\ = \frac{1}{2} f(\beta) \text{ if } x = \beta \\ = 0 \text{ if } \alpha > \beta > x > \alpha - 2\pi \\ \text{or } 2\pi + \beta > x > \alpha > \beta. \end{aligned} \right\}$$

Again, if $\alpha - \beta = 2\pi$, we have as before for the limit, $\pi f(x)$, if $\alpha > x > \beta$. But if $x = \beta$ the limit becomes

$$\begin{aligned} Lt_{\omega \rightarrow \infty} \int_0^{\pi} \frac{\sin \omega y}{\sin y} f(x+2y) dy &= \frac{\pi}{2} [f(x+2 \cdot 0) + f(x+2\pi)] \\ &= \frac{\pi}{2} [f(\beta) + f(\alpha)]; \end{aligned}$$

and if $x = a$, the limit becomes

$$\begin{aligned} Lt_{\omega \rightarrow \infty} \int_{-\pi}^0 \frac{\sin \omega y}{\sin y} f(x+2y) dy &= Lt_{\omega \rightarrow \infty} \int_0^{\pi} \frac{\sin \omega z}{\sin z} f(x-2z) dz \\ &= \frac{\pi}{2} [f(x-2 \cdot 0) + f(x-2\pi)] = \frac{\pi}{2} [f(a) + f(\beta)]; \end{aligned}$$

and dividing by π , we therefore have, if $a - \beta = 2\pi$,

$$\begin{aligned} \frac{1}{2\pi} \int_{\beta}^a f(\xi) d\xi + \frac{1}{\pi} \sum_1^{\infty} \int_{\beta}^a f(\xi) \cos p(\xi-x) d\xi &= f(x) \text{ if } a > x > \beta \\ &= \frac{1}{2} [f(a) + f(\beta)] \text{ if } x = a \text{ or } \beta. \end{aligned}$$

And these results are the same as those obtained otherwise in Art. 1601. It will be noted that this method of procedure is free from the objection of assuming that what is true within an immeasurably small distance of the limit is true in the limit. (See Art. 1601.)

For values of x which lie beyond $\beta + 2\pi$ in the one direction or $a - 2\pi$ in the other, we may proceed exactly as before in Articles 1601, 1602, etc.

1627. Cauchy's Identity.

Taking the identity used in Art. 1626, and putting

$$\theta = 2\xi \quad \text{and} \quad f(\xi) = e^{-a^2 \xi^2},$$

we have

$$\int_0^{\infty} (1 + 2 \cos 2\xi + 2 \cos 4\xi + \dots + 2 \cos 2n\xi) e^{-a^2 \xi^2} d\xi = \int_0^{\infty} \frac{\sin(2n+1)\xi}{\sin \xi} e^{-a^2 \xi^2} d\xi.$$

But $\int_0^{\infty} e^{-a^2 \xi^2} \cos 2r\xi d\xi = \frac{\sqrt{\pi}}{2a} e^{-\frac{r^2}{a^2}}$, and by Art. 1625 the limit of the right-hand side, when n is indefinitely increased, $= \frac{\pi}{2} \left(1 + 2 \sum_1^{\infty} e^{-r^2 n^2 a^2}\right)$.

$$\text{Hence} \quad \frac{\sqrt{\pi}}{2a} \left(1 + 2 \sum_1^{\infty} e^{-r^2 a^2}\right) = \frac{\pi}{2} \left(1 + 2 \sum_1^{\infty} e^{-r^2 n^2 a^2}\right);$$

and writing $a = a/\pi = 1/b$,

$$\sqrt{a} \left(1 + 2 \sum_1^{\infty} e^{-r^2 a^2}\right) = \sqrt{b} \left(1 + 2 \sum_1^{\infty} e^{-r^2 n^2 a^2}\right),$$

a curious and remarkable result due to Cauchy.

Series of the character here involved occur in the theory of Theta Functions, where $\Theta(u)$ may be defined by the equation

$$\Theta(u) = 1 - 2q \cos 2x + 2q^4 \cos 4x - 2q^9 \cos 6x + \dots,$$

where $q = e^{-\frac{K}{K'}}$ and $x = \frac{\pi u}{2K}$, K and K' having their usual significations as used in Elliptic Integrals.

1628. To prove $Lt_{\omega \rightarrow \infty} \int_0^h \frac{\sin \omega x}{x} \phi(x) dx = \frac{\pi}{2} \phi(0)$.

This limiting form follows at once by writing

$$\phi(x) = \frac{x}{\sin x} \psi(x).$$

For we then have, if $0 < h > \frac{\pi}{2}$,

$$\begin{aligned} Lt_{\omega \rightarrow \infty} \int_0^h \frac{\sin \omega x}{x} \phi(x) dx &= Lt_{\omega \rightarrow \infty} \int_0^h \frac{\sin \omega x}{\sin x} \psi(x) dx \\ &= \frac{\pi}{2} \psi(0) = \frac{\pi}{2} \phi(0), \end{aligned}$$

under the same conditions as regards $\psi(x)$ as stated in Arts. 1616 to 1622.

And further, when h has a larger range, beyond $\frac{\pi}{2}$, as in Art. 1624, we have as the limit,

$$\frac{\pi}{2} \{ \psi(0) + 2\psi(\pi) + 2\psi(2\pi) + 2\psi(3\pi) + \dots \}.$$

But $\psi(\pi) = \frac{\sin \pi}{\pi} \phi(\pi) = 0$, $\psi(2\pi) = \frac{\sin 2\pi}{2\pi} \phi(2\pi) = 0$, etc.,

so that whatever the range of integration provided h be positive and not an infinitesimal, we have

$$Lt_{\omega \rightarrow \infty} \int_0^h \frac{\sin \omega x}{x} \phi(x) dx = \frac{\pi}{2} \phi(0).$$

In the same way the result still holds good if $\phi(x)$ presents a finite number of finite discontinuities, none of which are infinitesimally near $x=0$.

1629. Graphical Illustration.

Since $Lt_{\omega \rightarrow \infty} \int_0^x \frac{\sin \omega \xi}{\xi} \phi(\xi) d\xi = \frac{\pi}{2} \phi(0)$, putting $\xi = -\eta$,

$$Lt_{\omega \rightarrow \infty} \int_0^{-x} \frac{\sin \omega \eta}{\eta} \phi(-\eta) d\eta = -\frac{\pi}{2} \phi(0);$$

and writing $\phi(-\eta) = \psi(\eta)$,

$$Lt_{\omega \rightarrow \infty} \int_0^{-x} \frac{\sin \omega \eta}{\eta} \psi(\eta) d\eta = -\frac{\pi}{2} \psi(0);$$

and the letter denoting the function ψ being immaterial, we may replace it again by ϕ , so that

$$Lt_{\omega \rightarrow \infty} \int_0^{-x} \frac{\sin \omega \xi}{\xi} \phi(\xi) d\xi = -\frac{\pi}{2} \phi(0).$$

Also if $x=0$ the limit vanishes and there is a discontinuity. Hence the graph of

$$y = L_{\omega \rightarrow \infty} \int_0^x \frac{\sin \omega \xi}{\xi} \phi(\xi) d\xi$$

is that shown in Fig. 473 consisting of two straight lines parallel to the x -axis, with an isolated point at the origin.

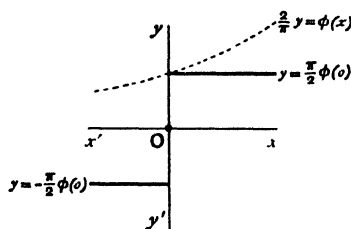

Fig. 473.

1630. Let α, β be any two positive quantities.

$$\text{Then } L_{\omega \rightarrow \infty} \int_0^{\alpha} \frac{\sin \omega \xi}{\xi} \phi(\xi) d\xi = \frac{\pi}{2} \phi(0) = L_{\omega \rightarrow \infty} \int_0^{\beta} \frac{\sin \omega \xi}{\xi} \phi(\xi) d\xi.$$

$$\text{Therefore } L_{\omega \rightarrow \infty} \int_{\beta}^{\alpha} \frac{\sin \omega \xi}{\xi} \phi(\xi) d\xi = 0, \quad (\alpha > \beta > 0).$$

$$\text{Similarly } L_{\omega \rightarrow \infty} \int_{-\beta}^{-\alpha} \frac{\sin \omega \xi}{\xi} \phi(\xi) d\xi = 0.$$

$$\begin{aligned} \text{Again } L_{\omega \rightarrow \infty} \int_{\beta}^{-\alpha} \frac{\sin \omega \xi}{\xi} \phi(\xi) d\xi \\ = L_{\omega \rightarrow \infty} \left(\int_0^{-\alpha} - \int_0^{\beta} \right) \frac{\sin \omega \xi}{\xi} \phi(\xi) d\xi = -\frac{\pi}{2} \phi(0) - \frac{\pi}{2} \phi(0) = -\pi \phi(0), \end{aligned}$$

$$\begin{aligned} \text{and } L_{\omega \rightarrow \infty} \int_{-\beta}^{\alpha} \frac{\sin \omega \xi}{\xi} \phi(\xi) d\xi \\ = L_{\omega \rightarrow \infty} \left(\int_0^{\alpha} - \int_0^{-\beta} \right) \frac{\sin \omega \xi}{\xi} \phi(\xi) d\xi = \frac{\pi}{2} \phi(0) + \frac{\pi}{2} \phi(0) = \pi \phi(0). \end{aligned}$$

Hence when the limits are of the same sign, the result = 0. When of opposite sign, the result is $\pm \pi \phi(0)$, the sign being that of the upper limit. (Compare Art. 1625.)

$$\text{Again } \int_0^{\infty} \cos \xi u \, du = \left[\frac{\sin \xi u}{\xi} \right]_0^{\infty} = \frac{\sin \omega \xi}{\xi};$$

$$\therefore L_{\omega \rightarrow \infty} \int_0^h \phi(\xi) \left\{ \int_0^{\infty} \cos(\xi u) \, du \right\} d\xi = L_{\omega \rightarrow \infty} \int_0^h \frac{\sin \omega \xi}{\xi} \phi(\xi) d\xi,$$

$$\text{i.e. } \int_0^h \int_0^{\infty} \phi(\xi) \cos \xi u \, d\xi \, du = \pm \frac{\pi}{2} \phi(0), \text{ the sign being that of } h.$$

Further, $\int_{\beta}^{\alpha} \int_0^{\infty} \phi(\xi) \cos \xi u \, d\xi \, du$

$$= L_{\omega \rightarrow \infty} \int_{\beta}^{\alpha} \phi(\xi) \left\{ \int_0^{\infty} \cos(\xi u) \, du \right\} d\xi = L_{\omega \rightarrow \infty} \int_{\beta}^{\alpha} \frac{\sin \omega \xi}{\xi} \phi(\xi) \, d\xi$$

= 0, if α, β are of the same sign,

or = $\pm \pi \phi(0)$, according as α is positive or negative when β is of the opposite sign.

1631. Graphical Illustration.

Taking $\alpha > \beta > 0$ and $\xi - x = \eta$,

$$L_{\omega \rightarrow \infty} \int_{\beta}^{\alpha} \frac{\sin \omega(\xi - x)}{\xi - x} \phi(\xi) \, d\xi = L_{\omega \rightarrow \infty} \int_{\beta-x}^{\alpha-x} \frac{\sin \omega \eta}{\eta} \phi(x+\eta) \, d\eta$$

$$= 0 \left. \begin{array}{l} \text{if } x > \alpha > \beta \\ \text{or if } x = \alpha > \beta \end{array} \right\} \text{ or } = \frac{\pi}{2} \phi(\alpha) \left. \begin{array}{l} \text{if } x = \alpha > \beta \\ \text{or if } \alpha > x > \beta \end{array} \right\} \text{ or } = \pi \phi(x) \left. \begin{array}{l} \text{if } \alpha > x > \beta \\ \text{or if } \alpha > x = \beta \end{array} \right\} \text{ or } = \frac{\pi}{2} \phi(\beta) \left. \begin{array}{l} \text{if } \alpha > x = \beta \\ \text{or if } \alpha > \beta > x \end{array} \right\} = 0$$

The values of this integral may be shown graphically by the heavy lines and the two isolated points in Fig. 474, in which the dotted line is the graph of $y = \pi \phi(x)$.

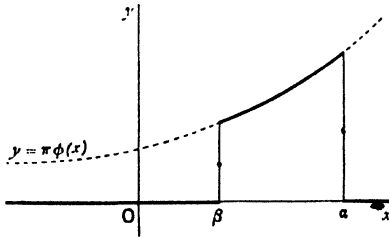

Fig. 474.

Obvious modifications will occur if α or β or both of them be negative or if $\alpha < \beta$.

1632. Still supposing that α and β are both positive and $\alpha > \beta$, and putting $\xi + x = \eta$, we have

$$L_{\omega \rightarrow \infty} \int_{\beta}^{\alpha} \frac{\sin \omega(\xi + x)}{\xi + x} \phi(\xi) \, d\xi = L_{\omega \rightarrow \infty} \int_{\beta+x}^{\alpha+x} \frac{\sin \omega \eta}{\eta} \phi(\eta - x) \, d\eta$$

$$= 0 \left. \begin{array}{l} \text{if } x > -\beta > -\alpha \\ \text{or if } x = -\beta > -\alpha \end{array} \right\} \text{ or } = \frac{\pi}{2} \phi(-x) = \frac{\pi}{2} \phi(\beta) \left. \begin{array}{l} \text{if } x = -\beta > -\alpha \\ \text{or if } -\beta > x > -\alpha \end{array} \right\} \text{ or } = \pi \phi(-x) \left. \begin{array}{l} \text{if } -\beta > x > -\alpha \\ \text{or if } -\beta > x = -\alpha \end{array} \right\}$$

$$\text{or } = \frac{\pi}{2} \phi(-x) = \frac{\pi}{2} \phi(\alpha) \left. \begin{array}{l} \text{if } -\beta > x = -\alpha \\ \text{or if } -\beta > -\alpha > x \end{array} \right\} = 0$$

And the graph of this integral is shown by the heavy lines and the two isolated points in Fig. 475, and is an image with regard to the y -axis of the graph of Fig. 474.

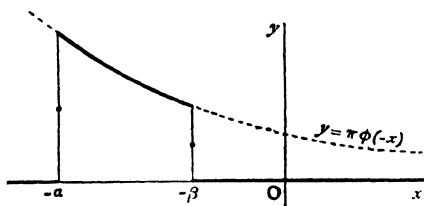

Fig. 475.

1633. Various Deductions.

$$\left. \begin{aligned} \text{Since } & \int_{\beta}^{\infty} \int_0^{\infty} \cos u(\xi-x) \phi(\xi) d\xi du \\ & = L_{\omega \rightarrow \infty} \int_{\beta}^{\infty} \frac{\sin \omega(\xi-x)}{\xi-x} \phi(\xi) d\xi \\ \text{and } & \int_{\beta}^{\infty} \int_0^{\infty} \cos u(\xi+x) \phi(\xi) d\xi du \\ & = L_{\omega \rightarrow \infty} \int_{\beta}^{\infty} \frac{\sin \omega(\xi+x)}{\xi+x} \phi(\xi) d\xi, \end{aligned} \right\} \begin{array}{l} \text{whose values} \\ \text{have been} \\ \text{found above,} \end{array}$$

we have by addition and subtraction, if x be positive,

$$\int_{\beta}^{\infty} \int_0^{\infty} \phi(\xi) \cos u\xi \cos ux d\xi du = \int_{\beta}^{\infty} \int_0^{\infty} \phi(\xi) \sin u\xi \sin ux d\xi du$$

$$\left. \begin{array}{l} = 0 \\ \text{if } x > a > \beta \end{array} \right\} \text{or } \left. \begin{array}{l} = \frac{\pi}{4} \phi(a) \\ \text{if } x = a > \beta \end{array} \right\} \text{or } \left. \begin{array}{l} \frac{\pi}{2} \phi(x) \\ \text{if } a > x > \beta \end{array} \right\}$$

$$\left. \begin{array}{l} \text{or } \frac{\pi}{4} \phi(\beta) \\ \text{if } a > x = \beta \end{array} \right\} \text{or } \left. \begin{array}{l} 0 \\ \text{if } a > \beta > x \end{array} \right\};$$

and if x be negative,

$$\int_{\beta}^{\infty} \int_0^{\infty} \phi(\xi) \cos u\xi \cos ux d\xi du = - \int_{\beta}^{\infty} \int_0^{\infty} \phi(\xi) \sin u\xi \sin ux d\xi du$$

$$\left. \begin{array}{l} = 0 \\ \text{if } x > -\beta > -a \end{array} \right\} \text{or } \left. \begin{array}{l} = \frac{\pi}{4} \phi(\beta) \\ \text{if } x = -\beta > -a \end{array} \right\} \text{or } \left. \begin{array}{l} = -\frac{\pi}{2} \phi(-x) \\ \text{if } -\beta > x > -a \end{array} \right\}$$

$$\left. \begin{array}{l} \text{or } \frac{\pi}{4} \phi(a) \\ \text{if } -\beta > x = -a \end{array} \right\} \text{or } \left. \begin{array}{l} = 0 \\ \text{if } -\beta > -a > x \end{array} \right\}.$$

1634. If $\beta=0$ and $a=\infty$ and x be > 0 ,

$$\int_0^{\infty} \int_0^{\infty} \phi(\xi) \cos u\xi \cos ux \, d\xi \, du = \int_0^{\infty} \int_0^{\infty} \phi(\xi) \sin u\xi \sin ux \, d\xi \, du \\ = \frac{\pi}{2} \phi(x); \quad \text{and if } x \text{ be } < 0,$$

$$\int_0^{\infty} \int_0^{\infty} \phi(\xi) \cos u\xi \cos ux \, d\xi \, du = - \int_0^{\infty} \int_0^{\infty} \phi(\xi) \sin u\xi \sin ux \, d\xi \, du \\ = \frac{\pi}{2} \phi(-x).$$

These results are all obvious on compounding the two graphs, Figs. 474 and 475.

When $x=0$ the second integral in each case vanishes.

1635. Since the products $\cos u\xi \cos ux$ and $\sin u\xi \sin ux$ are both even functions of u , they are not affected by a change of sign of u . Hence the integration of either of them with respect to u from $-\infty$ to ∞ yields double the result of that from 0 to ∞ ; therefore if x be positive,

$$\int_{\beta}^{\alpha} \int_{-\infty}^{\infty} \phi(\xi) \cos u\xi \cos ux \, d\xi \, du = \int_{\beta}^{\alpha} \int_{-\infty}^{\infty} \phi(\xi) \sin u\xi \sin ux \, d\xi \, du \\ = 0, \quad \frac{\pi}{2} \phi(\beta), \quad \pi \phi(x), \quad \frac{\pi}{2} \phi(\alpha) \text{ or } 0 \text{ in the several cases,}$$

and if x be negative,

$$\int_{\beta}^{\alpha} \int_{-\infty}^{\infty} \phi(\xi) \cos u\xi \cos ux \, d\xi \, du = - \int_{\beta}^{\alpha} \int_{-\infty}^{\infty} \phi(\xi) \sin u\xi \sin ux \, d\xi \, du \\ = 0, \quad \frac{\pi}{2} \phi(\beta), \quad \pi \phi(-x), \quad \frac{\pi}{2} \phi(\alpha) \text{ or } 0 \text{ in the corresponding cases.}$$

1636. If $\beta=0$ and $a=x$, we have

$$\int_0^x \int_{-\infty}^{\infty} \phi(\xi) \cos u\xi \cos ux \, d\xi \, du = \int_0^x \int_{-\infty}^{\infty} \phi(\xi) \sin u\xi \sin ux \, d\xi \, du \\ = \pi \phi(x), \quad (x + \text{ve}), \quad \dots \dots \dots (1)$$

$$\int_0^x \int_{-\infty}^{\infty} \phi(\xi) \cos u\xi \cos ux \, d\xi \, du = - \int_0^x \int_{-\infty}^{\infty} \phi(\xi) \sin u\xi \sin ux \, d\xi \, du \\ = \pi \phi(-x), \quad (x - \text{ve}). \quad \dots \dots \dots (2)$$

1637. **Fourier's Formula.**

Put $\xi = -\eta$, and write ψ for ϕ . Then, as x is $+ve$ or $-ve$,

$$\int_{-\infty}^0 \int_{-\infty}^{\infty} \psi(-\eta) \cos u\eta \cos ux \, d\eta \, du = \mp \int_{-\infty}^0 \int_{-\infty}^{\infty} \psi(-\eta) \sin u\eta \sin ux \, d\eta \, du \\ = \pi\psi(x) \text{ or } \pi\psi(-x), \text{ as } x \text{ is } +ve \text{ or } -ve.$$

Let $\psi(-\eta) = \phi(\eta)$, and write ξ for η . Then, as x is $+ve$ or $-ve$,

$$\int_{-\infty}^0 \int_{-\infty}^{\infty} \phi(\xi) \cos u\xi \cos ux \, d\xi \, du = \mp \int_{-\infty}^0 \int_{-\infty}^{\infty} \phi(\xi) \sin u\xi \sin ux \, d\xi \, du \\ = \pi\phi(-x) \text{ or } \pi\phi(x), \text{ as } x \text{ is } +ve \text{ or } -ve. \dots(3)$$

Hence from equations 1, 2 and 3, whether x be $+ve$ or $-ve$,

$$\left. \int_{-\infty}^{\infty} \int_{-\infty}^{\infty} \phi(\xi) \cos u\xi \cos ux \, d\xi \, du = \pi \{ \phi(x) + \phi(-x) \} \right\} \\ \text{and } \left. \int_{-\infty}^{\infty} \int_{-\infty}^{\infty} \phi(\xi) \sin u\xi \sin ux \, d\xi \, du = \pi \{ \phi(x) - \phi(-x) \} \right\}$$

By addition,

$$\int_{-\infty}^{\infty} \int_{-\infty}^{\infty} \phi(\xi) \cos u(\xi - x) \, d\xi \, du = 2\pi\phi(x),$$

which is Fourier's Formula.

1638. For $+ve$ values of x it follows that the graph of

$$y = \int_{-\infty}^{\infty} \int_{-\infty}^{\infty} \phi(\xi) \cos u(\xi - x) \, d\xi \, du$$

only differs from that of $y = \phi(x)$, in that all the ordinates of the latter are increased in the ratio $2\pi : 1$.

Similarly for $-ve$ values of x .

1639. **A Remarkable Application** (Bertrand, *Calc. Int.*, p. 238).

If in the formula $\int_0^{\infty} \int_0^{\infty} \phi(\xi) \cos u\xi \cos ux \, d\xi \, du = \frac{\pi}{2} \phi(x)$ or $\frac{\pi}{2} \phi(-x)$, as x is $+ve$ or $-ve$, we put $\phi(\xi) = e^{-a\xi}$, where a is $+ve$; and since

$$\int_0^{\infty} e^{-a\xi} \cos(u\xi) \, d\xi = \frac{a}{a^2 + u^2},$$

we have $\int_0^{\infty} \frac{\cos ux}{a^2 + u^2} \, du = \frac{\pi}{2a} e^{-ax}$ or $\frac{\pi}{2a} e^{ax}$, according as x is $+ve$ or $-ve$ (Art. 1048).

PROBLEMS.

1. Find in a series a function of period $4a$ which shall be equal to $a + x$ from $x = -2a$ to $x = 0$, and equal to $a - x$ from $x = 0$ to $x = 2a$.

[TRIN. COLL., 1891.]

2. Expand x^2 in a series of cosines of multiples of x between π and $-\pi$. What will the series so obtained represent for other values of x ?

3. Find a series of sines which shall be equal to kx from $x = 0$ to $x = l/2$, and equal to $k(l - x)$ from $x = l/2$ to $x = l$.

Find also a series of cosines to answer the same description.

[Ox. II. P., 1900.]

4. Expand $x(\pi - x)$ in a series of sines.

[Ox. II. P., 1900.]

5. Find a series of sines which shall represent nkx/l from $x = 0$ to $x = l/n$; k from $x = l/n$ to $x = (n - 1)l/n$; and $nk(l - x)/l$ from $x = (n - 1)l/n$ to $x = l$.

[COLLEGES, 1878.]

6. Trace the locus of the equation

$$\frac{y}{c} = \sum \frac{(-1)^n}{n^2} \sin \frac{n\pi a}{2c} \sin \frac{n\pi x}{2c}.$$

[ST. JOHN'S, 1884.]

7. A function of x is equal to x^2 for values of x between $x = 0$ and $x = l/2$, and vanishes when x is between $l/2$ and l ; express the function by a series of sines, and also by a series of cosines of multiples of $\pi x/l$. Draw figures showing the functions represented by the two series respectively for all values of x not restricted to lie between 0 and l . What are the sums of the series for the value $x = l/2$?

[γ, 1899.]

8. Show that

$$\log \operatorname{cosec} x = \log 2 + \cos 2x + \frac{1}{2} \cos 4x + \frac{1}{3} \cos 6x + \dots + \frac{1}{n} \cos 2nx + \dots,$$

($\theta < x < \pi$),

and deduce therefrom

$$(a) \int_0^{\frac{\pi}{2}} \log \sin x \, dx = \frac{\pi}{2} \log \frac{1}{2}; \quad (b) \int_0^{\frac{\pi}{2}} \cos 2nx \log \sin x \, dx = -\frac{\pi}{4n}.$$

9. Prove that

$$y^2 = \frac{2c^2}{3d} + \sum_1^{\infty} \frac{4d}{n^2\pi^2} \left\{ d \sin \frac{n\pi c}{d} - n\pi c \cos \frac{n\pi c}{d} \right\} \cos \frac{n\pi x}{d}$$

represents a series of circles of radius c with their centres on the x -axis at distances $2d$ apart, and also the portions of the axis exterior to the circles, one circle having its centre at the origin. [γ, 1893.]

10. Find a series of cosines of multiples of $\pi x/l$ which shall represent a function which is equal to $x^2/4a$ for values of x between 0 and $l/2$, and is equal to $(l-x)^2/4a$ when x is between $l/2$ and l .

What does the series represent for values of x not lying between 0 and l ? [COLLEGES, 1892.]

11. Find a Fourier series to be equal to x^3 between $x = \pm c$, and trace the locus

$$\frac{y}{c} = \frac{2}{\pi} \sum_{r=1}^{\infty} \frac{(-1)^{r-1}}{r} \left(1 - \frac{6}{\pi^2 r^2}\right) \sin \frac{\pi r x}{c}.$$

12. Show by evaluation of the integral that

$$\frac{2}{\pi} \int_0^{\infty} \sin qx \left\{ \frac{h}{q} + \tan a \frac{\sin qb - \sin qa}{q^2} \right\} dq$$

is the ordinate of a broken line running parallel to the axis of x from $x=0$ to $x=a$ and from $x=b$ to $x=\infty$, and inclined to the axis of x at an angle a between $x=a$ and $x=b$. [MATH. TRIP., 1883.]

13. If $f(x) = \sum A_n \sin n\pi x/l$ and $f'(x) = B_0 + \sum B_n \cos n\pi x/l$ for all values of x between 0 and l , prove that, provided $f(x)$ be continuous from $x=0$ to $x=l$,

$$B_n = \frac{n\pi}{l} A_n + \frac{2}{l} \{(-1)^n f(l) - f(0)\}.$$

Write down the corresponding formula if $f(x)$ be discontinuous for the value $x=a$ which lies between 0 and l . [COLLEGES, 1896.]

14. Prove that the locus represented by

$$\sum_{n=1}^{n=\infty} \frac{(-1)^{n-1}}{n^2} \sin nx \sin ny = 0$$

is two systems of lines at right angles dividing the coordinate plane into squares of area π^2 . [MATH. TRIP., 1895.]

15. Show that the equation

$$y = \frac{a}{2} + x - \frac{4a}{\pi^2} \left\{ \cos \frac{\pi}{a}(x+y) + \frac{1}{3^2} \cos \frac{3\pi}{a}(x+y) + \frac{1}{5^2} \cos \frac{5\pi}{a}(x+y) + \text{etc.} \right\}$$

represents a staircase formed of straight lines of length a , starting from the origin and parallel, alternately, to the axes of y and x .

[ST. JOHN'S COLL., 1881.]

16. If $f(\theta)$ be a finite function of θ with the period 2π , show how to find a function which, in the space between two concentric circles, is a finite and continuous solution of the equation $\frac{\partial^2 u}{\partial x^2} + \frac{\partial^2 u}{\partial y^2} = 0$, with

the value $f(\theta)$ at the point of the outer circle whose polar coordinate is θ , and the value zero at every point of the inner circle.

[MATH. TRIP., 1896.]

[After transformation to polars,

$$u = A_0 + \sum_1^{\infty} (A_n r^n + B_n r^{-n}) \cos n\theta + \sum_1^{\infty} (C_n r^n + D_n r^{-n}) \sin n\theta$$

may be taken as the solution of this equation.]

17. If y be defined as coincident with $y=x$ from $x=0$ to $x=\pi/2$; $y=\pi/2$ from $x=\pi/2$ to $x=3\pi/2$; $y=2\pi-x$ from $x=3\pi/2$ to $x=2\pi$, and be represented by a Fourier series of form $y=A_0 + \sum_1^{\infty} A_p \cos px$, show that

$$y = \frac{3\pi}{8} - \frac{2}{\pi} \sum_1^{\infty} \frac{\cos (2p-1)x}{(2p-1)^2} - \frac{1}{\pi} \sum_1^{\infty} \frac{\cos (4p-2)x}{(2p-1)^2},$$

and draw a graph of this series when x is not restricted to lie between 0 and 2π .

18. Prove that the series

$$\begin{aligned} \frac{1}{l} \int_0^l \frac{f(v) + f(-v)}{2} dv + \frac{2}{l} \sum_{n=1}^{\infty} \cos \frac{n\pi x}{l} \int_0^l \frac{f(v) + f(-v)}{2} \cos \frac{n\pi v}{l} dv \\ + \frac{2}{l} \sum_{n=1}^{\infty} \sin \frac{n\pi x}{l} \int_0^l \frac{f(v) - f(-v)}{2} \sin \frac{n\pi v}{l} dv \end{aligned}$$

is equal to $f(x)$ between the limits $x = +l$ and $x = -l$; and trace the curve represented by the series for values of x outside these limits.

[MATH. TRIP., 1885.]

19. Find by Fourier's method a function of x which shall be equal to $+1$ from $x=0$ to $x=a$, and equal to -1 from $x=a$ to $x=2a$, and so on alternately.

20. Two uniform plates of the same substance and thickness a are in contact. The outside surface of one is impervious to heat, and that of the other is kept at zero temperature. It can be shown that if one slips over the surface of the other with constant velocity v , the friction per unit of area being F , then at any time t the temperatures of the two plates are given by

$$\begin{aligned} \theta_1 = \frac{Fv}{JC} \left\{ a + \sum A_{2n+1} e^{-\frac{(2n+1)^2 \pi^2 C^2 t}{16a^2 v^2}} \cos (2n+1) \frac{\pi x}{4a} \right\}, \\ \theta_2 = \frac{Fv}{JC} \left\{ 2a - x + \sum A_{2n+1} e^{-\frac{(2n+1)^2 \pi^2 C^2 t}{16a^2 v^2}} \cos (2n+1) \frac{\pi x}{4a} \right\}, \end{aligned}$$

respectively, at a distance x from the impervious surface, where J , C , c are certain constants. Show that, if when $t=0$, θ is zero everywhere, the coefficients A_{2n+1} are given by

$$A_{2n+1} = - \left\{ \frac{4}{(2n+1)\pi} \right\}^2 a \cos(2n+1) \frac{\pi}{4}.$$

[MATH. TRIP. III., 1884.]

21. Deduce from the result $\int_0^\infty e^{-x^2} \cos 2bx \, dx = \frac{1}{2} \pi^{\frac{1}{2}} e^{-b^2}$, or otherwise obtain the result

$$\begin{aligned} & e^{-x^2} + e^{-(x-a)^2} + e^{-(x+a)^2} + e^{-(x-2a)^2} + e^{-(x+2a)^2} + \text{etc.} \\ &= \frac{\pi^{\frac{1}{2}}}{a} \left(1 + 2e^{-\frac{\pi^2}{a^2}} \cos \frac{2\pi x}{a} + 2e^{-\frac{4\pi^2}{a^2}} \cos \frac{4\pi x}{a} + 2e^{-\frac{9\pi^2}{a^2}} \cos \frac{6\pi x}{a} + \dots \right). \end{aligned}$$

[MATH. TRIP., 1887.]

22. Prove that the equation

$$\begin{aligned} \frac{\pi^2}{24} = & -\cos \frac{1}{2}(x+y) \cos \frac{1}{2}(x-y) + \frac{1}{2^2} \cos \frac{2}{2}(x+y) \cos \frac{2}{2}(x-y) \\ & - \frac{1}{3^2} \cos \frac{3}{2}(x+y) \cos \frac{3}{2}(x-y) + \dots \end{aligned}$$

represents a series of circles of radius π , and trace them.

[MATH. TRIP., 1885.]

23. Show that if all effects of atmosphere be neglected, then the intensity of daylight at a given place at t o'clock true solar time at an equinox will be

$$I \left[\frac{1}{\pi} + \frac{1}{2} \cos \frac{\pi t}{12} + \frac{2}{\pi} \left\{ \frac{1}{1.3} \cos \frac{\pi t}{6} - \frac{1}{3.5} \cos \frac{2\pi t}{6} + \frac{1}{5.7} \cos \frac{3\pi t}{6} - \dots \right\} \right],$$

where I is the intensity at noon. Examine the values of the above expression when (i) $t=0$, (ii) $t=6$, (iii) $t=12$. [MATH. TRIP., 1884.]

24. Prove that if

$$\sqrt{\pi} f(p) = \sqrt{2} \int_0^\infty \phi(x) \sin px \, dx,$$

then will $\sqrt{\pi} \phi(p) = \sqrt{2} \int_0^\infty f(x) \sin px \, dx$. [MATH. TRIP., 1884.]

25. Show that, if $Ei(x) \equiv \int_{-\infty}^x \frac{e^x}{x} dx$, then

$$\frac{1}{q} \int_0^\infty \{e^{qx} Ei(-qx) - e^{-qx} Ei(qx)\} \sin px \, dx$$

$$= \frac{1}{p} \int_0^\infty \{e^{qx} Ei(-qx) + e^{-qx} Ei(qx)\} \cos px \, dx = -\frac{\pi}{p^2 + q^2}.$$

[MATH. TRIP., 1884.]

26. Find two harmonic series, each of which shall be equal to bx/a from $x=0$ to $x=a$, one containing only harmonic functions of the form $\sin 2i\pi x/a$ and the other those of the form $\cos i\pi x/a$, where i is any integer. Trace the complete curve given by the harmonic series in each case. [MATH. TRIP., 1876.]

27. Sum the series $m \cos \theta - \frac{1}{3}m^3 \cos 3\theta + \frac{1}{5}m^5 \cos 5\theta - \dots$ *ad inf.*, m being < 1 , and prove that it always has the same sign as $m \cos \theta$. Trace the curve

$$r = a(\cos a \cos \theta - \frac{1}{3} \cos 3a \cos 3\theta + \frac{1}{5} \cos 5a \cos 5\theta - \dots).$$

[MATH. TRIP., 1878.]

28. Express the doubly infinite series

$$\sum_{m=1}^{m=\infty} \sum_{n=1}^{n=\infty} (-1)^{m+n} \frac{\cos mx \cos ny}{mn(m^2 + n^2)}$$

in the form of a singly infinite series of cosines of multiples of y .

[S. H. PROBLEMS, 1878.]

Exhibit the result in the form

$$\sum_{n=1}^{n=\infty} \left[\left\{ \phi(n) + \frac{1}{n^2} \log 2 \right\} \cosh nx - \frac{1}{n^2} \log 2 + \frac{1}{n} \int_0^x \sinh n(x-u) \log \cos \frac{u}{2} du \right] \frac{(-1)^n \cos ny}{n}.$$

29. Deduce Fourier's formula

$$2\phi(x) = \frac{1}{\pi} \int_{-\infty}^{\infty} \int_{-\infty}^{\infty} \phi(\xi) \cos u(\xi - x) d\xi du$$

from the formula

$$2\phi(x) = \frac{1}{l} \int_{-l}^l \phi(\xi) d\xi + \frac{2}{l} \sum_{p=1}^{p=\infty} \int_{-l}^l \phi(\xi) \cos \frac{p\pi}{l} (\xi - x) d\xi.$$

[POISSON. See TODHUNTER, I.C., Art. 332.]

30. Examine the limiting form of the curve

$$y = \frac{1}{\pi} \int_0^{\infty} e^{-kw} dw \left\{ \int_0^l \cos w(v-x) \cdot v dv \right\}$$

when k , being positive, tends to a zero limit.

[DE MORGAN, D.C., p. 629.]

31. Prove the two formulæ

$$f(x) = \frac{2}{\pi} \int_0^{\infty} \cos xu du \int_0^{\infty} f(t) \cos ut dt;$$

$$f(x) = \frac{2}{\pi} \int_0^{\infty} \sin xu du \int_0^{\infty} f(t) \sin ut dt,$$

and point out the distinction between the two expressions for $f(x)$.

[ST. JOHN'S COLL., 1881.]

32. Show that for all values of x between $-b$ and b ,

$$F(x) - F(-x) = \frac{2}{\pi} \int_0^{\infty} \sin xu \, du \int_{-b}^b F(y) \sin uy \, dy.$$

[ST. JOHN'S COLL., 1881.]

33. If a uniform horizontal bar, both of whose ends are fixed, be so displaced horizontally in the direction of its length that initially one half is uniformly extended and the other uniformly compressed, and then let go, prove that the displacement y of any particle x at any time t will be

$$\frac{8nl}{\pi^2} \sum \frac{1}{(2i+1)^2} \cos(2i+1) \frac{\pi at}{2l} \cos(2i+1) \frac{\pi x}{2l},$$

$2l$ being the length of the bar, the middle point being the origin and nl the displacement of the middle point.

[The equation determining these vibrations may be assumed to be $\frac{\partial^2 y}{\partial t^2} = a^2 \frac{\partial^2 y}{\partial x^2}$, and a suitable form of solution of this equation is $y = \sum C_m \cos mx \cos mat$.

Or more generally, for an equation of type $\frac{\partial^2 y}{\partial t^2} = a^2 \frac{\partial^2 y}{\partial x^2} + k$, y is of the form

$$A + Bx + Ct + Dx^2 + Ext + Ft^2 + \sum L \sin \{n(at - x) + \alpha\} \\ + \sum M \sin \{n(at + x) + \beta\}$$

with certain conditions. (See Forsyth, *D. Equations*) We are to have $y=0$ for all values of t when $x = \pm l$; and if $t=0$, $y = n(l-x)$ from $x=0$ to $x=l$, and $y = n(l+x)$ from $x = -l$ to $x=0$.]

34. A stream of uniform depth and of uniform width $2a$ flows slowly through a bridge consisting of two equal arches resting on a rectangular pier of width $2b$, the bridge being so broad that under it the water moves uniformly with velocity U . Show that after the stream has passed through the bridge the velocity potential of the motion is

$$\phi = \frac{a-b}{a} Ux + \frac{2aU}{\pi^2} \sum_1^{\infty} \frac{1}{i^2} \sin \frac{i\pi b}{a} \cos \frac{i\pi y}{a} e^{-\frac{i\pi x}{a}},$$

the axis of x being in the forward direction of the stream and the origin at the middle point of the pier. [MATH. TRIP., 1878.]

[The equation for ϕ is $\frac{\partial^2 \phi}{\partial x^2} + \frac{\partial^2 \phi}{\partial y^2} = 0$, and we are to have

$$\frac{\partial \phi}{\partial x} = \frac{a-b}{a} U \text{ when } x \text{ is infinite, } \frac{\partial \phi}{\partial x} = U \text{ when } x=0,$$

except from $y = -b$ to $y = b$, where $\frac{\partial\phi}{\partial x} = 0$; also $\frac{\partial\phi}{\partial y} = 0$ when $y = \pm a$, and a suitable solution of the equation is

$$\phi = A_0x + \sum_1^{\infty} A_i \cos \frac{i\pi y}{a} e^{-\frac{ix}{a}}.]$$

35. Show that $\frac{\pi}{4}z = \sum_0^{\infty} \frac{1}{(2p+1)^2} \sin(2p+1)x \sin(2p+1)y$ represents the four sloping faces of a regular pyramid built upon a horizontal square base of side π units, two sides coinciding with the axes of coordinates, the height of the pyramid being $\pi/2$ units.

[TODHUNTER, I.C., p. 304.]

36. A membrane is uniformly stretched upon a square frame to which it is attached along the edges. The centre is displaced slightly through a small distance k perpendicularly to the frame, the form being that of four planes passing through the edges of the square and a common point above the centre. The side of the square is a . The constraint is then removed. The equation to determine the subsequent vibrations is $\frac{\partial^2 w}{\partial t^2} = c^2 \left(\frac{\partial^2 w}{\partial x^2} + \frac{\partial^2 w}{\partial y^2} \right)$, and a solution suitable for such a case as the above may be assumed to be

$$w = \sum A_{n,r} \cos \gamma t \sin \frac{n\pi(x+a)}{2a} \sin \frac{r\pi(y+a)}{2a},$$

the origin being taken at the centre of the square and the axes parallel to its sides, t being the time measured from the instant of the removal of the constraint, and n and r being integers. Also it will be noted that $x = \pm a$ and $y = \pm a$ will each give $w = 0$ for all values of t .

Prove (i) $4a^2\gamma^2 = c^2\pi^2(n^2 + r^2)$, (ii) that n and r are odd,

(iii) $A_{n,r} = 0$ if $n \neq r$, (iv) $A_{n,n} = 8k/n^2\pi^2$,

and

$$w = \frac{8k}{\pi^2} \sum \frac{1}{(2i+1)^2} \sin \frac{(2i+1)\pi(x+a)}{2a} \sin \frac{(2i+1)\pi(y+a)}{2a} \cos(2i+1) \frac{c\pi t}{a\sqrt{2}}.$$

37. The fixed boundary of a membrane is a square, and the centre of the membrane is displaced perpendicularly through a small space k , the membrane being made to take the form of two portions of intersecting circular cylinders. Taking the same general form of solution as before of the equation for the vibrations when the constraints are suddenly destroyed, prove that n and r are *odd* integers, and that

$$A_{n,r} = \frac{128k}{\pi^4(n^2 - r^2)^2} \left(\frac{n^2 + r^2}{nr} - 2 \sin \frac{n\pi}{2} \sin \frac{r\pi}{2} \right);$$

$$A_{n,n} = \frac{8k}{n^2\pi^2} \left(1 + \frac{4}{n^2\pi^2} \right).$$

[MATH. TRIP. III., 1886.]

38. Ohm's Equation for the flux of electric current in a wire of section ω , conductivity k , and electrostatic capacity per unit length c , is $\frac{\partial V}{\partial t} = \frac{2k\omega}{c} \frac{\partial^2 V}{\partial x^2}$, giving the potential V in terms of t the time and x the distance of a point on the wire from a given origin on the wire.

Assuming as a solution of this equation $V = \frac{ax}{l} + \sum A_n e^{-\nu t} \sin(qx + B)$, where a is the constant potential for all values of t at the battery end of the wire and x is measured from the earth end, l being the length of the wire and A, B arbitrary constants, show that

$$V = \frac{ax}{l} + \sum A_n e^{-\frac{2k\omega}{c} \frac{n^2 \pi^2}{l^2} t} \sin \frac{n\pi x}{l};$$

and if when $t=0$, $V=0$ for all values of x from 0 to l , show that

$$V = \frac{ax}{l} + \frac{2a}{\pi} \sum \frac{\cos n\pi}{n} e^{-\frac{2k\omega}{c} \frac{n^2 \pi^2}{l^2} t} \sin \frac{n\pi x}{l}.$$

CHAPTER XXXVI.

MEAN VALUES.

1640. We next exhibit the application of the principles of the Integral Calculus to the calculation of mean values. This subject and that of Chances to be considered in the following chapter are wide, and the devices and artifices numerous. The general principles and theorems are however but few, and the problems arising depend for the most part directly upon the fundamental definitions. A considerable number of illustrative examples are appended to illustrate the more important modes of procedure in the application of the Calculus, and also in the evasion of the necessity in some cases for absolute integration. Many of these are fully worked out; others are left for the reader to complete the details of the integration when it is not necessary to supply them; for it is in the formation of the proper expressions to integrate and in the assignment of the correct limits that difficulties arise rather than in the subsequent mechanical process of evaluation.

1641. DEF. *The quantity $\frac{1}{n}(a_1+a_2+\dots+a_n)$ is defined as the Mean Value of the n quantities a_1, a_2, \dots, a_n , supposed all of the same kind, n being a finite number.*

This is the quantity known arithmetically as the "arithmetic mean" or average value. It may be written as $\frac{1}{n}\Sigma(a)$, and denoted by $M(a)$.

1642. Combination of Means of Several Groups.

If there be several groups of quantities of the same kind, viz. $(a_1, a_2, \dots, a_p), (b_1, b_2, \dots, b_q), (c_1, c_2, \dots, c_r), \dots$ of respective

numbers p, q, r , etc., and $M(a), M(b), M(c), \dots$ the respective means of the groups, then the mean M of the whole set is

$$M = \frac{\Sigma(a) + \Sigma(b) + \Sigma(c) + \dots}{p + q + r + \dots} = \frac{pM(a) + qM(b) + rM(c) + \dots}{p + q + r + \dots} = \frac{\Sigma pM(a)}{\Sigma p},$$

which is the same formula as that for the ordinate of the centroid of weights p, q, r, \dots placed at points whose ordinates are $M(a), M(b), M(c)$, etc.

1643. Mean Values of Products two and two, etc.

Let there be a group of n quantities of the same kind.

$$\text{Then} \quad \frac{(\Sigma a)^2}{n^2} = \frac{\Sigma a^2}{n^2} + \frac{2\Sigma a_r a_s}{n^2} = \frac{1}{n} \cdot \frac{\Sigma a^2}{n} + \frac{n-1}{n} \cdot \frac{\Sigma a_r a_s}{\frac{1}{2}n(n-1)}.$$

$$\text{Hence} \quad \{M(a)\}^2 = \frac{1}{n} M(a^2) + \frac{n-1}{n} M(a_r a_s).$$

Similarly

$$\frac{(\Sigma a)^3}{n^3} = \frac{\Sigma a^3}{n^3} + \frac{3\Sigma a_1^2 a_2}{n^3} + \frac{6\Sigma a_1 a_2 a_3}{n^3} = \frac{3}{n} \frac{\Sigma a^2 \Sigma a}{n} - \frac{2}{n^2} \frac{\Sigma a^3}{n} + \frac{(n-1)(n-2)}{n^2} \frac{\Sigma a_1 a_2 a_3}{\frac{1}{6}n(n-1)(n-2)},$$

$$\text{i.e.} \quad \{M(a)\}^3 = \frac{3}{n} M(a^2) M(a) - \frac{2}{n^2} M(a^3) + \frac{(n-1)(n-2)}{n^2} M(a_1 a_2 a_3).$$

We may note that when n is indefinitely large, the mean of the products of pairs is the square of the mean of all quantities; and the mean of the products three at a time is the cube of the mean of them all.

These rules determine the mean values of the products, two at a time and three at a time respectively in terms of the means of the original quantities, of their squares and of their cubes.

1644. Extension of the Conception of a Mean.

If the number of the quantities a_1, a_2 , etc., be very large, and their sum very large, the fraction $\frac{1}{n} \Sigma a$ tends to take the form ∞/∞ . In this case suppose the several quantities a_1, a_2 , etc., to be the equidistant ordinates of a continuous curve $y = \phi(x)$ corresponding to abscissae

$$x = a, \quad a+h, \quad a+2h, \quad \dots \quad a + (n-1)h = b, \quad \text{say.}$$

Then the mean is

$$\frac{1}{n} \{ \phi(a) + \phi(a+h) + \phi(a+2h) + \dots + \phi(a + \overline{n-1}h) \},$$

which may be written as $\sum_1^n h \phi\{a + (r-1)h\} / \Sigma h$, which when n is indefinitely increased takes the form

$$\int_a^b \phi(x) dx / (b-a).$$

It is assumed here that the several quantities $a_1, a_2, \dots a_n$ are such that no two consecutive ones differ by a finite difference when n is indefinitely great, but that the curve $y = \phi(x)$ is one in which there is a continuous change of the ordinates between the limits considered. Otherwise the integral expression would be meaningless.

1645. Geometrical Meaning of the "Mean Ordinate."

It follows that the value of the mean ordinate, taken for equidistant and indefinitely close ordinates, is represented by the area bounded by the curve, the x -axis and the terminal ordinates divided by the projection of the curve upon the x -axis.

That is the mean ordinate PN of a curve P_1Q_1 , between the initial and final ordinates N_1P_1, M_1Q_1 is such that the area $P_1N_1M_1Q_1PP_1$ is equal to that of the rectangle FN_1M_1G , where FG is drawn through P parallel to the x -axis (Fig. 476). So that as much of the area of this figure lies between PG and the curve as lies between PF and the curve.

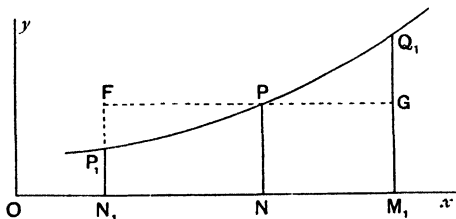

Fig 476.

1646. The Case when the Quantities are Functions of Several Variables. Nature of the Distribution.

If the quantities a_1, a_2, a_3, \dots be functions of several variables, first say of two, x and y , let us consider a_1, a_2, \dots to be the z -ordinates of a surface $z = \phi(x, y)$. Let the plane $x-y$ be imagined ruled by lines δx apart parallel to the y axis, and by lines δy apart parallel to the x -axis. Let one ordinate z , viz. $\phi(x, y)$, be erected at the corner x, y nearest the origin of the elementary rectangle $\delta x, \delta y$, and let the same be done at each of the corners nearest the origin of the remaining net-work of elementary rectangles. Then we shall understand by the "mean value" of z the limit of the fraction whose numerator is the sum of all these ordinates and whose

denominator is their number, or, what is the same thing, $\iint z \, dx \, dy \, \iint dx \, dy$, *i.e.* the volume bounded by the x - y plane, the surface $z = \phi(x, y)$, and cylindrical surface bounding the portion of the surface considered, whose generators are parallel to the z -axis, divided by the projection of that portion upon the x - y plane. It will be observed that the *number* of these ordinates is measured by $\iint dx \, dy$, that is the area of the projection described.

And if there be three independent variables, so that $u = \phi(x, y, z)$, we shall understand in the same way that by the "mean value" of u is meant $\iiint u \, dx \, dy \, dz / \iiint dx \, dy \, dz$, and the *number* of cases is measured by $\iiint dx \, dy \, dz$; and similarly if there be a greater number of independent variables. And as before it will be noted that it is assumed that no two contiguous quantities of the group considered differ by a finite difference when their number is infinitely great. That is to say, that unless some other distribution of the various quantities a_1, a_2, a_3 , etc., is expressly notified, the distribution in the case of two independent variables is that in which there is one ordinate to each of the elementary areas $\delta x \, \delta y$, which go to fill up the area on the x - y plane which may be bounded by the prescribed limits of the summation; and that for three independent variables the region through which the summation is to be effected is divided into equal volume elements $\delta x \, \delta y \, \delta z$, and that this summation is to be taken for one value of u , *viz.* $\phi(x, y, z)$, for each element of volume $\delta x \, \delta y \, \delta z$.

1647. Other Systems of Variables.

Of course the elements of area and of volume expressed in the Cartesian manner as $\delta x \, \delta y$, or as $\delta x \, \delta y \, \delta z$ respectively, may be replaced at will by the corresponding expressions $r \, \delta \theta \, \delta r$ or $r^2 \sin \theta \, \delta \theta \, \delta \phi \, \delta r$, if work in polar coordinates be indicated as more convenient for the problem under consideration, or by the corresponding elements for any other system of coordinates.

And if there be more independent variables than three, so that we fail to interpret the summation by geometry of two or of three dimensions, we shall still understand the mean of the function $u \equiv \phi(x_1, x_2, x_3, \dots x_n)$ to be

$$\frac{\iiint \dots \int u \, dx_1 \, dx_2 \dots dx_n}{\iiint \dots \int dx_1 \, dx_2 \dots dx_n},$$

and the number of cases to be measured by

$$\iiint \dots \int dx_1 \, dx_2 \dots dx_n$$

when the limits have been properly ascribed so as to effect the summations in the numerator and denominator for all values of the independent variables included in the compass of the summation to which the "mean value" refers.

1648. Nature of Various Distributions.

It will be manifest that in the case of a distribution of an infinite number of quantities such as the ordinates of a curve or of a surface, and whose mean is required, and which have so far been taken as equally distributed along the x -axis in the one case or over the x - y plane in the other, if this equable distribution ceases to hold good it will be necessary to form a clear conception of the nature of the distribution which is to be adopted. It will make this matter obvious if we take a simple example.

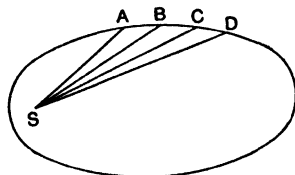

Fig. 477.

Consider the problem of finding the mean value of all focal radii vectores of an ellipse. Usually we should understand this to mean that if A, B, C, D, \dots be indefinitely close points on the circumference and S the focus from which the radii vectores are drawn, then the mean is to be taken for all the radii vectores such that the successive angles ASB, BSC, CSD, \dots are all equal infinitesimal angles $\delta\theta$. In which case, r being the radius vector for an angle θ , the mean value

$$= \frac{\int r \, d\theta}{\int d\theta}.$$

But it might be that the successive arcs AB, BC, CD, \dots are to be taken as equal, or that the successive areas are all equal,

or that the successive points A, B, C, D, \dots are defined by an equable distribution of the *feet of their ordinates* upon the x -axis, or other conceivable distributions may be adopted. The mean values in these cases are respectively

$$\int r \, ds / \int ds, \quad \int r \cdot r^2 \, d\theta / \int r^2 \, d\theta, \quad \int r \, dx / \int dx,$$

and the several results are obviously not the same.

1649. “Density” of a Distribution. General Remarks.

It will appear therefore that in each case the nature of the distribution, or, as it may be called, the “Density,” must be carefully defined. This is of primary importance.

When the distribution is one in which the angles between the successive radii vectores are equal infinitesimal angles, as in the case cited, they may be described as equally distributed about the origin from which they are drawn. This is the usual case.

In the same way, in three dimensions, when a distribution of radii vectores drawn from an origin to a surface is said to be “equable,” we shall understand this to mean that a unit sphere having been drawn with centre at the origin, and its surface having been divided into equal elementary areas, one, or the same number of radii vectores, passes through each of these elementary areas. The mean value of r will then be $\iint r \cdot \sin \theta \, d\theta \, d\phi / \iint \sin \theta \, d\theta \, d\phi$ or $\int r \, d\omega / \int d\omega$, where $\delta\omega$ is the elementary solid angle subtended at the origin by each element of the surface.

If the surface itself be divided into equal elementary areas δS , and the same number of radii vectores pass through each such element, the distribution may be called an “equable surface distribution,” and the mean value will be $\int r \, dS / \int dS$.

If radii vectores be drawn from the origin to points within the region bounded by a given surface, it is usually understood that they are drawn to equal elements of volume. The mean is then

$$\iiint r \cdot r^2 \sin \theta \, d\theta \, d\phi \, dr / \iiint r^2 \sin \theta \, d\theta \, d\phi \, dr.$$

1650. ILLUSTRATIVE EXAMPLES.

1. Find the mean distance of points on the circumference of the ellipse from a focus, the density of the distribution being defined as one in which successive pairs of points subtend equal angles at the focus.

Taking the equation as $lr^{-1} = 1 + e \cos \theta$, we have, b being the semi-minor axis,

$$M(r) = \frac{\int r d\theta}{\int d\theta} = \frac{2l \int_0^\pi (1 + e \cos \theta)^{-1} d\theta}{2\pi} = \frac{l}{\pi} \frac{2}{\sqrt{1-e^2}} \left[\tan^{-1} \left(\sqrt{\frac{1-e}{1+e}} \tan \frac{\theta}{2} \right) \right]_0^\pi = \frac{2b}{\pi} \cdot \frac{\pi}{2} = b.$$

2. Find the mean inverse distance of points within an ellipse from the focus, the distribution being an equable areal one.

Here $M\left(\frac{1}{r}\right) = \frac{\int \int \frac{1}{r} \cdot r d\theta dr}{\int \int r d\theta dr} = \frac{\int \int d\theta dr}{\text{Area}} = \frac{\int r d\theta}{\text{Area}} = \frac{2\pi b}{\pi ab} = \frac{2}{a};$

a, b being the semi-axes.

3. Find the mean distance of a point within an ellipse from a focus.

[COLLEGES a, 1886 and 1879.]

Here $M(r) = \frac{\int \int r \cdot r d\theta dr}{\int \int r d\theta dr} = \frac{2}{3\pi ab} \int_0^\pi r^3 d\theta = \frac{2l^3}{3\pi ab} \int_0^\pi \frac{d\theta}{(1 + e \cos \theta)^3}$
 $= \frac{2l^3}{3\pi ab} \frac{1}{(1 - e^2)^{\frac{3}{2}}} \int_0^\pi (1 - e \cos u)^2 du$ (Art. 196)
 $= \frac{2l^3}{3\pi ab} \frac{1}{(1 - e^2)^{\frac{3}{2}}} \left(\pi + 2e^2 \frac{1}{2} \pi \right) = \frac{l^3}{3a^2} \frac{2 + e^2}{(1 - e^2)^{\frac{3}{2}}} = a - \frac{l}{3}.$

4. Find the mean distance of points within an ellipse from the centre.

[COLLEGES a, 1886.]

Here, measuring θ from the minor axis,

$$r^2 = \frac{a^2 \sin^2 \theta}{a^2} + \frac{b^2 \cos^2 \theta}{b^2} \text{ and } M(r) = \frac{4}{3\pi ab} \int_0^{\frac{\pi}{2}} r^3 d\theta = \frac{4a^2 b^2}{3\pi} \int_0^{\frac{\pi}{2}} \frac{d\theta}{(a^2 \cos^2 \theta + b^2 \sin^2 \theta)^{\frac{3}{2}}}$$

$$= \frac{4b^2}{3\pi a} \int_0^{\frac{\pi}{2}} \frac{d\theta}{(1 - e^2 \sin^2 \theta)^{\frac{3}{2}}} = \frac{4b^2}{3\pi a} \cdot \frac{1}{1 - e^2} \int_0^{\frac{\pi}{2}} (1 - e^2 \sin^2 \theta)^{\frac{1}{2}} d\theta$$
 (Art. 391 (1))
 $= \frac{1}{3\pi} \times (\text{Perimeter of Ellipse})$ (Art. 567).

5. Find the mean of the distances from one of the foci of a prolate spheroid to points within the surface.

[WOLSTENHOLME, *Educ. Times.*]

Taking $lr^{-1} = 1 + e \cos \theta$ as the generating ellipse,

$$M(r) = \frac{\iiint r \cdot r^2 \sin \theta d\theta d\phi dr}{\text{Volume}} = \frac{2\pi}{\text{Vol.}} \frac{l^4}{4} \int_0^\pi \frac{\sin \theta}{(1 + e \cos \theta)^4} d\theta = \text{etc.} = \frac{a}{4} (3 + e^2).$$

6. A particle describes an ellipse about a centre of force in the focus S . Show that its mean distance from S with regard to time is $a\left(1 + \frac{e^2}{2}\right)$. [R.P.]

If t be the time, then $r^2 \frac{d\theta}{dt} = \text{const.} = h$, for equal sectorial areas are described in equal times.

$$\text{Hence } M(r) = \frac{\int r dt}{\int dt} = \frac{\int r^3 d\theta}{\int r^2 d\theta} = \frac{\int_0^\pi r^3 d\theta}{\text{Area}} = a\left(1 + \frac{e^2}{2}\right) \text{ (by Ex. 3).}$$

7. Find the mean value of r^{-2} with regard to time under the same circumstances.

$$M(r^{-2}) = \frac{\int \frac{1}{r^2} dt}{\int dt} = \frac{\int d\theta}{\int r^2 d\theta} = \frac{2\pi}{2 \cdot \text{Area}} = \frac{1}{ab}.$$

8. Show that the mean distance of points within a square from one of the angular points is to a side of the square in the ratio $\{\sqrt{2} + \log(\sqrt{2} + 1)\}$ to 3.

Take OA, OC , sides of the square $OABC$, as coordinate axes. We may confine our attention to points within the triangle OAB without altering the result. Let a be a side of the square. $OP = r$. Then (Fig. 478)

$$M(r) = \frac{\int_0^\pi \int_0^{a \sec \theta} r^2 d\theta dr}{\frac{1}{2}a^2} = \frac{2}{3}a \int_0^\pi \sec^3 \theta d\theta = \frac{a}{3} \{\sqrt{2} + \log(\sqrt{2} + 1)\}.$$

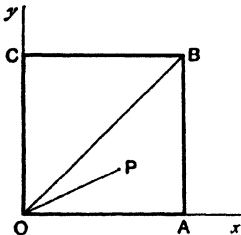

Fig. 478.

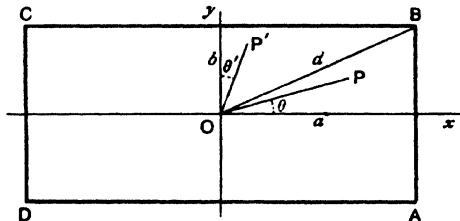

Fig. 479.

9. Find the mean distance of a point within a rectangle from the centre.

[Ox. II. P., 1885.]

Taking $2a, 2b, 2d$ as the sides and diagonal, and axes parallel to the sides through the centre (Fig. 479),

$$\begin{aligned} M(r) &= \frac{\iint r \cdot r d\theta dr}{\iint r d\theta dr} = \frac{4}{3 \cdot \text{Area}} \left\{ \int_0^{\tan^{-1} \frac{b}{a}} a^3 \sec^3 \theta d\theta + \int_0^{\tan^{-1} \frac{a}{b}} b^3 \sec^3 \theta' d\theta' \right\} \\ &= \frac{1}{6} \frac{a^2}{b} \left\{ \frac{d}{a} \cdot \frac{b}{a} + \log \frac{d+b}{a} \right\} + \frac{1}{6} \frac{b^2}{a} \left\{ \frac{d}{b} \cdot \frac{a}{b} + \log \frac{d+a}{b} \right\} \\ &= \frac{d}{3} + \frac{a^2}{6b} \log \frac{d+b}{a} + \frac{b^2}{6a} \log \frac{d+a}{b}. \end{aligned}$$

This is also obviously the result for the mean distance of a point within a rectangle of sides a, b and diagonal d from one of the angular points.

10. Find the mean distance of points on a spherical surface from a fixed point O on the surface for an equable surface distribution of radii vectores.

Here $M(r) = \int r dS / \int dS$, where dS is an element of the surface, and with the notation indicated in Fig. 480,

$$M(r) = \int_0^{\frac{\pi}{2}} \int_0^{2\pi} 2a \cos \theta \cdot 2a d\theta \cdot a \sin 2\theta d\phi / 4\pi a^2 = 16\pi a^3 / 12\pi a^2 = 4a/3.$$

11. Find the same mean for a distribution of radii vectores equably drawn in all directions from O .

Here
$$M(r) = \frac{\int r d\omega}{\int d\omega} = \frac{1}{2\pi} \int_0^{\frac{\pi}{2}} \int_0^{2\pi} 2a \cos \theta \cdot \sin \theta d\theta d\phi = a.$$

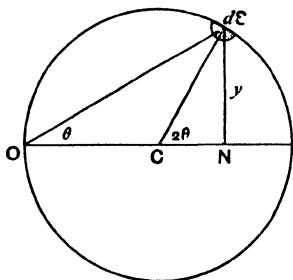

Fig. 480.

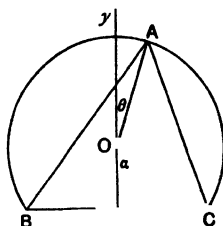

Fig. 481.

12. Triangles are drawn on a given base a , and with a given vertical angle α . Find the average area. [SANJANA, Educ. Times.]

Let A be the vertex, BC the base $= a$, O the circumcentre, $OA = R$, making an angle θ with a perpendicular to the base. Then $R = a/2 \sin \alpha$.

The perpendicular from A upon $BC = R(\cos \theta + \cos \alpha)$, and if the mean be for an equable distribution of positions of OA , (Fig. 481),

$$M(\triangle ABC) = \frac{1}{2} a R \int_0^{\pi - \alpha} (\cos \theta + \cos \alpha) d\theta / \int_0^{\pi - \alpha} d\theta$$

$$= \frac{1}{2} \frac{aR}{\pi - \alpha} \left[\sin \theta + \theta \cos \alpha \right]_0^{\pi - \alpha} = \frac{a^2}{4} \left(\frac{1}{\tan \alpha} + \frac{1}{\pi - \alpha} \right).$$

13. (a) A person is left a triangular piece of ground whose perimeter only is known; show that he may fairly calculate that the area is to that of a circle whose radius is the known perimeter as 1 : 105, sides of all possible lengths being equally likely to occur. [MATH. TRIPOS.]

(b) A straight line of length a is broken into three parts at random. If the three parts can be formed into a triangle, find its mean area.

[ST. JOHN'S COLL., 1881.]

(a) and (b) are the same problem.

Let OA be the line, P, Q the random points of division, P being the nearer to O , $OP=x$, $OQ=y$, $OA=a$. Then

$$\Delta = \sqrt{\frac{a}{2}\left(\frac{a}{2}-x\right)\left(\frac{a}{2}-y+x\right)\left(y-\frac{a}{2}\right)}, \quad \text{and} \quad M(\Delta) = \iint \Delta \, dx \, dy / \iint dx \, dy.$$

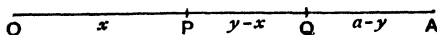

Fig. 482.

The limits of integration are to be such that

(i) $x + (y - x) < (a - y)$; (ii) $(y - x) + (a - y) < x$; (iii) $(a - y) + x < (y - x)$,
 i.e. $y < \frac{a}{2}$, $x > \frac{a}{2}$, and $y > \frac{a}{2} + x$. So the limits are, for x , $y - \frac{a}{2}$ to $\frac{a}{2}$;
 for y , $\frac{a}{2}$ to a . Now putting $\frac{a}{2} - x = u$, $a - y = b$,

$$\int_{y=\frac{a}{2}}^{\frac{a}{2}} \sqrt{\left(\frac{a}{2}-x\right)\left(\frac{a}{2}-y+x\right)} \, dx = \int_0^b \sqrt{u(b-u)} \, du = \frac{\pi b^2}{8} = \frac{\pi}{8} (a-y)^2.$$

Therefore writing $y = \frac{a}{2} + z$,

$$\iint \Delta \, dx \, dy = \frac{\pi}{8} \sqrt{\frac{a}{2}} \int_0^{\frac{a}{2}} \left(z - \frac{a}{2}\right)^2 \sqrt{z} \, dz = \frac{\pi a^4}{8 \times 105}.$$

Also
$$\iint dx \, dy = \int_{\frac{a}{2}}^a (a-y) \, dy = \frac{a^2}{8};$$

$\therefore M(\Delta) = \frac{\pi a^2}{105} = \frac{1}{105}$ of the area of a circle whose radius is a .

1651. The Mean Inverse Distance considered as a Potential Function.

In problems on the mean value of the inverse distance between pairs of points, much labour of integration may often be avoided if it be recognised that such problems are in fact problems on the mutual potential of two gravitating systems of material particles.

The potential at any point P of a system of gravitating particles of masses m_1, m_2, m_3 , etc., at distances r_1, r_2, r_3 , etc., from P is defined as $\Sigma m/r$.

The Mutual Potential of two gravitating systems of masses of two separate groups $(m_1, m_1', m_1'', \dots)$ and $(m_2, m_2', m_2'', \dots)$

is defined as $\Sigma m_1 m_2 / r_{12}$, where r_{12} represents the distance between m_1 and m_2 , etc.

But if the particles be *particles of the same group*, the mutual potential is $\frac{1}{2} \Sigma m_1 m_2 / r_{12}$. [See Routh, *Attractions*, p. 29.]

1652. **Theorems in Potential required for the Problems to be considered.**

In the case of a spherical shell of mass M , the potential at an external point at a distance r from the centre is M/r . But at an internal point it is M/a , where a is the radius.

In the case of a solid sphere, the potential at an external point at a distance r from the centre is again M/r ; at an internal point $\frac{2\pi\rho}{3}(3a^2 - r^2)$, M being in each case the mass and ρ the uniform volume density.

The potential of a thin rod AB at any point P is

$$m \log \cot \frac{1}{2} P \hat{A} B \cot \frac{1}{2} P \hat{B} A,$$

m being the mass per unit length = mass/length.

These integrals are all well known, and are useful in the present class of problem. Many other cases will be found in Routh's *Attractions*.

1653. *Suppose we are to find the mean of the inverse distance between two points P and Q , of which P lies on a spherical surface of centre C and radius a , and Q lies in any other region R which lies entirely without the shell.*

Let dS be an element of the spherical surface, dR an element of volume of the region R .

Then

$$M \left(\frac{1}{PQ} \right) = \frac{\iint \frac{1}{PQ} dS dR}{\iint dS dR}.$$

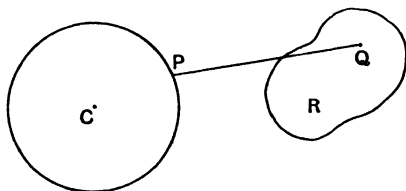

Fig. 483.

Suppose the surface and volume densities to be unity, and let $PQ = \rho$. Then

$$\begin{aligned} M \left(\frac{1}{PQ} \right) &= \frac{1}{S \cdot R} \int (\text{potential of shell at } Q) dR \\ &= \frac{1}{S \cdot R} \int S \cdot \frac{dR}{CQ} = \frac{1}{R} \cdot \text{potential of } R \text{ at } C. \end{aligned}$$

If any portion of R lies within the shell, let R_i and R_o be the masses of the portions lying respectively within and without the shell; Q and Q' two points of the region R , the one outside, the other inside the shell. Then

$$\begin{aligned} \iint \frac{dS \cdot dR}{PQ} &= \iint \frac{dS \cdot dR_o}{PQ} + \iint \frac{dS \cdot dR_i}{PQ'} \\ &= S \cdot \text{potential of } R_o \text{ at } C + S \cdot \frac{R_i}{a}. \end{aligned}$$

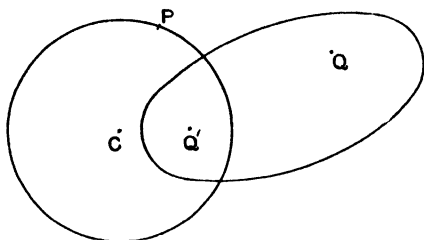

Fig. 484.

Hence $M\left(\frac{1}{\rho}\right) = \frac{1}{R} \left\{ \text{potential of } R_o \text{ at } C + \frac{R_i}{a} \right\}$.

(See a Theorem due to Gauss; Routh, *Attractions*, Art. 70.)

If R lies entirely inside S , $R_o = 0$, $R_i = R$ and $M\left(\frac{1}{\rho}\right) = \frac{1}{a}$.

1654. EXAMPLES.

1. Find the mean inverse distance between a point P which lies on a spherical surface of radius a , and a point Q which lies on a circular disc of radius b , whose plane passes through the centre of the sphere, and the disc lying (i) entirely without the spherical surface, (ii) entirely within.

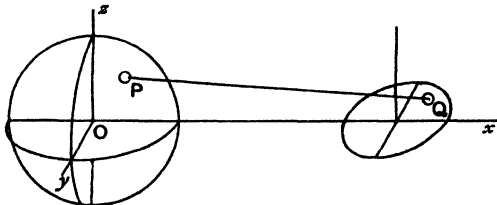

Fig. 485.

(i) Let O be the centre of the sphere, ρ the distance between a pair of the points. Then we have

$$M\left(\frac{1}{\rho}\right) = \frac{1}{\pi b^2} \cdot \text{potential of disc at } O.$$

If $c \equiv$ the distance between the centres, this may be expressed as

$$\frac{1}{\pi b^2} \int_0^{2\pi} \frac{b(b - c \cos \theta) d\theta}{\sqrt{b^2 - 2bc \cos \theta + c^2}}, \quad [\text{MATH. TRIP., 1884.}]$$

or as
$$\frac{4c}{\pi b^2} [E_1 - k'^2 F_1], \quad k = \frac{b}{c}.$$

(ii) If the disc lie entirely within the spherical shell, we have at once

$$M\left(\frac{1}{\rho}\right) = \frac{1}{a}.$$

2. Find the mean inverse distance of two points P and Q , one within a sphere of centre A and radius a , the other within a sphere of centre B and radius b , the centres being at a distance c apart ($c > a + b$).

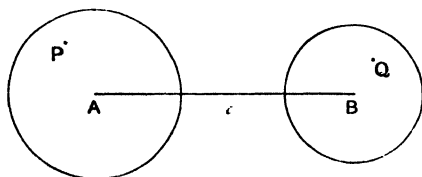

Fig. 486.

If V, V' be the respective volumes, $PQ = \rho$,

$$\begin{aligned} M\left(\frac{1}{\rho}\right) &= \frac{\iint \frac{dV dV'}{PQ}}{VV'} = \frac{\int (\text{potential of } V \text{ at } Q) dV'}{VV'} = \frac{\int \frac{V}{AQ} dV'}{VV'} \\ &= \frac{1}{V'} \int \frac{dV'}{AQ} = \frac{1}{V'} \cdot \text{potential of } V' \text{ at } A = \frac{1}{V'} \cdot \frac{V'}{AB} = \frac{1}{c}. \end{aligned}$$

1655. A Useful Artifice:

Let M_1 represent the mean value of any function of the distance between two points, one fixed on the boundary of any region, the other free to traverse the region. Let M_2 be the mean of the same function when each point may traverse the region. Then either of these quantities may be deduced from the other.

Let A be the area, or V the volume of the region, according as it be of two or of three dimensions.

Let R stand for A or V as the case may be. Construct a parallel curve or surface by taking a length dn (a constant) upon each outward drawn normal, thus making an annulus or shell round the original region. (Fig. 487.)

By this increase of the region R , M_2 is increased by the cases in which one or other of the points lies in this shell, or by both lying in the shell.

The *number* of cases to be examined in finding M_2 is measured by R^2 .

The *sum* of the cases is measured by $M_2 R^2$.

The increase in this sum due to the increase of the normals from n to $n + dn$ is $\frac{d}{dn}(M_2 R^2) dn$.

Again, the *number* of cases added by taking *one end* of the line on the shell and the other free to traverse the region it encloses, is measured by $R \cdot S dn$, where S is the perimeter (or the surface, as the case may be) of the region. The same is true if the second end lies in the shell and the first is free to traverse the bounded region, whilst if *both ends* lie on the shell the number of added cases is measured by $(S dn)^2$.

Hence $\frac{d}{dn}(M_2 R^2) dn = 2M_1 \cdot R \cdot S dn + M_1 (S dn)^2$;

and as the second term on the right is a second-order infinitesimal, we have in the limit when dn is indefinitely small, $\frac{d}{dn}(M_2 R^2) = 2M_1 R S$, by which equation the value of either M_1 or M_2 can be deduced when the other has been found. This artifice is useful for circular areas or spherical regions, and may be used in other cases.

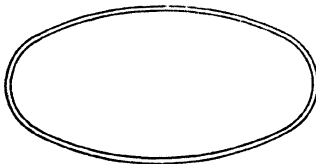

Fig. 487.

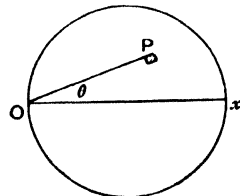

Fig. 488.

1656. ILLUSTRATIVE EXAMPLES.

1. (i) Show that the mean distance of points within a circle from a fixed point in the circumference, viz. M_1 , is $32a/9\pi$, a being the radius.

(ii) Show that the mean distance between any two points within the circle, viz. M_2 , is $128a/45\pi$. [ST. JOHN'S COLL., 1885.]

Let O be the fixed point on the circumference and Ox the diameter through O . r, θ the coordinates of any point P . (Fig. 488.)

$$(i) \quad M_1 = M(OP) = \frac{\iint r^2 d\theta dr}{\iint r d\theta dr} = \frac{\frac{2}{3} \int_0^{\frac{\pi}{2}} (2a \cos \theta)^3 d\theta}{\int_0^{\frac{\pi}{2}} (2a \cos \theta)^2 d\theta} = \frac{2}{3} \cdot 2a \frac{\frac{2}{3}}{\frac{1}{2} \cdot \frac{\pi}{2}} = \frac{32a}{9\pi}.$$

(ii) Again $d\{(\pi a^2)^2 M_2\} = 2 \cdot \pi a^2 \cdot 2\pi a da \cdot \frac{32a}{9\pi} = \frac{128}{9} \pi a^4 da,$

and M_2 vanishes with a .

$$\therefore \pi^2 a^4 M_2 = \frac{128}{45} \pi a^5 \quad \text{and} \quad M_2 = \frac{128a}{45\pi}.$$

2. (i) Find M_1 , the mean distance of a point on the surface of a sphere of radius a from internal points.

(ii) Find M_2 , the mean distance between two points within a sphere of radius a .

$$(i) M_1 = \frac{\iiint r \cdot r^2 \sin \theta d\theta d\phi dr}{\iiint r^2 \sin \theta d\theta d\phi dr} = \frac{3}{4\pi a^3} \cdot \frac{1}{4} \cdot 2\pi \cdot (2a)^4 \int_0^{\frac{\pi}{2}} \cos^4 \theta \sin \theta d\theta = \frac{6a}{5}.$$

$$(ii) d\{(\frac{4}{3}\pi a^3)^2 M_2\} = 2 \cdot \frac{4}{3}\pi a^3 \cdot 4\pi a^2 da \cdot \frac{6a}{5},$$

and M_2 vanishes with a ;

$$\therefore (\frac{4}{3}\pi a^3)^2 M_2 = \frac{8}{15}\pi^2 a^7 \quad \text{and} \quad M_2 = \frac{8}{15}\frac{a}{\pi}.$$

3. Mean distance of points within a sphere of radius a and centre C from a given external point O ; $OC = c$.

Let OQQ' be a chord through an internal point P , whose coordinates are r, θ with reference to O as origin, and let ϕ be the azimuthal angle of the plane OCP . Then

$$M(r) = \frac{3}{4\pi a^3} \iiint r^3 \sin \theta d\theta d\phi dr = \frac{3}{4\pi a^3} \cdot \frac{2\pi}{4} \int_0^{\sin^{-1}a/c} (OQ'^4 - OQ^4) \sin \theta d\theta.$$

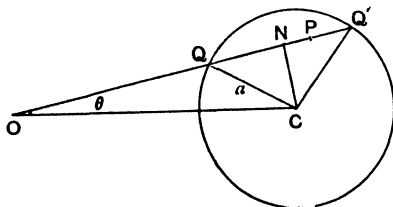

Fig. 489.

Let $OQ' = 2z$; then

$$z^2 = a^2 - c^2 \sin^2 \theta, \quad z dz = -c^2 \sin \theta \cos \theta d\theta = -\frac{1}{2} (OQ + OQ') c \sin \theta d\theta,$$

and the limits for z are from a to 0 .

$$\therefore M(r) = \frac{3}{8a^3} \int_0^a 2z(4z^2 + 2(c^2 - a^2)) \frac{2z dz}{c} = \frac{3}{a^2 c} \left[\frac{2}{5} z^5 + (c^2 - a^2) \frac{z^3}{3} \right]_0^a = c + \frac{1}{5} \frac{a^2}{c}.$$

4. Mean distance of points upon the surface of the sphere from a point O without the sphere.

The number of cases in which P can traverse the whole sphere is measured by $\frac{4}{3}\pi \nu^3$. Therefore the sum of such cases is $\frac{4}{3}\pi a^3 \left[c + \frac{1}{5} \frac{a^2}{c} \right]$.

The change effected in this by increasing a to $a+da$ is

$$\frac{d}{da} \frac{4}{3} \pi a^3 \left(c + \frac{1}{5} \frac{a^2}{c} \right) da = 4\pi a^2 \left(c + \frac{1}{3} \frac{a^2}{c} \right) da.$$

The number of these introduced cases is to the first order $4\pi a^2 da$, the new cases being those of the points on the shell. Hence the mean required $= c + \frac{1}{3} \frac{a^2}{c}$.

5. Find the mean distance of all points P within a sphere of radius a and centre C from a fixed internal point O ; $OC = c$.

$$\text{Here } M(OP) = \frac{1}{\text{vol.}} \iiint r^2 \sin \theta \, d\theta \, d\phi \, dr = \frac{3}{4\pi a^3} \cdot \frac{2\pi}{4} \int [r^4] \sin \theta \, d\theta.$$

Let QQ' be the chord through P , AOA' a diameter and BOB' the perpendicular chord. Let $A\hat{O}Q = \theta$, $A'\hat{O}Q' = \theta'$. We may replace $[r^4] \sin \theta$ by $OQ^4 \sin \theta + OQ'^4 \sin \theta'$ and integrate with regard to θ ($= \theta'$) from 0 to $\frac{\pi}{2}$; for having integrated for ϕ from 0 to 2π , all elements will be thus summed. Now $OQ^2 + OQ'^2 = 2(a^2 + c^2) - 4c^2 \sin^2 \theta$, and

$$OQ^4 + OQ'^4 = \{4(a^2 + c^2)^2 - 2(a^2 - c^2)^2\} - 16c^2(a^2 + c^2) \sin^2 \theta + 16c^4 \sin^4 \theta.$$

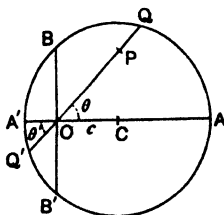

Fig. 490.

Hence

$$M(OP) = \frac{3}{8a^3} \left\{ (2a^4 + 12a^2c^2 + 2c^4) - \frac{32}{3} c^2(a^2 + c^2) + 16c^4 \cdot \frac{4 \cdot 2}{5 \cdot 3} \right\} = \frac{3}{4} a + \frac{1}{2} \frac{c^3}{a} - \frac{1}{20} \frac{c^4}{a^2}.$$

When $c = a$ this becomes $6a/5$.

6. Deduce from the last result the mean distance between two random points within a sphere.

Taking C for pole and r_1, θ_1, ϕ_1 as the coordinates of O , the sum of the cases with a given point O for an extremity is

$$\frac{4}{3} \pi a^3 \left[\frac{3a}{4} + \frac{1}{2} \frac{r_1^3}{a} - \frac{1}{20} \frac{r_1^4}{a^2} \right].$$

Multiplying by $r_1^2 \sin \theta_1 \, d\theta_1 \, d\phi_1 \, dr_1$ and integrating through the sphere, we have

$$\text{Mean value required} = \frac{1}{\left(\frac{4}{3}\pi a^3\right)^2} \cdot \frac{4}{3} \pi a^3 \cdot 2\pi \cdot 2 \cdot \left[\frac{3a}{4} \cdot \frac{a^3}{3} + \frac{1}{2a} \cdot \frac{a^5}{5} - \frac{1}{20a^2} \cdot \frac{a^7}{7} \right] = \frac{36a}{35}$$

or otherwise in Ex. 2.

7. Find the mean distance of a given point O within a sphere from points on the surface.

The sum of the cases of distances of internal points from O being as in the last example, $\pi(a^4 + \frac{2}{3}c^2a^2 - \frac{1}{3}c^4)$ is increased by $\pi(4a^3 + \frac{4}{3}c^2a)da$ by increasing the radius to $a + da$. The number of added cases is to the first order measured by $4\pi a^2 da$. Therefore the mean of distances of points on the surface from the given internal point O is

$$\pi\left(4a^3 + \frac{4}{3}c^2a\right)da / 4\pi a^2 da = a + \frac{1}{3} \frac{c^2}{a}.$$

8. Find the mean distance of points between the surfaces of two concentric spheres of radii a_1, a_2 from an external point P at a distance c from the centre O .

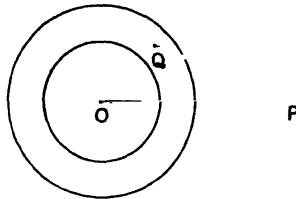

Fig. 491.

Taking Q any point of the shell distant x from the centre, the mean value of PQ is $c + \frac{1}{3} \frac{x^2}{c}$, and the number of cases between the spheres of radii $x, x + dx$ is $4\pi x^2 dx$. The sum of the cases for this thin shell is therefore $4\pi x^2 dx \left(c + \frac{1}{3} \frac{x^2}{c}\right)$; \therefore for the shell of finite thickness,

$$M(PQ) = \frac{\int_{a_1}^{a_2} 4\pi x^2 \left(c + \frac{1}{3} \frac{x^2}{c}\right) dx}{\int_{a_1}^{a_2} 4\pi x^2 dx} = c + \frac{1}{5c} \frac{a_2^5 - a_1^5}{a_2^3 - a_1^3}.$$

9. Find the mean distance of points within a sphere of radius a and centre O from points within an external concentric spherical shell of internal and external radii a_1 and a_2 . (Fig. 492.)

Let P and Q be two such points, Q lying within the shell, $OQ = x$. For a given position of Q , $M(PQ) = x + \frac{1}{5} \frac{a^2}{x}$. The number of cases is measured by $\frac{4}{3} \pi a^3$, and their sum by $\frac{4}{3} \pi a^3 \left(x + \frac{1}{5} \frac{a^2}{x}\right)$. Now let Q traverse the shell.

Let dV be an element of its volume. Then

$$M(PQ) = \frac{\int_{a_1}^{a_2} \frac{4}{3} \pi a^3 \left(x + \frac{1}{5} \frac{a^2}{x}\right) dV}{\int_{a_1}^{a_2} \frac{4}{3} \pi a^3 dV} = \frac{\int_{a_1}^{a_2} \left(x + \frac{1}{5} \frac{a^2}{x}\right) 4\pi x^2 dx}{\int_{a_1}^{a_2} 4\pi x^2 dx} = \frac{3}{4} \frac{a_2^4 - a_1^4}{a_2^3 - a_1^3} + \frac{3}{10} \frac{a^2 (a_2^2 - a_1^2)}{a_2^3 - a_1^3}.$$

In the particular cases stated below, we have

- (i) $a_1 = a_2$, $M = a_1 + \frac{1}{5} \frac{a^2}{a_1}$; (ii) $a_1 = a_2 = a$, $M = \frac{6a}{5}$;
 (iii) $a = 0$, $M = \frac{3}{4} \frac{(a_1 + a_2)(a_1^2 + a_2^2)}{a_1^2 + a_1 a_2 + a_2^2}$; (iv) $a_1 = a_2$ and $a = 0$, $M = a_1$;
 (v) $a_1 = a$, $M = \frac{3}{20} \frac{(a + a_2)(7a^2 + 5a_2^2)}{a^2 + a a_2 + a_2^2}$; (vi) $a_1 = a = 0$, $M = \frac{3a_2}{4}$.

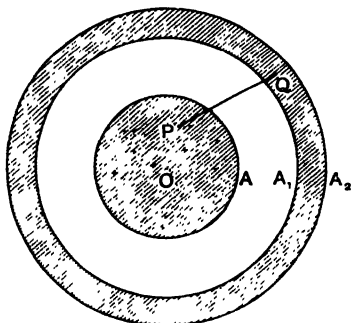

Fig. 492.

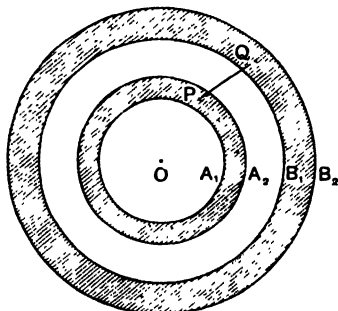

Fig. 493.

10. Find the mean distance of a point P which lies between the surfaces of a spherical shell of inner and outer radii a_1 and a_2 from a point Q , which lies between the surfaces of a concentric spherical shell whose inner and outer radii are b_1 and b_2 ($b_2 > b_1 > a_2 > a_1$). (Fig. 493.)

Let O be the centre, $OQ = x$. For a fixed position of Q ,

$$M(PQ) = x + \frac{1}{5x} \frac{a_2^5 - a_1^5}{a_2^3 - a_1^3},$$

and the number of such cases is measured by $\frac{4}{3}\pi(a_2^3 - a_1^3)$, and their sum by $\frac{4}{3}\pi(a_2^3 - a_1^3) \left[x + \frac{1}{5x} \frac{a_2^5 - a_1^5}{a_2^3 - a_1^3} \right] \equiv F(x)$, say. Hence when Q is free to traverse the outer shell, we have

$$\begin{aligned} M(PQ) &= \frac{\int_{b_1}^{b_2} 4\pi x^2 F(x) dx}{\int_{b_1}^{b_2} 4\pi x^2 dx \times \frac{4}{3}\pi(a_2^3 - a_1^3)} = \frac{\int_{b_1}^{b_2} x^2 \left(x + \frac{1}{5x} \frac{a_2^5 - a_1^5}{a_2^3 - a_1^3} \right) dx}{\int_{b_1}^{b_2} x^2 dx} \\ &= \frac{3}{4} \frac{b_2^4 - b_1^4}{b_2^3 - b_1^3} + \frac{3}{10} \frac{a_2^5 - a_1^5}{a_2^3 - a_1^3} \cdot \frac{b_2^3 - b_1^3}{b_2^3 - b_1^3}. \end{aligned}$$

11. Mean distance of points Q within a sphere of radius a , from points P on the surface of a second of radius b external to the former.

A and B being the respective centres and P a given point on the surface of the second sphere, the mean of distances from P of points within the first $= r + \frac{1}{5} \frac{a^2}{r}$, where $AP = r$.

Hence the sum of the cases is measured by $\frac{4}{3}\pi a^3\left(r + \frac{1}{5}\frac{a^2}{r}\right)$ Hence we are to find for the second sphere $\frac{\int \frac{4}{3}\pi a^3\left(r + \frac{1}{5}\frac{a^2}{r}\right)dS}{\int \frac{4}{3}\pi a^3 dS}$.

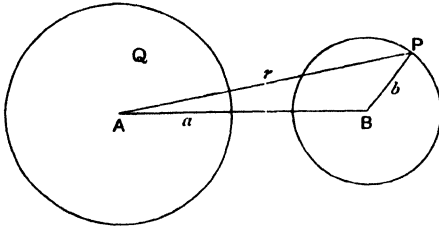

Fig. 494.

Now $\int r dS = 4\pi b^2 \times$ mean distance of points on the second sphere from $A = 4\pi b^2\left(c + \frac{1}{3}\frac{b^2}{c}\right)$
 and $\int \frac{dS}{r} =$ potential of a shell of unit density at the point $A = \frac{4\pi b^3}{c}$;
 \therefore mean value required $= \frac{4\pi b^2\left(c + \frac{1}{3}\frac{b^2}{c}\right) + \frac{4\pi b^3}{c} \cdot \frac{a^3}{5}}{4\pi b^3} = c + \frac{1}{3}\frac{b^2}{c} + \frac{1}{5}\frac{a^3}{c}$.

12. Mean distance of two points Q and P , one on each of two spherical surfaces of radii a and b , each outside the other. A and B being the centres, $r = AP$, the mean of the distances on the

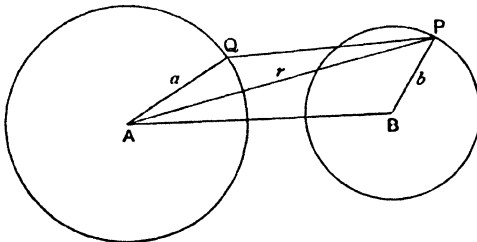

Fig. 495.

surface of the first sphere from $P = r + \frac{1}{3}\frac{a^2}{r}$, and the sum of the cases is measured by $4\pi a^3\left(r + \frac{1}{3}\frac{a^2}{r}\right)$. Hence, we have to find for the second sphere

$$\frac{\int 4\pi a^3\left(r + \frac{1}{3}\frac{a^2}{r}\right)dS}{\int 4\pi a^3 dS} = \frac{\int r dS}{S} + \frac{a^3}{3} \frac{\int \frac{dS}{r}}{S} = c + \frac{1}{3}\frac{b^2}{c} + \frac{1}{3}\frac{a^3}{c}.$$

13. If each of the points in Case 12 be allowed to traverse the interior of its own sphere,

$$M(P'Q) = \frac{\int \frac{4}{3} \pi a^3 \left(r + \frac{1}{5} \frac{a^2}{r} \right) dV}{\int \frac{4}{3} \pi a^3 dV} \text{ taken through the second sphere}$$

$$= \left\{ \frac{4}{3} \pi b^3 \left(c + \frac{1}{5} \frac{b^2}{c} \right) + \frac{1}{5} a^3 \frac{4}{3} \pi \frac{b^3}{c} \right\} / \frac{4}{3} \pi b^3 = c + \frac{1}{5} \frac{a^2}{c} + \frac{1}{5} \frac{b^2}{c}.$$

14. Mean distance between points P and Q , P lying anywhere within a sphere of centre A and radius a , Q within a sphere of centre B and radius b , enclosed entirely by the first.

Let $AB=c$, $BP=r$. First fix P . Then

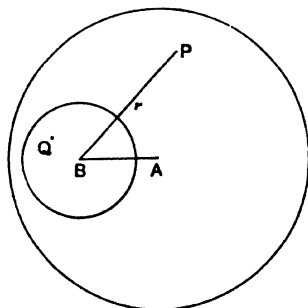

Fig. 496.

(i) if P lie without the smaller sphere

$M(P'Q) = r + \frac{1}{5} \frac{b^2}{r}$, and the number of such cases is measured by $\frac{4}{3} \pi b^2$;

(ii) if P lie within the smaller sphere

$M(P'Q) = \frac{3}{4} b + \frac{r^2}{2b} - \frac{1}{20} \frac{r^4}{b^3}$, the number of cases being, as before, measured by $\frac{4}{3} \pi b^3$.

The sums of the cases are therefore

$$\frac{4}{3} \pi b^2 \left(r + \frac{1}{5} \frac{b^2}{r} \right)$$

and $\frac{4}{3} \pi b^3 \left(\frac{3}{4} b + \frac{r^2}{2b} - \frac{r^4}{20b^3} \right).$

These are to be summed for all positions of P . In the second expression, P necessarily lies in the smaller sphere and in the first expression the integral through the shell is the difference of the integrals taken through the two spheres.

The first therefore yields $\frac{4}{3} \pi b^2 \left(\int r dV + \frac{b^2}{5} \int \frac{dV}{r} \right)$, dV being an element of volume,

$$= \frac{4}{3} \pi b^2 \left[\frac{4}{3} \pi a^3 \left(\frac{3a}{4} + \frac{1}{2} \frac{c^2}{a} - \frac{1}{20} \frac{c^4}{a^3} \right) + \frac{b^2}{5} \cdot \frac{2}{3} \pi (3a^2 - c^2) \right] - \frac{4}{3} \pi b^2 \left[\frac{4}{3} \pi b^3 \cdot \frac{3b}{4} + \frac{b^2}{5} \cdot 2\pi b^2 \right].$$

The second yields

$$\int_0^\pi \int_0^{2\pi} \int_0^b \frac{4}{3} \pi b^2 \left(\frac{3}{4} b + \frac{r^2}{2b} - \frac{r^4}{20b^3} \right) r^2 \sin \theta d\theta d\phi dr = \frac{4}{3} \pi b^7 \cdot 2\pi \cdot 2 \cdot \frac{3}{4}.$$

Adding and dividing by $\frac{4}{3} \pi a^3 \times \frac{4}{3} \pi b^3$, the mean value required is

$$\frac{3a}{4} + \frac{c^2}{2a} - \frac{c^4}{20a^3} + \frac{3b^2}{10a} - \frac{1}{10} \frac{b^2 c^2}{a^3} - \frac{3}{140} \frac{b^4}{a^3}.$$

When $c=0$ and $a=b$ this reduces to $\frac{3}{4} a$, the result Ex. 2.

15. Mean distance PQ , where P and Q lie, one within a sphere of centre A and radius a , and the other within a sphere of centre B and radius b , the spheres intersecting, where $AB=c (> a)$.

Let $BP=r$. Fix P . Then, (Fig. 497),

(i) if P lies without the b -sphere, the sum of the cases is measured by

$$\frac{4}{3}\pi b^3\left(r + \frac{b^2}{5r}\right);$$

(ii) if P lies (at P') within the b -sphere, the sum of the cases is measured

$$\text{by } \frac{4}{3}\pi b^3\left(\frac{3}{4}b + \frac{1}{2}\frac{r^2}{b} - \frac{r^4}{20b^3}\right), \text{ where } r \text{ is now } BP'.$$

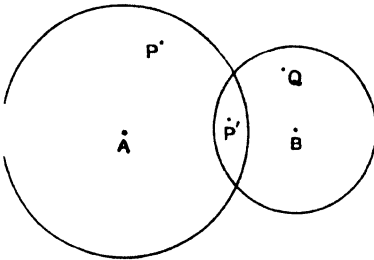

Fig. 497.

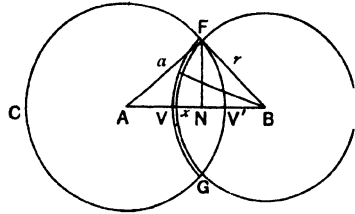

Fig. 498.

We have now to sum $\int \frac{4}{3}\pi b^3\left(r + \frac{b^2}{5r}\right)dV$ for the a -sphere, omitting the lens,

and $\int \frac{4}{3}\pi b^3\left(\frac{3}{4}b + \frac{1}{2}\frac{r^2}{b} - \frac{r^4}{20b^3}\right)dV$ for the lens,

and after addition to divide by the measure of the whole number of compound cases, viz. $\frac{4}{3}\pi a^3 \cdot \frac{4}{3}\pi b^3$.

Now the integration of any function $\phi(r)$ of the distance r of a point P' from an external point B , can be conducted through the region enclosed by the lens as follows :

Let V, V' be the vertices of the lens (Fig. 498). Then if x be distance from V of the common plane section of the sphere of radius a and centre A with the sphere of centre B and radius r , we have

$$x = r - r \frac{r^2 + c^2 - a^2}{2cr} = \frac{a^2 - (r-c)^2}{2c};$$

and if r increases to $r + dr$, the volume of the lens increases by

$$2\pi r \frac{a^2 - (r-c)^2}{2c} dr,$$

this being the volume of the added layer.

Every point of this layer is at the same distance r from B . Hence the integration of $\phi(r)$ through the lens is $\int \phi(r) \frac{\pi}{c} \{a^2 - (r-c)^2\} r dr$ with

limits $c-a$ to b ; and for the rest of the a -sphere with limits from b to $c+a$. And we have

$$\int r^n dV = \frac{\pi}{c} \int r^{n+1} \{(a^2 - c^2) + 2cr - r^2\} dr$$

$$= \frac{\pi}{c} \left\{ (a^2 - c^2) \frac{r^{n+2}}{n+2} + 2c \frac{r^{n+3}}{n+3} - \frac{r^{n+4}}{n+4} \right\} = I_n, \text{ say.}$$

Hence

$$M(PQ) = \frac{3}{4\pi a^3} \left\{ [I_1]_b^{c+a} + \frac{b^2}{5} [I_{-1}]_b^{c+a} + \frac{3b}{4} [I_0]_{c-a}^b + \frac{1}{2b} [I_2]_{c-a}^b - \frac{1}{20b^3} [I_1]_{c-a}^b \right\}.$$

The integrals $[I_{-1}]_b^{c+a}$ and $[I_0]_{c-a}^b$ are interesting from another point of view, and reduce as follows :

$$[I_{-1}]_b^{c+a} = \frac{\pi}{3c} (c+a-b)^2 (2a+b-c), \text{ and is the potential at } B \text{ of the meniscus } FCG \text{ taken as of uniform unit volume density.}$$

$$[I_0]_{c-a}^b = \frac{\pi}{12c} (a+b-c)^2 [(a+b+c)^2 - 4(a^2 - ab + b^2)], \text{ and is the volume of the double-convex lens.}$$

1657. Mean Square of Distance between Two Points.

Let P and P' be random points in the respective regions R and R' , which may be one-, two- or three-dimensional. Let

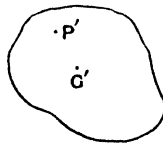
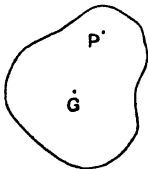

Fig 499.

G, G' be the respective centroids of these regions for a uniform mass-distribution, and the line, surface or volume density, as the case may be, be taken as unity. Let

H and H' be the moments of inertia with regard to the respective centroids, viz. ΣmGP^2 and $\Sigma m'G'P'^2$. Then taking R, R' as the lengths, areas or volumes of the regions, as the case may be,

$$M(\rho^2) = GG'^2 + H/R + H'/R'.$$

For $M(\rho^2) = \iint PP'^2 dR dR' / \iint dR dR',$

and $\int PP'^2 dR' = R' \cdot PG'^2 + H';$

(Lagrange's Theorem, Routh, *A. St.*, I. 436.)

$$\iint PP'^2 dR' dR = \int (R' \cdot PG'^2 + H') dR = R' (R \cdot GG'^2 + H) + H' \cdot R;$$

also $\iint dR dR' = R \cdot R; \therefore M(\rho^2) = GG'^2 + H/R + H'/R'.$

The values of H and H' are known for many elementary cases.

Cor. I. Centroids coincident, $GG' = 0$, $M(\rho^2) = H/R + H'/R'$.

Cor. II. (i) Regions identical, $M(\rho^2) = 2H/R$.

(ii) If the region be a plane lamina,

$$H/R = \text{sq. of radius of gyration} = k^2; \quad \therefore M(\rho^2) = 2k^2.$$

1658. EXAMPLES.

1. For two ellipses, semi-axes (a, b) and (a', b') , lying in the same plane, c the distance between the centres, $M(\rho^2) = (a^2 + b^2 + a'^2 + b'^2)/4 + c^2$.

2. If R and R' be the same square of side a , $M(\rho^2) = a^2/3$.

3. If R and R' be the same sphere of radius a , within which each point may move, $M(\rho^2) = 6a^2/5$.

4. If R and R' be the same sphere of radius a , on the surface of which each point may move, $M(\rho^2) = 2a^2$.

5. If P moves on the surface of a sphere, and P' on a diametral plane, $M(\rho^2) = 3a^2/2$.

6. If P moves on the surface of a sphere, and P' on a great circle, $M(\rho^2) = 2a^2$.

7. If P and P' move one on each of two straight lines of lengths $2a, 2b$, whose centres are a distance c apart, $M(\rho^2) = c^2 + (a^2 + b^2)/3$.

If the lines be identical, $M(\rho^2) = 2a^2/3$,

with the same result if not identical, but with the same centre and of the same length.

1659. If one of the two points be fixed, say P' , and P traverses a region R , then taking P' as origin O . Then

$$M(\rho^2) = \int OP^2 dR / \int dR = OG^2 + H/R.$$

1660. EXAMPLES.

1. If O be the centre of a square of side $2a$ which P may traverse, $M(\rho^2) = 2a^2/3$.

2. If O be a point at distance c from the centre of a circle of radius a in any position which P may traverse, $M(\rho^2) = c^2 + a^2/2$.

3. If O be the centre of an ellipsoid of semi-axes a, b, c , throughout which the free point may travel, $M(\rho^2) = (a^2 + b^2 + c^2)/5$.

If O be the extremity of the a -axis, $M(\rho^2) = a^2 + (a^2 + b^2 + c^2)/5$.

4. If P lies on the circumference of a semicircle and P' on the diameter, of length $2a$,

$$M(\rho^2) = \frac{4a^2}{\pi^2} + \pi a \left(a^2 - \frac{4a^2}{\pi^2} \right) / \pi a + \frac{a^2}{3} = 4a^2/3.$$

Otherwise :—with the notation of Fig. 500,

$$M(\rho^2) = \frac{\int_0^\pi \int_{-a}^a (a^2 - 2ax \cos \theta + x^2) d\theta dx}{\int_0^\pi \int_{-a}^a d\theta dx} = \frac{1}{2\pi a} \int_0^\pi \left(2a^2 + \frac{2a^3}{3} \right) d\theta = \frac{4a^2}{3}.$$

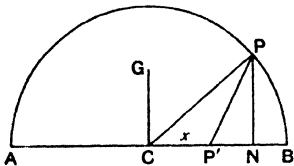

Fig. 500.

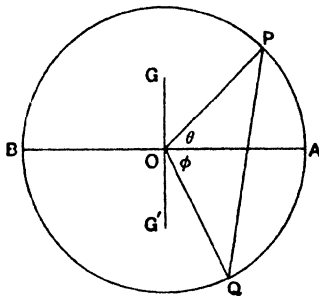

Fig. 501.

5. If P lies on the circumference of a circle, and on one side of a given diameter AB and P' on the opposite semi-circumference, $GG' = 4a/\pi$;

$$\therefore M(\rho^2) = \frac{16a^2}{\pi^2} + 2\left(a^2 - \frac{4a^2}{\pi^2}\right) = \frac{2a^2}{\pi^2}(\pi^2 + 4).$$

Otherwise :—If O be the centre, $A\hat{O}P = \theta$, $A\hat{O}Q = \phi$, (Fig. 501),

$$M(\rho^2) = \int_0^\pi \int_0^\pi 4a^2 \sin^2 \frac{\theta + \phi}{2} d\theta d\phi / \int_0^\pi \int_0^\pi d\theta d\phi = \frac{2a^2}{\pi^2} \int_0^\pi \int_0^\pi \{1 - \cos(\theta + \phi)\} d\theta d\phi \\ = \text{etc.} = 2a^2(\pi^2 + 4)/\pi^2.$$

1661. Mean n^{th} Power of Distance between two points P and Q .

EXAMPLES.

1. Let AB be a given straight line of length a ; P and Q two random points upon AB , P being the one more distant from A ; $AP = x$, $AQ = y$.

$$M(QP^n) = \int_0^a \int_0^x (x-y)^n dx dy / \int_0^a \int_0^x dx dy = \int_0^a \left[-\frac{(x-y)^{n+1}}{n+1} \right]_{y=0}^{y=x} dx / \int_0^a x dx \\ = \frac{1}{n+1} \int_0^a x^{n+1} dx / \int_0^a x dx = 2a^n / (n+1)(n+2).$$

2. If P lies on the circumference of a circle, and Q be at a fixed point O of the circumference, C the centre, (Fig. 502),

$$M(OP^n) = 2 \int_0^{\frac{\pi}{2}} OP^n \cdot 2a d\theta / \text{circumf.} = \frac{2}{\pi} (2a)^n \int_0^{\frac{\pi}{2}} \cos^n \theta d\theta = \frac{2^{n+1} a^n}{\pi} K_1;$$

where $K_1 = \frac{(n-1)(n-3)\dots 2}{n(n-2)\dots 3}$ (n odd) or $\frac{(n-1)\dots 1}{n\dots 2} \cdot \frac{\pi}{2}$ (n even).

3. If P lie within the circle, and Q be at O , (Fig. 503),

$$M(OP^n) = 2 \int_0^{\frac{\pi}{2}} \int_0^{2a \cos \theta} r^n \cdot r \, d\theta \, dr / \text{area} = \frac{2^{n+3} a^n}{(n+2)\pi} K_2,$$

where
$$K_2 = \int_0^{\frac{\pi}{2}} \cos^{n+2} \theta \, d\theta = \text{etc.}$$

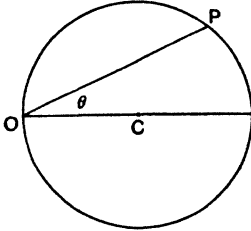

Fig. 502.

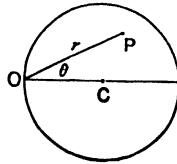

Fig. 503.

4. If P and Q both lie within a circle of radius a , $M(PQ^n)$ may be inferred from the last result. Let M be the result required. The number of cases is measured by $\pi a^2 \times \pi a^2$ and their sum is measured by $M\pi^2 a^4$. If the radius be increased to $a + da$, the increase in the sum $= \frac{d}{da} (M\pi^2 a^4) da$. This increase is brought about by the addition of the cases in which P or Q or both lie on the annulus, and is

$$2 \cdot 2\pi a \, da \cdot \pi a^2 \frac{2^{n+3} a^n}{(n+2)\pi} K_2 + 2\pi a \, da \cdot 2\pi a \, da \cdot \frac{2^{n+1} a^n}{\pi} K_1,$$

the first factor 2 being inserted because either P or Q may lie on the annulus, and the second term arises for the case in which both lie on the annulus, but is a second-order infinitesimal.

Hence, M vanishing with a , no constant of integration is required, and

$$\frac{d}{da} (M\pi^2 a^4) = \frac{2^{n+3} a^{n+3}}{n+2} \pi K_2; \quad \therefore M = \frac{2^{n+3} a^n}{(n+2)(n+4)} \frac{K_2}{\pi}.$$

[The result was given by the Rev. T. C. Simmons, *Educ. Times*, 7943, p. 120, vol. xliii., a different proof being adopted.]

5. If P lies on the surface of a sphere of radius a and Q is at a fixed point O of the surface, then, ($n > 0$),

$$M(OP^n) = \frac{1}{4\pi a^2} \int_0^{\frac{\pi}{2}} (2a \cos \theta)^n 2\pi (2a \sin \theta \cos \theta) 2a \, d\theta = 2(2a)^n / (n+2).$$

6. If P and Q are both free to move on the surface of the sphere and

$$n > 1, \quad M(PQ^n) = \iint r^n \, dS \, dS / \iint dS \, dS = \text{etc.} = 2(2a)^n / (n+2).$$

[This result might be inferred from Ex. 5.]

7. If P lies within the sphere and Q is at a fixed point O on the surface,

$$M(OP^n) = 12(2a)^n / (n+3)(n+4).$$

8. If P lies within the sphere and Q be at the centre C ,

$$M(OP^n) = 3a^n/(n+3). \quad [\text{ST JOHN'S COLL., 1883.}]$$

9. If both P and Q lie within the sphere, proceed as in Ex. 4.

Then $M(PQ^n) = 2^{n+3} \cdot 3^2 a^n / (n+3)(n+4)(n+6)$.

10. If one point lie within the sphere and the other lie at a fixed point O without the sphere, let OQQ' be a chord through P , C the centre, $\hat{C}OQ = \theta$, a the radius, $CO = c$, $OP = r$,

$$M(OP^n) = \iiint r^n \cdot r^2 \sin \theta \, d\theta \, d\phi \, dr / \text{vol.} = \frac{3}{4\pi a^3} \cdot \frac{2\pi}{n+3} \int (OQ'^{n+3} - OQ^{n+3}) \sin \theta \, d\theta,$$

and OQ, OQ' are the roots of $\rho^2 - 2c\rho \cos \theta + c^2 - a^2 = 0$.

For the evaluation of this integral it is convenient to take QQ' as the variable when n is odd and θ as the variable when n is even. There are two algebraical identities useful in such cases. Let $r_1 + r_2 = s$, $r_1 - r_2 = d$, $r_1 r_2 = p$.

Then, by putting into Partial Fractions $(x^2 - sx + p)^{-1}$, expanding both sides in inverse powers of x , and equating coefficients of $1/x^{m+1}$,

$$\frac{r_1^m - r_2^m}{r_1 - r_2} = s^{m-1} - (m-2)s^{m-3}p + \frac{(m-3)(m-4)}{1 \cdot 2} s^{m-5}p^2 - \dots$$

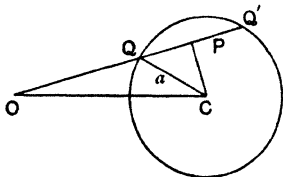

Fig. 504

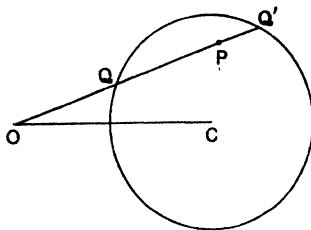

Fig. 505.

If m be odd, the indices of s are all even. Substituting for s^2 its value $d^2 + 4p$ and expanding each term, the series all terminate, and we obtain

$$r_1^m - r_2^m = d^m + md^{m-2}p + \frac{m(m-3)}{1 \cdot 2} d^{m-4}p^2 + \frac{m(m-4)(m-5)}{1 \cdot 2 \cdot 3} d^{m-6}p^3 + \dots \quad \dots (A)$$

If m be even,

$$\frac{r_1^m - r_2^m}{ds} = s^{m-2} - (m-2)s^{m-4}p + \frac{(m-3)(m-4)}{1 \cdot 2} s^{m-6}p^2 - \dots$$

$$= (d^2 + 4p)^{\frac{m-2}{2}} - (m-2)(d^2 + 4p)^{\frac{m-4}{2}} p + \frac{(m-3)(m-4)}{1 \cdot 2} (d^2 + 4p)^{\frac{m-6}{2}} p^2 - \dots ;$$

whence, expanding as before, the series all terminate and, m even,

$$r_1^m - r_2^m = sd \left\{ d^{m-2} + (m-2)d^{m-4}p + \frac{(m-3)(m-4)}{1 \cdot 2} d^{m-6}p^2 + \dots \right\}. \quad \dots (B)$$

(i) Suppose, for instance, $n=3$, $m=6$. Let $QQ' = x$,

$$\begin{aligned} M(OP^3) &= \frac{3}{4\pi a^3} \cdot \frac{2\pi}{6} \int (r_1^6 - r_2^6) \sin \theta \, d\theta \\ &= \frac{1}{4a^3} \int sx(x^4 + 4px^2 + 3p^2) \sin \theta \, d\theta \quad (\text{from B}). \end{aligned}$$

Also

$$s = 2c \cos \theta, \quad r^2 = 4(a^2 - c^2 \sin^2 \theta), \quad p = c^2 - a^2, \quad x dx = -4c^2 \sin \theta \cos \theta d\theta;$$

whence $s \cdot \sin \theta d\theta = -x dx/2c,$

$$\text{and } M(OP^3) = -\frac{1}{8a^3c} \int_{2a}^0 (x^6 + 4px^4 + 3p^2x^2) dx = c^3 + \frac{6}{5}a^2c + \frac{3}{35}\frac{a^4}{c}.$$

(ii) Suppose $n=4, m=7,$

$$M(OP^4) = \frac{3}{4\pi a^3} \frac{2\pi}{7} \int (r_1^7 - r_2^7) \sin \theta d\theta$$

$$= \frac{3}{14a^3} \int_0^{\sin^{-1} \frac{a}{c}} c^7 (x^7 + 7px^5 + 14p^2x^3 + 7p^3x) \sin \theta d\theta.$$

Let $I_r = \int_0^{\sin^{-1} \frac{a}{c}} x^r \sin \theta d\theta.$ Put $P = x^r \cos \theta, \quad x dx = -4c^2 \sin \theta \cos \theta d\theta,$

$$\frac{dP}{d\theta} = \text{etc.} = -(r+1)x^r \sin \theta - 4prx^{r-2} \sin \theta; \quad \therefore I_r = \frac{(2a)^r}{r+1} - \frac{4r}{r+1} p I_{r-2}.$$

Using this reduction formula, we may show that

$$I_7 + 7pI_5 + 14p^2I_3 + 7p^3I_1 = \frac{(2a)^7}{8} + \frac{7}{2 \cdot 6} (2a)^5 p + \frac{7}{3 \cdot 4} (2a)^3 p^2,$$

and finally $M(OP^4) = c^4 + 2a^2c^2 + \frac{2}{3}a^4.$

11. Find the mean value of x^{2n} for all points on a spherical surface with centre at the origin and radius $a,$ the distribution being for equal surface elements.

$$M(x^{2n}) = \frac{1}{4\pi a^2} \int_0^\pi (a \cos \theta)^{2n} \cdot 2\pi a \sin \theta \cdot a d\theta = \frac{a^{2n}}{2n+1}.$$

$M(x^{2n+1})$ is evidently zero. For the values of x^{2n+1} for which x is negative, cancel the corresponding ones for which x is positive.

12. Find the mean value of $(lx + my + nz)^{2p}$ taken over the same spherical surface.

Changing the axes so that $lx + my + nz = 0$ becomes the new $y-z$ plane, $lx + \dots = X\sqrt{l^2 + \dots},$ and

$$M[(lx + my + nz)^{2p}] = (l^2 + m^2 + n^2)^p a^{2p} / (2p + 1).$$

13. Find $M(x^{2p}y^{2q}z^{2r})$ over the same spherical surface.

Let $p + q + r = k.$

$$\text{Then } \frac{(2k)!}{(2p)!(2q)!(2r)!} \int x^{2p}y^{2q}z^{2r} dS$$

$$= \text{coef. } l^{2p}m^{2q}n^{2r} \text{ in } (l^2 + m^2 + n^2)^k \cdot \int X^{2k} dS$$

$$= \text{coef. } l^{2p}m^{2q}n^{2r} \text{ in } (l^2 + m^2 + n^2)^k \cdot 4\pi a^{2k+3} / (2k+1)$$

$$= \frac{k!}{p!q!r!} \frac{4\pi a^{2k+3}}{2k+1};$$

$$\therefore M(x^{2p}y^{2q}z^{2r}) = \frac{k!}{(2k)!} \frac{(2p)!(2q)!(2r)!}{p!q!r!} \frac{a^{2(p+q+r)}}{2p+2q+2r+1}.$$

14. Find $M(Px^{2p}y^{2q}z^{2r})$ taken over the surface of an ellipsoid of superficial area A , semi-axes a, b, c , where P is the central perpendicular on a tangent plane, the distribution being for equal elements of area.

$$M(Px^{2p}y^{2q}z^{2r}) = \frac{1}{A} \int Px^{2p}y^{2q}z^{2r} dS. \quad \text{Then writing } \frac{x}{a} = \frac{\xi}{R}, \quad \frac{y}{b} = \frac{\eta}{R}, \quad \frac{z}{c} = \frac{\zeta}{R},$$

$$\frac{1}{3} P dS = \frac{1}{3} \frac{abc}{R^3} \cdot R d\sigma,$$

where $d\sigma$ is the corresponding surface element on the sphere $\xi^2 + \eta^2 + \zeta^2 = R^2$, we have as the mean value required

$$\frac{1}{A} \frac{a^{2p}b^{2q}c^{2r}}{R^{2p+2q+2r}} \cdot \frac{abc}{R^3} \cdot R \int \xi^{2p}\eta^{2q}\zeta^{2r} d\sigma = \frac{k!}{(2k)!} \frac{(2p)!(2q)!(2r)!}{p!q!r!} \frac{4\pi}{2k+1} \frac{a^{2p+1}b^{2q+1}c^{2r+1}}{A}$$

where $p+q+r=k$. (See Routh, *Rig. Dyn.*, pp. 7 and 8.)

1662. Mean Areas and Volumes.

EXAMPLES.

1. Find the mean value of the areas of all triangles which can be found by taking at random three points on the circumference of a circle of radius R .

Let O be the centre, ABC a specimen of the triangles; $\widehat{AOB} = \theta$, $\widehat{BOC} = \phi$.

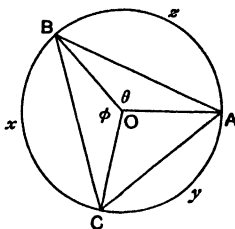

Fig. 506.

We may fix A . ϕ varies from 0 to $2\pi - \theta$, and θ from 0 to 2π . Then

$$M(\triangle ABC) = \frac{R^2}{2} \frac{\int_0^{2\pi} \int_0^{2\pi-\theta} \{\sin \theta + \sin \phi - \sin(\theta + \phi)\} d\theta d\phi}{\int_0^{2\pi} \int_0^{2\pi-\theta} d\theta d\phi} = \text{etc.} = 3R^2/2\pi.$$

2. Find the mean of the areas of all acute-angled triangles inscribable as in Ex. 1.

Here $\theta < \pi$, $\phi < \pi$, $2\pi - \theta - \phi < \pi$. The limits are therefore $\theta = 0$ to π , $\phi = \pi - \theta$ to π , and the mean $= 3R^2/\pi$.

3. Find the mean area of all right-angled triangles inscribed as before.

Take A as the right angle. Then $\phi = \pi$ and the mean $= 2R^2/\pi$, and there are the same number of cases with the same sums if B or C be the right angle. Hence the mean $= 2R^2/\pi$.

4. Find the mean area of all obtuse-angled triangles inscribed as above.

Let A be the obtuse angle. Here $\theta < \pi$, $\phi > \pi$, $2\pi - \theta - \phi < \pi$. Then the limits for θ are 0 and π , and for ϕ , π and $2\pi - \theta$, and the mean $= R^2/\pi$.

5. Find the mean area of all triangles formed by joining three random points on a sphere of radius a . [MATH. TRIP., 1883.]

Let O be the centre. Consider first all the circular sections normal to a given direction OA . Let P be any point on this circle, PN a perpendicular on OA . $\widehat{AOP} = \chi$. Then the mean area of all triangles inscribed in this circle $= 3a^2 \sin^2 \chi / 2\pi$, and the number of such triangles is measured by $2\pi^2$ (Ex. 1). Therefore the mean for all triangles perpendicular to the line OA for equal increments of χ is $\int_0^\pi \frac{3a^2 \sin^2 \chi}{2\pi} d\chi / \pi = 3a^2 / 4\pi$, and the mean is obviously the same for all directions of OA , since the number of cases and the sum of the cases is the same for each direction of OA . (Fig. 507.)

A distribution of different nature, e.g. for equal increments of x , would give a different result, viz. $\frac{1}{2a} \int_{-a}^a \frac{3NP^2}{2\pi} dx = a^2 / \pi$.

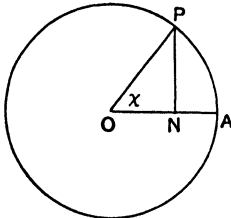

Fig. 507.

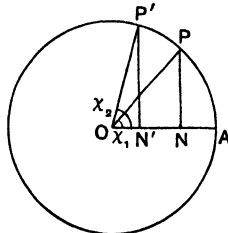

Fig. 508.

6. Find the mean value of the volume of a tetrahedron whose angular points are four random points on a sphere of radius a . (Fig. 508.) [MATH. TRIP., 1883.]

Without affecting the problem, we may take a set of bases fixed in direction, say normal to a given radius OA . Let one of the bases be on the circular section through the ordinate PN . Then, as the vertex of the tetrahedron travels in a circular section parallel to the base and through a second ordinate $P'N'$, the volume remains constant. Therefore the mean volume of the tetrahedron, with vertices on the plane through $P'N'$ and bases on the plane through PN

$$= \frac{1}{3} NN' \cdot \frac{3NP^2}{2\pi}. \text{ Let } \widehat{AOP} = \chi_1, \widehat{AOP'} = \chi_2.$$

The measure NN' of the perpendicular height of the tetrahedron changes sign as N' passes through N . To avoid negative signs for the volumes of tetrahedra with vertices on opposite sides of their respective bases, we separate the integration into two parts. The expression for the mean volume required is then

$$\int_0^\pi \int_{\chi_1}^{\pi-\chi_1} \frac{1}{3} \cdot \frac{3NP^2}{2\pi} a(\cos \chi_1 - \cos \chi_2) d\chi_1 d\chi_2 + \int_0^\pi \int_0^{\chi_1} \frac{1}{3} \cdot \frac{3NP^2}{2\pi} a(\cos \chi_2 - \cos \chi_1) d\chi_1 d\chi_2$$

$$\int_0^\pi \int_0^\pi d\chi_1 d\chi_2$$

which, after integration, gives $16a^3/9\pi^3$.

The distribution here taken is for equal increments of χ_1 and χ_2 .

7. If P, Q, R be random points on the three sides BC, CA, AB of a triangle, find the mean values of the triangles AQR, BRP, CPQ, PQR .

[R. CHARTRES, *Educ. Times.*]

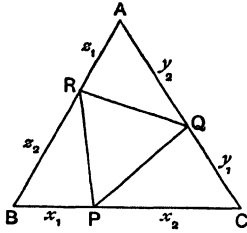

Fig. 509.

Let $x_1, x_2; y_1, y_2; z_1, z_2$ be the respective parts into which the sides are divided at P, Q, R ; Δ the area of the triangle ABC ,

$$M(AQR) = \int_0^b \int_0^c \frac{y_2 z_1}{bc} \Delta dy_2 dz_1 / \int_0^b \int_0^c dy_2 dz_1 = \frac{\Delta}{4}.$$

Similarly

$$M(BRP) = M(CPQ) = \frac{\Delta}{4}.$$

$$M(PQR) = \int_0^a \int_0^b \int_0^c \left(1 - \frac{y_2 z_1}{bc} - \frac{z_2 x_1}{ca} - \frac{x_2 y_1}{ab}\right) \Delta dx_1 dy_1 dz_1 / \int_0^a \int_0^b \int_0^c dx_1 dy_1 dz_1 = \text{etc.} = \frac{\Delta}{4}.$$

1663. **Miscellaneous Mean Values.**

EXAMPLES.

1. The value of a diamond being proportional to the square of its weight, prove that, if a diamond be broken into three pieces, the mean value of the three pieces together is half the value of the whole diamond. [M. TRIP., 1875.]

Let x, y, z be the weights of the portions, W that of the whole. Then we have to find the mean value of $x^2 + y^2 + z^2$, where $x + y + z = W$. Refer-

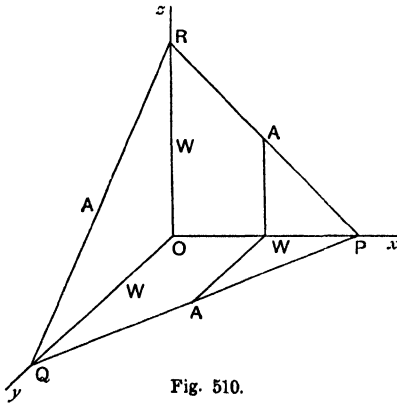

Fig. 510.

ring to Cartesian coordinates, $x + y + z = W$ is the equation of a plane. If $d\sigma$ be an element of area of the intercepted triangle, the mean value is

$$\int (x^2 + y^2 + z^2) d\sigma / \int d\sigma = (\text{mom. of in. with respect to the origin}) / \text{area} = \frac{1}{2} (\text{the sum of the moments of in. about the axes}) / \text{area}.$$

Let $3A$ be the area of the triangle. Then, concentrating A at each mid-point (Routh, *Rig. Dyn.*, Art. 35),

$$\text{Mean value} = \frac{1}{2} \cdot 3 \left[A \left(\frac{W}{2}\right)^2 + A \left(\frac{W}{2}\right)^2 + A \left\{ \left(\frac{W}{2}\right)^2 + \left(\frac{W}{2}\right)^2 \right\} \right] / 3A = \frac{1}{2} W^2.$$

2. It is required to find the mean value of the inverse distances of points on a circle of radius a , from points on a fixed diameter AB .

Let P be a point on the arc, Q a point on the diameter, O the centre.

$\widehat{POB} = \theta$, $\widehat{POA} = \theta' = \pi - \theta$, $\widehat{PAB} = \phi_1$, $\widehat{PBA} = \phi_2$, $PQ = \rho$, $OQ = x$.

Then $\theta = 2\phi_1$, $\theta' = 2\phi_2$. (Fig. 511.)

$$M\left(\frac{1}{\rho}\right) = \int_0^\pi \int_{-a}^a \frac{a \, d\theta \, dx}{\rho} \bigg/ \int_0^\pi \int_{-a}^a a \, d\theta \, dx.$$

Now $\int_{-a}^a \frac{dx}{\rho}$ is the potential at P of a material line AB of unit line density = $\log \cot \frac{\phi_1}{2} \cot \frac{\phi_2}{2}$ (Art. 1652).

$$\begin{aligned} M\left(\frac{1}{\rho}\right) &= \frac{1}{2\pi a} \left\{ \int_0^\pi \log \cot \frac{\phi_1}{2} \, d\theta + \int_0^\pi \log \cot \frac{\phi_2}{2} \, d\theta \right\} \\ &= \frac{1}{\pi a} \left\{ \int_0^{\frac{\pi}{2}} \log \cot \frac{\phi_1}{2} \, d\phi_1 + \int_0^{\frac{\pi}{2}} \log \cot \frac{\phi_2}{2} \, d\phi_2 \right\} = \frac{2}{\pi a} \int_0^{\frac{\pi}{2}} \log \cot \frac{\chi}{2} \, d\chi \\ &= 4s'_2/\pi a. \quad (\text{Art. 1074.}) \end{aligned}$$

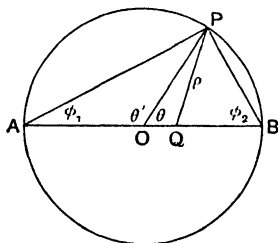

Fig. 511.

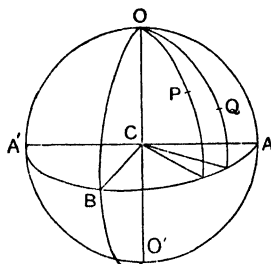

Fig. 512.

3. O is a fixed point on the circumference of the base of a hemisphere with centre C . P and Q are random points on the surface; find the mean value of the angle between the planes OCP , OCQ . (Fig. 512.) [CAIUS COLL., 1877.]

Let $AOA'O'$ be the base of the hemisphere, and B its vertex, C the centre, CA , CB , CO being taken as the rectangular coordinate axes. Let ϕ_1 and ϕ_2 be the azimuthal angles of the two planes OCP , OCQ , P being taken as the point on the plane with the greater azimuthal angle. Then if the distribution of the points P , Q be one for equal elements of area, the mean required is

$$\frac{\int_0^\pi \int_0^\pi \int_0^\pi \int_0^{\phi_1} (\phi_1 - \phi_2) \sin \theta_1 \sin \theta_2 \, d\theta_1 \, d\theta_2 \, d\phi_1 \, d\phi_2}{\int_0^\pi \int_0^\pi \int_0^\pi \int_0^{\phi_1} \sin \theta_1 \sin \theta_2 \, d\theta_1 \, d\theta_2 \, d\phi_1 \, d\phi_2} = \text{etc.} = \pi/3.$$

4. Prove that if $2c$ be the distance between the foci of an ellipse of semi-axes a and b , the mean value of $r_1^{-2} r_2^{-2} f\{\frac{1}{4}(r_1 + r_2)^2 - c^2\}$, with respect to the area, is equal to $\frac{1}{ab} \int_0^{b^2} \frac{f(\lambda) d\lambda}{\lambda(c^2 + \lambda)}$; r_1, r_2 being the focal radii of any point within the ellipse. (Fig. 513.) [7, 1890.]

Taking $\frac{x^2}{c^2 + \lambda} + \frac{y^2}{\lambda} = 1$, $\frac{x^2}{c^2 - \mu} - \frac{y^2}{\mu} = 1$ as confocals through the point,

$$r_1^2 = (c+x)^2 + y^2, \quad r_2^2 = (c-x)^2 + y^2, \quad r_1^2 - r_2^2 = 4cx,$$

$$r_1 + r_2 = 2\sqrt{c^2 + \lambda}, \quad r_1 - r_2 = 2\sqrt{c^2 - \mu},$$

$$cx = \sqrt{(c^2 + \lambda)(c^2 - \mu)}, \quad cy = \sqrt{\lambda\mu}, \quad \frac{1}{4}(r_1 + r_2)^2 - c^2 = \lambda, \quad \lambda + \mu = r_1 r_2,$$

$$\frac{\partial(x, y)}{\partial(\lambda, \mu)} = \frac{1}{4} \frac{r_1 r_2}{c^2 xy}.$$

$$\text{Mean required} = \iint \frac{dx dy}{r_1^2 r_2^2} f(\lambda) / \iint dx dy = \frac{4}{\pi ab} \iint \frac{dx dy}{r_1^2 r_2^2} f(\lambda),$$

the integration being taken through the first quadrant,

$$\begin{aligned} &= \frac{4}{\pi ab} \int_0^{b^2} \int_0^{c^2} \frac{1}{4} \frac{1}{\lambda + \mu} \frac{f(\lambda) d\lambda d\mu}{\sqrt{\lambda\mu} \sqrt{(c^2 + \lambda)(c^2 - \mu)}} \\ &= \frac{1}{\pi ab} \int_0^{b^2} \frac{f(\lambda) d\lambda}{\sqrt{\lambda} \sqrt{c^2 + \lambda}} \int_0^{c^2} \frac{d\mu}{(\lambda + \mu) \sqrt{\mu} \sqrt{c^2 - \mu}}. \end{aligned}$$

Let $\mu = \frac{c^2}{2} (1 - \cos \theta), \quad d\mu = \frac{c^2}{2} \sin \theta d\theta.$

$$\therefore \int_0^{c^2} \frac{d\mu}{(\lambda + \mu) \sqrt{\mu} \sqrt{c^2 - \mu}} = \int_0^\pi \frac{d\theta}{\lambda + c^2 \sin^2 \frac{\theta}{2}} = \frac{\pi}{\sqrt{\lambda(\lambda + c^2)}}.$$

Hence the mean required = $\frac{1}{ab} \int_0^{b^2} \frac{f(\lambda) d\lambda}{\lambda(c^2 + \lambda)}$.

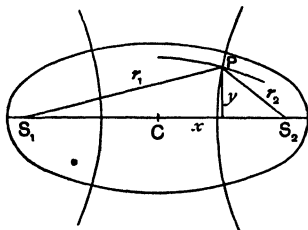

Fig. 513.

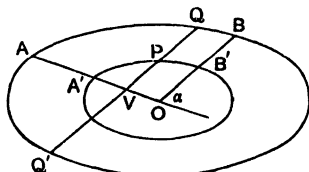

Fig. 514.

5. Through P , any point within an ellipse, a chord QPQ' is drawn parallel to a given semi-diameter ρ . Show that the mean value of $\phi(QP \cdot PQ')$ for all points within the ellipse is

$$2 \int_0^{\frac{\pi}{2}} \phi(\rho^2 \cos^2 \theta) \sin \theta \cos \theta d\theta. \quad [\delta, 1885.]$$

Draw a similar and similarly situated ellipse through P . (Fig. 514.)

Then $QP \cdot PQ'$ retains the same value for all points on this ellipse, viz. $OB^2 - OB'^2 = \rho^2 \cos^2 \theta$, where $\rho = OB$ and $\sin \theta$ is the ratio $OB' : OB$.

If A and A' be the areas of the larger and smaller ellipses,

$$A' = A \sin^2 \theta \quad \text{and} \quad dA' = 2A \sin \theta \cos \theta d\theta.$$

$$\therefore M\{\phi(QP, PQ')\} = \frac{\int \phi(QP, PQ') dA'}{\int dA'} = 2 \int_0^{\frac{\pi}{2}} \phi(\rho^2 \cos^2 \theta) \sin \theta \cos \theta d\theta.$$

6. *Ellipses are drawn with the same major axis $2a$ and any eccentricities; show that the mean length of their perimeters is*

$$2a \left\{ 1 + \int_0^{\frac{\pi}{2}} \frac{\theta}{\sin \theta} d\theta \right\} = 2a \left\{ 1 + 2 \left(1 - \frac{1}{3^2} + \frac{1}{5^2} - \frac{1}{7^2} + \dots \right) \right\}.$$

[ST. JOHN'S, 1886.]

Taking all eccentricities as equally likely, the mean perimeter is

$$4a \int_0^1 \int_0^{\frac{\pi}{2}} \sqrt{1 - e^2 \sin^2 \psi} d\psi de / \int_0^1 de. \quad (\text{Art. 567.})$$

Now

$$\begin{aligned} \int_0^1 \sqrt{1 - e^2 \sin^2 \psi} de &= \sin \psi \int_0^1 \sqrt{\operatorname{cosec}^2 \psi - e^2} de \\ &= \frac{1}{2} \sin \psi \left[e \sqrt{\operatorname{cosec}^2 \psi - e^2} + \operatorname{cosec}^2 \psi \sin^{-1} e \sin \psi \right]_0^1 \\ &= \frac{1}{2} (\cos \psi + \psi \operatorname{cosec} \psi). \end{aligned}$$

\therefore Mean Perimeter

$$\begin{aligned} &= 2a \int_0^{\frac{\pi}{2}} (\cos \psi + \psi \operatorname{cosec} \psi) d\psi = 2a \left\{ 1 + \int_0^{\frac{\pi}{2}} \frac{\psi}{\sin \psi} d\psi \right\} \\ &= 2a \left\{ 1 + 2 \left(\frac{1}{1^2} - \frac{1}{3^2} + \frac{1}{5^2} - \dots \right) \right\}, \text{ by Art. 1074,} \\ &= a \times 5.66386\dots \end{aligned}$$

7. *Show that the average values of the lengths of the least, mean and greatest sides of all possible triangles which can be formed with lines whose lengths lie between a and $2a$ are in the ratio 5 : 6 : 7.* [MATH. TRIP.]

If the sides be taken $a+x$, $a+y$, $a+z$, the ratio of their means is

$$\int_0^a dz \int_0^a dy \int_0^a dx (x+a) : \int_0^a dz \int_0^a dy \int_0^a dx (y+a) : \int_0^a dz \int_0^a dy \int_0^a dx (z+a).$$

8. *Find the mean value of xyz for points within the positive octant of the ellipsoid $a^{-2}x^2 + b^{-2}y^2 + c^{-2}z^2 = 1$.* [OX. II., 1890.]

Use Dirichlet's integral, Art. 962. $M(xyz) = abc/8\pi$.

9. If a point be taken at random within a tetrahedron, then, of all parallelepipeds which can be described having the line joining the point to one of the angular points as diagonal and its edges parallel to the edges of the tetrahedron which meet at that point, the average volume is one twentieth that of the tetrahedron.

10. Show that for positive values of x, y, z , with condition

$$a^{-2}x^2 + b^{-2}y^2 + c^{-2}z^2 = 1, \text{ and } r \text{ being } > 1,$$

the mean value of $(xyz)^{r-1}$ for an equable distribution of area on the xy plane is

$$(abc)^{r-1} \left\{ \Gamma\left(\frac{r}{2}\right) \right\}^2 \Gamma\left(\frac{r+1}{2}\right) / \pi \Gamma\left(\frac{3r+1}{2}\right),$$

which for $r=2$ reduces to $4abc/15\pi$.

11. Find the mean value of $(xyz)^{r-1}$, $r > 0$, where x, y, z are areal coordinates for points within the triangle of reference.

We require
$$\frac{\iint x^{r-1}y^{r-1}(1-x-y)^{r-1} dx dy}{\iint dx dy}$$

for positive values of x, y, z (see Art. 975) $= 2\{\Gamma(r)\}^3/\Gamma(3r)$.

12. Show that if x, y, z, u are the tetrahedral coordinates of a point within the reference tetrahedron, $M\{(xyz u)^{r-1}\}$, ($r > 0$), $= 6\{\Gamma(r)\}^4/\Gamma(4r)$.

13. Show that if $r > 0$ and x_1, x_2, \dots, x_n be all positive and subject to the condition $x_1 + x_2 + \dots + x_n = 1$, then

$$M\{(x_1 x_2 \dots x_n)^{r-1}\} = \Gamma(n)\{\Gamma(r)\}^n/\Gamma(nr).$$

14. Show that if t_1, t_2, \dots, t_n be all positive, the mean value of $x_1^{t_1-1}x_2^{t_2-1} \dots x_n^{t_n-1}$ for positive values of x_1, x_2, \dots, x_n subject to the condition $\sum_1^n x_r = 1$ is $\Gamma(n)\Gamma(t_1)\Gamma(t_2) \dots \Gamma(t_n)/\Gamma(\sum_1^n t_r)$.

15. Show that the mean value of $Ayz + Bxz + Cxy$ for positive values of x, y, z subject to the condition $x + y + z = 1$ is $\frac{1}{3}(A + B + C)$.

16. Show that the mean value $x^4 + y^4 + z^4$ for positive values of x, y, z subject to the condition $x + y + z = 1$ is $\frac{1}{5}$.

17. Show that the mean value of $(A, B, C, D, E, F)(x, y, z)^2$ for positive values of x, y, z subject to the areal condition $x + y + z = 1$ is

$$\frac{1}{6}(A + B + C + D + E + F).$$

18. Let there be n points upon the x -axis, and let positive ordinates of increasing magnitude be erected at these points, their sum being l . Find the mean length of the r^{th} ordinate. [LAPLACE; TODHUNTER, *Hist.*, p. 545.]

Taking as ordinates $y_1, y_1 + y_2, y_1 + y_2 + y_3, \dots, y_1 + \dots + y_n$, then

$$ny_1 + (n-1)y_2 + (n-2)y_3 + \dots + y_n = l.$$

Putting $ny_1 = x_1, (n-1)y_2 = x_2, \dots, y_n = x_n$, we have $x_1 + x_2 + \dots + x_n = l$.

We then require
$$\frac{\iiint \dots \int \left(\frac{x_1}{n} + \frac{x_2}{n-1} + \dots + \frac{x_r}{n-r+1} \right) dx_1 dx_2 \dots dx_{n-1}}{\iiint \dots \int dx_1 dx_2 \dots dx_{n-1}},$$

which gives
$$\frac{l}{n} \left\{ \frac{1}{n} + \frac{1}{n-1} + \frac{1}{n-2} + \dots + \frac{1}{n-r+1} \right\}.$$

19. The density at any point of a triangular lamina varies as the product of the perpendiculars on the sides. Show that the mean density is $9/20$ of the density at the centre of inertia of the triangle.

1664. Certain Inequalities.

If a, b, c, \dots be any positive quantities, n in number, and $m, r, \alpha, \beta, \dots$ positive integers and $a + \beta + \dots = m$ and $m > r$, we have

$$\begin{aligned} \text{(i)} \quad \frac{\sum a^2}{n} &> \left(\frac{\sum a}{n}\right)^2; & \text{(ii)} \quad \frac{\sum a^m}{n} &> \frac{\sum a^r}{n} \cdot \frac{\sum a^{m-r}}{n}; \\ \text{(iii)} \quad \frac{\sum a^m}{n} &> \frac{\sum a^\alpha}{n} \cdot \frac{\sum a^\beta}{n} \cdot \frac{\sum a^\gamma}{n} \dots \quad (\text{Smith, Alg., Art. 348.}) \end{aligned}$$

That is, the mean of the squares $>$ the square of the mean; the mean of the m^{th} powers $>$ the product of the means of the r^{th} and $(m-r)^{\text{th}}$ powers; and so on.

1665. If a, b, c, \dots be replaced by $\phi(a_0), \phi(a_0+h), \phi(a_0+2h), \dots$, the values of a positive continuous single-valued function of x for equal infinitesimal increments of the variable, we have the mean value of the square of the function $>$ the square of the mean value of the function between the same limits, with other theorems of a similar nature. That is,

$$\begin{aligned} \frac{\int_p^q [\phi(x)]^2 dx}{\int_p^q dx} &> \left[\frac{\int_p^q \phi(x) dx}{\int_p^q dx} \right]^2; \\ \frac{\int_p^q [\phi(x)]^m dx}{\int_p^q dx} &> \frac{\int_p^q [\phi(x)]^r dx}{\int_p^q dx} \cdot \frac{\int_p^q [\phi(x)]^{m-r} dx}{\int_p^q dx}; \text{ etc.} \end{aligned}$$

1666. General Mean in Terms of Means restricted in Various Ways.

Let there be two regions Ω_1 and Ω_2 mutually exclusive. Let two random points P and Q be taken in the combined region, and let ϕ be some function of their positions, say for instance their distance apart, its square or its n^{th} power. Several cases may occur: (i) Both may lie in Ω_1 ; (ii) both may lie in Ω_2 ; (iii) and (iv) either may lie in Ω_1 and the other in Ω_2 .

Let $M_{1,1}$, $M_{2,2}$, $M_{1,2}$ be the mean values of ϕ respectively in case (i), case (ii), cases (iii) and (iv), and let M be the mean value of ϕ when the positions of P and Q are unrestricted. The number of cases occurring are measured by the magnitudes of the regions, viz. Ω_1^2 if both lie in Ω_1 , Ω_2^2 if both lie in Ω_2 , $\Omega_1\Omega_2$ if P lies in Ω_1 and Q in Ω_2 , and $\Omega_1\Omega_2$ if Q lies in Ω_1 and P in Ω_2 , and $(\Omega_1 + \Omega_2)^2$ if they lie in either region, unspecified.

Hence $\Omega_1^2 M_{1,1}$, $\Omega_2^2 M_{2,2}$, $2\Omega_1\Omega_2 M_{1,2}$ and $(\Omega_1 + \Omega_2)^2 M$ are the sums of the several cases occurring. But the first three must make up the whole sum of the possible values of ϕ , *i.e.*

$$M = \frac{\Omega_1^2 M_{1,1} + 2\Omega_1\Omega_2 M_{1,2} + \Omega_2^2 M_{2,2}}{(\Omega_1 + \Omega_2)^2}.$$

1667. Ex. If the two regions be mutually exclusive spheres of radii a and b and centres distance c apart, then for the mean distance $P'Q$,

$$M_{1,1} = \frac{36a}{35}, \quad M_{2,2} = \frac{36b}{35}, \quad M_{1,2} = c + \frac{a^2 + b^2}{5c}.$$

Hence the mean distance between P and Q when each may lie within either sphere or in different spheres is

$$\begin{aligned} & \left[\left(\frac{4}{3} \pi a^3 \right) \frac{36}{35} a + 2 \cdot \frac{4}{3} \pi a^3 \cdot \frac{4}{3} \pi b^3 \left(c + \frac{a^2 + b^2}{5c} \right) + \left(\frac{4}{3} \pi b^3 \right) \frac{36}{35} b \right] / \left(\frac{4}{3} \pi a^3 + \frac{4}{3} \pi b^3 \right) \\ & = \frac{36}{35} \frac{a^7 + b^7}{(a^3 + b^3)^2} + 2 \frac{a^3 b^3}{(a^3 + b^3)^2} c + \frac{2}{5} \frac{a^3 b^3 (a^2 + b^2)}{(a^3 + b^3)^2} \cdot \frac{1}{c}. \end{aligned}$$

In the case where the spheres are equal and in contact, $c = 2a = 2b$ and $M = \frac{13}{10} a$.

1668. In the same way, if there be three or more mutually exclusive regions $\Omega_1, \Omega_2, \Omega_3$, say, and ϕ be a function of the positions of three points P, Q, R which lie in one or other of these regions, then (a) all may lie in any one of the regions, (b) two may lie in one region, and one in either of the other regions, or (c) one may lie in each region.

Let $M_{3,0,0}$ be the mean value of ϕ when all lie in Ω_1 , $M_{0,3,0}$ when all lie in Ω_2 , $M_{2,1,0}$ when two lie in Ω_1 and one in Ω_2 , and so on; and let M be the mean irrespective of where they lie. The respective numbers of cases are measured by $\Omega_1^3, \Omega_2^3, 3\Omega_1^2\Omega_2$, etc., and $(\Omega_1 + \Omega_2 + \Omega_3)^3$, and the sums of these cases are respectively measured by

$$\Omega_1^3 M_{3,0,0}, \quad \Omega_2^3 M_{0,3,0}, \quad 3\Omega_1^2\Omega_2 M_{2,1,0}, \quad \text{etc., and } (\Omega_1 + \Omega_2 + \Omega_3)^3 M,$$

and the last, being the sum of all possible values of ϕ , is equal to the sum of all the several cases previously enumerated. Hence

$$M = \frac{\Sigma \Omega_1^3 M_{3,0,0} + 3 \Sigma \Omega_1^2 \Omega_2 M_{2,1,0} + 6 \Omega_1 \Omega_2 \Omega_3 M_{1,1,1}}{(\Omega_1 + \Omega_2 + \Omega_3)^3},$$

and so on if there be more than three mutually exclusive regions.

1669. **Regions not mutually exclusive.**

To go back to the case of two regions, suppose next that the regions Ω_1 and Ω_2 have a common region Ω . The whole region bounded is then $\Omega_1 + \Omega_2 - \Omega$.

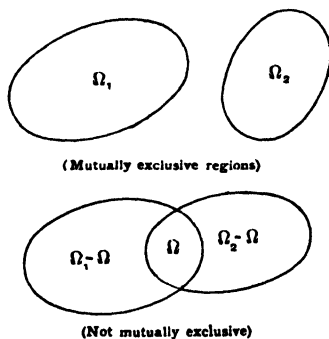

Fig. 515.

Let $M_{\Omega_1 + \Omega_2 - \Omega}$ be the mean value of ϕ , when the random points P, Q lie anywhere in the whole region; $M_{\Omega_1 - \Omega}$ the mean when both lie in $\Omega_1 - \Omega$; $M_{\Omega_2 - \Omega}$ the mean when both lie in $\Omega_2 - \Omega$; M the mean when one lies in Ω_1 and one in Ω_2 .

The respective numbers of cases are $(\Omega_1 + \Omega_2 - \Omega)^2$, $(\Omega_1 - \Omega)^2$, $(\Omega_2 - \Omega)^2$ and $2\Omega_1\Omega_2 - \Omega^2$; for in allowing P and Q each to range over Ω_1 and Ω_2 respectively, or Ω_2 and Ω_1 respectively, the region Ω is counted twice over.

The sum of the values of ϕ when one lies in Ω_1 and one in Ω_2 is $(2\Omega_1\Omega_2 - \Omega^2)M$.

The sum when both lie in $\Omega_1 - \Omega$ is $(\Omega_1 - \Omega)^2 M_{\Omega_1 - \Omega}$.

The sum when both lie in $\Omega_2 - \Omega$ is $(\Omega_2 - \Omega)^2 M_{\Omega_2 - \Omega}$,

and the three make up the total sum $(\Omega_1 + \Omega_2 - \Omega)^2 M_{\Omega_1 + \Omega_2 - \Omega}$;

$$\therefore M_{\Omega_1 + \Omega_2 - \Omega} = \frac{(\Omega_1 - \Omega)^2 M_{\Omega_1 - \Omega} + (\Omega_2 - \Omega)^2 M_{\Omega_2 - \Omega} + (2\Omega_1\Omega_2 - \Omega^2)M}{(\Omega_1 + \Omega_2 - \Omega)^2}.$$

1670. Similarly more complex cases may be examined. Also the present formulæ admit of considerable reduction for special cases, e.g. when the regions are equal or when one region is enclosed completely by the other.

1671. **The Geometric Mean. Clerk Maxwell. An Integral useful in Electromagnetic Problems.**

If $\log R_{AB}$ be the mean value of the logarithm of the distance between points P and Q , one in each of the areas A and B lying in the same plane, then obviously

$$\log R_{AB} = \frac{\iint \log PQ \cdot dA \, dB}{\iint dA \, dB},$$

the integrations being conducted for all elements of area in A , and for all elements of area in B .

The integration $\iiint \log r \, dx \, dy \, dx' \, dy'$, over two such areas occurs in the determination of the electromagnetic action between two parallel straight currents flowing in conductors of given sections. (Clerk Maxwell, *E. and M.*, ii., p. 294).

Clearly $A \cdot B \cdot \log R_{AB} = \iint \log PQ \cdot dA \, dB$.

If C be a third area in the same plane, in which P or Q could lie, $(A+B)C \log R_{(A+B)C}$ represents on some scale the sum of the logarithms of the distances of points in C , from points in the composite area $A+B$, whilst $AC \log R_{AC}$ represents on the same scale the sum of those cases of the aforesaid group which refer to lines joining points in A with points in C ; and similarly with $BC \log R_{BC}$. Hence

$$(A+B)C \log R_{(A+B)C} = AC \log R_{AC} + BC \log R_{BC}.$$

And this rule may be extended. Thus, if there be a fourth area D in the same plane,

$$\begin{aligned} (A+B+C)D \log R_{(A+B+C)D} &= (A+B)D \log R_{(A+B)D} + CD \log R_{CD} \\ &= AD \log R_{AD} + BD \log R_{BD} + CD \log R_{CD}; \end{aligned}$$

and so on.

Thus, if R be found for pairs of parts of a composite figure the rule will give R for the whole figure.

Also A, B, C, \dots are not necessarily different figures.

Maxwell states the results for a number of cases. He calls the line R thus determined the Geometric mean of all the distances between such pairs of points.

1672. Cases of Maxwell's Geometric Mean.

I. To find R for a point C , and a finite straight line AB . (Fig. 516.)

Let CO be drawn at right angles to the direction of AB .

P a point on AB , $OA = a = x_1$, $OB = b = x_2$, $OC = p$, $OP = x$, $CP = r$, $AB = l = b - a$. $CA = r_1$, $CB = r_2$.

$$\text{Then } l \log R = \int_a^b \log \sqrt{x^2 + p^2} dx = \left[x \log \sqrt{x^2 + p^2} - x + p \tan^{-1} \frac{x}{p} \right]_a^b;$$

$$\therefore l(\log R + 1) = OB \log CB - OA \log CA + OC \times \text{circ. meas. of } \hat{ACB},$$

i.e. $(x_2 - x_1)(\log R + 1) = x_2 \log r_2 - x_1 \log r_1 + p \cdot \hat{r}_1 r_2.$

In the case when C lies on AB produced, $p = 0$, and

$$\log R + 1 = (x_2 \log x_2 - x_1 \log x_1) / (x_2 - x_1).$$

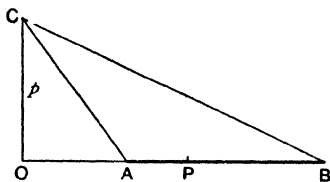

Fig. 516.

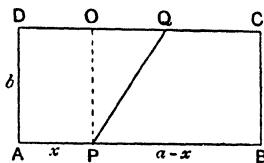

Fig. 517.

1673. II. Let $ABCD$ be a rectangle, $AB = a$, $AD = b$. Let P and Q be points respectively upon AB and CD . PO the perpendicular upon CD . $AP = x$. (Fig. 517.)

For a given point P let R_1 refer to the value of R for the fixed point P ,

$$\begin{aligned} a(\log R_1 + 1) &= OD \log PD + OC \log PC + b \hat{CPD} \\ &= x \log \sqrt{x^2 + b^2} + (a - x) \log \sqrt{(a - x)^2 + b^2} + b \left(\tan^{-1} \frac{x}{b} + \tan^{-1} \frac{a - x}{b} \right). \end{aligned}$$

Integrating with regard to x from 0 to a ,

$$\begin{aligned} a^2(\log R + 1) &= \left[\frac{x^2 + b^2}{2} \log \sqrt{x^2 + b^2} - \frac{x^2 + b^2}{4} \right]_0^a - \left[\frac{(a - x)^2 + b^2}{2} \log \sqrt{(a - x)^2 + b^2} - \frac{(a - x)^2 + b^2}{4} \right]_0^a \\ &+ b \left[x \tan^{-1} \frac{x}{b} - b \log \sqrt{x^2 + b^2} \right]_0^a - b \left[(a - x) \tan^{-1} \frac{a - x}{b} - b \log \sqrt{(a - x)^2 + b^2} \right]_0^a, \end{aligned}$$

i.e. $a^2(\log R + \frac{3}{2}) = (a^2 - b^2) \log D + b^2 \log b + 2ab \tan^{-1} \frac{a}{b},$

where D is the diagonal.

1674. III. If P lies upon AB and Q upon AD , and R_1 as before refers to the result for a fixed point P ,

$b(\log R_1 + 1) = b \log \sqrt{x^2 + b^2} + x \tan^{-1} \frac{b}{x}$; and integrating from 0 to a ,

$$ab(\log R + 1) = b \left[x \log \sqrt{x^2 + b^2} - x + b \tan^{-1} \frac{x}{b} \right]_0^a + \left[\frac{x^2 + b^2}{2} \tan^{-1} \frac{b}{x} + \frac{1}{2} bx \right]_0^a;$$

$$\therefore ab(\log R + \frac{3}{2}) = ab \log D + \frac{a^2}{2} \tan^{-1} \frac{b}{a} + \frac{b^2}{2} \tan^{-1} \frac{a}{b}.$$

1675. IV. If Q lies on the circumference of a circle of radius a , and centre O , and P be any point in its plane distant c from the centre,

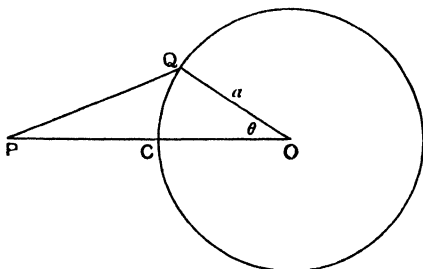

Fig. 518.

$$\begin{aligned} 2\pi a \log R &= 2 \int_0^\pi \log \sqrt{a^2 - 2ac \cos \theta + c^2} \cdot a \, d\theta \\ &= 2\pi a \log a, \quad (c < a); \text{ or } 2\pi a \log c, \quad (c > a). \end{aligned}$$

Therefore R = the greater of the two a or c ; and the mean of $\log r$ is accordingly

$$\log a, \quad (c < a), \quad \text{or} \quad \log c, \quad (c > a).$$

1676. V. If P travels on the circumference of a second circle of radius b entirely without the former, the distance of the centres being d , and if $\log R$ stand for the mean value of $\log PQ$,

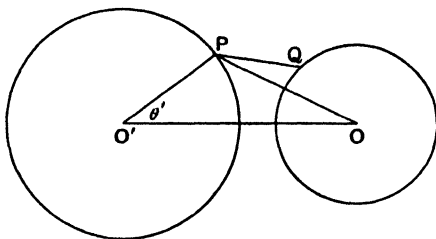

Fig. 519.

$$\begin{aligned} 2\pi b \cdot 2\pi a \log R &= 2\pi a \cdot 2 \int_0^\pi \log PO \cdot b \, d\theta' \\ &= 2\pi a \cdot 2 \int_0^\pi \log \sqrt{b^2 - 2bd \cos \theta' + d^2} \, b \, d\theta' \\ &= 2\pi a \cdot 2\pi b \log d; \quad \therefore R = d. \end{aligned}$$

Similarly if one circle be entirely within the other.

1677. VI. If Q lies upon a circular annulus, centre O , external and internal radii a_1 and a_2 , and P be at a point distant c from O , and $\log R = M(\log PQ)$, $QO = r$, $\widehat{QOP} = \theta$,

$$\begin{aligned} \pi(a_1^2 - a_2^2) \log R &= 2 \int_{a_1}^{a_2} \int_0^\pi \log \sqrt{c^2 - 2cr \cos \theta + r^2} \cdot r d\theta dr \\ &= 2 \int_{a_2}^{a_1} \pi \log c \cdot r dr, (c > r); \text{ or } = 2 \int_{a_2}^{a_1} \pi \log r \cdot r dr, (c < r), \\ &= \pi \log c \cdot (a_1^2 - a_2^2) \text{ if } c > a_1, \\ \text{or} \quad &= \pi \left[r^2 \log r - \frac{r^2}{2} \right]_{a_1}^{a_2} = \pi \left(a_1^2 \log a_1 - a_2^2 \log a_2 - \frac{a_1^2 - a_2^2}{2} \right) \text{ if } c < a_2, \\ \text{i.e.} \quad &\text{if } c > a_1, \log R = \log c; \dots\dots\dots(\alpha) \\ &\text{if } c < a_2, \log R = \frac{a_1^2 \log a_1 - a_2^2 \log a_2}{a_1^2 - a_2^2} - \frac{1}{2}. \dots\dots\dots(\beta) \end{aligned}$$

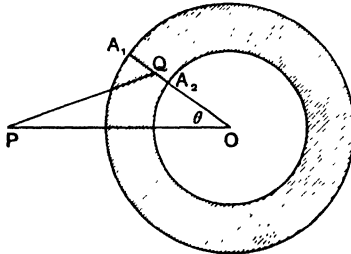

Fig. 520.

If $a_1 > c > a_2$, and P itself lies upon the annulus,

$$\pi(a_1^2 - a_2^2) \log R = \int_{a_2}^c 2\pi \log c \cdot r dr + \int_c^{a_1} 2\pi \log r \cdot r dr;$$

$$\text{whence } \log R = \frac{c^2 - a_2^2}{a_1^2 - a_2^2} \log c + \frac{a_1^2 \log a_1 - c^2 \log c}{a_1^2 - a_2^2} - \frac{1}{2} \frac{a_1^2 - c^2}{a_1^2 - a_2^2} \dots\dots\dots(\gamma)$$

Since $R = c$ when P is without the annulus, the mean value of $\log PQ$, where P lies upon any region entirely without the annulus is the mean value of $\log PO$. And if P lies upon any region entirely within the annulus, the expression for R , in that case not containing c , is independent of the shape or position of the region.

We may deduce the result (γ) from (α) and (β) by Art. 1671. Let A and B be the regions of the annulus respectively outside and inside a concentric circle through Q . Then if C be an elementary small area in which P lies,

$$(A + B) \log R_{(A+B)C} = A \log R_{AC} + B \log R_{BC};$$

$$\pi(a_1^2 - a_2^2) \log R_{(A+B)C} = \pi(a_1^2 - c^2) \left\{ \frac{a_1^2 \log a_1 - c^2 \log c}{a_1^2 - c^2} - \frac{1}{2} \right\} + \pi(c^2 - a_2^2) \log c,$$

giving the same result as before.

1678. VII. If P be not at a fixed point within the annulus, but may travel anywhere within it,

$$\{\pi(a_1^2 - a_2^2)\}^2 \log R = \iiint \log \sqrt{r_1^2 - 2r_1r_2 \cos(\theta_1 - \theta_2) + r_2^2} \cdot r_1 d\theta_1 dr_1 r_2 d\theta_2 dr_2,$$

where r_1 , θ_1 and r_2 , θ_2 are the polar coordinates of P and Q .

The limits for θ_1 are θ_2 to $\theta_2 + 2\pi$; for θ_2 , 0 to π , and double the result;
for r_2 from a_2 to r_1 and r_1 to a_1 ; for r_1 , from a_2 to a_1 .

The first integration gives

$$2(\pi \log r_1) r_1 r_2 dr_1 dr_2 d\theta_2 \quad \text{or} \quad 2(\pi \log r_2) r_1 r_2 dr_1 dr_2 d\theta_2,$$

according as r_1 or r_2 is the greater.

The second merely multiplies the result by 2π .

The third gives

$$4\pi^2 \int_{a_2}^{r_1} r_1 r_2 \log r_1 dr_1 dr_2 + 4\pi^2 \int_{r_1}^{a_1} r_1 r_2 \log r_2 dr_1 dr_2 \\ = 2\pi^2 [a_1^3 \log a_1 \cdot r_1 - a_2^3 r_1 \log r_1 - \frac{1}{2}(a_1^2 r_1 - r_1^3)] dr_1.$$

The final integration gives, after dividing by $\pi^2(a_1^2 - a_2^2)^2$,

$$\log R = \log a_1 - \frac{a_2^4}{(a_1^2 - a_2^2)^2} \log \frac{a_1}{a_2} + \frac{3a_2^2 - a_1^2}{4(a_1^2 - a_2^2)}, \text{ a result stated by Maxwell.}$$

For the mean of the logarithms for pairs of points within any circular area, put $a_2 = 0$; then $\log R = \log a_1 - \frac{1}{4}$, that is $R = a_1 e^{-\frac{1}{4}}$ or R is a little more than $3a/4$.

Other results of similar character are stated by Maxwell with a reference to *Trans. R.S., Edinb.*, 1871-2.

1679. Other cases of mean values will be considered in the next chapter, which are more intimately connected with the general Theory of Probability.

PROBLEMS.

1. If the sides of a rectangle may have any values between a and b , prove that the mean area $= (a + b)^2/4$. [R. P.]

2. Find the average area of a random sector whose vertex is taken at a given point on a given circle.

3. $ABCD$ is a square. Show that the average distance of A from points on BC for an equable distribution of radii vectores about A is $\frac{4AB}{\pi} \log \frac{AC + AB}{AB}$; but for an equable distribution of points on BC it is $\frac{AC}{2} + \frac{AB}{2} \log \frac{AC + AB}{AB}$.

4. A rod of length a is broken into two parts at random. Show that the mean value of the sum of the squares of the parts $= 2a^2/3$.

[Ox. II., 1886.]

5. A rod of length a is broken into two parts at random. Show that the mean value of the rectangle contained by the parts is $a^2/6$.

6. The sum of two positive numbers is given $= N$. Show that the mean value of the product of the p^{th} power of the one and the q^{th} power of the other is $p!q!N^{p+q}/(p+q+1)!$, p and q being positive integers.

7. Find the mean value of the (i) squares, (ii) cubes of all radii vectores of a cardioide for an equable angular distribution of radii vectores about the pole.

8. Given the base and the radius of the circumcircle of a triangle, determine its mean area, stating clearly what assumptions you make as to equal probability. [ST. JOHN'S, 1884.]

9. Show that the average of the squares of the distances of all points within a given circle from a point on the circumference is three times that of the squares of all points within the circle from the centre. [COLLEGES, 1878.]

10. Find the mean value of the squares of the distances of all points within a rectangle (i) from the centre of the rectangle, (ii) from any point in the plane of the rectangle, (iii) from any point not in the plane of the rectangle.

11. Find the mean value of the focal radii vectores of a cardioide (i) for an equable angular distribution of radii, (ii) for an equable arcual distribution.

12. If a solid be formed by the revolution of a cardioide about its axis, find the mean value of the focal distances of points on the surface of the solid (i) for an equable surface distribution, (ii) for an equable solid angle distribution.

13. Find the mean value of the squares of the distances between any two points within a given (i) triangle, (ii) square, (iii) sphere, (iv) cube.

14. (i) Find the mean of the inverse distances of points within an ellipse from a focus for an equable areal distribution.

(ii) Find the mean of the inverse distances of points within a prolate spheroid from a focus for an equable volume distribution.

15. Show that the mean distance of points within a sphere of radius a from points of the surface of a shell of double the radius of the sphere is $21a/10$, and that the mean distance of points on the surface of the sphere from points on the shell is $13a/6$.

16. Show that the mean distance of all points within a sphere of radius a from a point midway between the centre and the surface is $279a/320$.

17. Show that the mean distance of a point on the external surface of a spherical shell of thickness T from points in the material of the shell is $\frac{6}{5}R + \frac{1}{5}\frac{(R-T)^3(2R-T)}{R(3R^2-3RT+T^2)}$, where R is the external radius.

18. Show that the mean distance between points P and Q , of which P lies within a sphere of radius R and Q lies between this sphere and a concentric sphere of double the radius, is $3^5R/140$.

19. There are two concentric spherical shells, the bounding surfaces of which are 1 inch, 2 inches, 3 inches, and 4 inches. Show that the average distance of points in the material of the first from points in the material of the second is $3\frac{5}{7}\frac{9}{16}$ inches.

20. Two equal spherical surfaces are in contact. Show that the mean distance of points on the one surface from points on the other = $7/3$ of the radius of either.

Show further that if the points may lie anywhere within their respective spheres, their mean distance is $11/5$ of the radius of either; but that if one of the points lies within one of the spheres and the other point on the surface of the other sphere, their mean distance is $34/15$ of the radius.

21. If M_n be the mean of the n^{th} power of the distance between two points on the area bounded by a circle of diameter unity, show that

$$M_{n+2} = M_n(n+2)(n+3)/(n+4)(n+6).$$

22. If M_n be the mean of the n^{th} power of the distance between two points on the surface of a sphere of unit diameter, show that

$$M_{n+1} = M_n(n+2)/(n+3).$$

23. If M_n be the mean of the n^{th} power of the distance between two points within a sphere of diameter unity, show that

$$M_{n+1} = M_n(n+3)(n+6)/(n+5)(n+7)$$

24. A point O is taken outside a sphere with centre C and radius a . $CO = 2a$. Show that the mean of the cubes of the distances of O from points within the sphere = $731a^3/70$, and that the mean of the fourth powers = $171a^4/7$.

25. Show that the mean value of $x^4y^4z^4$ over the surface of a sphere of radius a is $a^{12}/5005$.

26. Show that the mean value of $x^{p-1}y^{q-1}z^{r-1}$ for positive values of x, y, z , subject to the condition $a^{-2}x^2 + b^{-2}y^2 + c^{-2}z^2 = 1$ for an equable distribution of areas on the $x-y$ plane, is

$$a^{p-1}b^{q-1}c^{r-1} \Gamma\left(\frac{p}{2}\right) \Gamma\left(\frac{q}{2}\right) \Gamma\left(\frac{r+1}{2}\right) / \pi \Gamma\left(\frac{p+q+r+1}{2}\right),$$

where p, q, r are all greater than unity.

27. On a straight line of unit length two random points are taken. Show that the mean of the square of the distance between them is $1/6$ of a unit of area.

28. Circles are inscribed in the triangles formed by joining points on an ellipse of semi-axes a, b and eccentricity e to the foci. Show that the mean value of the areas of the circles for equal increments of a focal vectorial angle is

$$\pi a^2(1-e)^2(a/b-1). \quad [\text{MATH. TRIP., 1892.}]$$

29. Show that the mean value of the product of the three perpendiculars from any point within a triangle upon the sides is $p_1 p_2 p_3 / 60$, where p_1, p_2, p_3 are the perpendiculars from the angular points upon the opposite sides.

30. Show that the mean value of the product of the four perpendiculars from any point within a tetrahedron upon the faces is $p_1 p_2 p_3 p_4 / 560$, where p_1, p_2, p_3, p_4 are the perpendiculars from the several quoin upon the opposite faces.

31. Five points, A, B, C, D, E , are taken upon a straight line AE , to which perpendiculars are drawn through these points of increasing magnitude. The sum of these five perpendiculars is 10 inches. Show that the mean length of the middle perpendicular is $47/30$ of an inch.

32. Show that the mean distance of all points within a given regular polygon of side $2a$ from the centre is $\frac{R}{3} + \frac{1}{3} \frac{r^2}{a} \log \frac{R+a}{r}$, where R and r are the radii of the circumscribed and inscribed circles.

33. Show that the rectangle contained between the average value of the radius of curvature at points equally distributed along a curve and the corresponding arc is double the area contained between the curve, the evolute and the normals at the extremities of the arc.

[3, 1883.]

34. Prove that the mean value of the radius of curvature at points equally distributed along the cardioide $r = a(1 + \cos \theta)$ is $a\pi/3$, while the density distribution of the corresponding points along the pedal with respect to the pole varies at any point as the curvature at the corresponding point of the cardioide. [δ, 1883.]

35. Prove that the square of the mean value of any function of a variable between any limits of the variable is less than the mean value of the square of that function between the same limits of the variable. [ST. JOHN'S, 1883.]

36. Find the mean value of the squares of the distances from a focus of all points within an ellipse whose eccentricity is $\sqrt{3}/2$. [δ, 1881.]

37. The circumference of the auxiliary circle of an ellipse, whose axes are $ACA' = 2a$, $BCB' = 2b$, is divided at Q_1, Q_2, \dots into a large number of equal arcs. At P_1 , the point on the ellipse whose eccentric angle is ACQ_1 , a circle is described so as to touch the ellipse at P_1 and to have its centre on the major axis. Show that the mean area of all such circles is $\pi b^2(a^2 + b^2)/2a^2$. [α, 1881.]

38. At any point P of a catenary whose parameter is c , the ordinate PN and the normal PG are drawn to meet the directrix at N and G respectively. Prove that the mean values of the area of the triangle NPG for points proceeding by equal increments of (i) abscissa, (ii) ordinate, (iii) arc, up to a point whose coordinates are (x, y) , are respectively

$$(i) (y^3 - c^3)/6x; \quad (ii) c^2 \left(c \sinh \frac{4x}{c} - 4x \right) / 64(y - c); \quad (iii) (y^4 - c^4)/8cs.$$

39. Find the mean of the inverse distances of two random points, one on the surface of a sphere, the other on a circular area exterior to the sphere and whose plane is at right angles to the line of centres.

40. Prove that the mean of the inverse distance between points on the surface of a sphere and points on a straight rod of length l , external to the sphere, which is bisected at right angles by a perpendicular upon it from the centre of the sphere, is $\frac{2}{l} \log \tan \frac{\pi + \alpha}{4}$, where α is the angle at the centre of the sphere subtended by the rod.

41. Prove that the mean inverse distance between points on the surface of a sphere of radius a and points on a concentric ring of radius b is b^{-1} if $b > a$ or a^{-1} if $b < a$.

42. Prove that the mean value of x for all points within the positive octant of the surface $(x/a)^{\frac{2}{3}} + (y/b)^{\frac{2}{3}} + (z/c)^{\frac{2}{3}} = 1$ is $21a/128$.

43. On a given finite arc n points are drawn dividing it into equal small lengths, and n other points are taken, parallels to the normals at which divide the angle between the extreme normals into equal small angles. Prove that when n is indefinitely increased the mean of the radii of curvature at the former n points is greater than the mean of the radii of curvature at the latter n points, the curvature being supposed finite at every point of the arc. [ST. JOHN'S, 1889.]

44. If $\log R$ be the mean value of the logarithm of the distance between two points P and Q which lie on a line AB of length a , show that $R = ae^{-\frac{3}{2}}$. [CLERK MAXWELL, *El. and Mag.*, II., p. 296.]

CHAPTER XXXVII.

CHANCE.

1680. DEF. If an event can happen in a ways and fail in b ways, and all these ways are *equally likely* to occur, the probability of the happening is $a/(a+b)$ and of the failure to happen is $b/(a+b)$.

These measures are essentially numerical positive proper fractions. Certainty is denoted by unity. A mean value is essentially a quantity of the same kind as those of which the mean is taken. So long as a and b are finite, the theory of probability does not call for any mode of treatment other than the processes of ordinary arithmetic and algebra. If, however, a problem incurs the existence of an infinite number of ways in which an event could happen and an infinite number of ways in which it could fail to happen, all these being equally likely, the calculation of a , b and $a+b$ may call for the processes of the Integral Calculus, or at least the fundamental conceptions of the Calculus, to effect the necessary summations, though sometimes in such cases the actual labour of integration may be avoided by geometrical or other considerations.

1681. Take, for instance, the case of a material particle thrown down upon a region of area A , and which is *equally likely to fall at any point of the area*; and let us explain this phrase. Imagine the area A to be divided up into an infinite number of infinitesimally small elements of equal area, and suppose that an infinite number of trials is made. We shall also suppose that, after these trials, the particle has fallen as many times upon any one element as upon any other. Then if a be any region of finite area enclosed completely within

the contour of A , a and A contain numbers of the infinitesimal elements of area proportional to and measured by their own areas. Hence the numbers of particles which have fallen respectively upon a and upon A are measured by the respective areas of a and A , and the chance that a particle which falls upon A also falls upon a is $\frac{a}{A}$, and that it does not so fall is $1 - \frac{a}{A}$.

The chance that of two hazard throws of a particle upon A both fall upon a is $\frac{a}{A} \cdot \frac{a}{A}$. That the first does and the second does not, the chance is $\frac{a}{A} \left(1 - \frac{a}{A}\right)$. That the first does not and the second does is $\left(1 - \frac{a}{A}\right) \frac{a}{A}$; and that neither does is $\left(1 - \frac{a}{A}\right) \left(1 - \frac{a}{A}\right)$, and the sum of these is unity. And so on if there be more than two throws.

It will appear that in such cases, unless the areas be known or obtainable by some elementary means, either the Integral Calculus or some equivalent graphical method will be necessary for their evaluation. Taking any pair of rectangular axes in the plane of the region A , the chance that the throw upon A results in the particle falling upon a may be expressed as

$$\iint dx dy \text{ (taken over } a) / \iint dx dy \text{ (taken over } A).$$

1682. We note that the chance that a particle should fall upon the *perimeter* of the contour of a is infinitesimal in comparison with the chance that it should fall upon the *area* of a .

1683. We indicate by a few examples how the Integral Calculus is to be *applied* in some cases, and how the actual integration may be *evaded* in others.

1. $OA = 2a$ is the axis of a cardioid. C is the mid-point of OA . What is the chance that a random point P taken within the cardioid is further from C than C is from O ?

Drawing a circle with centre C and radius CO , P must lie without the circle but within the cardioid. The area of the cardioid

$$= 2 \cdot \frac{1}{2} \int_0^\pi a^2 (1 + \cos \theta)^2 d\theta = \frac{3}{2} \pi a^2.$$

Therefore the chance required is $\left(\frac{3}{2} \pi a^2 - \pi a^2\right) / \frac{3}{2} \pi a^2 = \frac{1}{3}$.

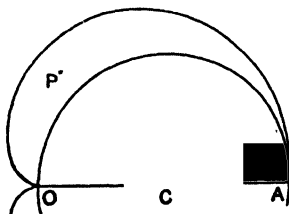

Fig. 521.

2. Given that p, q are any positive quantities of which neither is > 4 ; what is the probability that when real values are assigned to them at random, the roots of the quadratic $x^2 - px + q = 0$ shall be real?

If real, $p^2 \leq 4q$. Construct the parabola $Y^2 = 4X$. The point $(4, 4)$ lies upon it. We may then interpret the condition geometrically. A random point H is selected upon a square $ONPQ$, whose side is 4. The above parabola is drawn with axes ON, OQ . The values of p and q are denoted by the abscissa and ordinate of H . When H lies without the parabola $p^2 > 4q$. Therefore the chance that $p^2 \leq 4q$ is measured by the ratio of the area OPQ to that of the square; that is, $1/3$. (Fig. 522.)

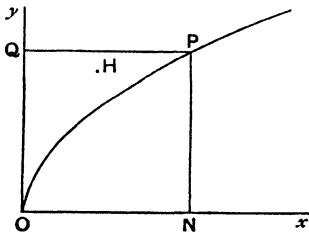

Fig. 522.

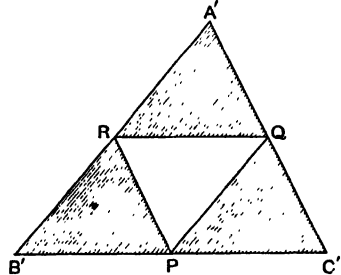

Fig. 523.

3. A rod, three feet long, is broken at random into three parts. What is the chance that we may be able to form a triangle with them?

(i) If x, y, z be the parts, $x + y + z = 1$, the unit being a yard. We are to have $y + z > x$, $z + x > y$, $x + y > z$. Interpreting x, y, z as areal coordinates, then $y + z = x$, etc.,

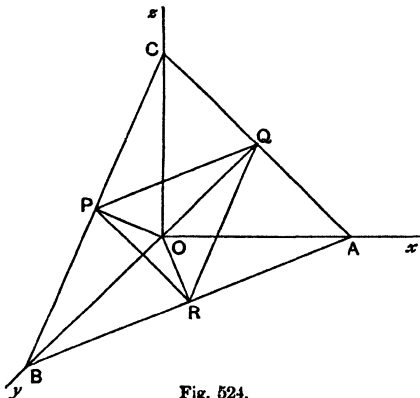

Fig. 524.

are the joins of the mid-points of the sides of the triangle of reference. In order that all the inequalities may be satisfied, the representative point x, y, z must lie within the triangle formed by them (unshaded, Fig. 523), which is one quarter of the whole triangle. Hence the chance is $\frac{1}{4}$.

(ii) We might also regard x, y, z as the rectangular coordinates of a representative point. Taking 1 foot as unit, $x + y + z = 3$; and this

is the equation of a plane making intercepts 3, 3, 3 upon the coordinate axes. If A, B, C be the intercepted triangle; P, Q, R the mid-points of

its sides, $y+z=x$, etc., are the respective planes OQR , etc., and of all the unrestricted positions upon the triangle which the representative point x, y, z may occupy those for which $y+z > x$, etc., lie within the triangle PQR . Therefore, as before, the chance = $\frac{1}{4}$.

(iii) Again, without evasion of integration, we may proceed thus :

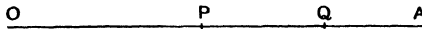

Fig. 525.

Let $OA (=a)$ be the rod, P and Q the random fractures, P being that which is nearer to O ; $OP=x, OQ=y; y > x$.

Then, since

$$x + (y - x) > (a - y), \quad (y - x) + (a - y) > x, \quad \text{and} \quad (a - y) + x > (y - x),$$

we have $x < \frac{a}{2}, y > \frac{a}{2}, y - x < \frac{a}{2}$. Hence the chance required is

$$\int_0^{\frac{a}{2}} \int_{\frac{a}{2}}^{a-x} dx dy \Big/ \int_0^a \int_0^y dy dx = \frac{2}{a^2} \int_0^{\frac{a}{2}} x dx = \frac{1}{4}.$$

(iv) Or still again, with the above inequalities, construct a square $OABC$ of side a, OA, OC being the x and y axes. Let P, Q, R, S (Fig. 526) be the mid-points of the sides, T that of the square. The representative point must be in some position on the triangle OBC as $y > x$, and both are positive and neither of them $> a$. The conditions $x < \frac{a}{2}, y > \frac{a}{2}, y - x < \frac{a}{2}$ restrict it further to the triangle TRS , which is obviously $\frac{1}{4}$ of OBC . Hence the chance required is $\frac{1}{4}$.

It will be noted that the integration process is merely the evaluation by that method of the areas of the triangles TRS, OBC .

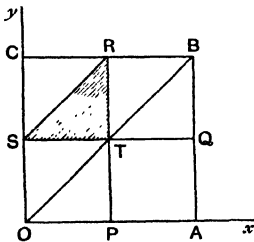

Fig. 526.

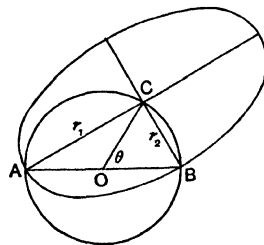

Fig. 527.

4. An ellipse has its centre at a random point C of a semicircle ACB , and two vertices at A, B the extremities of the diameter. $AB=c$. Find (i) the mean area for different positions of C ; (ii) the chance that its area shall be less than that of the circle. (Fig. 527.)

(i) Let O be the centre of the circle; $\widehat{BOC} = \theta, AC=r_1, BC=r_2$.

Then Area of ellipse = $\pi r_1 r_2 = \frac{\pi c^2}{2} \sin \theta$,

and Mean area = $\frac{\pi c^2}{2} \frac{\int_0^\pi \sin \theta d\theta}{\int_0^\pi d\theta} = c^2$.

(ii) When area of ellipse = area of circle, $r_1 r_2 = \frac{1}{2} c^2$, and $\theta = 30^\circ$.

Hence, from $\theta = 30^\circ$ to $\theta = 150^\circ$, we have area of ellipse > area of circle.

Therefore the chance that the area of the ellipse is less than that of the circle = $2 \times \frac{30^\circ}{180^\circ} = \frac{1}{3}$.

5. If a quantity of homogeneous fluid contained in a vessel be thoroughly shaken up and allowed to come to rest again, prove that the chance that no particle of the fluid now occupies its original position is $1/e$.

[WHITWORTH'S PROBLEM.]

Let there be n particles a, β, γ, \dots occupying specific positions :

N the number of ways of arranging them in those positions = $\Pi(n)$,
say, = $n!$,

$N(A)$ the number of ways of arranging them with a in its original place,

$N(a)$ the number of ways of arranging them with a out of its original place,

$N(aB)$ the number of ways of arranging them with β in and a out of their original places, and so on.

Thus $N = \Pi(n)$; $N(A) = \Pi(n-1)$; $N(a) = \Pi(n) - \Pi(n-1)$.

Hence $N(aB) = \Pi(n-1) - \Pi(n-2)$;

$$\therefore N(ab) = N(a) - N(aB) = \Pi(n) - 2\Pi(n-1) + \Pi(n-2)$$

\therefore writing $n-1$ for n , $N(abC) = \Pi(n-1) - 2\Pi(n-2) + \Pi(n-3)$;

\therefore subtracting, $N(abc) = \Pi(n) - 3\Pi(n-1) + 3\Pi(n-2) - \Pi(n-3)$,

and so on.

Thus $N(abc \dots k) = \Pi(n) - n\Pi(n-1) + \frac{n(n-1)}{1 \cdot 2} \Pi(n-2) \dots$ to $n+1$ terms

$$= \Pi(n) \left\{ 1 - 1 + \frac{1}{2!} - \frac{1}{3!} + \dots + (-1)^n \frac{1}{n!} \right\}.$$

Hence the chance that all the particles are misplaced

$$= \lim_{n \rightarrow \infty} \frac{N(a, b, c, \dots)}{n!} = 1 - 1 + \frac{1}{2!} - \frac{1}{3!} + \dots = \frac{1}{e}.$$

[See the Problem of " n letters and n directed envelopes," Smith, *Algebra*, p. 293.]

In this case, although the number of cases is infinite, the problem does not call for the assistance of the Integral Calculus.

6. Find the chance that a random triangle inscribed in a circle is (i) acute angled, (ii) obtuse angled.

(i) Let ABC (Fig. 528) be the triangle; O the centre of the circle. Let the angles AOB, AOC , measured in opposite directions from OA , be called θ and ϕ .

Then $A = (2\pi - \theta - \phi)/2$, $B = \phi/2$, $C = \theta/2$, and if ABC be acute angled, $\theta < \pi$, $\phi < \pi$, $\theta + \phi > \pi$.

The chance for an acute-angled case is therefore

$$\frac{\int_0^\pi \int_{\pi-\theta}^\pi d\theta d\phi}{\int_0^{2\pi} \int_0^{2\pi-\theta} d\theta d\phi} = \frac{\int_0^\pi \theta d\theta}{\int_0^{2\pi} (2\pi - \theta) d\theta} = \frac{1}{4}.$$

(ii) The probability that A is obtuse is

$$\int_0^\pi \int_0^{\pi-\theta} d\theta d\phi / \int_0^{2\pi} \int_0^{2\pi-\theta} d\theta d\phi = \frac{1}{4}.$$

The probability that one of the three A, B or C is obtuse = $\frac{3}{4}$.

The probability that the triangle is right angled is of course infinitesimal.

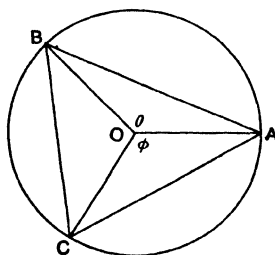

Fig. 528.

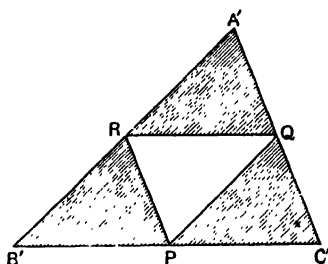

Fig. 529.

(iii) Let us examine this problem in an elementary way. Three points being taken at random on the circumference of a circle, what is the chance that they lie on the same semicircle?

Let the arcs BC, CA, AB be x, y, z ; and take the circumference as unity. Then $x + y + z = 1$. The triangle will be obtuse angled in any of the three cases $y + z < x, z + x < y, x + y < z$.

Interpreting x, y, z as areal coordinates of a point referred to a reference triangle $A'B'C'$, we may proceed as in 3 (i), and if P, Q, R be the mid-points of the sides, the chance required will be the same as the chance that an arbitrary point of the triangle $A'B'C'$ shall fall upon one of the three equal triangles $A'QR, B'RP, C'PQ$ (shaded in Fig. 529), i.e. $\frac{3}{4}$, and the chance the triangle ABC is acute angled is $\frac{1}{4}$.

(iv) A curious fallacy lies in the following argument. One pair of points, say A, B , must lie on a semicircle terminated at A . The chance that C lies on this semicircle is $\frac{1}{2}$; therefore the chance that all three lie on the same semicircle is $\frac{1}{2}$!

This is incorrect: where lies the fallacy? (Rev. T. C. Simmons, *Educ. Times*). Let the student obtain the correct result by this line of argument.

7. Two points P, Q are taken at random within a circle whose centre is C . Prove that the odds are 3 to 1 against the triangle CPQ being acute angled.

[ST. JOHN'S COLL., 1883.]

Let a be the radius; $P, (r, \phi)$, the position of one of the points.

Let a diameter ACB and a chord DPE be drawn perpendicularly to CP . Then (Fig. 530)

(i) The chance that \widehat{PCQ} is obtuse is $\frac{\text{area of a semicircle } AFB}{\text{area of circle}} = \frac{1}{2}$.

(ii) The chance that \widehat{CPQ} is obtuse is the compound chance that P should lie on the particular element $r d\phi dr$, and that if so, Q lies on the smaller segment cut off by the chord, $= \frac{r d\phi dr}{\pi a^2} \times \frac{\text{area of segment}}{\pi a^2}$. There-

fore the whole chance that wherever P lies, \widehat{CPQ} is obtuse is, with the notation indicated in the figure,

$$\int_{\theta=\frac{\pi}{2}}^{\theta=0} \int_{\phi=0}^{\phi=2\pi} r d\phi dr \frac{\frac{1}{2}a^2 2\theta - \frac{1}{2}a^2 \sin 2\theta}{\pi a^2}, \text{ (where } r = a \cos \theta) = \text{etc} = \frac{1}{4}.$$

(iii) Similarly the chance that \widehat{CQP} is obtuse $= \frac{1}{4}$. And these are mutually exclusive events. Therefore the chance that one of the three is obtuse is $\frac{1}{2} + \frac{1}{4} + \frac{1}{4} = \frac{3}{4}$. Therefore the chance that the triangle is acute angled is $\frac{1}{4}$, and the odds against this are 3 to 1.

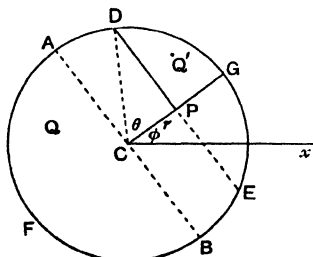

Fig. 530.

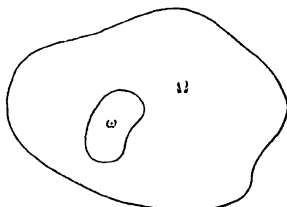

Fig. 531.

1684. We have seen that when a region Ω entirely encloses a second region ω , the chances that a random point taken within Ω should or should not lie within ω are respectively $\frac{\omega}{\Omega}$ and $1 - \frac{\omega}{\Omega}$. If n random points be taken within Ω , the chance that r specified points lie within ω , but the rest do not, is $\left(\frac{\omega}{\Omega}\right)^r \left(1 - \frac{\omega}{\Omega}\right)^{n-r}$; and if the several points be denoted

as A, B, C, \dots , the chance that some unspecified r of them lie within ω , whilst the rest do not, is nC_r times as great, that is ${}^nC_r \left(\frac{\omega}{\Omega}\right)^r \left(1 - \frac{\omega}{\Omega}\right)^{n-r}$. And the chance that *at least* r unspecified points of the whole number lie within ω is

$$\left(\frac{\omega}{\Omega}\right)^n + {}^nC_1 \left(\frac{\omega}{\Omega}\right)^{n-1} \left(1 - \frac{\omega}{\Omega}\right) + \dots + {}^nC_r \left(\frac{\omega}{\Omega}\right)^r \left(1 - \frac{\omega}{\Omega}\right)^{n-r}.$$

Now suppose that the region ω itself is variable with the different trials, and let the regions which it represents in the several trials be denoted by $\omega_1, \omega_2, \omega_3, \dots \omega_m$, and let there be a very large number m of such trials, and that any of these ω 's may be equally likely to be selected for any particular trial of the taking of a random point P within the region Ω . The chance that at any particular trial any specified one value of ω , say ω_p , is selected is $\frac{1}{m}$, and therefore that r specified points of the whole group should fall within ω_p , and the rest not within it, we have the compound chance

$$\frac{1}{m} \left(\frac{\omega_p}{\Omega}\right)^r \left(1 - \frac{\omega_p}{\Omega}\right)^{n-r}.$$

Hence in all the m trials the chance that r specified points lie within the particular ω selected for each trial, and that the rest do not, is

$$\sum_{p=1}^{p=m} \frac{1}{m} \left(\frac{\omega_p}{\Omega}\right)^r \left(1 - \frac{\omega_p}{\Omega}\right)^{n-r} = \text{the mean value of } \left(\frac{\omega_p}{\Omega}\right)^r \left(1 - \frac{\omega_p}{\Omega}\right)^{n-r}.$$

And if the r points be not *specific* points of the group A, B, C, \dots which are to fall within the selected ω 's, the result will be the mean value of ${}^nC_r \left(\frac{\omega_p}{\Omega}\right)^r \left(1 - \frac{\omega_p}{\Omega}\right)^{n-r}$. That is, the two results are

$$M \{ \omega_p^r (\Omega - \omega_p)^{n-r} \} / \Omega^n \quad \text{or} \quad {}^nC_r M \{ \omega_p^r (\Omega - \omega_p)^{n-r} \} / \Omega^n,$$

according as the random points falling within the particular ω 's are to be specified or unspecified members of the group of random points A, B, C, \dots .

It is convenient to picture the two cases as those of n sand grains thrown at random upon the region Ω , the grains being coloured differently in the first case, uncoloured and indistinguishable in the second.

1685. Taking, for instance, the case of a rod AB of length a ; this is the region Ω . Take two points at random upon it. This marks a random region ω , viz. PQ , within Ω . Now take n other random points on AB , say differently coloured sand grains thrown at hazard upon the line. The chance that a specified group of r of these lies between P and Q , and the rest do not, $= M\{PQ^r(a-PQ)^{n-r}\}/a^n$; and if the group be unspecified, the chance will be $= {}^nC_r M\{PQ^r(a-PQ)^{n-r}\}/a^n$.

Let P be the random point which is the nearer to A ; $AP=x$, $AQ=y$.

$$\begin{aligned} \text{Then } M\{PQ^r(a-PQ)^{n-r}\} &= \int_0^a \int_0^y (y-x)^r (a-y+x)^{n-r} dy dx / \int_0^a \int_0^y dy dx \\ &= \frac{2}{a^2} \int_0^1 \int_0^{a(1-z)} a^n z^r (1-z)^{n-r} a dz d\xi \left[\text{putting } y-x=az, x=\xi, \frac{d(y,x)}{d(z,\xi)}=a \right] \\ &= 2a^n \int_0^1 z^r (1-z)^{n-r+1} dz = 2a^n \Gamma(r+1) \Gamma(n-r+2) / \Gamma(n+3) = 2a^n \frac{n-r+1}{(n+2)(n+1)} \cdot \frac{1}{n C_r}. \end{aligned}$$

Therefore the chance required for r specified points, and r only, to lie between P and Q is $\frac{2(n-r+1)}{(n+2)(n+1)} \cdot \frac{1}{n C_r}$, and if the r points be unspecified $= \frac{2(n-r+1)}{(n+2)(n+1)}$.

1686. This result is obtainable directly. For the total number of points to be chosen on AB is $n+2$. The number of permutations of these is $(n+2)!$. Let us fix positions for two of these, X and Y , on the array, say the l^{th} and m^{th} . Then there are $n!$ permutations of the remaining points. Hence the chance that two particular points X and Y shall be the l^{th} and m^{th} of the array $= \frac{2 \cdot n!}{(n+2)!}$, for these two may stand in either order, either as first and $(r+2)^{\text{th}}$, second and $(r+3)^{\text{th}}$, third and $(r+4)^{\text{th}}$, ... $(n-r+1)^{\text{th}}$ and $(n+2)^{\text{th}}$, i.e. in $n-r+1$ ways, events equally likely to occur, and therefore the total chance that these two points shall find r unspecified other points between them is $\frac{2(n-r+1)}{(n+1)(n+2)}$.

1687. For instance, if there be eight indistinguishable points taken at hazard on AB after P, Q have been selected at random, the chance that three unspecified ones should lie between P and Q and five on the rest of the line AB is $\frac{2 \cdot 6}{10 \cdot 9} = \frac{2}{15}$, and the chance for three specified ones to lie between P and Q and the others on the rest of the line is

$$\frac{2}{15} \cdot \frac{1}{{}^3C_3} = \frac{2}{15} \cdot \frac{1}{56} = \frac{1}{420}.$$

1688. Random Points.

It is necessary to examine carefully what is meant when it is stated that points are taken at random within a given region.

(i) When a point P is said to be taken at random upon a line AB of length a , it is understood that AB is divided into an infinite number of equal elements, and that each element has the same chance of finding itself the recipient of the point

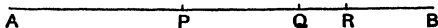

Fig. 532.

P . Thus, measuring a length x along AB from A , the chance of the random point P falling between x and $x+dx$ is dx/a .

If a random selection of several points P, Q, R be made upon the line, the chances they will severally fall between the respective distances x and $x+dx, y$ and $y+dy, z$ and $z+dz$ from A are $dx/a, dy/a$ and dz/a , and the compound chance that all three chances should concur is $\frac{dx}{a} \cdot \frac{dy}{a} \cdot \frac{dz}{a}$, dx, dy, dz denoting increments of equal length.

But if, *after* a choice of P and Q has been made at random, R is then selected at random between P and Q , the respective chances are $dx/a, dy/a, dz/(y-x)$; for now the possible region for the selection of a position for R has been restricted. The compound chance that all three things should happen is $\frac{dx}{a} \cdot \frac{dy}{a} \cdot \frac{dz}{y-x}$.

If a rod be broken simultaneously at two points at random, the chance that one fracture lies at a distance between x and $x+dx$ from A , and that the other lies between the distances y and $y+dy$ from A , is $\frac{dx}{a} \cdot \frac{dy}{a}$. But if the rod be first broken at P and then the portion AP be again broken at Q , the chance that these fractures should respectively lie at distances from A between x and $x+dx$ and between y and $y+dy$ is $\frac{dx}{a} \cdot \frac{dy}{x}$.

(ii) When a point P is said to be taken at random on a given area A or within a volume V , then, if R be the whole region in question, and if R be divided up into an infinite number of equal infinitesimally small regions $\delta R, \delta R', \delta R'', \dots$, it is understood that each element has the same chance of finding itself the recipient of the point P , and the chance

that specified points P, P', P'', \dots should occupy the respective elements $\delta R, \delta R', \delta R'', \dots$ is $\frac{\delta R}{R} \cdot \frac{\delta R'}{R} \cdot \frac{\delta R''}{R} \dots$

1689. To return to the case of a distribution of possible positions on a line $AB (=a)$. If, *after* a random selection of one point P on AB , a selection of Q be made at hazard upon

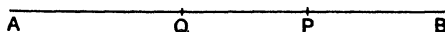

Fig. 533.

AP , it is evident that, since the number of possible positions for Q on AP is smaller than the number of possible positions for P in the whole line AB , the chance of any one element of AP distant between y and $y+dy$ from A being the recipient of Q is greater than that of the element between x and $x+dx$ being the recipient of P . The circumstance of the random choice of Q being made subsequently to the random choice of P , upon a limited range, has increased the chance of the dy element, but all equal elements between A and P have the same chance, the compound chance being, as before stated, $\frac{dx}{a} \cdot \frac{dy}{x}$.

1690. We have, then, for the total chance that AQ shall not be less than a certain length $c (<a)$,

$$\frac{\int_c^a \int_0^x \frac{dx}{a} \frac{dy}{x}}{\int_0^a \int_0^x \frac{dx}{a} \frac{dy}{x}} = \frac{\int_c^a \frac{dx}{ax} \cdot (x-c)}{\int_0^a \frac{dx}{ax} \cdot x} = \frac{a-c-c \log_e \frac{a}{c}}{a}$$

1691. Thus for a rod four feet long and AQ to exceed one foot, the chance $= (3 - \log 4)/4 = 4034\dots$

1692. It will be observed from Art. 1690 that for the compound event the chance of the element between x and $x+dx$ being the recipient of the random point P , and also being such that the subsequent random choice of Q will give a result for which $AQ < c$, is no longer $\frac{dx}{a}$ but $\frac{x-c}{x} \frac{dx}{a}$, and therefore the density of the possible positions of P on the line is not the same at various positions, but varies as $1 - \frac{c}{x}$, i.e. in a hyper-

bolic manner. This "density" of distribution may be represented graphically as in Fig. 534, and shows that the condensation of points P in an element dx , which can bring about a value AQ greater than c , increases from zero at $x=c$, and continues its increase as P approaches B , tending in a hyperbolic manner to an asymptote parallel to the x -axis.

Taking $\eta = k \frac{x-c}{x}$ as the equation of this graph, ηdx is a measure of the number of cases in which P lies in the element dx . That is, this number is proportional to the ordinate of the graph. And the total number of cases is measured on the same scale by the area between the x -axis, the curve and the ordinate at $x=a$. This area up to any definite ordinate is

$$\int_c^x k \frac{x-c}{x} dx = k \left\{ x - c - c \log \frac{x}{c} \right\}.$$

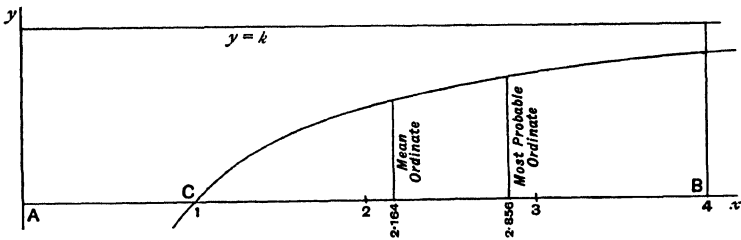

Fig. 534.

If we take an ordinate which bisects the whole area, viz. $x = x_0$, we have $k \left(x_0 - c - c \log \frac{x_0}{c} \right) = \frac{1}{2} k \left(a - c - c \log \frac{a}{c} \right)$; and this ordinate divides the whole line AB into two portions such that there are as many favourable cases for the event desired in defect of $AP (=x_0)$ as there are in excess. On these grounds the value $x = x_0$ is said to give the most probable case to secure the event.

In the case $a = 4$ feet, $c = 1$ foot, $x_0 - 1 - \log x_0 = \frac{1}{2} (3 - \log 4) = 0.8068$.

$\therefore x_0 - \log x_0 = 1.8068$, and by trial, or graphically, $x_0 = 2.8563$ nearly.

That is, in order that the portion AQ should exceed one-fourth of the rod, the most likely position for the first fracture to have been made is a little less than three-fourths of the length of the rod from A .

We shall call such a graph, indicating the density or condensation of points P in an element which are such that the

event may be brought to pass, the "Condensation" or "Density" graph. We shall return to it later. It is also sometimes called the "Curve of Frequency." (See Williamson, *Int. Calc.*, p. 369, ed. 8.)

In all previous cases the density or condensation has been uniform. It will now appear that many cases will arise when this is not so.

The mean value of the ordinates of the graph from $x=c$ to $x=a$ is given by

$$\int_c^a k \frac{x-c}{x} dx / \int_c^a dx = k \left(a-c - c \log \frac{a}{c} \right) / (a-c) = k - \frac{kc}{a-c} \log \frac{a}{c},$$

for which the abscissa is $\frac{a-c}{\log a - \log c}$.

In the numerical case cited, viz. $a=4$, $c=1$, $x=3/\log_e 4 = 2.164\dots$

1693. Illustrative Examples.

1. From a rod of given length a piece is cut off. From the remainder another piece is cut off. Show that the chance that the second piece is less than the first is $\log_e 2$.

Let $OA (=a)$ be the rod; P and Q the fractures; $OP=x$, $OQ=y$. Then $y > x$, $y-x < x$, $y < a$.

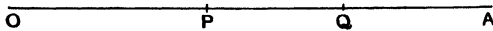

Fig. 535.

So that if $x < a/2$, $y < 2x$; but if $x > a/2$, y cannot range as far as $2x$, and the inequality $y < 2x$ is necessarily satisfied and replaced by $y < a$, i.e.

when x ranges from 0 to $\frac{1}{2}a$, y ranges from x to $2x$;

when x ranges from $\frac{1}{2}a$ to a , y ranges from x to a .

The chance of R lying between x and $x+dx$ is dx/a , and the chance of Q lying between y and $y+dy$ is $dy/(a-x)$.

Thus the chance required = $\int_0^{\frac{1}{2}a} \int_x^{2x} \frac{dx}{a} \frac{dy}{a-x} + \int_{\frac{1}{2}a}^a \int_x^a \frac{dx}{a} \frac{dy}{a-x} = \text{etc.} = \log_e 2$.

2. (i) Find the average distance between two points P and Q , where P is taken at random on a line AB of length a and Q is taken at random on AP .

[MATH. TRIP., 1883.]

Let $AP=x$, $AQ=y$, $x \leq y$.

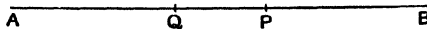

Fig. 536.

Then

$$M(QP) = \frac{\int_0^a \int_0^x (x-y) \frac{dx}{a} \frac{dy}{x}}{\int_0^a \int_0^x \frac{dx}{a} \frac{dy}{x}} = \text{etc.} = \frac{a}{4}.$$

(ii) Find the average distance between the two points P and Q when P and Q are taken at random on AB . [MATH. TRIP., 1883.]

Here Q may be on either side of P , and $x - y$ changes sign as Q passes P

$$M(\text{positive value of } QP) = \frac{\int_0^a \int_0^x (x-y) \frac{dx}{a} \frac{dy}{a} + \int_0^a \int_x^a (y-x) \frac{dx}{a} \frac{dy}{a}}{\int_0^a \int_0^a \frac{dx}{a} \frac{dy}{a}} = \text{etc.} = \frac{a}{3}.$$

3. Two lines are taken at random, each of length $< a$. Prove that the chance that, together with a line of length $\frac{1}{2}a$, they can form the three sides of a triangle is $\frac{5}{8}$. [ST. JOHN'S, 1883]

(i) If $x, y, \frac{1}{2}a$ be the sides, we have

$$x < a, \quad y < a, \quad x + y > \frac{1}{2}a, \quad y + \frac{1}{2}a > x, \quad x + \frac{1}{2}a > y.$$

Take x, y as Cartesian coordinates of a point. Construct a square $OABC$ of side a , with OA, OC as coordinate axes. Let P, Q, R, S be the mid-points of the sides (Fig. 537). Then, of all points within the square, any point within the shaded area $PSBRQ$ will satisfy the conditions of the problem. Hence the chance required is $\frac{5}{8}$.

(ii) Or we may proceed directly thus: The chance that x lies between x and $x + dx$, and that y lies between y and $y + dy$, is $dx dy/a^2$.

If $x < \frac{a}{2}$, y ranges from $\frac{a}{2} - x$ to $\frac{a}{2} + x$; if $x > \frac{a}{2}$, y ranges from $x - \frac{a}{2}$ to a .

$$\text{Therefore the chance required} = \int_0^{\frac{a}{2}} \int_{\frac{a}{2}-x}^{\frac{a}{2}+x} \frac{dx dy}{a^2} + \int_{\frac{a}{2}}^a \int_{x-\frac{a}{2}}^a \frac{dx dy}{a^2} = \text{etc.} = \frac{5}{8}.$$

It will be noted that this is the exact process of integrating $dx dy/a^2$ over the shaded area.

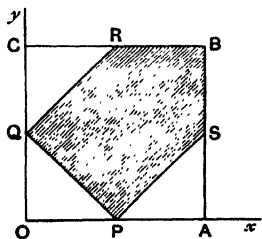

Fig. 537.

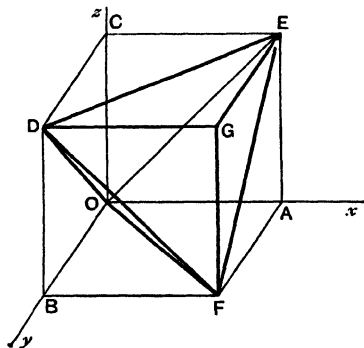

Fig. 538.

4. Three lines are chosen at random, each of length $< a$. Prove that the chance that they can form a triangle is $\frac{1}{2}$.

If x, y, z be the lengths, we must have $x < a$, etc.; $y + z > x$, etc.

Consider x, y, z the rectangular coordinates of a point. Of all points within a cube of edge a , three of whose edges coincide with the axes of

coordinates, those which give the result sought must be included between the three planes $y+z=x$, $z+x=y$, $x+y=z$, i.e. half the whole cube. Hence the chance is $\frac{1}{2}$.

5. A rod of length a is broken at random into two parts, and one of the two parts is taken at random and again broken at random. Show that for the two parts thus obtained the chance that neither is less than $\frac{1}{3}a$ is $\frac{1}{3}$.

[Ox. II. P., 1886.]

Let OQ be the part first broken off (Fig. 539), P the second fracture; $OP=x$, $PQ=y$, $QA=z$, $x+y+z=a$. Unless $x+y > 2a/3$ there is no chance that x and y shall be each $> a/3$. Therefore the larger portion must be

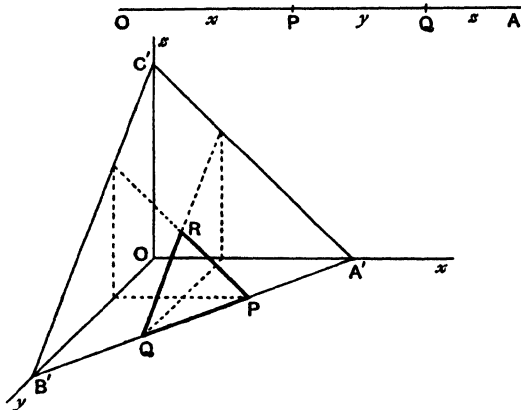

Fig. 539.

selected. Regard x, y, z as the rectangular coordinates of a point. This must lie on a plane $A'B'C'$ making equal intercepts a on the coordinate axes. The planes $x=a/3$, $y=a/3$, $z=0$ isolate on the triangle $A'B'C'$, a triangle PQR whose area is $\frac{1}{3}$ that of the triangle $A'B'C'$. In order that the specified condition must be satisfied, the representative point x, y, z must lie within the triangle PQR . The chance is therefore $\frac{1}{3}$.

6. If three points P, Q, R be taken at random on a straight line $OA (=a)$, what is the chance that, if $n > 3$, $OP^2 + PQ^2 + QR^2 + RA^2$ shall be $> \frac{n+1}{4n} a^2$?

Let $OP=x$, $PQ=y$, $QR=z$. Then $RA=a-x-y-z$, and we are to have $x^2 + y^2 + z^2 + (a-x-y-z)^2 > \frac{n+1}{4n} a^2$, whilst x, y, z are positive and their sum $< a$.

Take an orthogonal transformation in which

$$x+y+z=Z\sqrt{3} \quad \text{and} \quad x^2+y^2+z^2=X^2+Y^2+Z^2,$$

where X, Y, Z are new variables. Then

$$X^2+Y^2+Z^2+(a-Z\sqrt{3})^2 > \frac{n+1}{4n} a^2, \quad \text{i.e.} \quad X^2+Y^2+4\left(Z-\frac{a\sqrt{3}}{4}\right)^2 > \frac{a^2}{4n}.$$

The whole range of the values of X, Y, Z is comprised within a spheroid of semi-axes $a/2\sqrt{n}, a/2\sqrt{n}, a/4\sqrt{n}$, which lies entirely within the tetrahedron $x=0, y=0, z=0, x+y+z=a$, provided n be large enough. The centre of the spheroid is at the point given by $x=y=z=a-x-y-z$, i.e. $(a/4, a/4, a/4)$. The minor axis lies along $x=y=z$. The perpendicular from the centre on the plane $x+y+z=a$ is $a/4\sqrt{3}$, and the minor semi-axis being $a/4\sqrt{n}$, we must have $n > 3$ in order that the spheroid shall not cut the face $x+y+z=a$. The same limitation will secure that the spheroid shall not cut any of the other faces of the tetrahedron, and must therefore be completely contained by the tetrahedron. With this limitation we therefore have

$$\text{Chance required} = \frac{\text{Vol. Spheroid}}{\text{Vol. Tetrahedron}} = \frac{\pi}{2n\sqrt{n}}$$

7. If n random points P, Q, R be taken upon a line OA , what is the chance that the sum of the squares of the $(n+1)$ parts shall not exceed $\frac{1}{n}$ the square of the whole line?

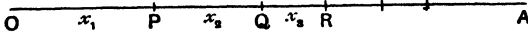

Fig. 540.

Let $x_1, x_2, x_3, \dots, x_n, a-x_1-x_2-\dots-x_n$, be the lengths of the successive parts. We are to have $x_1^2+x_2^2+\dots+(a-x_1-\dots-x_n)^2 \geq a^2/n$.

Take an orthogonal transformation in which $x_1+x_2+\dots+x_n = \sqrt{n}X_n$, and let X_1, X_2, \dots, X_n be the new variables. Then $\sum_1^n x_r^2 = \sum_1^n X_r^2$, and the condition becomes

$$X_1^2 + X_2^2 + \dots + X_n^2 + (a - \sqrt{n}X_n)^2 \geq a^2/n.$$

i.e. $X_1^2 + X_2^2 + \dots + (n+1)\{X_n - a\sqrt{n}/(n+1)\}^2 \geq a^2/n(n+1)$

or $X_1^2 + X_2^2 + \dots + X_{n-1}^2 + X_n^2 \geq a^2/n(n+1)$,

where $X_n - a\sqrt{n}/(n+1) = X_n'/\sqrt{n+1}$.

With the new variables the signs of X_1, X_2, \dots may be either positive or negative.

The chance required is N/D , where $N = \int \int \dots \int dX_1 dX_2 \dots dX_{n-1} \frac{dX_n'}{\sqrt{n+1}}$,

for all values of $X_1, X_2, \dots, X_{n-1}, X_n'$, for which

$$X_1^2 + X_2^2 + \dots + X_{n-1}^2 + X_n'^2 \geq a^2/n(n+1) \quad (\text{see note in the next article});$$

and $D = \int \int \dots \int dx_1 dx_2 \dots dx_n$ for positive values of x_1, x_2, \dots, x_n , for which $x_1+x_2+\dots+x_n \geq a$.

By Dirichlet's theorem $N = \frac{\left\{ \frac{a^2}{n(n+1)} \right\}^{\frac{n}{2}} \left\{ \Gamma\left(\frac{1}{2}\right) \right\}^n}{\Gamma\left(\frac{n}{2}+1\right)} \frac{1}{\sqrt{n+1}} 2^n$, the last

factor 2^n occurring because at each integration the result is to be doubled to take into account the negative signs of the respective variables;

$$\therefore N = \left\{ \frac{\pi a^2}{n(n+1)} \right\}^{\frac{n}{2}} \frac{1}{\sqrt{n+1} \Gamma\left(\frac{n}{2}+1\right)}, \text{ and } D = \frac{a^n \{\Gamma(1)\}^n}{1^n \Gamma(n+1)};$$

$$\therefore \text{the chance required} = \frac{1}{\sqrt{n+1}} \left\{ \frac{\pi}{n(n+1)} \right\}^{\frac{n}{2}} \frac{\Gamma(n+1)}{\Gamma\left(\frac{n+2}{2}\right)}.$$

1694. NOTE.

Consider the equations

$$x_1^2 + x_2^2 + \dots + x_{n+1}^2 = a^2/p, \quad x_1 + x_2 + \dots + x_{n+1} = a (+ \text{ve}).$$

Multiplying the second by $2a/n$ and subtracting,

$$\left(x_1 - \frac{a}{n}\right)^2 + \left(x_2 - \frac{a}{n}\right)^2 + \dots + \left(x_{n+1} - \frac{a}{n}\right)^2 = a^2 \left(\frac{1}{p} - \frac{1}{n} + \frac{1}{n^2}\right);$$

and therefore when one of the x 's is zero, say x_{n+1} ,

$$\sum_1^n \left(x_r - \frac{a}{n}\right)^2 = a^2 \left(\frac{1}{p} - \frac{1}{n}\right);$$

and if $p > n$, this would be negative, and therefore impossible to be satisfied by any real values of x_1, x_2, \dots, x_n . If $p = n$, the unique real solution would be $x_1 = x_2 = \dots = x_n = a/n$, where $x_{n+1} = 0$; and similarly if any of the other x 's were zero. We may suppose x_{n+1} as an abbreviation for $a - x_1 - x_2 - \dots - x_n$, and x_1, x_2, \dots, x_n as generalised coordinates.

(i) If $n = 2$, $x_1^2 + x_2^2 + x_3^2 = a^2/2$, where $x_3 = a - x_1 - x_2$, is a conic, and can only meet the lines $x_1 = 0, x_2 = 0, x_3 = 0$ at

$$x_1 = 0, x_2 = a/2, x_3 = a/2; \quad x_1 = a/2, x_2 = 0, x_3 = a/2; \quad x_1 = a/2, x_2 = a/2, x_3 = 0;$$

i.e. it is the ellipse which touches the lines $x_1 = 0, x_2 = 0, x_3 = 0$, at the mid-points of the sides of the triangle formed. The centre is at

$$x_1 = x_2 = x_3 = a/3,$$

and the ellipse is the maximum ellipse inscribable in the triangle. In homogeneous coordinates x_1, x_2, x_3 we may write it as

$$2(x_1^2 + \dots) = (x_1 + x_2 + x_3)^2 \quad \text{or} \quad \sqrt{x_1} + \sqrt{x_2} + \sqrt{x_3} = 0.$$

(ii) If $n = 3$, $x_1^2 + x_2^2 + x_3^2 + x_4^2 = a^2/3$, where $x_4 \equiv a - x_1 - x_2 - x_3$, is a spheroid inscribed in the tetrahedron $x_1 = 0, x_2 = 0, x_3 = 0, x_4 = 0$, touching the faces at their several centroids.

In homogeneous coordinates x_1, x_2, x_3, x_4 ,

$$3(x_1^2 + x_2^2 + x_3^2 + x_4^2) = (x_1 + x_2 + x_3 + x_4)^2.$$

The centre is at $x_1 = x_2 = x_3 = x_4 = a/4$, and the spheroid lies entirely within the tetrahedron.

(iii) In the general case,

$$n(x_1^2 + x_2^2 + \dots + x_{n+1}^2) - (x_1 + x_2 + \dots + x_{n+1})^2 = 0$$

may be arranged as

$$(n-1)x_1^2 - 2x_1(x_2 + x_3 + \dots + x_{n+1}) + \sum_{r=2}^{n+1} (x_2 - x_r)^2 + \sum_4^{n+1} (x_3 - x_r)^2 + \dots + (x_n - x_{n+1})^2 = 0.$$

Hence if $n > 1$, x_1 cannot be negative unless $x_2 + x_3 + \dots + x_{n+1}$ be negative, which is impossible, since $x_1 + (x_2 + \dots + x_{n+1}) = a$, which is positive. And the same follows for each of the variables. That is, using language in analogy with the geometrical interpretations of (i) and (ii), the n -dimensional "spheroid" $x_1^2 + x_2^2 + \dots + x_{n+1}^2 = a^2/n$, in which $x_{n+1} \equiv a - x_1 - \dots - x_n$, lies entirely within the n -dimensional "region" defined by $x_1 = 0, x_2 = 0, \dots, x_{n+1} = 0$, and touches each of the "faces," viz., say, $x_1 = 0$ at $(0, \frac{a}{n}, \frac{a}{n}, \dots, \frac{a}{n})$, i.e. at its "centroid," and has its "centre" at $a/(n+1), \dots, a/(n+1)$, i.e. the "centroid" of the region, and may be written

$$\left(x_1 - \frac{a}{n+1}\right)^2 + \left(x_2 - \frac{a}{n+1}\right)^2 + \dots + \left(x_{n+1} - \frac{a}{n+1}\right)^2 = \frac{a^2}{n(n+1)}.$$

It will be seen, therefore, that in the integration of the preceding article it is proper to take the limits for X_1, X_2, \dots for all values of the variables for which $X_1^2 + \dots + X_n^2 \not> a^2/n(n+1)$; for negative values of these variables cannot imply any but positive values of the original variables x_1, x_2, \dots, x_{n+1} .

1695. GENERAL ILLUSTRATIONS.

1. If a rod be divided into p pieces at random, prove that the chance that none of the pieces shall be less than $1/m^{\text{th}}$ of the whole, where $m > p$, is $(1 - p/m)^{p-1}$. [MATH. TRIP., 1875.]

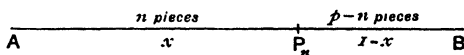

Fig. 541.

Let x be the distance of the n^{th} point of division from one end, and let the length of the rod be taken as unity. Then, as each piece is to be $> 1/m$, we must have

$$x > n/m \text{ and } 1 - x > (p - n)/m, \text{ i.e. } 1 - (p - n)/m > x > n/m.$$

Hence each point of division, P_n , has a favourable range from $x = n/m$ to $x = 1 - p/m + n/m$, and the length of this range is $(1 - p/m)$ of the whole.

And since there are $p - 1$ points of division, the required chance is $(1 - p/m)^{p-1}$.

2. To examine the same problem by means of the Integral Calculus.

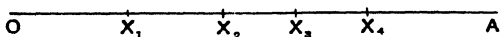

Fig. 542.

If X_1, X_2, \dots be the several points of division of the rod $OA (= a)$ at respective distances x_1, x_2, \dots , from O , we have $x_r > ra/m$ and $< x_{r+1} - a/m$ from $r = 1$ to $r = p - 1$, and $x_p = a = 1$. And the required chance is N/D , where

$$N = \int_{\frac{a}{m}}^{\frac{a-1}{m}} \dots \int_{\frac{2a}{m}}^{\frac{a-1}{m}} \int_{\frac{a}{m}}^{\frac{a-1}{m}} dx_{p-1} dx_{p-2} \dots dx_1;$$

and D is the same when $m = \infty$.

Hence performing the integrations, $N/D = (1 - p/m)^{p-1}$, as before.

3. A rod $XY (=a)$ is broken at hazard into three portions. If these three parts can form the sides of a triangle, what is the chance it is acute angled?

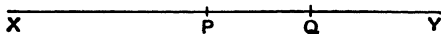

Fig. 543.

In Art. 1683, Ex. 3 (iv), it has been seen that the chance the parts form a triangle is $\frac{1}{4}$.

Let P, Q be the fractures, $XP=x, XQ=y, y > x$. As in the article cited, we must have

$$x < a/2. \quad y < x + a/2, \quad y > a/2.$$

To be acute angled, we must also have

$$(y-x)^2 + (a-y)^2 > x^2, \quad (a-y)^2 + x^2 > (y-x)^2, \quad x^2 + (y-x)^2 > (a-y)^2,$$

i.e. $y(y-x-a) + a^2/2 > 0, \quad y(x-a) + a^2/2 > 0, \quad (x-a)(x-y+a) + a^2/2 > 0.$

All values of x and y from $x=0$ to $x=y$, and $y=0$ to $y=a$, are equally likely. Refer to rectangular axes Ox, Oy , as before, with the same description of figure.

The region bounded by the hyperbolae $y(y-x-a) + a^2/2 = 0$, etc., includes the only positions in which the representative point (x, y) can lie to ensure that the triangle formed by the portions of the rod shall be acute

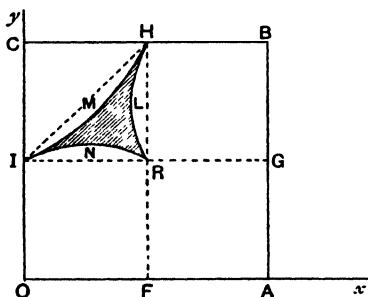

Fig. 544.

angled. These hyperbolae, which we designate as L, M, N respectively, pass through R and H, H and I, I and R , and touch each other at these points. The three segments bounded by L, M, N and their respective chords are

$$\text{for } L, \int_{\frac{a}{2}}^a \left(\frac{a}{2} - x\right) dy = \int_{\frac{a}{2}}^a \left(\frac{3a}{2} - y - \frac{a^2}{2y}\right) dy = \frac{3}{8}a^2 - \frac{a^2}{2} \log 2;$$

$$\text{for } M, \int_{\frac{a}{2}}^a \left\{ \left(a - \frac{a^2}{2y}\right) - \left(y - \frac{a}{2}\right) \right\} dy = \frac{3}{8}a^2 - \frac{a^2}{2} \log 2;$$

$$\text{for } N, \int_0^{\frac{a}{2}} \left(y - \frac{a}{2}\right) dx = \int_0^{\frac{a}{2}} \left(x + \frac{a}{2} - \frac{a^2}{2(a-x)}\right) dx = \frac{3}{8}a^2 - \frac{a^2}{2} \log 2.$$

Therefore the area of the curvilinear triangle *RHI*

$$= \frac{a^2}{8} - 3\left(\frac{3}{8}a^2 - \frac{1}{2}a^2 \log 2\right) = \left(\frac{3}{8} \log 2 - 1\right) a^2.$$

Therefore the chance that the three segments of the rod form an acute-angled triangle $= \left(\frac{3}{8} \log 2 - 1\right) a^2 / \frac{1}{8} a^2 = 3 \log 2 - 2.$

The chance that any specific angle is obtuse

$$= \left(\frac{3}{8} a^2 - \frac{a^2}{2} \log 2\right) / \frac{a^2}{2} = (3 - 4 \log 2) / 4.$$

The chance that the triangle is obtuse angled $= \frac{3}{4}(3 - 4 \log 2).$

The chance that the triangle is right angled is of course infinitesimally small.

4. *P, Q, R are random points, one on each of three equal lines $X_1Y_1, X_2Y_2, X_3Y_3 (= a)$. What is the chance that the portions X_1P, X_2Q, X_3R may form an acute-angled triangle?*

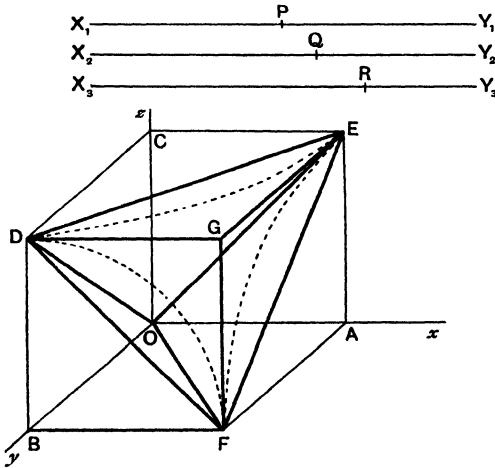

Fig. 545.

In Art. 1693, 4, the chance the parts form a triangle has been seen to be $\frac{1}{2}$. If x, y, z be respectively X_1P, X_2Q and X_3R , we have the additional conditions $y^2 + z^2 > x^2, z^2 + x^2 > y^2, x^2 + y^2 > z^2$. Referring to rectangular axes, as before, the surfaces of the right cones $y^2 + z^2 = x^2$, etc., separate the favourable positions of the representative point from the unfavourable ones. These cones touch in pairs along their common generators, which lie in the coordinate planes. The volume of the part of the cube included between them

$$= a^3 - 3 \cdot \frac{1}{3} \cdot \frac{\pi a^2}{4} \cdot a = \left(1 - \frac{\pi}{4}\right) a^3.$$

Hence the chance required $= \left(1 - \frac{\pi}{4}\right) a^3 / a^3 = 1 - \frac{\pi}{4} = \cdot 2146\dots$

5. Two points P and Q are taken at hazard upon a line $AB (= a)$, P being the nearer to A . What is the chance that the sum of the products of the segments two and two together exceeds one-fourth of the square of the line?

Let $AP = x$, $AQ = y$, $y > x$. Then x ranges from 0 to y and y from 0 to a .

The limiting case is $x(y-x) + (y-x)(a-y) + (a-y)x = \frac{a^2}{4}$.

Referring to rectangular coordinates Ox , Oy , the representative point x, y may lie anywhere within the half OBC of a square $OABC$ of side a , whose sides OA , OB are along the axes Ox , Oy ; and the favourable cases are indicated by points lying within the ellipse $x^2 - xy + y^2 - ay + \frac{a^2}{4} = 0$,

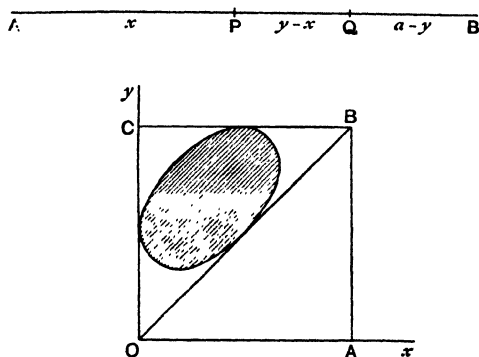

Fig. 546.

which touches the sides of the triangle OBC at their mid-points, and is the maximum inscribed ellipse.

By projection its area is to that of the triangle OBC in the ratio of that of a circle inscribed in an equilateral triangle to that of the equilateral, i.e. $\pi/3\sqrt{3}$. The chance required is therefore $\pi/3\sqrt{3}$.

6. A rod of length a is broken at random into three parts. What is the chance that the square on the mean segment shall be less than the rectangle contained by the other two?

Let x, y, z be the lengths of the segments. Suppose y the mean segment. Then

$$x > y > z \text{ or } x < y < z; \quad x + y + z = a; \quad y^2 < zx.$$

Refer to rectangular axes Ox, Oy, Oz . Let $OA = OB = OC = a$ (Fig. 547). Then $x + y + z = a$ is the plane ABC . Let D, E, F , be the mid-points of the sides, G the point $(a/3, a/3, a/3)$. The equations of the planes COF and AOD are respectively $y = x$ and $y = z$.

The inequalities $y < x$ and $y < z$ for points on the plane ABC limit the region to the triangle AGF .

The cone $y^2 = zx$ has OA and OC for generators, the coordinate planes $x=0$ and $z=0$ being tangential, and it passes through G , cutting the plane ABC in an arc $APGQC$. For points of the triangle AGB on the concave side of the arc we have $y^2 < zx$. This further limits the range

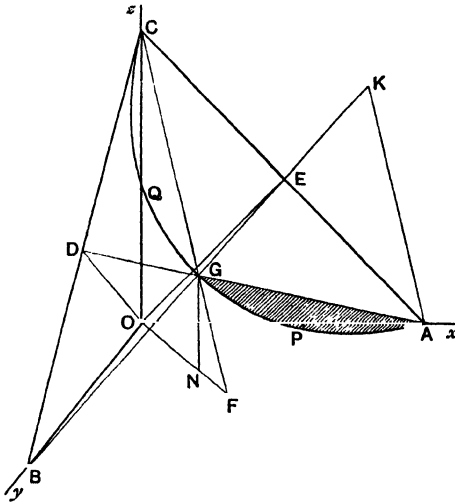

Fig. 547.

of the representative point x, y, z to the segment $APGA$. Therefore, for the case $x > y > z, y^2 < zx$, the chance required = Area $APGA$ /Area ABC .

Now, since $2xz = (a - y)^2 - x^2 - z^2$, we have along the intersection of the cone and the plane $ABC, x^2 + y^2 + z^2 + 2ay = a^2$; so that it is possible to pass a sphere through the arc $APQC$, which is therefore circular, as may be seen geometrically, the centre being at the point K where AK drawn parallel to FG meets BE produced. The radius of this circle = $a\sqrt{2/3}$; and Area $APGA = \frac{1}{2} \cdot \frac{2a^2}{3} \cdot \frac{\pi}{3} - \frac{1}{2} \cdot \frac{2a^2}{3} \cdot \frac{\sqrt{3}}{2} = \frac{a^2}{18} (2\pi - 3\sqrt{3})$.

Hence for this case the chance is $\frac{a^2}{18} (2\pi - 3\sqrt{3}) / \frac{a^2}{2} \sqrt{3} = \frac{2\pi\sqrt{3} - 9}{27}$.

There are six such cases, viz.

$$\left. \begin{matrix} x > y > z \\ x < y < z \end{matrix} \right\} \text{ with } y^2 < zx; \quad \left. \begin{matrix} y > z > x \\ y < z < x \end{matrix} \right\} \text{ with } z^2 < xy; \quad \left. \begin{matrix} z > x > y \\ z < x < y \end{matrix} \right\} \text{ with } x^2 < yz.$$

Therefore the total chance = $\frac{a^2}{27} (2\pi\sqrt{3} - 9) = \frac{2}{3} (2\pi\sqrt{3} - 9) = .418399\dots$

If a specific segment of the line, say the middle one, is to satisfy the same conditions, we then have the two cases $x > y > z, x < y < z$, with $y^2 < zx$, and the chance is $\frac{2}{27} (2\pi\sqrt{3} - 9)$, i.e. one-third of the total chance considered above.

7. A rectangular parallelepiped is constructed with a given diagonal, and edges of any possible lengths are equally likely. What is the chance that a triangle could be constructed with its sides equal to those edges of the parallelepiped which meet in a point?

Let x, y, z be the edges, a the diagonal. Then $x^2 + y^2 + z^2 = a^2$; $y + z > x$, $z + x > y$, $x + y > z$. Referring the problem to a set of rectangular axes, the planes $y + z = x$, etc., form a spherical triangle PQR on a sphere of radius a . The points P, Q, R are the mid-points of the sides of the quadrantal triangle ABC formed on the sphere $x^2 + y^2 + z^2 = a^2$ by the coordinate planes. The sides of the triangle PQR are each $\pi/3$, and

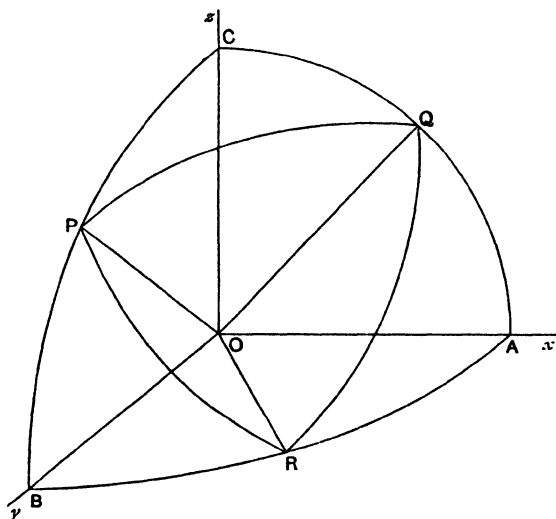

Fig. 548.

$\cos P = \cos Q = \cos R = \frac{1}{3}$. The spherical excess $= 3 \cos^{-1} \frac{1}{3} - \pi$. The area of the triangle $PQR = a^2 (3 \cos^{-1} \frac{1}{3} - \pi)$. The area of the triangle $ABC = \frac{1}{2} \pi a^2$. The "favourable" region for x, y, z consists of the three spherical triangles, AQR, BRP, CPQ , the sum of whose areas

$$= \frac{\pi a^2}{2} - a^2 \left(3 \cos^{-1} \frac{1}{3} - \pi \right) = 3a^2 \left(\frac{\pi}{2} - \cos^{-1} \frac{1}{3} \right) = 3a^2 \sin^{-1} \frac{1}{3}.$$

Hence the required chance $= \frac{6}{\pi} \sin^{-1} \frac{1}{3}$.

8. A rod AB ($= a$) is broken at hazard at two points P, Q . What is the chance that PQ shall be such that $PQ^2 < \frac{1}{n} (AP^2 + QB^2)$?

Let $AP = x, PQ = z, QB = y, x + y + z = a$, and we are to have $nz^2 < x^2 + y^2$. Refer, as before, to rectangular axes Ox, Oy, Oz . Then, of all points in

the plane $x+y+z=a$ (Fig. 549), those which lie within the right circular cone $x^2+y^2=nz^2$ are "favourable." The projection $A''B''$ of the line of intersection $A'B'$ upon the z -plane is $x^2+y^2=n(a-x-y)^2$, i.e.

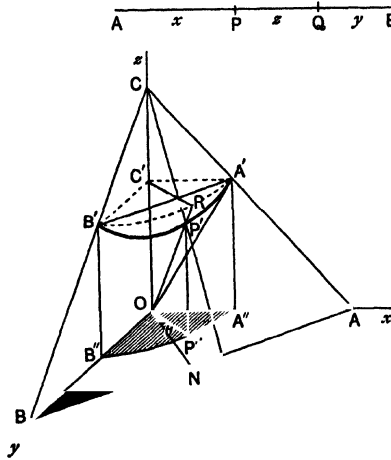

Fig. 549.

a conic with focus at O , directrix $x+y=a$, eccentricity $\sqrt{2n}$. Turning the axes round so that ON , the perpendicular upon $x+y=a$, is the new x -axis, the conic becomes $X^2+Y^2=n(a-X\sqrt{2})^2$, i.e. in polars

$$a\sqrt{n}/r = 1 + \sqrt{2n} \cos \theta.$$

The area of the portion of this conic between the radii OA'' , OB'' (Fig. 549), in the case when $n < \frac{1}{2}$, is

$$\frac{1}{2} \int_{-\frac{\pi}{4}}^{\frac{\pi}{4}} r^2 d\theta = \frac{a^2 n}{2} \int_{-\frac{\pi}{4}}^{\frac{\pi}{4}} \frac{d\theta}{(1 + \sqrt{2n} \cos \theta)^2} = \text{etc.} = \frac{a^2 n}{(1 - 2n)^{\frac{3}{2}}} \left[\cos^{-1} \frac{1 + 2\sqrt{n}}{\sqrt{2}(1 + \sqrt{n})} - \sqrt{n} \frac{\sqrt{1 - 2n}}{1 + \sqrt{n}} \right].$$

And the chance required

$$= \text{Area } OA''B'' / \text{Area } OAB = \frac{2n}{(1 - 2n)^{\frac{3}{2}}} \left[\cos^{-1} \left(\frac{1 + 2\sqrt{n}}{1 + \sqrt{n}} \cdot \frac{1}{\sqrt{2}} \right) - \sqrt{n} \frac{\sqrt{1 - 2n}}{1 + \sqrt{n}} \right].$$

If $n = \frac{1}{2}$, the conic $A''B''$ is a parabola, viz. $a/r\sqrt{2} = 2 \cos^2 \frac{\theta}{2}$.

In this case, $\text{Area } OA''B'' = \frac{a^2}{8} \int_0^{\frac{\pi}{4}} \sec^4 \frac{\theta}{2} d\theta = \text{etc.} = \frac{a^2}{6} (4\sqrt{2} - 5)$,

and the chance required $= (4\sqrt{2} - 5)/3 = .21895 q \cdot p$.

If $n > \frac{1}{2}$, the conic $A''B''$ is hyperbolic, and the chance required is

$$= \frac{2n}{(2n - 1)^{\frac{3}{2}}} \left\{ \sqrt{n} \frac{\sqrt{2n - 1}}{\sqrt{n + 1}} - \cosh^{-1} \frac{2\sqrt{n + 1}}{\sqrt{2}(\sqrt{n + 1})} \right\},$$

9. The equation $ax^2 + 2hxy + by^2 = 1$ is written down at random with real coefficients. Find the chance that it represents a hyperbola.

[Ox. II. P., 1887.]

The condition is $h^2 > ab$. Consider the portion of the volume of the cone $z^2 = xy$ enclosed by the planes $x = \pm c$, $y = \pm c$, $z = \pm c$. Let PMN

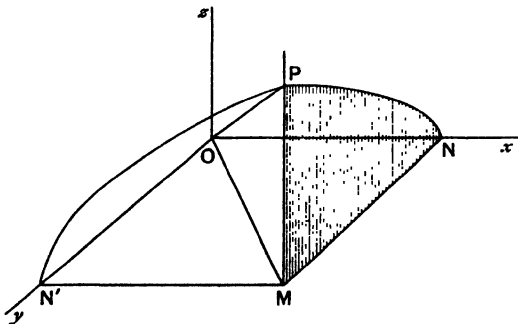

Fig. 550.

(Fig. 550) be a parabolic section by a plane parallel to the y - z plane bounded by the planes $x=y$, $z=0$. The volume, to $x=c$,

$$= \int_0^c \frac{2}{3} MN \cdot MP \, dON = \frac{2}{3} c^3.$$

The volume enclosed within the cube, $x = \pm c$, $y = \pm c$, $z = \pm c$, is $8 \cdot \frac{2}{3} \cdot c^3$; and the volume of the cube $= 8c^3$.

The representative point of a , b , h , viz. x , y , z must lie outside the cone but inside the cube, however large c may be.

Hence the chance required $= 1 - \frac{2}{3} = \frac{1}{3}$.

10. Six points are taken at hazard on the circumference of a circle. What is the chance that no two consecutive selected points are separated by more than a quadrant?

It will not affect the problem if we regard one of the points, viz. A , to be at a particular point of the circle. Let AC , BD be perpendicular diameters. Let the other five selected points be P_1 , P_2 , P_3 , P_4 and Q at arcual distances x_1 , x_2 , x_3 , x_4 and x respectively from A measured counter-clockwise. One of these five must be in each quadrant, and not more than two in any one quadrant. Let P_1 , P_2 , P_3 , P_4 be the points which lie in the first, second, third and fourth quadrants, and Q the one whose quadrant is unassigned. It will be sufficient to consider the two cases, (1) when Q lies in the first quadrant, (2) when Q lies in the second quadrant, for the number of cases when two lie in the fourth or third quadrants are the same as if two lie in the first or second respectively. Also when Q lies in the first or the second quadrant, we shall suppose that point of

the two which is nearer to A to be designated as Q . Let the length of a quadrantal arc = a . Then the two cases to consider are

(1) $x < x_1 < a$ and $a < x < x_2 < 2a$ (Figs. 551, 552).

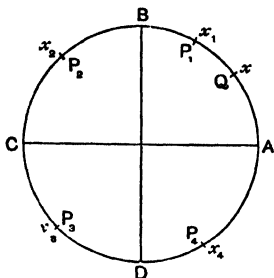

Fig. 551.

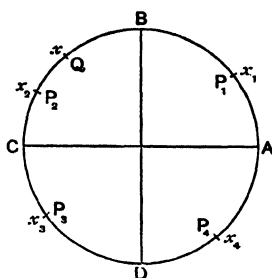

Fig. 552.

Then the chance required = $\frac{2N_1 + 2N_2}{D}$, where

$$N_1 = \int_0^a dx \int_x^a dx_1 \int_a^{a+x_1} dx_2 \int_{2a}^{a+x_2} dx_3 \int_{3a}^{a+x_3} dx_4;$$

$$N_2 = \int_0^a dx_1 \int_a^{a+x_1} dx \int_x^{2a} dx_2 \int_{2a}^{a+x_2} dx_3 \int_{3a}^{a+x_3} dx_4;$$

$$D = \int_0^{4a} dx_4 \int_0^{x_4} dx_3 \int_0^{x_3} dx_2 \int_0^{x_2} dx_1 \int_0^{x_1} dx.$$

The values of these integrals are readily shown to be $N_1 = 4a^5/5!$; $N_2 = 9a^5/5!$; $D = (4a)^5/5!$.

Hence the chance required = $\frac{26a^5/5!}{(4a)^5/5!} = \frac{13}{2^5}$.

11. Three random points L, M, N are taken within a circle of centre O and radius a . Find the chance that the circumcircle of LMN lies wholly within the original circle. [R. P.]

Let P be the centre and x the radius of the circumcircle, and $OP = r$. Take an arbitrary and indefinitely small strip of breadth k round the circumcircle. Its area = $2\pi xk$ to the first order. The chance that three random points should fall upon it = $\left(\frac{2\pi xk}{\pi a^2}\right)^3$, which we may write as $k^3 \frac{8x^3}{a^6} dx$. Integrating with regard to x from $x=0$ to $x=a-r$, which varies the size of this circle from radius zero to such a size that it will just not cut the original

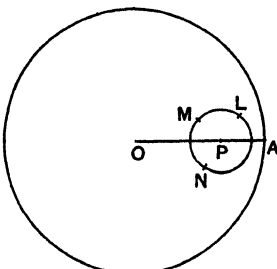

Fig. 553.

circle, we have $\frac{2k^3}{a^6} (a-r)^4$, where k^2 is an arbitrary elementary area at our

choice. We are now to sum up all such results as the above for various positions of P within the original circle. Replace k^2 by $r d\theta dr$, and integrate over the large circle.

$$\text{The required chance} = \frac{2}{a^6} \int_0^{2\pi} \int_0^a (a-r)^4 r d\theta dr = \frac{2\pi}{15}.$$

12. If $n+1$ particles P, Q, R, S, \dots be thrown down at hazard upon a straight line $OA (= a)$ each has the same chance of finding itself the $(r+1)^{\text{th}}$ in order reckoned from O towards A . Also, since some one of them must occupy the $(r+1)^{\text{th}}$ position, that chance is $1/(n+1)$. Examine this otherwise.

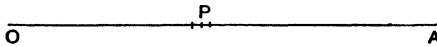

Fig. 554.

The composite chance that P falls at a distance from O lying between x and $x+dx$, and that r unspecified particles lie between O and P , and the rest between P and A , is ${}^nC_r \left(\frac{x}{a}\right)^r \left(\frac{a-x}{a}\right)^{n-r} \frac{dx}{a}$, and therefore the chance that P occupies the $(r+1)^{\text{th}}$ place irrespective of where it lies upon $OA = {}^nC_r \int_0^a x^r (a-x)^{n-r} dx / a^{n+1} = \text{etc.} = 1/(n+1)$.

13. Two points P and Q are selected at random within the volume of a right circular cone, and circular sections are drawn through them. What is the chance that the volume of the slice exceeds $1/8$ of the cone?

Take the vertex as the origin and the axis as x -axis, x and y the abscissae of the points and $y > x$. The chance that a random point has an abscissa lying between x and $x+dx$ is proportional to the volume of a slice of thickness dx , the abscissa of one of its faces being x , i.e. to $x^2 dx$. Also if a be the length of the axis, $y^3 - x^3 \leq \frac{1}{8} a^3$. The chance may then be written either as

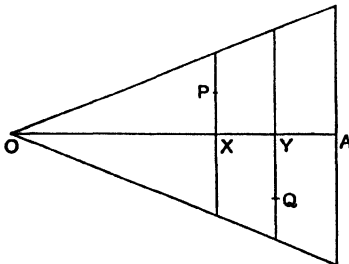

Fig. 555.

$$\frac{\int_0^{\frac{a}{2}\sqrt[3]{7}} x^2 dx \int_{\sqrt[3]{x^3 + \frac{1}{8}a^3}}^a y^2 dy}{\int_0^a x^2 dx \int_x^a y^2 dy};$$

or as

$$\frac{\int_{\frac{a}{2}}^a y^2 dy \int_0^{\sqrt[3]{y^3 - \frac{1}{8}a^3}} x^2 dx}{\int_0^a y^2 dy \int_0^y x^2 dx};$$

and each gives a result $49/64$.

The condensation curves (Art. 1692) for P -points and for Q -points, indicating the density of clustering on the x -axis of the ends of their abscissae, are

$$(i) \alpha^4 \eta = \xi^2 \left(\frac{1}{8} a^3 - \xi^3 \right) \quad \text{and} \quad (ii) \alpha^4 \eta = \xi^2 \left(\xi^3 - \frac{a^3}{8} \right).$$

Each touches the ξ -axis at the origin; (i) crosses the ξ -axis at $\frac{a}{2}\sqrt[3]{7}$, and has a maximum ordinate at $\xi = a\sqrt[3]{\frac{7}{20}} = a \times .70473\dots$; (ii) crosses the ξ -axis at $\frac{a}{2}$, has a minimum ordinate at $\xi = a\sqrt[3]{\frac{7}{20}}$, and η increases and is positive from $\frac{a}{2}$ to a . In Fig. 556 a is taken equal 2 units.

We are only concerned with the part of (i) from 0 to $\frac{a}{2}\sqrt[3]{7}$, and of (ii) from $\frac{a}{2}$ to a .

Both densities increase from $\frac{a}{2}$ to $a\sqrt[3]{\frac{7}{20}}$.

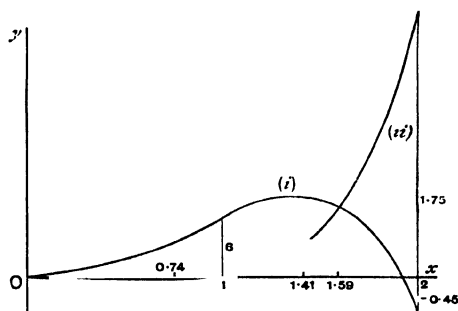

Fig. 556.

The first decreases and the second increases for the rest of the range.

If we require the chance that under the stated circumstances the point P possesses an abscissa lying between certain limits, say βa and αa , where $0 < \beta < \alpha < 1$, that chance is

$$C = \frac{\int_{\beta a}^{\alpha a} x^2 (\frac{1}{3} a^3 - x^3) dx}{\int_0^a x^2 (a^3 - x^3) dx} = (a^3 - \beta^3) (\frac{1}{3} - \alpha^3 - \beta^3).$$

It will be found that the chances that x lies between $\cdot 6a$ and $\cdot 7a$, or between $\cdot 7a$ and $\cdot 8a$, are respectively $\cdot 151257$ and $\cdot 151255$, and are almost exactly the same. This is in the immediate neighbourhood of max. condensation.

The point at which the condensation of the x -values reaches its maximum is $a\sqrt[3]{\frac{7}{20}} = a \times \cdot 70473$.

If γa be the "most probable value" of x , i.e. such that it is an even chance whether x exceeds or falls short of γa , it is given by

$$\gamma^3 (1 - \gamma^3) = \frac{1}{2} \cdot \frac{1}{3}, \quad \text{i.e. } \gamma = \frac{\sqrt[3]{7}}{2} \sqrt{1 - \frac{1}{\sqrt{2}}}.$$

The ordinate at this point bisects the portion of the area in the first quadrant of the condensation curve for P -points.

1696. **Inverse Probability.**

Questions involving the probability of causes as deduced from observed events are called questions on "inverse" probability. Supposing $P_1, P_2, \dots P_n$, the probabilities of the existence of the several causes of an event known to have happened, and that these causes are mutually exclusive, and that these are the only causes through which the event could have happened; and further, supposing that $p_1, p_2, \dots p_n$ are the respective probabilities that when the cause exists the event will follow, then it is known that in any case when the event has been observed to happen, the probability of its having done so from the r^{th} cause is $P_r p_r / \sum_1^n P_r p_r$ (Smith, *Alg.*, p. 521). This result is stated by Laplace [*Mém. sur la prob. des causes par les évènements, Mém. ... par divers savans*, T. vi., 1774].

If Q_r be the probability of the compound happening of the r^{th} cause followed by the event, $Q_r = P_r p_r$, and the above expression may be written $Q_r / \sum_1^n Q_r$.

1697. *Let the probability of the happening of a certain event A, which we may call the cause of a second event B, be x, which varies from 0 to 1. Let the happening of B depend upon the happening of A in such a manner that the compound probability of B's happening is $\phi(x)$. It is observed that B happens. What is the chance that x lies between two assigned limits β and α ? ($0 < \beta < \alpha < 1$.)*

Let OC denote unit length on the x -axis, and let the graph of $y = \phi(x)$ be drawn (Fig. 557). The ordinates represent the probability of B happening corresponding to the abscissa which represents that of A .

Let OC be divided into n equal elements of length h , $nh = 1$. The points of division are at distances from O , $0/n$, $1/n$, $2/n$, etc., and the probability of the existence of the r^{th} cause is

$$\phi\left(\frac{r}{n}\right) / \sum_0^n \phi\left(\frac{r}{n}\right), \quad \text{i.e. } \frac{1}{n} OC \phi\left(\frac{r}{n} OC\right) / \sum_{\frac{r}{n}=0}^{\frac{r}{n}=1} \frac{1}{n} OC \phi\left(\frac{r}{n} OC\right).$$

Hence the probability of the abscissa lying between α and

$x+dx$ is $\phi(x)dx / \int_0^1 \phi(x)dx$; and therefore the chance that the abscissa lies between β and a is $\int_\beta^a \phi(x)dx / \int_0^1 \phi(x)dx$.

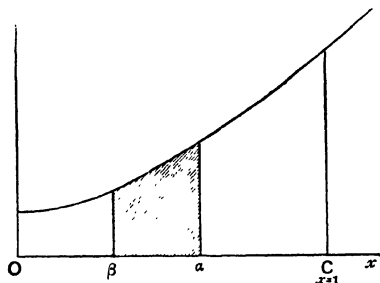

Fig. 557.

This chance is therefore measured by the ratio of the area bounded by the curve and the x -axis comprised between the ordinates $x=\beta$ and $x=a$ to that comprised between $x=0$ and $x=1$.

1698. In the same way, if the secondary event B be dependent upon two (or more) primary events A_1, A_2 , whose probabilities are represented by x_1, x_2 , whilst that of the dependent secondary event is $\phi(x_1, x_2)$, the chance that the probabilities of these primary events respectively lie between β_1 and a_1, β_2 and a_2 , where $0 < \beta_1 < a_1 < 1$ and $0 < \beta_2 < a_2 < 1$, is

$$\int_{\beta_1}^{a_1} \int_{\beta_2}^{a_2} \phi(x_1, x_2) dx_1 dx_2 / \int_0^1 \int_0^1 \phi(x_1, x_2) dx_1 dx_2,$$

with corresponding expressions if there be more than two variables.

1699. Recurring to Ex. 12, Art. 1695, we have seen that if a point X be taken at random on a line $OA=a$, and then $m+n$ other points be taken at random on the same line, the chance that m unspecified points of the group lie between O and X and the remainder between X and A is

$${}^{m+n}C_m \int_0^a \left(\frac{x}{a}\right)^m \left(\frac{a-x}{a}\right)^n \frac{dx}{a} = \frac{1}{m+n+1},$$

a fact obvious from another consideration as pointed out. We may use this problem to illustrate the result obtained in

Art. 1697. The fact that X lies at a distance x from O may be regarded as a primary event or cause from which the nature of the secondary event, viz. the particular allocation of the $m+n$ unspecified points, arises; and the chance of the happening of the secondary event is a function of the variable x which defines the cause.

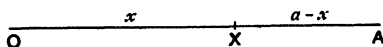

Fig. 558.

The total number of ways in which it can happen that whilst X lies between an unassigned x and $x+dx$, an unspecified m of the $m+n$ random points lie on OX and the remainder on XA for all values of x from 0 to a is measured by

$${}^{m+n}C_m a^{m+n+1} \int_0^a \left(\frac{x}{a}\right)^m \left(\frac{a-x}{a}\right)^n \frac{dx}{a};$$

and the number of ways the same thing can happen when X lies between an assigned x and $x+dx$ is measured by

$${}^{m+n}C_m a^{m+n+1} \left(\frac{x}{a}\right)^m \left(\frac{a-x}{a}\right)^n \frac{dx}{a}.$$

Therefore, when the compound event happens, the chance that x lies between x and $x+dx$ is the ratio of the second of these expressions to the first, i.e. $x^m(a-x)^n dx / \int_0^a x^m(a-x)^n dx$.

And the chance that when the compound event happens, X will lie between $x=\beta$ and $x=a$, ($0 < \beta < a < a$) is

$$\int_\beta^a x^m(a-x)^n dx / \int_0^a x^m(a-x)^n dx.$$

1700. Next suppose that a new group of $p+q$ random points is taken upon the line OA . What is the chance that an unspecified p of these points also lie between O and X and the remainder between X and A ?

The total number of such cases when X falls between x and $x+dx$ will be

$${}^{m+n}C_m {}^{p+q}C_p a^{m+n+p+q+1} \left(\frac{x}{a}\right)^m \left(\frac{a-x}{a}\right)^n \left(\frac{x}{a}\right)^p \left(\frac{a-x}{a}\right)^q \frac{dx}{a},$$

and the total number of cases for all positions of X , in which m unspecified points of the $m+n$ lie on OX , whilst the other

n lie on XA , whilst the $p+q$ points are distributed anywhere on the line, is ${}^{m+n}C_n a^{m+n+1} a^{p+q} \int_0^a \left(\frac{x}{a}\right)^m \left(\frac{a-x}{a}\right)^n \frac{dx}{a}$.

Therefore the compound chance that (i) X lies between x and $x+dx$; (ii) m unspecified members of the first group fall on OX and the other n on XA ; (iii) that p unspecified members of the second group fall on OX and the other q on XA , is

$$\frac{{}^{p+q}C_p x^{m+p}(a-x)^{n+q} dx}{a^{p+q} \int_0^a x^m(a-x)^n dx}.$$

Hence the whole probability that this compound event happens when X lies anywhere on OA is

$$\frac{{}^{p+q}C_p \int_0^a x^{m+p}(a-x)^{n+q} dx}{a^{p+q} \int_0^a x^m(a-x)^n dx} = \frac{(p+q)!}{p!q!} \frac{(m+p)!(n+q)!}{(m+n+p+q+1)!} \frac{(m+n+1)!}{m!n!}.$$

1701. The above problem forms a landmark in the History of Probability. It is associated with the names of many investigators, Bayes, Condorcet, Trembley, Laplace and others. (See Todhunter's *History*, pages 295, 383, 399, 414, 467, etc.)

It is often enunciated in a different way.

An urn is supposed to contain an infinite number of white tickets and an infinite number of black tickets, and no others, and that is all that is supposed to be known as to the tickets. These tickets correspond to possible situations of a point to the left of X or to the right of X in the foregoing problem. Then $m+n$ tickets having been drawn from the urn, m are found to be white and the remainder black. What is the probability that a further drawing of $p+q$ tickets will result in p being white and q black?

Laplace gives the required result as
$$\frac{\int_0^1 x^{m+p}(1-x)^{n+q} dx}{\int_0^1 x^m(1-x)^n dx},$$

which, without the factor $(p+q)!/p!q!$, supposes the tickets to have been drawn in a specific order. Todhunter quotes the following remark of Laplace: "La solution de ce problème donne une méthode directe pour déterminer la probabilité des évènements futurs d'après ceux qui sont déjà arrivés."

1702. Next suppose that on the line OA ($=a$) several random points X_1, X_2, \dots, X_{n-1} be taken at distances x_1, x_2, \dots, x_{n-1}

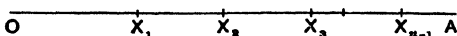

Fig. 559.

from O , in this order, and let $p_1 + p_2 + \dots + p_n$ other random points be taken upon OA . Then the compound chance that (i) X_1 lies between x_1 and $x_1 + dx_1$, X_2 between x_2 and $x_2 + dx_2$, etc.; (ii) p_1 specified points fall on OX_1 , p_2 on X_1X_2 , p_3 on X_2X_3 , etc., is

$$\left(\frac{x_1}{a}\right)^{p_1} \left(\frac{x_2 - x_1}{a}\right)^{p_2} \dots \left(\frac{a - x_{n-1}}{a}\right)^{p_n} \cdot \frac{dx_1}{a} \cdot \frac{dx_2}{a} \dots \frac{dx_{n-1}}{a}.$$

Hence, for *unspecified* groups of p_1 points between O and X_1 , p_2 between X_1 and X_2 , etc., whilst X_1, X_2, \dots, X_{n-1} lie at any points of OA , in this order, the chance is

$$\frac{(p_1 + p_2 + \dots + p_n)!}{p_1! p_2! \dots p_n!} \int_0^a \int_0^{x_{n-1}} \int_0^{x_{n-2}} \dots \int_0^{x_1} \left(\frac{x_1}{a}\right)^{p_1} \left(\frac{x_2 - x_1}{a}\right)^{p_2} \dots$$

$$\times \left(\frac{a - x_{n-1}}{a}\right)^{p_n} \frac{dx_{n-1}}{a} \frac{dx_{n-2}}{a} \dots \frac{dx_2}{a} \cdot \frac{dx_1}{a},$$

which at once reduces to $1/(\Sigma p + 1)(\Sigma p + 2) \dots (\Sigma p + n - 1)$. And this is an obvious result. For of the $p_1 + p_2 + \dots + p_n + n - 1$ points of division, the chance of the $n - 1$ points standing in the specified order in the $(p_1 + 1)^{\text{th}}$, $(p_1 + p_2 + 2)^{\text{th}}$, etc., positions is clearly

$$\frac{(p_1 + p_2 + \dots + p_n)!}{(p_1 + p_2 + \dots + n - 1)!}$$

$$= 1/(\Sigma p + 1)(\Sigma p + 2) \dots (\Sigma p + n - 1).$$

If now another group of $q_1 + q_2 + \dots + q_n$ points be chosen at random on OA , the chance that q_1 unspecified ones shall lie in the same segment as the p_1 points, q_2 in the same segment as the p_2 , and so on, will be

$$\frac{1}{a^{q_1 + \dots + q_n}} \frac{(q_1 + q_2 + \dots + q_n)!}{q_1! q_2! \dots q_n!}$$

$$\times \frac{\int \dots \int x_1^{p_1 + q_1} (x_2 - x_1)^{p_2 + q_2} \dots (a - x_{n-1})^{p_n + q_n} dx_{n-1} dx_{n-2} \dots dx_1}{\int \dots \int x_1^{p_1} (x_2 - x_1)^{p_2} \dots (a - x_{n-1})^{p_n} dx_{n-1} dx_{n-2} \dots dx_1},$$

the limits for x_1 being 0 to x_2 ; for x_2 , 0 to x_3 , etc.; for x_{n-1} , 0 to a , which we may evaluate as before.

1703. Ex. *From a bag containing an infinite number of tickets, each of which is known to be black or white, ten are drawn at random, and found to be four white, six black. What is the chance that a further draw of two tickets gives one white, one black?*

Here $m = 4$, $n = 6$, $p = 1$, $q = 1$, $a = 1$, and the chance required

$$= {}^2C_1 \int_0^1 x^6(1-x)^4 dx / \int_0^1 x^4(1-x)^6 dx = \frac{2\Gamma(6)\Gamma(8)}{\Gamma(14)} \cdot \frac{\Gamma(12)}{\Gamma(5)\Gamma(7)} = \frac{35}{78}.$$

What would be the chance that a draw of one ticket only should yield a white one, and that a subsequent draw should yield a black one?

The chance for a white one at the next draw

$$= \int_0^1 x^6(1-x)^6 dx / \int_0^1 x^4(1-x)^6 dx = \frac{5}{12}.$$

The chance for a black to follow = $\int_0^1 x^6(1-x)^2 dx / \int_0^1 x^6(1-x)^6 dx = \frac{7}{13}$.

The chance for the two draws to result in this order = $\frac{5}{12} \cdot \frac{7}{13} = \frac{35}{156}$.

The chance that x , which represents the proportion of the number of white tickets to the whole number of tickets in the bag, should be more than $\frac{1}{2}$ of the whole is $\int_{\frac{1}{2}}^1 x^4(1-x)^6 dx / \int_0^1 x^4(1-x)^6 dx = 281/2^{10}$.

1704. Buffon's Problem. Parallel Rulings.

An infinite plane is ruled by an infinite system of equidistant parallel lines, whose distances apart = $2a$. A thin rod of length $2l$ ($< 2a$) is thrown at random upon the plane. What is the chance that the rod will cut one of the parallels?

Take as y -axis that one of the parallels to which the centre C of the rod falls nearest, and the x -axis perpendicular to the set. The problem is unaffected if we suppose the centre of the rod to fall upon the x -axis, for the proportion of the number of cases in which the rod cuts one of the rulings to the whole number of possible cases is not altered thereby.

Let O be the origin, $OC = x$. Let the figure represent the case in which one end of the rod lies upon the y -axis, the angle between the rod and CO being ϕ . Then $x = l \cos \phi$. Then for a given position of C , the chance of a cut

$$= 2 \cdot \frac{2\phi}{2\pi} = \frac{2}{\pi} \cos^{-1} \frac{x}{l};$$

and the chance that C lies between x and $x + dx$ on a line of

length a is dx/a , and when C falls between $x=l$ and $x=a$, there is no chance of a cut. Hence the whole chance required is

$$\frac{2}{\pi a} \int_0^l \cos^{-1} \frac{x}{l} dx = \frac{2l}{\pi a} \int_0^{\frac{\pi}{2}} \phi \sin \phi d\phi = \frac{2l}{\pi a} = \frac{\text{double the length of the rod}}{\text{circ. of a circle of radius } a}.$$

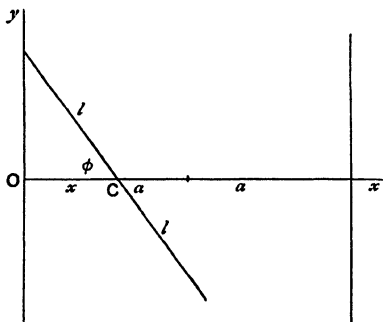

Fig. 560.

This is a particular case of a remarkable general result to be seen later. It is another landmark in the history of the subject. It was given by the naturalist Buffon in his *Essai d'Arithmétique Morale*, 1777. Also see Laplace, *Théorie de Prob.*, p. 359 (Todhunter, *History*).

1705. Rectangular Rulings.

Suppose a second system of parallel lines drawn at right angles to the former set, whose distances apart $=2b$ ($> 2l$), thus mapping out the infinite plane into a net-work of equal parallelograms. Consider that rectangle formed by a consecutive pair of each family of rulings which finds itself the recipient of the centre of the rod. Suppose the rod to have come to rest, making an angle ϕ with the side of length $2a$. If we join the centres of the extreme positions of the rod at this inclination, an inner rectangle is formed of sides $2a - 2l \cos \phi$, $2b - 2l \sin \phi$, and no rod at this inclination, whose centre falls within this rectangle, can cut a side of the mesh, whilst those whose centres fall without it do so. Taking axes coincident with two sides of the rectangle, the angular position of the rod may range from being parallel to the x -axis to being perpendicular to it. The chance that the inclination lies between ϕ and $\phi + d\phi$ is proportional to $d\phi$, and we are

to evaluate the ratio of $\iiint \frac{dx}{a} \frac{dy}{b} d\phi$ for the favourable cases to the same integral for the whole number of cases. The integration for x and for y has been effected geometrically above.

The chance required is therefore

$$\left[\int_0^{\frac{\pi}{2}} \{2a \cdot 2b - (2a - 2l \cos \phi)(2b - 2l \sin \phi)\} d\phi \right] / \int_0^{\frac{\pi}{2}} 4ab d\phi$$

$$= \frac{2l}{\pi ab} \int_0^{\frac{\pi}{2}} (a \sin \phi + b \cos \phi - l \sin \phi \cos \phi) d\phi = \frac{l}{\pi ab} (2a + 2b - l).$$

Buffon's result $2l/\pi a$ follows at once by making b infinite.

Putting $a=b$, the result is $l(4a-l)/\pi a^2$ for square meshes.

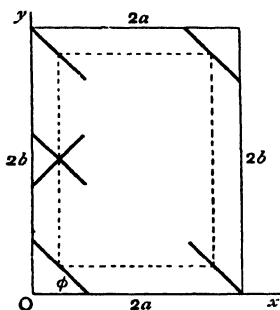

Fig. 561.

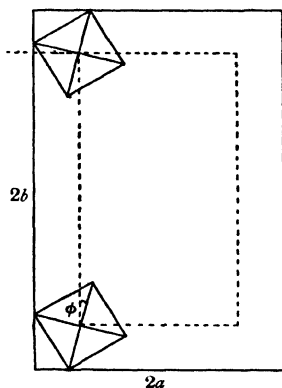

Fig. 562.

1706. Suppose a square of diagonal $2l$ to be thrown upon the above rectangular mesh-work, l being less than either a or b , and let the inclination of a diagonal to the side of length $2b$ be ϕ .

To avoid a cut, the centre of the square must lie within an inner rectangle of area $4(a - l \cos \phi)(b - l \sin \phi)$. The range for ϕ is from 0 to $\frac{\pi}{4}$, and the result $= \frac{l}{2\pi ab} \{4(a+b)\sqrt{2} - (\pi+2)l\}$.

If $b = \infty$, this becomes $\frac{\text{perimeter of square}}{\text{circumf. of circle of rad. } a}$. (See Art. 1707.)

If a circular lamina of radius r ($< a$ or b) be thrown at hazard in the same way, the chance of a cut is obviously

$$\frac{2a \cdot 2b - (2a - 2r)(2b - 2r)}{2a \cdot 2b} = \frac{r(a+b-r)}{ab}.$$

And when b becomes ∞ this becomes $\frac{\text{circumf. of circle of rad. } r}{\text{circumf. of circle of rad. } a}$.

This class of problem leads us to enquire as to the chance of a hazard throw of a lamina of any shape cutting one of a system of equidistant parallels drawn upon a plane. This we proceed to consider.

1707. RANDOM LINES.

Let an infinite plane be ruled by parallel lines at distances apart $=2a$. Let n equal short lines of lengths δs , whether in rigid connection or not is immaterial, be thrown down at hazard upon the plane so ruled. Then each one has an equal chance of finding itself crossing one of the rulings. If p be that chance, the chance that some one of them crosses a ruling $=np$.

Suppose that the n elementary lines δs are the infinitesimal elements of the perimeter of some oval of perimeter s . Then $n \delta s = s$, n being infinitely great. The chance of the perimeter of the curve cutting one of the rulings is therefore $\frac{p}{\delta s} s$, that is λs , where λ is the limit of $p/\delta s$ when δs is infinitesimally small. Next consider the case of a circle of radius a . If this be thrown at hazard upon the plane, it is a certainty that it must cut one of the rulings, and only one. Hence $\lambda 2\pi a = 1$. This determines λ .

Thus the chance of a curve of perimeter s , whose greatest breadth does not exceed $2a$, cutting a ruling is $s/2\pi a$. Curves therefore of the same perimeter, and whose greatest breadths do not exceed $2a$, have equal chances of cutting a ruling.

1708. Examples.

1. If a circle of radius b ($< a$) be thrown down at hazard upon the plane, the chance of crossing a ruling $= 2\pi b/2\pi a = b/a$.

2. If the contour be a square of side b ($< a\sqrt{2}$), the chance is $2b/\pi a$.

3. If the "curve" thrown down be a straight line of length $2l$ ($< 2a$), it may be considered as an ellipse of minor axis zero and perimeter $4l$, and the chance is $2l/\pi a$ (Art. 1704).

4. For a semicircle of radius b ($< a$), the chance is $(\pi + 2)b/2\pi a$.

1709. Let O be a point fixed to the contour thrown down, and OA a fixed axis on it.

Let O fall at a distance p from one of the rulings, RS , and let OA make an angle ψ with the perpendicular p . Let this contour be thrown down at random upon the ruled plane a very large number of times, and let the trace of the rulings

be marked at each throw upon the plane of the contour. Now it is immaterial whether we regard the contour as thrown down at hazard upon the ruled plane, or the ruled plane thrown at hazard upon the plane containing the contour. Take the latter case. Let a doubly infinite number of lines be drawn upon the plane of the contour according to the following plan :

(a) Let the lines be drawn parallel to a standard line

$$p = x \cos \psi + y \sin \psi,$$

which we may call the line (p, ψ) , at equal distances apart, such that

n of them are contained between the lines (p, ψ) and $(p + \delta p, \psi)$.

(b) Let us suppose drawn for *each* value of $p, p + \delta p$, etc., the infinite family of lines $\psi, \psi + \delta\psi, \psi + 2\delta\psi$, etc., there being m lines with the same value of p between (p, ψ) and $(p, \psi + \delta\psi)$, viz. those for which \hat{p} makes with OA angles

$$\psi + \frac{1}{m} \delta\psi, \quad \psi + \frac{2}{m} \delta\psi, \dots \psi + \delta\psi.$$

We shall define any line chosen at random from this double set for equal gradations of p and of ψ as a "random line."

The actual number of lines from (p, ψ) to $(p + \delta p, \psi + \delta\psi)$ is mn , and we obtain in this way the same system of lines as those obtained by the tracings of the rulings upon the plane of the contour after the contour plane is thrown down at hazard upon the ruled plane.

Taking the case of a circle of radius a and centre O , the number of such lines crossing it is

$$mn \int_0^a \int_0^{2\pi} dp d\psi = mn \cdot 2\pi a \equiv \lambda, \text{ say.}$$

Hence the number from (p, ψ) to $p + \delta p, \psi + \delta\psi$, viz. $mn \delta p \delta\psi$,

$$\text{is } \frac{\lambda}{2\pi a} \delta p \delta\psi.$$

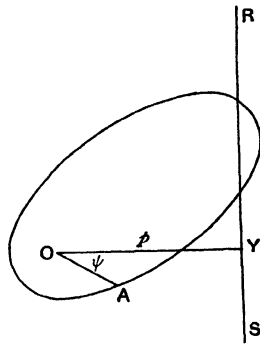

Fig. 563.

Now, if O be a point within any closed convex contour,

$$\iint dp d\psi = \int p d\psi = \text{perimeter.}$$

Hence the number of lines crossing such a closed convex contour $= \frac{\lambda}{2\pi a} \times \text{perimeter, i.e.}$

$$\frac{\text{No. of lines crossing any closed convex contour}}{\text{No. of lines crossing a circle of radius } a} = \frac{\text{perim. of curve}}{\text{perim. of circle}}$$

The length of the perimeter therefore measures the number of lines crossing the contour.

This is the same result as that of Art. 1707, from a different point of view.

1710. If there be any re-entrant portion of the contour, the perimeter must be regarded as the length of a stretched elastic band which encircles it; that is, the re-entrant portions must be excluded by double tangents. Otherwise some of the random chords will be counted more than once by the above rule.

1711. Examples.

1. If a closed convex contour of perimeter Σ completely encloses a second closed convex contour of perimeter S , the number of chords of the outer which cut the inner is $\lambda S/2\pi a$. And the total number of chords of the outer is $\lambda \Sigma/2\pi a$. Therefore the chance of a chord of the outer cutting the inner also is S/Σ .

If the outer be a circle of radius R , and the inner a square of side b , the chance is $2b/\pi R$.

2. If the inner degenerates into a straight line of length $2l$, and the outer be a circle of radius R , the chance is $4l/2\pi R = 2l/\pi R$.

3. The chance that a random chord of a circle cuts a given diameter is $2/\pi$.

1712. We may then speak of S or $\iint dp d\psi$ as "the number of lines" which cross any convex contour throughout which the integration is conducted, whenever a comparison is to be instituted between the number of lines which cut one convex contour with the number which cut another.

1713. Various Cases.

In the case of a straight line of length c , which is the limit of an ellipse of zero minor axis and perimeter $2c$, the number of random lines cutting it is then measured by $2c$.

1714. In the case of an arc of length s bounded by a chord of length c , there being no re-entrant portion, the number of random chords crossing the contour is measured by $s+c$. But the number which cross c is $2c$.

Hence the number which cross s twice and do not cut c is $s-c$.

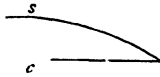

Fig. 564.

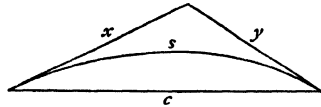

Fig. 565.

1715. In the case of the contour bounded by an arc s and a pair of tangents of lengths x and y , let c be the length of the chord; then, if s be concave at each point to the foot of the perpendicular upon the chord,

the number of random lines which cut x and y , but not c , is $x+y-c$;

the number which cut s , but not c , is $s-c$.

Therefore the number which cut x and y , but not s , is $x+y-s$.

1716. In the case of two arcs s_1, s_2 and a chord c , each arc being convex at every point to the foot of the perpendicular upon the chord, as in Fig. 566; let c_1, c_2 be the chords of the arcs s_1, s_2 respectively.

Then the number of chords cutting c_1, c_2 , but not c , $=c_1+c_2-c$. These necessarily all cut s_1 and s_2 , each once only.

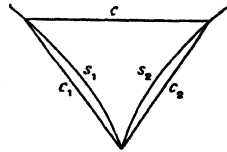

Fig. 566.

The number of those which cut s_1 twice, but not c_1 , $=s_1-c_1$.

These also cut s_2 once and c once.

The number of those which cut s_2 twice, but not c_2 , $=s_2-c_2$.

These also cut s_1 once and c once.

Hence the number which cut both s_1 and s_2

$$=(c_1+c_2-c)+(s_1-c_1)+(s_2-c_2)=s_1+s_2-c.$$

1717. In the case where the region considered is bounded by three arcs s_1, s_2, s_3 , lying within the chordal triangle c_1, c_2, c_3 , and each concave at all points to the foot of the

ordinate from the point to the chord of the arc (Fig. 567), the number of chords cutting s_1 , but not c_1 , $=s_1 - c_1$. These necessarily cut s_2 and s_3 , c_2 and c_3 .

The number of chords cutting one or other of the three arcs twice, and therefore cutting all three arcs,

$$=(s_1 - c_1) + (s_2 - c_2) + (s_3 - c_3).$$

The number which cut s_2 and $s_3 = s_2 + s_3 - c_1$.

Therefore the number which cut s_2 and s_3 , but not s_1 ,

$$=(s_2 + s_3 - c_1) - (s_1 - c_1) = s_2 + s_3 - s_1.$$

Therefore the number which cut any two of the arcs, but not the third, is

$$(s_2 + s_3 - s_1) + (s_3 + s_1 - s_2) + (s_1 + s_2 - s_3) = s_1 + s_2 + s_3.$$

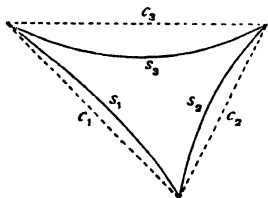

Fig. 567.

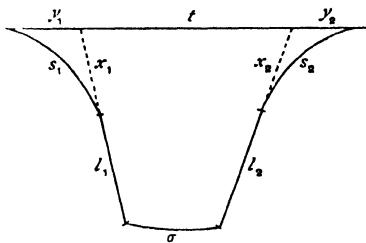

Fig. 568.

1718. Consider the case of a region bounded by such a combination of arcs and lines as exhibited in Fig. 568, where t is a chord or a double tangent; s_1, s_2 any arcs convex at each point throughout their lengths to the foot of the ordinate to t ; l_1, l_2 straight lines tangential to s_1 and s_2 , and σ an arc concave at each point to the foot of the ordinate drawn upon its own chord, which lies within the region considered, and either touching l_1 and l_2 or meeting them and lying between l_1 and l_2 produced.

The number of lines crossing this contour, but which do not cut t , with the exception of such as meet $s_1 + l_1$ or $s_2 + l_2$ twice and incidentally meet t , is

$$\{x_1 + l_1 + \sigma + l_2 + x_2 - (t - y_1 - y_2)\} - (x_1 + y_1 - s_1) - (x_2 + y_2 - s_2),$$

where the meanings of the various letters are indicated in the figure. For the first bracket includes those which cut $x_1 + l_1$, y_1 , but not $s_1 + l_1$; or $x_2 + l_2$, y_2 , and not $s_2 + l_2$, the number of

which cases is subtracted in the second and third brackets. The expression reduces to $s_1 + s_2 + l_1 + l_2 + \sigma - t$.

1719. In the case of two non-intersecting non-re-entrant ovals A and B , of perimeters P_A, P_B , external to each other, let the lengths of the several arcs and tangents be as indicated in Fig. 569. Let β_c and β_u be the stretched lengths of the crossed and uncrossed elastic belts surrounding the ovals. Random chords crossing both ovals must either

(i) cross the region $s_1 x_1 x_2 \sigma_1 T_1$, and except for those which cross $s_1 + x_1$ or $\sigma_1 + x_2$ twice, not cross T_1 ; or

(ii) cross the region $s_3 y_1 y_2 \sigma_3 T_2$, and except for those which cross $s_3 + y_1$ or $\sigma_3 + y_2$ twice, not cross T_2 .

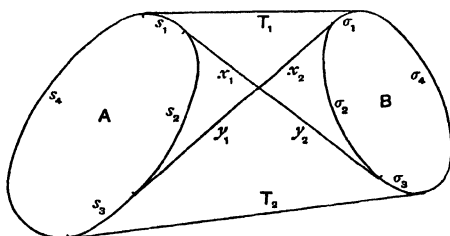

Fig. 569.

Their number is therefore

$$(s_1 + x_1 + x_2 + \sigma_1 - T_1) + (s_3 + y_1 + y_2 + \sigma_3 - T_2) = \beta_c - \beta_u,$$

i.e. the difference of the crossed and uncrossed belts. Hence the probabilities that a random chord of A crosses B , or that a random chord of B crosses A , are respectively $(\beta_c - \beta_u)/P_A$ and $(\beta_c - \beta_u)/P_B$.

1720. If the ovals touch externally $\beta_c = P_A + P_B$.

1721. If the ovals intersect, indicate the several arcs and tangents as in Fig. 570.

The chords which cut both may be classified as

(i) those crossing s_1 and σ_1 , but which, with the exception of those cutting s_1 twice or σ_1 twice, do not cut T_1 ;

(ii) those crossing s_2 and σ_2 , but which, with the exception of those cutting s_2 twice or σ_2 twice, do not cut T_2 ;

(iii) those which cut the region bounded by s_3 and σ_3 .

Their number is therefore

$$(s_1 + \sigma_1 - T_1) + (s_3 + \sigma_3) + (s_2 + \sigma_2 - T_2) = P_A + P_B - \beta_u,$$

i.e. the sum of the perimeters less by the belt.

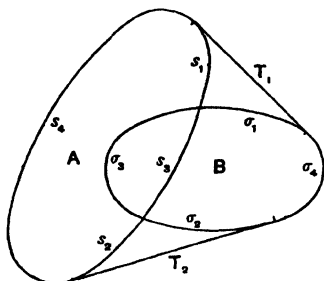

Fig. 570.

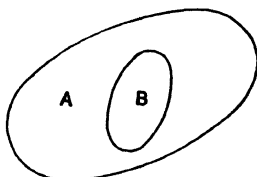

Fig. 571.

1722. If one oval B lie entirely within the other one A , every random chord of B is a chord of A . The number of chords which cut both is therefore P_B .

1723. If a third non-re-entrant oval X lie partly between A and B and be cut by the uncrossed belt, but not by the crossed belt, as shown in Fig. 572, we shall consider how many random lines can be drawn cutting all three contours, it being understood that the ovals are so situated that for all chords cutting all three the X -segment is intermediate between the other two.

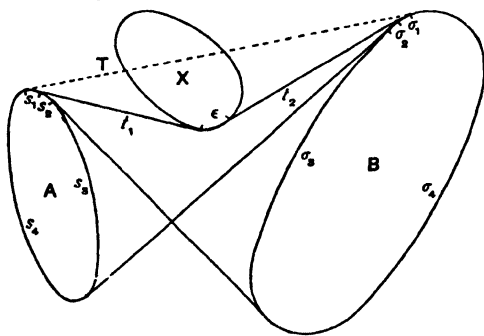

Fig. 572.

Indicating the lengths of the several arcs and tangents as in Fig. 572, all such random lines as are chords of all these regions must be chords of the region $(s_1, t_1, \epsilon, t_2, \sigma_1, T)$, but must not cross T , with the exception of those which cross $s_1 + t_1$ twice or

σ_1+t_2 twice, with an incidental crossing of T . By Art. 1718 their number is $s_1+t_1+\epsilon+t_2+\sigma_1-T$; *i.e.* the amount by which the uncrossed belt has been lengthened by X having been pushed into position from outside the belt.

1724. If in the last case the oval X has been pushed completely within the region bounded by the uncrossed belt, but still not so as to cut the crossed one, denote the various lengths of arcs and lines as in Fig. 573.

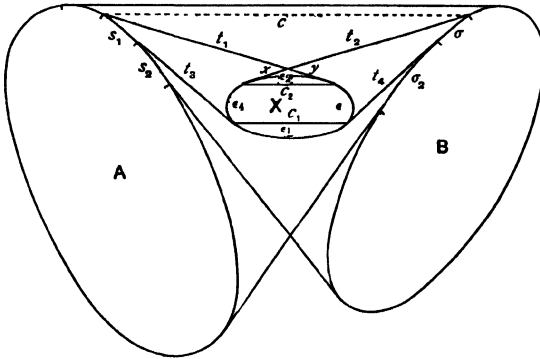

Fig. 573.

Then the number of random lines which cut all three ovals is $\alpha-\beta-\gamma+\delta$, where

(i) α is the number which cut the contour $(s_1t_3\epsilon_1t_4\sigma_1c)$, but do not cut c , with the exception of those which cut s_1+t_3 or σ_1+t_4 twice, $=s_1+t_3+\epsilon_1+t_4+\sigma_1-c$;

(ii) β is the number which cut (t_1-y, t_2-x, c) , but do not cut c , $=t_1-y+t_2-x-c$;

(iii) γ is the number which cut (x, y, c_2) , but not c_2 , $=x+y-c_2$;



Fig. 574.

(iv) δ is the number which cut ϵ_2 twice, but not c_2 , $=\epsilon_2-c_2$.

The total, after rearranging, is

$$(s_1+t_3+\epsilon_1+\epsilon_3+\epsilon_2+\epsilon_4+\epsilon_1+t_4+\sigma_1)-(t_1+\epsilon_3+\epsilon_1+\epsilon_4+t_2),$$

which is the difference of the increases of length of the uncrossed belt caused by its being made to pass round the contour of X in opposite directions (Fig. 574).

1725. In a similar manner it is easy to examine other special cases. The last two results are due to Sylvester [*Educ. Times*], who refers for simpler cases to Czuber's *Geometrische Wahrscheinlichkeiten*.

1726. **Ex.** Three pennies of diameters d are soldered together in mutual contact at their edges.

This figure is thrown upon a table ruled with parallel lines at equal distances ($2a$) apart ($a > d$). What is the chance of 2, 4 or 6 intersections?

[BIDDLE'S PROBLEM.]

Let the discs be labelled A, B, C .

Let the number of chords which cut

(i) A alone, (ii) A and B , but not C , and (iii) all three be respectively $x, y, 3z$. Then

$$3x + 3y + 3z = \text{length of surrounding belt} = (\pi + 3)d,$$

$$3z = 3 \times \text{lengthening of an uncrossed belt round } A \text{ and } B \\ \text{by pushing } C \text{ into position}$$

$$= 3\left(\frac{2\pi d}{3} - d\right) = (\pi - 3)d,$$

$$y = (\text{crossed belt round } A, B - \text{uncrossed belt}) - 3z \\ = (\pi - 2)d - (\pi - 3)d = d.$$

Hence $x = y = d$, $z = (\pi - 3)d/3$.

Therefore the chances required are respectively

$$3d/2\pi a, \quad 3d/2\pi a, \quad (\pi - 3)d/2\pi a.$$

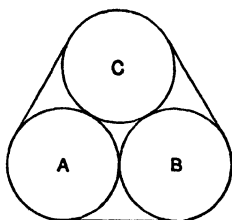

Fig. 575.

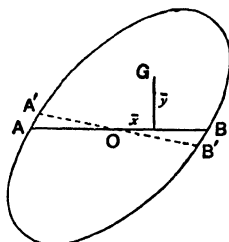

Fig. 576.

1727. Crofton's Theorem.

In any centric convex contour of area A , let AB be a diameter and G the centroid of the area of either semi-oval. Let P be the perimeter of the path of G as AB rotates; then the mean radial distance of any point within the contour from the centre O is $\frac{1}{4}P$.

If \bar{x}, \bar{y} be the coordinates of G referred to OB as x -axis, W the weight of the half oval, $AB = 2r$, and if we place two

small weights w and $-w$ at distances $\frac{2}{3}OB$ and $\frac{2}{3}OA$ from O , the new coordinates of G will be

$$\bar{x} + d\bar{x} = \left\{ W\bar{x} + w \cdot \frac{2}{3}r + (-w) \left(-\frac{2}{3}r \right) \right\} / W = \bar{x} + \frac{4}{3} \frac{w}{W} r;$$

$$\bar{y} + d\bar{y} = (W\bar{y} + 0) / W = \bar{y}.$$

Hence
$$d\bar{x} = \frac{4}{3} \frac{w}{W} r, \quad d\bar{y} = 0.$$

The centroid has therefore been moved parallel to AB . The effect upon G is the same as the above, if AB rotate through a small infinitesimal angle $d\psi$ to a contiguous position $A'OB'$, and then w is the weight of the sector $= \frac{1}{2}r^2 d\psi$, and

$$W = \int_0^\pi \frac{1}{2}r^2 d\psi = \frac{1}{2}A,$$

and $d\bar{x}$ is an element of the arc of the G -path $= ds$. Hence the intrinsic equation of the G -path is $ds = \frac{4}{3} \frac{r^3}{A} d\psi$, and its radius

of curvature $= \frac{1}{6} \frac{(\text{Chord } AB)^3}{\text{Area of oval}}$ and $P = \frac{1}{6A} \int_0^{2\pi} (\text{Chord})^3 d\psi$.

Again
$$M(r) = \frac{\iint r(r d\psi dr)}{\iint r d\psi dr} = \frac{1}{A} \iint r^2 d\psi dr = \frac{1}{24A} \int_0^{2\pi} (\text{Chord})^3 d\psi = \frac{1}{4}P.$$

Prof. Crofton's proof of this result [*Proc. Lond. Math. Soc.*, viii.] runs on different lines, but he indicates the above as a method of procedure.

1728. Useful Results for a Convex Contour of Area A and Perimeter L .

Let C be the length of a chord, coordinates (p, ψ) , with regard to an origin O within the oval, G the centroid of the oval, OG ($=c$) the initial line from which ψ is measured, $O\xi$ a line parallel to the chord, \bar{p} the perpendicular from G upon $O\xi$; p_1 and p_2 the perpendiculars upon the tangents parallel to the chord. Then we have, taking limits from $-p_1$ to p_2 ,

(i) $\int C dp = A$; (ii) $\int pC dp = A\bar{p}$; (iii) $\int p^2 C dp = A\bar{p}^2 + Ak^2$,

where Ak^2 is the moment of inertia about a parallel through G .

Hence integrating (i) and (ii) with regard to ψ from 0 to π , which takes in all random chords,

$$(i) \iint C dp d\psi = \int A d\psi = \pi A; \text{ whence}$$

$$M(\text{Chord}) = \frac{\iint C dp d\psi}{\iint dp d\psi} = \pi \cdot \frac{\text{Area of contour}}{\text{Perimeter}};$$

$$(ii) \iint pC dp d\psi = \int A\bar{p} d\psi = Ac \int \sin \psi d\psi = 2Ac, \text{ and in this}$$

integration it is to be noted that p changes sign as C passes through the origin.

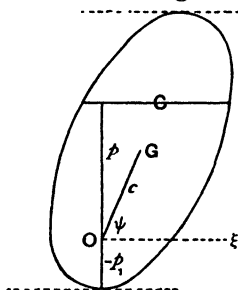

Fig. 577.

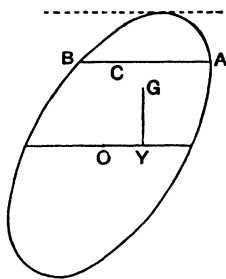

Fig. 578.

If the oval be centric and the origin be taken at the centre, we shall integrate for p from 0 to p_1 , the perpendicular upon the tangent parallel to C , and for ψ from 0 to 2π . Then

$$(i) \iint C dp d\psi = \frac{1}{2}A \cdot 2\pi = A\pi, \text{ as before};$$

$$(ii) \iint pC dp d\psi = \frac{1}{2}A \int \bar{p} d\psi, \text{ where } \bar{p} \text{ is the perpendicular from the centroid of the half area upon a line through } O \text{ parallel to the chord } (p, \psi) = \frac{1}{2}A \cdot \text{Perim. of } G\text{-path.}$$

$$\text{Thus } M(\triangle OAB) = \frac{\iint \frac{1}{2}pC dp d\psi}{\iint dp d\psi} = \frac{1}{4}A \cdot \frac{\text{Perim. of } G\text{-path}}{\text{Perim. of oval}}.$$

1729. Mean n^{th} Power of the Distance between two Random Points within an Oval.

This mean may be expressed as an integral in terms of a chord. Let X, Y be the random points, and ψ the inclination

of XY to a given direction. Let C be the length of the chord AB through X, Y ; ON ($=p$) the perpendicular from an origin O within the oval to AB ; $XA=r, XB=-r', XY=\rho$. Keep X fixed at first. Then the sum of all the values of ρ^n which are contained between AXB and a chord $A'XB'$, making an angle $d\psi$ with the former, each multiplied by an element of area, is

$$\int_0^r \rho^n (\rho d\psi d\rho) + \int_0^{r'} \rho^n (\rho d\psi d\rho) = \frac{r^{n+2} + r'^{n+2}}{n+2} d\psi;$$

and integrating this for all positions of X lying between the parallel chords (p, ψ) and $(p+dp, \psi)$, we have

$$\int \frac{r^{n+2} + r'^{n+2}}{n+2} d\psi dp dr,$$

$dp dr$ being the element of area in which X lies. And r varies from zero to C and $r'=C-r$. We therefore obtain

$$\frac{[r^{n+3}]_0^C - [r'^{n+3}]_0^C}{(n+2)(n+3)} d\psi dp = \frac{2C^{n+3}}{(n+2)(n+3)} d\psi dp.$$

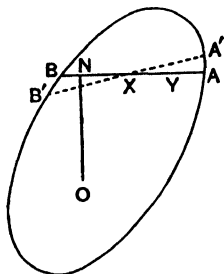

Fig. 579.

The final stage of the integration is to sum this expression for all elements $dp d\psi$ within the contour and then to divide by the number of cases, which is measured by A^2 .

$$\text{Hence } M(\rho^n) = \frac{2}{(n+2)(n+3)} \frac{1}{A^2} \iint C^{n+3} dp d\psi; \quad (n > -2).$$

1730. In the case, where $n = -1$, we have

$$M\left(\frac{1}{\rho}\right) = \frac{1}{A^2} \iint C^2 dp d\psi.$$

This may be interpreted as an expression for the mean value of the mutual potential of a pair of unit particles at random points within the contour.

$$\text{The case } n=0 \text{ gives } A^2 = \frac{1}{3} \iint C^3 dp d\psi.$$

$$\text{The case } n=1 \text{ gives } M(\rho) = \frac{1}{6A^2} \iint C^4 dp d\psi.$$

$$\text{The case } n=2 \text{ gives } M(\rho^2) = \frac{1}{10A^2} \iint C^5 dp d\psi.$$

But since $M(\rho^2) = 2k^2$, where k is the radius of gyration about the centroid,

$$A^2k^2 = \frac{1}{20} \iint C^5 dp d\psi.$$

We obtain thus the mean values of various powers of C for cases in which the mean values of the corresponding powers of ρ have been otherwise found.

Thus, for instance,

$$M(C^3) = \frac{\iint C^3 dp d\psi}{\iint dp d\psi} = \frac{3A^2}{L} = 3 \frac{(\text{Area})^2}{\text{Perimeter}},$$

$$M(C^5) = \frac{\iint C^5 dp d\psi}{\iint dp d\psi} = \frac{20 \cdot \text{Area} \cdot (\text{Moment of In. about centroid})}{\text{Perimeter}}.$$

1731. Other Results due to Crofton.

Let ρ be the distance between any two random points X, Y within a given convex contour of area A and perimeter L . Then the probability that any random line drawn across the contour also crosses a particular position XY of the line joining the random points is $2\rho/L$.

If n be the number of cases of a random line XY , the chance that any particular one is selected is $1/n$. Therefore the chance that a particular one is selected and cut by the random chord is $2\rho/nL$; and the chance that a random chord cuts a random line XY is the sum of the values of $2\rho/nL$ for all the cases of a pair of random points (Fig. 580),

$$= \frac{2}{L} \sum \frac{\rho}{n} = \frac{2}{L} M(\rho) = \frac{1}{3A^2L} \iint C^4 dp d\psi.$$

Again, suppose the random chord to divide A into two parts Σ and Σ' . The chance that X lies in Σ and Y in Σ' , or X in Σ' and Y in $\Sigma = 2\Sigma\Sigma'/A^2$ for any particular position of the chord. If m be the number of random chords, the chance of selection of any particular one is $1/m$, and the chance that a particular chord should be selected for which X and Y lie

on opposite sides is $\frac{1}{m} \frac{2\Sigma\Sigma'}{A^2}$; and the chance that a random chord should cut a random XY ,

$$= \frac{2}{A^2} M(\Sigma\Sigma') = \frac{2}{A^2} \frac{\iint \Sigma\Sigma' dp d\psi}{\iint dp d\psi} = \frac{2}{A^2 L} \iint \Sigma\Sigma' dp d\psi.$$

Hence, by equating the two values of the chance, we have

$$\iint C^4 dp d\psi = 6 \iint \Sigma\Sigma' dp d\psi.$$

Moreover we have two expressions for $M(\rho)$, viz.

$$\frac{1}{6A^2} \iint C^4 dp d\psi \quad \text{and} \quad \frac{1}{A^2} \iint \Sigma\Sigma' dp d\psi$$

(Crofton, *Proc. Lond. Math. Soc.*, viii.). This furnishes an interesting illustration of a difficult geometrical result arrived at by a consideration of mean values and chances.

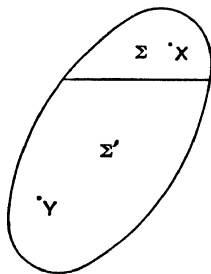

Fig. 580.

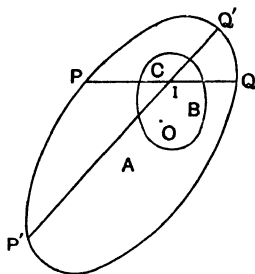

Fig. 581.

1732. *A and L being respectively the area and perimeter of a given convex contour which encloses a second contour of area B, it is required to find the chance that a pair of random chords PQ, P'Q' of the former should intersect within the latter.* (Fig. 581.)

Take an origin O within the smaller contour, and let the random chords be denoted by the $p-\psi$ system. Let a particular position of PQ intersect B , and suppose C the length of the chord intercepted upon it by B . The number of random lines cutting C is measured by $2C$. The number of random chords of A is measured by L . Therefore the chance that one of these cuts C is $2C/L$.

The chance that the particular chord C is one of the lines whose p and ψ lie between p and ψ , $p+dp$ and $\psi+d\psi$ is $dp d\psi / \iint dp d\psi = dp d\psi / L$, the integration being taken for the A -contour.

Therefore the chance that whilst the chord PQ lies between these limits it is met by a second random chord at a point within B is $2C dp d\psi / L^2$, and the total chance of the intersection of two random chords of A lying within B is $\frac{2}{L^2} \iint C dp d\psi$ for all values of p, ψ which can give chords intersecting B . Therefore

the required chance $= 2\pi B / L^2 = 2\pi \cdot \text{Area of } B / (\text{Perim. of } A)^2$.

1733. The above result is independent of the area of A or the perimeter of B , and except that it involves B and L it is independent of the shape and relative position of the ovals.

When the inner curve coincides with the outer, $B=A$, and the result becomes $2\pi \cdot \text{Area} / (\text{Perimeter})^2$.

1734. Next take a very small convex contour of area $d\sigma$ external to A . Let a random chord of A cut the perimeter of this small contour at P and Q , and let $PQ=\lambda$, which is a small quantity of, say, the first order. The chance that the p and ψ of this chord should lie between (p, ψ) and $(p+dp, \psi+d\psi)$ is $dp d\psi / \iint dp d\psi$, the integration being for the contour A , *i.e.* $dp d\psi / L$.

Let θ_1 and θ_2 be the angles which the tangents from P to the oval make with any specific position of PQ (Fig. 582). Then regarding the chord PQ as itself a narrow oval whose greatest breadth is an infinitesimal of the second order, the chance that a random chord of A cuts this line PQ is, by Art. 1719, (Crossed Belt—Uncrossed Belt)/ L , *i.e.* in the limit $(2\lambda - \lambda \cos \theta_1 - \lambda \cos \theta_2) / L$. Hence the chance that the chord of A should be selected to lie between (p, ψ) and $(p+dp, \psi+d\psi)$, and then cut by a second random chord of A within the small contour, is

$$\frac{dp d\psi}{L} \cdot \frac{\lambda}{L} (\text{vers } \theta_1 + \text{vers } \theta_2).$$

Now λ being an infinitesimal of the first order, θ_1 and θ_2 may be regarded as constant throughout $d\sigma$ for a given direction of PQ , and the integration $\int \lambda dp$ gives the area $d\sigma$ when taken for the small area. This integration therefore gives $d\sigma d\psi(\text{vers } \theta_1 + \text{vers } \theta_2)/L^2$. We next integrate with regard to ψ , and $\text{vers } \theta_1 + \text{vers } \theta_2 = 2 - \cos(\omega - \theta_2) - \cos \theta_2$, where ω is the angle subtended by A at the elementary area $d\sigma$.

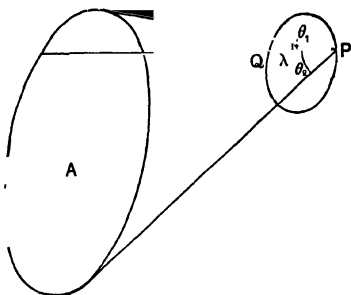

Fig. 582.

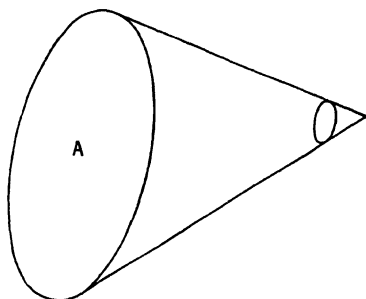

Fig. 583.

The possible directions of the chord cutting PQ will vary between the directions of the common non-crossing tangents to A and $d\sigma$, and one of these tangents may be taken as the fixed direction from which ψ is measured. We therefore have $d\psi = d\theta_2$, and we have to integrate from $\psi = 0$ to $\psi = \omega$. This gives

$$\frac{d\sigma}{L^2} \int_0^\omega [2 - \cos(\omega - \psi) - \cos \psi] d\psi = \frac{2d\sigma}{L^2} (\omega - \sin \omega).$$

We may now integrate this through any finite convex oval of area B external to A . Thus the chance that two random chords of A intersect within B is $\frac{2}{L^2} \int (\omega - \sin \omega) d\sigma$.

1735. If B be taken as the whole of space external to A , the chance of the random chords intersecting outside A must be $1 -$ the chance of intersecting within A , i.e. $1 - \frac{2\pi A}{L^2}$.

Hence we obtain the remarkable theorem that

$$2 \int (\omega - \sin \omega) d\sigma = L^2 - 2\pi A,$$

where the integration is taken over the whole plane external to A . This theorem is also due to Crofton. It is quoted by Bertrand, *Calc. Int.*, p. 491. It is another curious example (see Art. 1731) of a geometrical fact brought to light by consideration of chances.

1736. **D'Alembert's Mortality Curve.** (See Todhunter, *History*, p. 268.)

Definitions. Mean Duration of Life. For a person of age x years, the mean duration of life beyond x years is the sum of the lengths of the lives lived by a large number of persons beyond that age, divided by the number of persons.

Probable Duration of Life. For a person of age x years, the probable duration of life beyond x years is such a period that it is an even chance whether the life of the individual exceeds or falls short of it.

1737. Let $\psi(x)$ denote the number of persons still living x years after their births. Then the graph of $y = \psi(x)$ is known as the curve of mortality.

Let c years be the supreme limit of life, *i.e.* the greatest age to which any person can attain. Then $\psi(c) = 0$.

By the definition,

Mean duration for a person aged a years $= \int_a^c \psi(x) dx / \psi(a)$,

Probable duration for a person aged a years $= b$ years,

where $\psi(b) = \frac{1}{2} \psi(a)$.

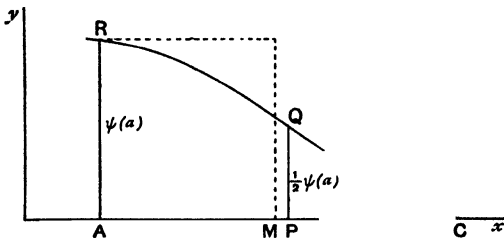

Fig. 584.

In Fig. 584, $OC = c$ is the limit of longevity, $OA = a$ years.

The ordinate AR represents the number of persons alive at age a years, AP the probable duration of life beyond the

age a for persons now of age a , the ordinate at P being half that at A . AM measures the mean duration for persons of age a years, and is such that $AR \cdot AM = \text{area } RAPCQR$.

1738. **A Different View.**

The usual method of estimating the mean and probable duration of life for a person aged a years is somewhat different from that explained above, but will be shown to be in agreement with it.

Let $\phi(x)dx$ be the number of persons who die between the ages of x and $x+dx$. Then, since $\psi(x) \equiv$ the number of persons living at age x , $\psi(x+dx)$ is the number living at age $x+dx$. Hence to the first order, $\phi(x)dx = \psi(x) - \psi(x+dx) = -\psi'(x)dx$ and $\phi(x) = -\psi'(x)$. Suppose a person to die at the age of x years, where $x > a$. The length of life for this person beyond a years $= x - a$, and the average value of this is

$$\int_a^c (x-a) \phi(x) dx / \int_a^c \phi(x) dx.$$

This then is the *mean* duration for persons of age a years. The *probable* duration is b years where

$$\int_a^b \phi(x) dx = \int_b^c \phi(x) dx, \text{ i.e. } \int_a^b \phi(x) dx = \frac{1}{2} \int_a^c \phi(x) dx.$$

1739. **Agreement.**

The agreement of these estimates with those of D'Alembert will be clear.

For (i) $\int_a^c \phi(x) dx = - \int_a^c \psi'(x) dx = \psi(a) - \psi(c) = \psi(a)$

and $\int_a^c (x-a) \phi(x) dx = - \int_a^c (x-a) \psi'(x) dx$
 $= - \left[(x-a) \psi(x) \right]_a^c + \int_a^c \psi(x) dx = \int_a^c \psi(x) dx ;$

$\therefore \int_a^c (x-a) \phi(x) dx / \int_a^c \phi(x) dx = \int_a^c \psi(x) dx / \psi(a).$

(ii) Again, since $\int_a^b \phi(x) dx = \frac{1}{2} \int_a^c \phi(x) dx$, we have

$$\int_a^b \psi'(x) dx = \frac{1}{2} \int_a^c \psi'(x) dx ;$$

$\therefore \psi(b) - \psi(a) = \frac{1}{2} \{ \psi(c) - \psi(a) \} = -\frac{1}{2} \psi(a) ; \quad \psi(b) = \frac{1}{2} \psi(a).$

1740. **Chance of Survival.**

For a person of present age a , the chance of death between the ages p and q ($p < q$) is $\frac{\psi(p) - \psi(q)}{\psi(a)}$, and $\frac{\psi(a) - \psi(c)}{\psi(a)} = 1$, and the chance of survival to at least the age of q is $\psi(q)/\psi(a)$.

The probability of death between the ages of x and $x + dx$ for a person of age a is

$$\frac{\psi(x) - \psi(x + dx)}{\psi(a)} = -\frac{\psi'(x)}{\psi(a)} dx.$$

The probability of death for a person of age x years, between the ages of x and $x + dx$, *i.e.* of almost immediate death, is $-\psi'(x) dx/\psi(x) = -d \log \psi(x)$.

1741. **Expectation of Life.**

Defining the "Expectation of Life" at a definite age of a years as the average or mean duration of life after that age, the following results were calculated by Neison (*Vital Statistics*, p. 8) from the tables of the Registrar General. (See Boole, *Finite Differences*, p. 45.)

Age	10	20	30	40	50	60	70	80	90
Expectation	47.7564	40.6910	34.0990	27.4760	20.8463	14.5854	9.2176	5.2160	2.8930

Δ (Expectation) -7.0654 -6.5920 -6.0230 -6.6297 -6.2609 -5.3678 -4.0016 -2.3230,

Δ^2 (Expectation) .4734 - .0310 - .0067 .3688 .8931 1.3662 1.6786,

etc.

The expectations for intervening ages may be very closely obtained by the ordinary interpolation methods, *e.g.*

$$u_{x+n} = u_x + n\Delta u_x + \frac{n(n-1)}{1.2} \Delta^2 u_x + \frac{n(n-1)(n-2)}{1.2.3} \Delta^3 u_x + \dots$$

But probably no purely algebraical law expressed as a series in powers of the age, on which supposition interpolation formulae are based, would be adequate to express the true law of expectation for all ages; particularly near the extremities of the table, for ages of very young children or for persons of very advanced years. The graph of this expectation is shown in Fig. 585.

In the decades of the first differences from 20 to 60, it will be noted that there is but small change. Hence in the graph of the expectation the fall in the value of the expectation between these ages is roughly uniform, and this portion of

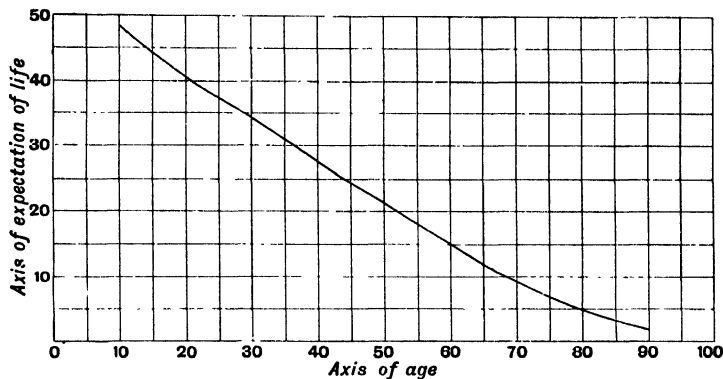

Fig. 585.

the graph is very approximately straight. From the age of 60 onwards the curvature shows a definite bending away from the axis of age, the curve becoming more definitely convex at each point to the foot of the ordinate. This is the curve

$$y = \int_x^c \psi(\xi) d\xi / \psi(x), \text{ that is } y = \int_x^c (\xi - x) \phi(\xi) d\xi / \int_x^c \phi(\xi) d\xi.$$

1742. Remarks on the Mortality Curve.

It has been remarked by Todhunter (*Hist. of Prob.*, p. 269) that the "mean duration" beyond a represents the abscissa of the "centre of gravity of a certain area," namely of that area which is bounded by the curve $y = \phi(x)$, the x -axis and its ordinate for age a , the abscissa in question being measured from $x = a$. The "probable duration" beyond a is represented by the abscissa, also measured from $x = a$, of the ordinate which bisects that area. It would appear from tables that the "mortality curve" $y = \psi(x)$ is not either always concave or always convex to the foot of the ordinate upon the x -axis, and also that the probable duration is not always greater than the mean duration. (See Todhunter's remarks on Buffon's tables and on d'Alembert's views, *History of Prob.*, p. 285.)

1743. Let us take a supposititious law that the probability of a person of present age x years dying before he is aged $x + dx$ is $\lambda x^n dx$, where λ and n are certain constants.

Let $\psi(x)$ denote the number of persons alive x years after their birth, $\phi(x) dx$ the number who die between x and $x + dx$. Then $\phi(x) = -\psi'(x)$.

And $\frac{\phi(x) dx}{\psi(x)}$ is the probability that a person aged x will die between x and $x + dx$. Hence $\psi'(x)/\psi(x) = -\lambda x^n$, i.e. $\psi(x) = A e^{-\lambda \frac{x^{n+1}}{n+1}}$, where A is a constant and $\psi(0) = A$.

Hence the mean duration of life from birth is $\int_0^e e^{-\lambda \frac{x^{n+1}}{n+1}} dx$.

When x is large, the integrand becomes extremely small, and its value is insensible. Hence we may, without sensible error, take e , the superior limit of age, to be ∞ . Put

$$\frac{\lambda x^{n+1}}{n+1} = z; \quad \therefore dx = \frac{1}{n+1} \left(\frac{n+1}{\lambda} \right)^{\frac{1}{n+1}} z^{\frac{1}{n+1}-1} dz = \frac{1}{\lambda} \left(\frac{n+1}{\lambda} \right)^{\frac{1}{n+1}-1} z^{\frac{1}{n+1}-1} dz.$$

\therefore Mean duration at birth

$$= \frac{1}{\lambda} \left(\frac{\lambda}{n+1} \right)^{\frac{n}{n+1}} \int_0^{\infty} z^{\frac{1}{n+1}-1} e^{-z} dz = \frac{1}{\lambda} \left(\frac{\lambda}{n+1} \right)^{\frac{n}{n+1}} \Gamma\left(\frac{1}{n+1}\right).$$

The Probable duration of life at birth is b years, where $e^{-\frac{\lambda b^{n+1}}{n+1}} = \frac{1}{2}$,

$$\text{i.e. } b^{n+1} = \frac{n+1}{\lambda} \log_e 2, \quad \text{i.e. } b = \left\{ \frac{n+1}{\lambda} \log_e 2 \right\}^{\frac{1}{n+1}}.$$

For a person of age a years, the probability of death within the next r years

$$= \frac{e^{-\frac{\lambda a^{n+1}}{n+1}} - e^{-\frac{\lambda(a+r)^{n+1}}{n+1}}}{e^{-\frac{\lambda a^{n+1}}{n+1}}} = 1 - e^{-\frac{\lambda a^{n+1}}{n+1} \left[(1+\frac{r}{a})^{n+1} - 1 \right]}.$$

If r be small in comparison with a , this becomes approximately

$$K \frac{r}{a} \left\{ 1 - \frac{K-n}{2} \frac{r}{a} \right\}, \quad \text{where } K = \lambda a^{n+1}.$$

PROBLEMS.

1. A cardioid is drawn upon a plane and a point P is taken at random within the contour; show that the chance that it is nearer to the vertex than to the cusp is

$$\frac{1}{\pi} \left(\alpha + \frac{\sqrt{5}}{3} \cos^{\frac{3}{2}} \alpha \right), \quad \text{where } \cos \alpha = 2 \sin \frac{\pi}{10}.$$

2. Given that p and q are any two positive quantities, of which q cannot exceed 9 and p cannot exceed 6, show that it is a 2 : 1 chance that the roots of the quadratic $x^2 - px + q = 0$ are imaginary.

3. Three positive quantities are chosen at random, except that their sum is known. Show that the chance that the sum of any two is greater than $1/n^{\text{th}}$ of the third is $1 - 3/(n+1)^2$, provided $n \leq 1$.

4. There are n letters and n directed envelopes. The letters are placed at random, one in each envelope. Show that the chance that r specified letters go wrong and s specified letters go right is

$$[(n-s)! - r(n-s-1)! + \frac{r(r-1)}{1 \cdot 2} (n-s-2)! - \dots + (-1)^r (n-s-r)!] / n!,$$

where $n \leq r + s$.

5. A circle of radius r lies entirely within an ellipse of semi-axes a and b ; $m+n$ random points are taken within the ellipse. What is the chance that m of them lie within the circle and the rest do not?

6. Let two points P and Q be taken at hazard in a line AB in either order, and let three other points be now taken at hazard upon the line. What is the chance that (i) all three should lie between P and Q , (ii) one should lie between P and Q and the others not so, (iii) two specified ones should fall between P and Q and the other not so?

7. A point P is chosen at random upon a line AB , and then a random point Q is taken upon AP . Show that the chance that AQ is less than $1/n^{\text{th}}$ of AB is $\log \sqrt[n]{en}$, ($n > 1$).

8. Four random points are taken upon a straight line. Show that the chance that the sum of the squares of the five parts should not exceed the square on half the line is $3\pi^2/100\sqrt{5}$.

9. A rod is divided into five pieces at random. Show that the chance that none of them is less than $1/10$ of the whole is $1/16$.

10. A rod AB is broken into three pieces AP , PQ , QB at random. Show that the chance that the sum of the squares of AP and QB shall be less than the square of $5PQ$ is $\frac{25}{100\sqrt{2}} (35 - 6 \log 3/\sqrt{2})$.

11. A random point X is taken upon a line AB . Six other random points are then taken on AB . What is the chance that two of these will lie on AX and four on XB ?

12. From an urn containing an infinite number of balls, all of which are known to be either red or white, a group of seven is drawn out at random, and four are found to be red and three white. What is the chance that a second draw of seven shall also produce four red and three white?

13. A square ticket of side a is thrown at hazard upon a large table ruled into squares of side $2a$. Show that the chance that the ticket will cross a ruling is about 0.86.

14. A circle of radius a is thrown at hazard upon a table ruled in squares of side $3a$. Show that the chance of crossing a ruling is $5/9$.

15. A large table is ruled with parallel lines two inches apart. A one-inch equilateral triangle is thrown at hazard upon the table. Show that the chance it cuts a ruling is $3/2\pi$.

16. A letter L , with thin arms 3 inches long and at right angles to each other, is thrown at hazard upon a large table ruled with parallels 4 inches apart. Show that the chance of crossing a ruling is $3(2 + \sqrt{2})/4\pi$.

17. A cardioid of axis $2a$ inches is thrown at hazard upon a large table ruled with parallel lines at a distance $4a$ inches apart. Show that the chance it cuts a ruling is $9\sqrt{3}/8\pi$.

18. Show that the mean value of the cubes of all random chords of a circle $= \frac{3}{2} \times \text{area of circle} \times \text{radius}$.

19. Show that the mean value of the cubes of all random chords which meet an equilateral triangle of side a is $3a^3/16$.

20. Show that the mean value of the lengths of all random lines terminated by the sides of a square of side a is $\pi a/4$.

21. A circle of radius b lies entirely within a circle of radius a . Show that the chance that a pair of chords of the latter intersect within the former is $b^2/2a^2$.

22. Show that the chance that a pair of random chords of the director circle of an ellipse of semi-axes a and b should not intersect within the ellipse is $1 - ab/2(a^2 + b^2)$.

23. Evaluate the integral $\int (\omega - \sin \omega) d\sigma$ for all elements of area $d\sigma$ which lie outside a given circle of radius a , ω being the angle

between the tangents from the element $d\sigma$ to the circle. Explain the connection of this integral with the theory of chances.

24. Find the chance that if two points be taken at random within a circle of radius a the distance between them will be $< c$ where $c < 2a$.

[ST. JOHN'S, 1885.]

25. Two men, A and B , are walking at rates equally likely to be anything from 0 to a miles an hour and from 0 to b miles an hour respectively. They walk in the same direction along a straight road for a time $c/(a - b)$ hours, where c miles is the initial distance between them. What is the probability that A , who starts behind B , will overtake him?

[TRINITY, 1889.]

26. Suppose there are n sugar sticks each of length $2a$, each broken at random into two pieces. A child is promised the biggest of the $2n$ pieces. What is the value of his expectation?

[W. A. WHITWORTH, *E. T.*, 13736.]

Show that the expectation of the piece of r^{th} largest size is $\{(r + 1)n + 1\}/2r(n + 1)$ of a whole stick.

27. If there be an infinite number of balls in an urn, each ball being known to be of one of n different colours, and if $p_1 + p_2 + \dots + p_n$ balls have been drawn and found to be p_1 of one colour, p_2 of another colour, etc., what is the chance that a further drawing of $q_1 + q_2 + q_3 + \dots + q_n$ will yield q_1 of the first colour, q_2 of the second, etc.?

[ZERR, *E. T.*, 11924.]

28. Two points are taken at random within a circle of radius r , and a chord is drawn at random. Find the chance that the chord passes between the points.

[COLLEGES β , 1888.]

29. An equilateral triangle lies entirely within a regular hexagon whose sides are equal to those of the triangle. A random chord is drawn to cut the hexagon. Show that it is an even chance that it also cuts the triangle.

30. In a circle of radius a the mean of the inverse distance between two random points within the circle is $16/3\pi a$.

[CROFTON, *Lond. M.S. Proc.*, viii., p. 309.]

31. If the probability of a person of age x years dying before he is aged $x + dx$ be $\lambda x dx$, show that the average length of life from birth is $\sqrt{\pi/2\lambda}$. (See a problem by Stanham, *E. T.*, 13021.) Also show that the probable duration of life is $\sqrt{(2 \log 2)/\lambda}$, which is rather less than the average duration.

32. Prove that
$$\int_{\frac{\pi}{8}}^{\frac{\pi}{4}} (\theta - \sin \theta \cos \theta) \sin \theta \cos \theta d\theta = \frac{\pi}{16} - \frac{3\sqrt{3}}{64}.$$

Two points are taken at random within a circle. Find the chance that their distance apart is less than the radius of the circle.

[Ox. I. P., 1916.]

33. Show that the mean of the cubes of all lines PQ , which are random chords drawn across the contour, are (i) for a square of side a , $3a^3/4$; (ii) for a circle of radius a , $3\pi a^3/2$; (iii) for a semicircle of radius a , $3\pi^2 a^3/4(\pi + 2)$.

34. Show that the mean of the fifth powers of all lines PQ , which are random chords drawn across the contour, are (i) for a square of side a , $5a^5/6$; (ii) for an equilateral triangle of side a and area Δ , $5a\Delta^2/9$; (iii) for a circle of radius a , $5\pi a^5$.

35. If two pennies of diameter d be soldered together by their edges so as to be in firm contact in a plane, and be thrown upon a plane ruled with equidistant parallel lines whose distance apart is a ($a > 2d$), show that the chance of both pennies being cut by a ruling is $(\pi - 2)d/\pi a$.

36. If a straight line be divided at random into four parts, prove that the chance that one of the parts shall be greater than half the line is $1/2$. Show also that the chance that three times the sum of the squares on the parts is less than the square on the whole line is $\pi\sqrt{3}/18$.

37. If a straight line be divided at random into five parts, show that the chance that four times the sum of the squares of the parts is less than the square on the whole line is $3\pi^2\sqrt{5}/500$.

[WOLSTENHOLME, *E. T.*, 2753.]

38. If random values between $\pm a^2$ be assigned to H and between $\pm(2\alpha^3 + \beta^2)$ to G in the cubic $x^3 + 3Hx + G = 0$, show that the chance of three real roots $= \frac{2}{5} \frac{a^3}{2\alpha^3 + \beta^2}$.

39. Obtain the mean value of $x^2 + y^2 + z^2$ subject to the condition $x + y + z = 0$, and that x, y, z each lie between $-c$ and $+c$.

[LAPLACE; TODHUNTER, *Hist.*, p. 411.]

CHAPTER XXXVIII.

ERRORS OR UNCERTAINTIES OF OBSERVATIONS.

1744. Suppose a large number of observations to be made to ascertain the measurement of some physical element. To fix the ideas take one of the simplest kind, the distance between two marked points A and B on a straight rod. Suppose the distance AB to be roughly known to be 10 feet long, but that its true value T is unknown to the observers, of whom there are many, but known to some other person. And suppose that as great accuracy as possible is required. Out of a large number of observations by careful observers, it is clear that there will be none of them which differ very much from the true value T . The more care is taken, and the more accurate the means of measurement at disposal, the closer will the estimates be together. And it is a matter of experience that slight over estimates are as likely as under estimates, and occur with equal frequency. Absolute "mistakes" of counting feet or inches, or of registration of units, or of the use of the instruments we are not considering. In fact we eliminate from this explanation any errors which are of the class of careless "blunders."

It will be found by the person who knows the true value T , that very few of the estimates differ from T by as much as $\frac{1}{2}$ an inch either way; fewer still by $\frac{3}{4}$ of an inch, still fewer by a whole inch, whilst errors of 4 or 5 inches would not occur in the tabulated results of the observations at all. And if the *number* of observations which give an error between x and $x+dx$ be represented graphically, it will be found that the graph takes the form of a curve symmetrical

about the y -axis, having a maximum ordinate at the origin, falling rapidly to the x -axis, the ordinate speedily becoming insensibly small (see Fig. 586).

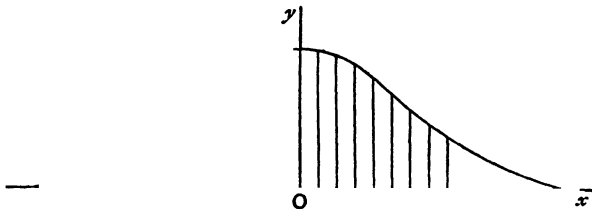

Fig. 586.

1745. It follows, therefore, that for the existence of an error of magnitude lying between x and $x+dx$, there will be a far greater probability when x is small than when x is large; *i.e.* a far greater number of errors of observation will fall between x and $x+dx$ for small values of x than for larger ones. Let $\phi(x)dx$ be that number. We wish to examine the nature of this function $\phi(x)$. And about it we know that

- (i) it decreases very rapidly as x increases;
- (ii) it must be such as to become insensibly small within a short range of values of x ;
- (iii) it must be an even function of x , as errors of excess or defect are equally numerous within corresponding limits;
- (iv) it must contain some constant or constants depending upon the goodness of the observation, the training and competence of the observer, the accuracy of the instruments used, and the circumstances under which the observation is made;
- (v) the number of observations must be $\int_{-\infty}^{\infty} \phi(x)dx$, and supposing N be this number, the chance that the error of any particular observation lies between x and $x+dx = \phi(x)dx/N = \psi(x)dx$, say.

1746. Laplace's Investigation.

Starting with the hypothesis that an error in an observation is due to no one single cause, but is the aggregate of the

cumulative effects of a large number of causes, each producing its own separate effect, and that these effects are extremely small, and as likely to be positive as negative, Laplace has shown by a very laborious and difficult investigation that the chance that the error lies in magnitude between x and $x+dx$, viz. $\psi(x)dx$, is $\sqrt{\frac{\omega}{\pi}} e^{-\omega x^2} dx$ for some value of ω which depends upon the goodness of the observation. The argument is of such length that we must refer the reader to Laplace's original work (*Théorie Analytique des Probabilités*). We therefore assume the law as our fundamental hypothesis in what follows. A good idea of the principal steps in the process, which avoids the obscurity of the original work of Laplace, will be found in Airy's *Theory of Errors of Observation*, pages 7 to 15. Todhunter's *History of Probability*, Arts. 1001 onwards, may be consulted, also a paper by Leslie Ellis (*Trans. Camb. Phil. Soc.*, viii.), and a paper by Merriman (*Trans. Conn. Acad.*, iv.).

1747. The Frequency Law.

The law $\psi(x) = \sqrt{\frac{\omega}{\pi}} e^{-\omega x^2}$ is termed the law of "Facility" or "Frequency" of Errors. It will be noticed at once that this is a probable law, for it answers all the requirements laid down in Art. 1745. It has a maximum at $x=0$, it is an even function of x , it contains an arbitrary constant ω , it diminishes with great rapidity as x increases, and speedily becomes of insensible magnitude, and

$$\int_{-\infty}^{\infty} \phi(x) dx = N \int_{-\infty}^{\infty} \sqrt{\frac{\omega}{\pi}} e^{-\omega x^2} dx = N.$$

1748. Weight and Modulus.

The constant ω is called the *weight* of the observation. It is sometimes replaced by $\frac{1}{c^2}$. Then c or $\frac{1}{\sqrt{\omega}}$ is called the *modulus*. The weight ω measures the care, skill and precision of the observer, the goodness of his instruments and the excellence of the conditions under which the observation is made.

1749. The ordinary method of estimating the value of a physical element of which a number of presumably equally good measurements have been made is to take the arithmetical mean of the result. As a matter of experience this gives good results, and therefore this mean is frequently adopted as giving the best estimate available, and regarded as the most likely value. If we might assume this, the above law of Facility of Errors easily follows.

Let T be the true value of the measured quantity, T being unknown. Let z_1, z_2, \dots, z_n be n independent results of observation; $\phi(x)$ the law of Facility.

Then $z_1 - T, z_2 - T, \dots, z_n - T$ are the actual errors, some positive, some negative, and the *a priori* probability of the coexistence of these errors is proportional to the product

$$P \equiv \phi(z_1 - T) \phi(z_2 - T) \dots \phi(z_n - T).$$

Then, by the principles of inverse probability, the probability that the true value lies between T and $T + dT$ is $P dT / \int P dT$,

the limits being such that the integration is conducted over all values of T which it is capable of assuming. That is, after the observations were made, the probability that T is the true value is also proportional to the product P , and therefore this expression is to be made a maximum by variation of T . Taking logarithms and differentiating, we have $\sum_1^n \phi'(z_r - T) / \phi(z_r - T) = 0$.

Now, if we take for T the arithmetic mean of the observations, this equation is to hold when $nT = \sum_1^n z_r$. To find the form of ϕ which will satisfy these requirements, take the case $z_2 = z_3 = \dots = z_n = z_1 - n\tau$. Then

$$nT = z_1 + (n-1)z_2 = z_1 + (n-1)(z_1 - n\tau) = nz_1 - n(n-1)\tau,$$

$$\text{i.e. } z_1 - T = (n-1)\tau, \quad z_2 - T = (z_2 - z_1) + (z_1 - T) = -\tau,$$

$$z_3 - T = -\tau, \text{ etc. ;}$$

$$\therefore \frac{\phi'(z_1 - T)}{\phi(z_1 - T)} + (n-1) \frac{\phi'(z_2 - T)}{\phi(z_2 - T)} = 0$$

$$\text{or } \frac{\phi'(n-1)\tau}{(n-1)\tau\phi(n-1)\tau} = \frac{\phi'(-\tau)}{(-\tau)\phi(-\tau)},$$

which is independent of n ; and this is to be true for all positive integral values of n .

This will be satisfied if ϕ be such that $\frac{1}{u} \frac{\phi'(u)}{\phi(u)} = \text{const.} = C$;

whence $\log \phi(u) = C \frac{u^2}{2}$ and $\phi(u) = A e^{C \frac{u^2}{2}}$.

And since $\phi(u)$ is to decrease as u increases, C must be negative. Let $C = -\frac{2}{c^2}$. Then $\phi(u) = A e^{-\frac{u^2}{c^2}}$. Again, if N be the total number of observations,

$$N = \int_{-\infty}^{\infty} \phi(u) du = \int_{-\infty}^{\infty} A e^{-\frac{u^2}{c^2}} du = A c \sqrt{\pi}; \quad \therefore A = N/c\sqrt{\pi},$$

i.e.
$$\phi(x) = \frac{N}{c\sqrt{\pi}} e^{-\frac{x^2}{c^2}},$$

which establishes the law of facility under the hypothesis specified as to the Arithmetic mean.

This remark is made by Dr. Glaisher in the solutions of the *Senate H. Problems* for 1878, pages 167, 168, where there will also be found a concise account of the allied subject of the principle of "Least Squares." [See also Todhunter, *Hist.*, Art. 1014.]

1750. Mean of the Errors, Mean of the Squares, Error of Mean Square, Probable Errors.

The following facts will now appear :

(1) The mean of all the positive errors

$$\begin{aligned} & \int_0^{\infty} x \frac{1}{c\sqrt{\pi}} e^{-\frac{x^2}{c^2}} dx \\ &= \frac{\int_0^{\infty} \frac{1}{c\sqrt{\pi}} e^{-\frac{x^2}{c^2}} dx}{\int_0^{\infty} \frac{1}{c\sqrt{\pi}} e^{-\frac{x^2}{c^2}} dx} = \frac{c}{\sqrt{\pi}} = \frac{1}{\sqrt{\pi\omega}}. \end{aligned}$$

(2) The mean of all the negative errors with their signs changed is also $\frac{c}{\sqrt{\pi}} = \frac{1}{\sqrt{\pi\omega}}$.

(3) The mean of all the errors taken positively is $\frac{c}{\sqrt{\pi}} = \frac{1}{\sqrt{\pi\omega}}$.

(4) The mean of the squares of all the errors

$$= \frac{\int_{-\infty}^{\infty} x^2 \frac{1}{c\sqrt{\pi}} e^{-\frac{x^2}{c^2}} dx}{\int_{-\infty}^{\infty} \frac{1}{c\sqrt{\pi}} e^{-\frac{x^2}{c^2}} dx} = \frac{c^2}{2} = \frac{1}{2\omega}.$$

(5) The "Error of Mean Square," i.e. the square root of the mean of the squares of the errors, $= \frac{c}{\sqrt{2}} = \frac{1}{\sqrt{2\omega}}$. This is the abscissa of the point of inflexion on the Probability Curve $y = e^{-\frac{x^2}{c^2}}$.

(6) The "Probable Error," which is such that the number of positive errors which are greater than itself is equal to the number which are less, is given by the value of p , where

$$\int_0^p \frac{1}{c\sqrt{\pi}} e^{-\frac{x^2}{c^2}} dx = \frac{1}{2} \int_0^{\infty} \frac{1}{c\sqrt{\pi}} e^{-\frac{x^2}{c^2}} dx = \frac{1}{4}.$$

Let $x = cz$. Then $\frac{1}{\sqrt{\pi}} \int_0^{\frac{p}{c}} e^{-z^2} dz = 0.25$.

Tables have been calculated for the values of this integral for various values of the upper limit [Kramp's *Refractions; Encyc. Metropol.*, "Theory of Probabilities"], and interpolation from them gives $\frac{p}{c} = .476948\dots$. Hence the "Probable Error" $= .476948\dots c$ or $.476948\dots/\sqrt{\omega}$.

1751. **Kramp's Table** is given by Airy (*Th. of Errors*, p. 22), also by De Morgan (*Diff. Calc.*, p. 657). We reproduce Airy's abstract of this table for convenience for other purposes.

Integral tabulated, $I \equiv \frac{1}{\sqrt{\pi}} \int_0^x e^{-z^2} dz$.

x	I	x	I	x	I	x	I
0.0	0.000000	1.0	0.421350	2.0	0.497661	3.0	0.499988
0.1	0.056232	1.1	0.440103	2.1	0.498510		
0.2	0.111351	1.2	0.455157	2.2	0.499068		
0.3	0.164313	1.3	0.467004	2.3	0.499428		
0.4	0.214196	1.4	0.476143	2.4	0.499655		
0.5	0.260250	1.5	0.483053	2.5	0.499796		
0.6	0.301928	1.6	0.488174	2.6	0.499881		
0.7	0.338901	1.7	0.491895	2.7	0.499932		
0.8	0.371051	1.8	0.494545	2.8	0.499962		
0.9	0.398454	1.9	0.496395	2.9	0.499979	∞	0.500000

1752. Relative Magnitude of Probable Error, Mean Error, Error of Mean Square, Modulus.

To sum up, we have

$$\text{Probable Error} = .476948.../\sqrt{\omega};$$

$$\text{Mean Error} = 1/\sqrt{\pi\omega} = .564189.../\sqrt{\omega};$$

$$\text{Error of Mean Square} = 1/\sqrt{2\omega} = .707107.../\sqrt{\omega};$$

$$\text{Modulus} = 1/\sqrt{\omega};$$

in each case varying inversely as the square root of the weight, *i.e.* directly as the modulus; and obviously, when any one of these is found the rest may be deduced. They are arranged in ascending order of magnitude.

Taking the *x*-axis as the axis of magnitude of errors and the *y*-axis as the axis of frequency, Fig. 587 will exhibit to the eye the relative magnitude of these errors and the fall in frequency. The figure is that given by Airy (*loc. cit. sup.*). The abscissa is the ratio of the magnitude of an error to the modulus. The points *P*, *M* in the figure indicate respectively the abscissae for Probable and Mean Error.

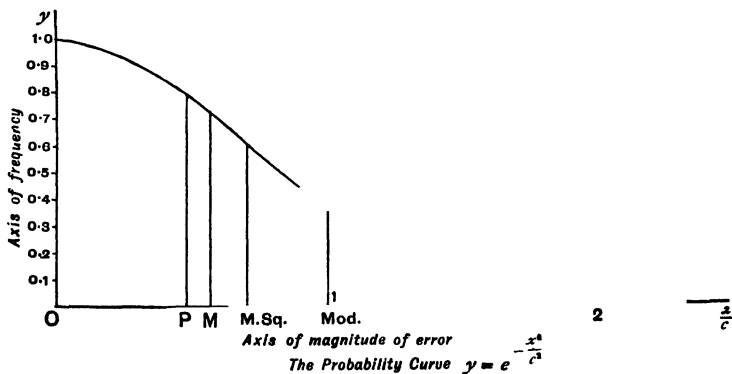

Fig. 587.

1753. Several Observations. Resultant Weight.

Suppose there to be a result *b* dependent upon two observations *a*₁ and *a*₂ of weights ω_1 , ω_2 respectively, say $b = \phi(a_1, a_2)$. To find the weight of the result.

Let *x*₁, *x*₂ be the actual errors and *z* the consequent error in *b*; all being small quantities of the first order, then to that order $z = \frac{\partial \phi}{\partial a_1} x_1 + \frac{\partial \phi}{\partial a_2} x_2 = \phi_{a_1} x_1 + \phi_{a_2} x_2$, say.

The chance of the co-existence of errors in a_1 and a_2 respectively between x_1 and x_1+dx_1 for the one and x_2 and x_2+dx_2 for the other is

$$\sqrt{\frac{\omega_1}{\pi}} e^{-\omega_1 x_1^2} dx_1 \cdot \sqrt{\frac{\omega_2}{\pi}} e^{-\omega_2 x_2^2} dx_2.$$

Therefore writing $\frac{1}{\omega} \equiv \frac{1}{\omega_1} \phi_{a_1}^2 + \frac{1}{\omega_2} \phi_{a_2}^2$, and $A = \frac{\omega}{\omega_1} \phi_{a_1}$, the chance of an error in b lying between z and $z+dz$ is

$$\frac{\sqrt{\omega_1 \omega_2}}{\pi} \int_{-\infty}^{\infty} dx_1 \left[\frac{dz}{\phi_{a_1}} e^{-\omega_1 x_1^2 - \omega_2 \left(\frac{\phi_{a_1}}{\phi_{a_2}}\right)^2 \left(\frac{z}{\phi_{a_1}} - x_1\right)^2} \right],$$

that is,
$$= \frac{\sqrt{\omega_1 \omega_2}}{\pi} e^{-\omega z^2} \frac{dz}{\phi_{a_1}} \int_{-\infty}^{\infty} e^{-\frac{\omega_1 \omega_2}{\omega \phi_{a_2}^2} (x-Az)^2} dx$$

$$= \frac{\sqrt{\omega_1 \omega_2}}{\pi} e^{-\omega z^2} \frac{dz}{\phi_{a_1}} \cdot \sqrt{\frac{\pi \omega \phi_{a_2}^2}{\omega_1 \omega_2}} = \sqrt{\frac{\omega}{\pi}} e^{-\omega z^2} dz.$$

The law of facility for the compound result $\phi(a_1, a_2)$ is therefore of precisely the same form as that for each of the original observations, but the weight of the combined result is ω , given by $\frac{1}{\omega} = \frac{1}{\omega_1} \left(\frac{\partial \phi}{\partial a_1}\right)^2 + \frac{1}{\omega_2} \left(\frac{\partial \phi}{\partial a_2}\right)^2$. And exactly in the same way if b depends upon several observations a_1, a_2, \dots, a_n of weights $\omega_1, \omega_2, \dots, \omega_n$ respectively, we have a resultant weight ω for the cumulative measure given by $\frac{1}{\omega} = \sum_1^n \frac{1}{\omega_r} \left(\frac{\partial \phi}{\partial a_r}\right)^2$.

It follows that, writing P.E. for Probable Error,

$$[\text{P.E. in } \phi(a_1, a_2, \dots)]^2 = (\text{P.E. in } a_1)^2 \left(\frac{\partial \phi}{\partial a_1}\right)^2 + (\text{P.E. in } a_2)^2 \left(\frac{\partial \phi}{\partial a_2}\right)^2 + \dots,$$

and the same law of combination holds for Mean Error (M.E.) or Error of Mean Square (E.M.S.).

1754. For example, if we require the weight of the Arithmetic Mean of n observations of equal weights ω_1 ,

$$b = \sum_1^n a_r / n \quad \text{and} \quad \frac{1}{\omega} = \frac{1}{\omega_1} \sum \frac{1}{n^2} = \frac{1}{n \omega_1}, \quad \text{i.e. } \omega = n \omega_1.$$

That is the weight of the combination is n times the weight of any of the original observations, and

the Probable Error in $b = (\text{P.E. in any of the } a\text{'s}) / \sqrt{n}$, etc.

Similarly the weight of a resultant $pa_1+qa_2+ra_3+\dots$ is given by

$$\frac{1}{\omega} = \frac{p^2}{\omega_1} + \frac{q^2}{\omega_2} + \frac{r^2}{\omega_3} + \dots;$$

and if $\omega_1=\omega_2=\omega_3=\dots$, $\frac{1}{\omega} = \frac{p^2+q^2+r^2+\dots}{\omega_1}$.

1755. If observations be taken upon a single physical element, and the *weights* and *probable errors* of the several observations (a_1, a_2, a_3, \dots) be respectively ($\omega_1, \omega_2, \omega_3, \dots$) and ($\epsilon_1, \epsilon_2, \epsilon_3, \dots$), whilst ω and ϵ are those of a *resultant* formed according to the law $\Sigma p_r a_r / \Sigma p_r$, which is the usual form adopted, where (p_1, p_2, p_3, \dots) are certain constant multipliers, called "combination weights," to be so determined as to give a minimum probable error in that resultant, we have

$$\epsilon^2 = \epsilon_1^2 \left(\frac{p_1}{\Sigma p_r} \right)^2 + \epsilon_2^2 \left(\frac{p_2}{\Sigma p_r} \right)^2 + \dots;$$

and differentiating with regard to p_1, p_2, p_3, \dots ,

$$p_1 \epsilon_1^2 = p_2 \epsilon_2^2 = p_3 \epsilon_3^2 = \dots = \Sigma p_r^2 \epsilon_r^2 / \Sigma p_r,$$

i.e. $p_1/\omega_1 = p_2/\omega_2 = p_3/\omega_3 = \dots$,

i.e. the combination weights are to be proportional to the theoretical weights. Moreover, it follows that

$$\frac{1}{\epsilon^2} = \frac{1}{\epsilon_1^2} + \frac{1}{\epsilon_2^2} + \frac{1}{\epsilon_3^2} + \dots \quad \text{or} \quad \omega = \omega_1 + \omega_2 + \omega_3 + \dots,$$

and the theoretical weight of the result is equal to the sum of the theoretical weights of the several collateral measures (see *Airy, Th. Err.*, p. 56).

1756. To estimate the actual value of the weight of a series of observations upon a single physical element, we have seen that $\frac{1}{2\omega}$ = mean of squares of the errors.

If then the actual errors of each observation were known, we should have a rule to determine ω . But the exact measurement of the quantity upon which the observations are made is rarely known. Let T be its true value, A_1, A_2, \dots, A_n the observed values. Then $A_1 - T, A_2 - T$, etc., are the *actual* errors, and $\frac{1}{2\omega} = \frac{1}{n} \sum_1^n (A_r - T)^2$. But T being unknown, we have to *approximate*. Let us adopt the arithmetical mean of the observations as the value of T , and write $T = \frac{1}{n} \sum_1^n A_r$, which

is known as the "apparent value," but is not necessarily the true one. This gives as an approximation

$$\frac{n}{2\omega} = A_1^2 + A_2^2 + \dots + A_n^2 - 2T(A_1 + A_2 + \dots) + nT^2 = \sum_1^n A_r^2 - nT^2,$$

i.e. as an *approximation* we have $\frac{1}{2\omega} = \frac{1}{n} \sum_1^n A_r^2 - \frac{1}{n^2} \left(\sum_1^n A_r \right)^2$

$$= \left(\begin{array}{c} \text{Mean of squares} \\ \text{of observations} \end{array} \right) - \left(\begin{array}{c} \text{Square of mean} \\ \text{of observations} \end{array} \right).$$

1757. Determination of the "Error of Mean Square," "Probable Error," etc., of a Measurement of an Element from the Apparent Errors.

Since the true value of the measured element is rarely or never known, we have to devise a method of obtaining the Error of Mean Square, etc., by some way other than as being $1/\sqrt{2\omega}$, which would require a knowledge of ω . Let A_1, A_2, A_3, \dots be the actual results of n independent observations on the single physical element in question, a_1, a_2, a_3, \dots the actual errors, T the true value; then $A_1 = T + a_1, A_2 = T + a_2$, etc.

Let M and m be the arithmetic means of the A 's and of the a 's. Then

$$a_r - m = A_r - T - \frac{1}{n} \sum_1^n (A_r - T) = A_r - \frac{1}{n} \Sigma A_r = A_r - M.$$

The difference $a_r - m$, viz. the difference between the actual error and the mean of the actual errors, is called the "Apparent Error." And the sum of the squares of the Apparent Errors

$$= \sum_1^n (a_r - m)^2 = \Sigma a_r^2 - 2m \cdot nm + nm^2 = \Sigma a_r^2 - \frac{1}{n} (\Sigma a_r)^2.$$

Therefore, if $Q \equiv \Sigma (A_r - M)^2$, we have $Q = \Sigma a_r^2 - \frac{1}{n} (\Sigma a_r)^2$.

Now let ϵ be the error of mean square of each measure.

Then (Art. 1750, 5) $\epsilon^2 = \frac{1}{n} \sum_1^n a_r^2$, *i.e.* $\sum_1^n a_r^2 = n\epsilon^2$.

Again, the square of $\Sigma a_r = \text{sq. of error in } \Sigma A_r$

$$= (\text{Error of mean square in } \Sigma A_r)^2$$

$$= \sum_1^n (\text{Error of mean square in } A_r)^2$$

$$= n\epsilon^2 \quad (\text{Art. 1753});$$

\therefore sum of squares of Apparent Errors $= n\epsilon^2 - \frac{1}{n} n\epsilon^2 = (n-1)\epsilon^2$.

Hence $\epsilon = \sqrt{\frac{Q}{n-1}}$; and Q being known, this determines ϵ .

Since the Error of mean square $= 1/\sqrt{2\omega}$, we have

$$\omega = (n-1)/2Q.$$

Also Mean Error $= \frac{1}{\sqrt{\pi\omega}} = \sqrt{\frac{2}{\pi} \frac{Q}{n-1}}$;

$$\text{Probable Error} = \frac{0.476948}{\sqrt{\omega}} = 0.476948 \dots \sqrt{\frac{2Q}{n-1}}.$$

1758. Again, since the Error of mean square of the mean of n independent measures of a physical quantity

$$= \frac{1}{\sqrt{n}} \times \text{Error of mean square of any one measure (Art. 1754)}$$

$$= \frac{1}{\sqrt{n}} \epsilon = \sqrt{\frac{Q}{n(n-1)}}, \text{ we also have}$$

$$\left. \begin{array}{l} \text{Mean Error} \\ \text{of the mean} \end{array} \right\} = \sqrt{\frac{2}{\pi} \frac{Q}{n(n-1)}},$$

$$\left. \begin{array}{l} \text{Probable Error} \\ \text{of the mean} \end{array} \right\} = 0.476948 \dots \sqrt{\frac{2Q}{n(n-1)}}.$$

1759. **Case of a System of Physical Elements.**

Suppose next that it is required to discover the values of a certain set of physical elements ξ, η, ζ, \dots , and that observations upon certain connected groups of them have been taken giving results of the form

$$\phi_1(\xi, \eta, \zeta, \dots) = N_1, \quad \phi_2(\xi, \eta, \zeta, \dots) = N_2, \text{ etc.},$$

the forms of ϕ_1, ϕ_2 , etc., being known, and all the constants involved being known from theoretical or other considerations, whilst N_1, N_2, \dots are the results of observation, and therefore subject to small errors.

Theoretically, if the number (m) of observations be the same as the number (μ) of elements to be found, there will be a definite number of sets of solutions of these equations depending upon the degrees of the several functions. If, however, the number of observations exceed the number of elements, it will not in general be possible to satisfy all the equations by the same values of ξ, η, ζ , etc., and it becomes important to examine a method of finding their most probable values under the circumstances.

1760. Reduction of the Equations to Linear Form.

The observed quantities N_1, N_2 , etc., will not differ largely from those which would give true values to ξ, η, ζ , etc., and if we solve μ of these equations we shall obtain close approximations to the values of ξ, η, ζ , etc., or in some cases such close approximations may be otherwise available. Let these approximate values be α, β, γ , etc., and x, y, z , etc., the small residuals of the true values of ξ, η, ζ , etc., so that $\xi = \alpha + x, \eta = \beta + y$, etc., and these residuals being small their second and higher powers and products may be rejected, and each equation of form $\phi_i(\xi, \eta, \zeta, \dots) = N_i$ may be regarded as reduced after expansion of $\phi_i(\alpha + x, \beta + y, \dots)$ by Taylor's theorem to the type

$$a_i x + b_i y + c_i z + \dots = n_i,$$

such equations being m in number. Now n_i being itself the result of the subtraction of $\phi(\alpha, \beta, \gamma, \dots)$ and various second and higher order small quantities from N_i depends upon the observations, and is a small quantity subject to error, whilst a_i, b_i, c_i, \dots are supposed known from theoretical or other considerations.

1761. The Equations of Condition.

We therefore have m linear equations connecting μ unknowns x, y, z , etc., μ being $< m$. Let a typical equation be $a_i x + b_i y + c_i z + \dots - n_i = 0$, where $i = 1, 2, 3, \dots m$. We need not for the moment consider x, y, z, \dots to be small.

These m equations are not in general capable of being satisfied by the same values of x, y, z, \dots , but we have to obtain the most probable values of x, y, z, \dots from them; that is, as good an approximation as we can under the circumstances.

These equations are called the "Equations of Condition."

1762. Standardisation of the Equations.

As to the several results of observation, n_1, n_2, n_3, \dots , let us suppose that they are each the result of several separate and independent observations; e.g. taking the typical case n_i , suppose it to have been formed as the arithmetic mean of ω_i observations upon the value of $a_i x + b_i y + \dots$, and suppose all these ω_i observations to be equally good observations. Then the weight of this observation is proportional to ω_i .

Therefore, unless the number of observations in forming n_1, n_2, n_3, \dots has been the same and the individual observations equally good, some of the Equations of Condition will have greater importance than others.

If n_i be found by ω_i observations, each with the same probable error ϵ , the probable error in n_i is $\epsilon/\sqrt{\omega_i}$, and the probable error in $n_i \cdot \sqrt{\omega_i}$ is ϵ .

Hence, if we multiply the Equations of Condition by $\sqrt{\omega_1}, \sqrt{\omega_2}, \sqrt{\omega_3}, \dots$, we get another group in which the probable errors of the right-hand sides are each ϵ .

We shall suppose our m Equations of Condition to have been already subjected to this preparation, and therefore suppose that the quantities n_1, n_2, n_3, \dots which occur are subject to the same probable error ϵ .

1763. PRINCIPLE OF LEAST SQUARES.

If x_0, y_0, z_0, \dots be the most probable values of x, y, z, \dots respectively, then, by the nature of the case,

$$a_i x_0 + b_i y_0 + c_i z_0 + \dots - n_i$$

is a small quantity of the nature of an error. Call it v_i . Then the probability of the occurrence of the error v_i being

$\sqrt{\frac{\omega_i}{\pi}} e^{-\omega_i v_i^2} dv_i$, the probability of the co-existence of errors

$v_1, v_2, \dots v_i \dots v_m$ is $\prod_1^m \sqrt{\frac{\omega_i}{\pi}} e^{-\omega_i v_i^2} dv_i$ and as these errors have

occurred through taking x_0, y_0, z_0, \dots , etc., as the true values of x, y, z, \dots , etc., the probability that x_0, y_0, \dots are the true

values is $\prod_1^m \sqrt{\frac{\omega_i}{\pi}} e^{-\omega_i v_i^2} dv_i / \int_{-\infty}^{\infty} \int_{-\infty}^{\infty} \dots \int_{-\infty}^{\infty} \prod_1^m \sqrt{\frac{\omega_i}{\pi}} e^{-\omega_i v_i^2} dv_i$, in

which the denominator is a definite constant; and, supposing the Conditional Equations to have been prepared as described in the preceding article, the ω 's occurring are all equal.

But in any case we have to determine x_0, y_0, \dots , so that this probability shall be as great as possible; and this will be

achieved by making $\sum_1^m \omega_i v_i^2$ a minimum; or, if the ω 's are

equal, $\sum v_i^2 =$ a minimum. The method of procedure is therefore called the method of "Least Squares."

1764. The "Normal" Equations.

The primary condition for a minimum is

$$\sum_1^m \omega_i v_i (a_i dx_0 + b_i dy_0 + \dots) = 0,$$

and therefore, on equating to zero the coefficients of dx_0, dy_0, \dots , we have m linear equations to determine x_0, y_0, z_0, \dots , viz

$$\sum \omega_i a_i v_i = 0, \quad \sum \omega_i b_i v_i = 0, \quad \sum \omega_i c_i v_i = 0, \quad \text{etc.};$$

or in the case when the equations have been prepared beforehand, so that the weights are equal,

$$\sum a_i v_i = 0, \quad \sum b_i v_i = 0, \quad \sum c_i v_i = 0, \quad \text{etc., i.e.};$$

$$\left. \begin{aligned} \sum a^2 \cdot x_0 + \sum ab \cdot y_0 + \sum ac \cdot z_0 + \dots &= \sum an, \\ \sum ba \cdot x_0 + \sum b^2 \cdot y_0 + \sum bc \cdot z_0 + \dots &= \sum bn, \\ \sum ca \cdot x_0 + \sum cb \cdot y_0 + \sum c^2 \cdot z_0 + \dots &= \sum cn, \\ &\text{etc.,} \end{aligned} \right\} \begin{array}{l} \text{which are known} \\ \text{as the "Normal"} \\ \text{Equations.} \end{array}$$

The very compact notation $[ab], [aa]$, etc., is often used for $\sum ab, \sum a^2$, etc., but we adopt the sigma notation as a little easier to write.

These equations determine the values of x_0, y_0 , etc., so as to give the most probable values of x, y , etc., to satisfy the original group of Conditional Equations in which the n 's are subject to small errors.

1765. Before proceeding further, let us examine the m prepared equations of type $a_i x + b_i y + c_i z + \dots = n_i$, from another point of view.

Multiply the several equations by p_1, p_2, \dots, p_m and add; then by q_1, q_2, \dots, q_m and add; then by r_1, r_2, \dots, r_m and add; and so on; viz. by μ groups of multipliers, m in each group. We obtain μ equations,

$$\left. \begin{aligned} x \sum a_i p_i + y \sum b_i p_i + z \sum c_i p_i + \dots &= \sum n_i p_i, \\ x \sum a_i q_i + y \sum b_i q_i + z \sum c_i q_i + \dots &= \sum n_i q_i, \\ x \sum a_i r_i + y \sum b_i r_i + z \sum c_i r_i + \dots &= \sum n_i r_i, \\ &\text{etc.} \end{aligned} \right\} \dots\dots\dots(1)$$

Again multiply these by $\lambda_1, \lambda_2, \dots, \lambda_\mu$ and add, and choose the λ 's so as to remove the terms y, z, \dots , i.e.

$$\left. \begin{aligned} \lambda_1 \sum b_i p_i + \lambda_2 \sum b_i q_i + \lambda_3 \sum b_i r_i + \dots &= 0, \\ \lambda_1 \sum c_i p_i + \lambda_2 \sum c_i q_i + \lambda_3 \sum c_i r_i + \dots &= 0, \\ &\text{etc.} \end{aligned} \right\}$$

Then
$$x = \frac{\lambda_1 \sum n_i p_i + \lambda_2 \sum n_i q_i + \lambda_3 \sum n_i r_i + \dots}{\lambda_1 \sum a_i p_i + \lambda_2 \sum a_i q_i + \lambda_3 \sum a_i r_i + \dots} = \frac{\sum n_i k_i}{\sum a_i k_i},$$

where $k_i = \lambda_1 p_i + \lambda_2 q_i + \lambda_3 r_i + \dots$; whilst $\sum b_i k_i = 0$, $\sum c_i k_i = 0$, etc., and the new constant multipliers k_1, k_2, k_3, \dots replace the p 's, q 's, r 's, etc., and λ 's.

Let ω be the weight of each of the observations n_1, n_2, \dots, n_m , by supposition prepared to be of equal weight, and let $\omega_x, \omega_y, \omega_z, \dots$ be the weights of the deduced values of x, y, z, \dots .

Then
$$\frac{1}{\omega_x} = \frac{\sum k_i^2}{(\sum a_i k_i)^2} \frac{1}{\omega}, \quad \text{Art. 1753.} \dots\dots\dots(2)$$

And if ϵ be the error of mean square, or the probable error in each of the n 's, and $\epsilon_x, \epsilon_y, \epsilon_z, \dots$ the resulting error of mean square, or the probable error in the deduced values of x, y, z, \dots , we therefore have $\epsilon_x^2 = \frac{\sum k_i^2}{(\sum a_i k_i)^2} \epsilon^2$, and we have to make this error of mean square, or this probable error, as small as possible with the conditions $\sum b_i k_i = 0$, $\sum c_i k_i = 0$, etc.

1766. To do this we have the k 's at our disposal. Their number is m and their connecting equations number $\mu - 1$, which is $< m$. It will be observed that the expression ϵ_x contains only the *ratios* of the k 's, and when their ratios to any particular standard k have been fixed ϵ_x becomes determinate. We shall therefore in no way alter the value of ϵ_x by the addition of some one additional linear equation amongst the k 's. For convenience we take that relation as $\sum a_i k_i = 1$, which will give $x = \sum n_i k_i$. We then have to make $\epsilon_x^2 = \sum k_i^2 \cdot \epsilon^2$ a minimum with the μ conditions $\sum a_i k_i = 1$, $\sum b_i k_i = 0$, $\sum c_i k_i = 0$, etc. We obtain at once $\sum k_i dk_i = 0$, $\sum a_i dk_i = 0$, $\sum b_i dk_i = 0$, etc., and by Lagrange's method of undetermined multipliers

$$k_1 = Aa_1 + Bb_1 + \dots, \quad k_2 = Aa_2 + Bb_2 + \dots, \quad \dots k_m = Aa_m + Bb_m + \dots,$$

whence
$$\sum k_i^2 = A \sum a_i k_i = A.$$

Also
$$\left. \begin{aligned} A \sum a^2 + B \sum ab + C \sum ac + \dots &= \sum a_i k_i = 1, \\ A \sum ba + B \sum b^2 + C \sum bc + \dots &= \sum b_i k_i = 0, \\ A \sum ca + B \sum cb + C \sum c^2 + \dots &= \sum c_i k_i = 0, \\ &\text{etc.,} \end{aligned} \right\} \dots\dots\dots(3)$$

whence $A = \left| \begin{array}{c} \Sigma b^2, \Sigma bc, \dots \\ \Sigma cb, \Sigma c^2 \dots \\ \dots \dots \dots \end{array} \right| \left| \begin{array}{c} \Sigma a^2, \Sigma ab, \Sigma ac \dots \\ \Sigma ba, \Sigma b^2, \Sigma bc \dots \\ \Sigma ca, \Sigma cb, \Sigma c^2 \dots \\ \dots \dots \dots \end{array} \right|$ and is known,

and $A = \Sigma k_i^2$. Therefore $\epsilon_x^2 = A\epsilon^2$ and $\epsilon_x = \epsilon\sqrt{A}$; and A is essentially positive, being the sum of a number of squares of real quantities. The weight of the deduced value for x is $\omega_x = \frac{1}{\Sigma k_i^2} \omega = \frac{1}{A} \cdot \omega$, and if we take ω as unity, $\omega_x = \frac{1}{A}$.

1767. The symmetry of the work shows that the same process will give us a minimum error of mean square, or a minimum probable error also for y or for z , etc., and that the weight of y so deduced may be found by solving equations of the same form as those in group (3), but with the 1 now replaced by 0 in the first equation and the 0 by 1 in the second; and so on for the weights of z , etc.

1768. Again it will be noticed that if we choose our preliminary multipliers, viz. the p 's, q 's, r 's, etc., as the coefficients of the original prepared conditional equations, viz. $p_i = a_i$, $q_i = b_i$, $r_i = c_i$, etc., we have $k_i = \lambda_1 a_i + \lambda_2 b_i + \lambda_3 c_i + \dots$, and for this choice

$$\Sigma k_i^2 = \Sigma (\lambda_1 a_i + \lambda_2 b_i + \dots) k_i = \lambda_1 \Sigma a_i k_i + \lambda_2 \Sigma b_i k_i + \dots = \lambda_1 = A.$$

That is, substituting for the p 's, q 's, r 's, ... in equations of group (1), the equations which will give a value of x with the least error of mean square, or least probable error for x are the "normal" equations arrived at in Art. 1764. otherwise, and the symmetry shows that the values of y , z , etc., will also be determined by the same equations with the least error. But as these equations are the same as those arrived at by making $\Sigma (a_i x + b_i y + \dots - n_i)^2$ a minimum by variation of x, y, z, \dots , this is a convenient way of reproducing the equations for these unknowns. And the result is the same as that arrived at in Art. 1764, the weights of the several observations having been made equal by preparation of the conditional equations.

1769. If the conditional equations are left unprepared, we arrive at the proper equations for the values of x, y, z , etc., by making $\Sigma \omega_i (a_i x + b_i y + \dots - n_i)^2$ a minimum.

1770. Reality of \sqrt{A} .

The determinants occurring in Art. 1766 are essentially positive. For such a determinant as

$$\left| \begin{array}{cccc} \Sigma a^2, & \Sigma ab, & \Sigma ac, & \dots \\ \Sigma ba, & \Sigma b^2, & \Sigma bc, & \dots \\ \Sigma ca, & \Sigma cb, & \Sigma c^2, & \dots \\ \dots\dots\dots & & & \dots \end{array} \right| \text{ occurs in squaring } \left| \begin{array}{cccc} a_1, & a_2, & \dots & a_m \\ b_1, & b_2, & \dots & b_m \\ c_1, & c_2, & \dots & c_m \\ \dots\dots\dots & & & \dots \end{array} \right|$$

in which the number of rows (μ) is less than the number of columns (m), and is therefore expressible as the sum of the squares of all possible determinants which can be formed from the array by taking μ columns (Burnside & Panton, *Th. of Eq.*, p. 260). Such a determinant is therefore essentially positive.

1771. To complete the theory we must examine how the quantity ϵ is to be found from the details before us; that is, we are to do for the case of measurements upon a system of physical elements what was done in Art. 1757 for the measurement of a single element. We have used ϵ indifferently in Art. 1765, etc., for either the error of mean square, the probable error or the mean error. We shall now define the letter as standing definitely for the "error of mean square" in the measure of an observation. Let v_i be the residual error in $a_i x + b_i y + \dots - n_i$, when the values x_0, y_0, z_0, \dots obtained from the "normal" equations have been substituted for x, y, z, \dots .

Then we shall show that the equation $\epsilon = \sqrt{\frac{\Sigma v_i^2}{m - \mu}}$ replaces that of Art. 1757.

Let the true values of x, y, z, \dots be $x_0 + \delta x, y_0 + \delta y, z_0 + \delta z, \dots$, and let

$$a_i(x_0 + \delta x) + b_i(y_0 + \delta y) + \dots - n_i = u_i \quad (i=1 \text{ to } i=m).$$

Multiply by a_i and add the system. Then

$$\left. \begin{array}{l} \Sigma a^2 . x_0 + \Sigma ab . y_0 + \Sigma ac . z_0 + \dots - \Sigma an \\ + \Sigma a^2 . \delta x + \Sigma ab . \delta y + \Sigma ac . \delta z + \dots \\ \therefore \Sigma a^2 . \delta x + \Sigma ab . \delta y + \Sigma ac . \delta z + \dots \\ \text{Similarly } \Sigma ba . \delta x + \Sigma b^2 . \delta y + \Sigma bc . \delta z + \dots \\ \Sigma ca . \delta x + \Sigma cb . \delta y + \Sigma c^2 . \delta z + \dots \end{array} \right\} \begin{array}{l} = \Sigma au ; \\ = \Sigma au . \\ = \Sigma bu , \\ = \Sigma cu , \text{ etc.} , \end{array}$$

which, as in Arts. 1765, 1766, give $\delta x = \Sigma ku$.

1772. Equations of type $a_i x_0 + b_i y_0 + \dots - n_i = v_i (i=1 \text{ to } i=m)$, multiplied by v_i and added, give $\Sigma v_i^2 = -\Sigma n_i v_i$, since

$$\Sigma a v = 0, \quad \Sigma b v = 0, \quad \Sigma c v = 0, \quad \text{etc.}$$

And equations of type $a_i(x_0 + \delta x) + b_i(y_0 + \delta y) + \dots - n_i = u_i$ give in the same way $\Sigma u_i v_i = -\Sigma n_i v_i$.

Hence
$$\Sigma v_i^2 = \Sigma u_i v_i = -\Sigma n_i v_i.$$

1773. Equations $a_i x_0 + b_i y_0 + c_i z_0 + \dots - n_i = v_i$, multiplied by u_i and added, give

$$\Sigma a_i u_i \cdot x_0 + \Sigma b_i u_i \cdot y_0 + \dots - \Sigma n_i u_i = \Sigma v_i u_i = \Sigma v_i^2.$$

Equations $a_i(x_0 + \delta x) + b_i(y_0 + \delta y) + \dots - n_i = u_i$, multiplied by u_i and added, give

$$\begin{aligned} \Sigma a_i u_i \cdot x_0 + \Sigma b_i u_i \cdot y_0 + \dots - \Sigma n_i u_i \\ + \Sigma a_i u_i \cdot \delta x + \Sigma b_i u_i \cdot \delta y + \dots \end{aligned} = \Sigma u_i^2.$$

Hence $\Sigma u_i^2 = \Sigma v_i^2 + \Sigma a_i u_i \cdot \delta x + \Sigma b_i u_i \cdot \delta y + \Sigma c_i u_i \cdot \delta z + \dots$

And, since Σu_i^2 is the sum of the squares of the true errors of the observations, $\Sigma u_i^2 = m\epsilon^2$.

Now, in the terms $\Sigma a_i u_i \cdot \delta x + \Sigma b_i u_i \cdot \delta y + \dots$, we must necessarily approximate.

Take for them their mean values. Then

$$\Sigma a_i u_i \cdot \delta x = (a_1 u_1 + a_2 u_2 + a_3 u_3 + \dots)(k_1 u_1 + k_2 u_2 + k_3 u_3 + \dots),$$

whose mean value is that of $a_1 k_1 u_1^2 + a_2 k_2 u_2^2 + a_3 k_3 u_3^2 + \dots$; for, remembering that the errors u_1, u_2, u_3, \dots may have either sign, all products involving errors with unequal suffixes will disappear in taking the mean. And the mean values of $u_1^2, u_2^2, u_3^2, \dots$ are each ϵ^2 .

Hence $\Sigma a_i u_i \cdot \delta x$ will be replaced by $\Sigma a_i k_i \cdot \epsilon^2$, that is ϵ^2 .

Similarly $\Sigma b_i u_i \cdot \delta y, \Sigma c_i u_i \cdot \delta z, \dots$ will be replaced by ϵ^2 .

Therefore $m\epsilon^2 = \Sigma v_i^2 + \mu\epsilon^2$, μ being the number of unknowns x, y, z, \dots

Hence
$$\epsilon^2 = \frac{\Sigma v_i^2}{m - \mu}.$$

1774. If there be but one unknown, *i.e.* when the observations are made upon a single physical element, we have

$$\epsilon^2 = \frac{\Sigma v_i^2}{m - 1}. \quad (\text{Art. 1757.})$$

1775. Effect of Exact Co-existent Relations.

If, in addition to the m conditional equations of type

$$a_i x + b_i y + \dots - n_i = 0,$$

there be p ($< \mu$) exact equations of type

$$\alpha_i x + \beta_i y + \dots - \nu_i = 0,$$

these latter equations may be regarded as determining p of the unknowns in terms of the other $\mu - p$. Upon substitution of these in the conditional equations, we have a system of m conditional equations amongst $\mu - p$ unknowns. Hence the error of mean square ϵ will in this case be given by $\epsilon = \sqrt{\frac{\sum v_i^2}{m + p - \mu}}$, where v_i is, as before, $a_i x_0 + b_i y_0 + \dots - n_i$, and the summation is from $i=1$ to $i=m$.

If μ be large, or if there be several exact equations, a different process is usually employed to reduce the labour of the elimination. (For this see Chauvenet, *Astron.*, p. 552, Vol. II.)

1776. Finally, if $\epsilon_x, \epsilon_y, \epsilon_z, \dots$ be the errors of mean square in x_0, y_0, z_0, \dots , and if X, Y, Z, \dots be the respective weights of x_0, y_0, z_0, \dots , then $\epsilon_x = \frac{\epsilon}{\sqrt{X}}$, $\epsilon_y = \frac{\epsilon}{\sqrt{Y}}$, etc., and the values of X, Y, Z, \dots are to be determined as follows (Art. 1766):

$$\left. \begin{aligned} \text{For } X: \quad & \Sigma a^2 \cdot \frac{1}{X} + \Sigma ab \cdot \frac{1}{Y'} + \Sigma ac \cdot \frac{1}{Z'} + \dots = 1, \\ & \Sigma ba \cdot \frac{1}{X} + \Sigma b^2 \cdot \frac{1}{Y'} + \Sigma bc \cdot \frac{1}{Z'} + \dots = 0, \\ & \Sigma ca \cdot \frac{1}{X} + \Sigma cb \cdot \frac{1}{Y'} + \Sigma c^2 \cdot \frac{1}{Z'} + \dots = 0, \\ & \text{etc.;} \end{aligned} \right\}$$

$$\left. \begin{aligned} \text{For } Y: \quad & \Sigma a^2 \cdot \frac{1}{X''} + \Sigma ab \cdot \frac{1}{Y} + \Sigma ac \cdot \frac{1}{Z''} + \dots = 0, \\ & \Sigma ba \cdot \frac{1}{X''} + \Sigma b^2 \cdot \frac{1}{Y} + \Sigma bc \cdot \frac{1}{Z''} + \dots = 1, \\ & \Sigma ca \cdot \frac{1}{X''} + \Sigma cb \cdot \frac{1}{Y} + \Sigma c^2 \cdot \frac{1}{Z''} + \dots = 0, \\ & \text{etc.,} \end{aligned} \right\}$$

the accented unknowns of each group not being required; and such equations may obviously be written down from the normal equations.

Hence we obtain X , *i.e.* the value of $\frac{1}{A}$ (Art. 1766), etc.

Moreover, in cases where the values of x_0, y_0, z_0, \dots are expressed in terms of letters and not numerically, their weights may be obtained more readily, as in Art. 1753, by differentiation.

This completes the details of the process to obtain the Mean Square error for each element, and the Probable and Mean errors may be at once deduced.

1777. Order of Procedure.

To sum up, the order of procedure is as follows :

I. Given the m conditional equations amongst μ unknowns ($m > \mu$) of type $a_i x + b_i y + c_i z + \dots - n_i = 0$, let each have been prepared by multiplication by the square root of its weight, *viz.* $\sqrt{\omega_i}$.

II. From these prepared equations, or by differentiating

$$\Sigma(a_i x + b_i y + \dots - n_i)^2,$$

deduce the normal equations and find x_0, y_0, z_0, \dots .

III. Form $\Sigma v_i^2 \equiv \Sigma(a_i x_0 + b_i y_0 + \dots - n_i)^2$.

IV. Find ϵ , the error of Mean Square of an observation from $\epsilon = \sqrt{\frac{\Sigma v_i^2}{m - \mu}}$.

V. Then to find $\epsilon_x, \epsilon_y, \epsilon_z$, etc., in the normal equations replace $\Sigma an, \Sigma bn, \Sigma cn, \dots$ by 1, 0, 0, etc., and solve for x , say $x = \frac{1}{X}$; then replace $\Sigma an, \Sigma bn, \Sigma cn, \dots$ by 0, 1, 0, ..., etc., and solve for y , say $y = \frac{1}{Y}$, and so on; then X, Y, Z, \dots are the several weights of x_0, y_0, z_0, \dots , and the errors of Mean Square are $\epsilon_x = \frac{\epsilon}{\sqrt{X}}, \epsilon_y = \frac{\epsilon}{\sqrt{Y}}, \dots$.

These values may also be obtained by Art. 1753 without the trouble of solving the normal equations when the results of the observations are given in letters instead of numerical quantities.

VI. Having found $\epsilon, \epsilon_x, \epsilon_y, \epsilon_z, \dots$, we may then deduce the Probable Error or the Mean Error by Art. 1752.

1778. For further information, the reader may consult the appendix to Vol. II. of Chauvenet's *Sph. and Practical Astronomy*.

For those interested in the Bibliography of the subject, reference may be made to

Legendre, *Nouvelles Méthodes pour la détermination des orbites des Comètes*, 1806.

Gauss, *Theoria Motus Corporum Coelestium*, 1809.

Disquisitio de Elementis Ellipt. Palladis, 1811, etc.

Bertrand, *Méthode des moindres carrées*, 1855.

Encke, *Ueber der Meth. d. Klein. Quad.*, Berlin (*Astr. Year Book*, 1834, etc.).

Laplace, *Théorie analytique des Probabilités*.

Poisson, *Sur la probabilité des resultats moyens des observations (Connaissance des Temps*, 1827).

Bessel, *Astron. Nach.* (357, 358, 399).

Hansen, Do. (192, 292, etc.).

Peirce, *Astron. Journal* (Camb. Mass., Vol. II.).

Liagre, *Calc. des Prob.*, Brussels, 1852.

And other references have been made to the works of Airy, Glaisher and Merriman in the course of this chapter.

1779. ILLUSTRATIVE EXAMPLES.

1. Suppose O a central station on a plain, and A, B, C, D four distant points. Let the angles AOB, BOC, COD, DOA be respectively estimated by p, q, r, s , equally good measurements to be $\alpha, \beta, \gamma, \delta$; and suppose that after all due care has been taken $\alpha + \beta + \gamma + \delta$ falls a little short of 360° , say by k'' . It is required to find the corrections to be applied to the several observations.

Suppose the true values of the several angles to be $\alpha + x'', \beta + y'', \gamma + z'', \delta + w''$.

Then $x + y + z + w = k$ is an exact equation. The equations of condition are $x = 0, y = 0, z = 0, x + y + z - k = 0$, which cannot be satisfied simultaneously. Making $px^2 + qy^2 + rz^2 + s(x + y + z - k)^2$ a minimum, we have $px = qy = rz = -s(x + y + z - k) = \lambda$, say. These are the Normal Equations.

Thus $x = \frac{\lambda}{p}, y = \frac{\lambda}{q}, z = \frac{\lambda}{r}$ and $\lambda \left(\frac{1}{p} + \frac{1}{q} + \frac{1}{r} \right) = k - \frac{\lambda}{s}$; i.e. $\lambda = \frac{k}{\frac{1}{p} + \frac{1}{q} + \frac{1}{r} + \frac{1}{s}}$;

whence $x = \frac{k}{p} \left/ \sum \frac{1}{p} \right., y = \frac{k}{q} \left/ \sum \frac{1}{p} \right., z = \frac{k}{r} \left/ \sum \frac{1}{p} \right., w = \frac{k}{s} \left/ \sum \frac{1}{p} \right.,$

which give the probable values of x, y, z, w .

2. Let p observations of the zenith distance of a circumpolar star be made at the upper culmination, and q at the lower. It is required to find the co-latitude of the place. [AIRY, p. 42, *Errors of Observation*.]

Let a and b be the means of the two sets of observations. Then $z_1 = a$ and $z_2 = b$ are the estimated zenith distances at the two culminations. And we are to find the probable error in $\frac{1}{2}(a + b)$, which would be the true co-latitude if the means of the observations were accurate.

Let ω be the weight of any of the original observations, all supposed of equal value; ω' the weight of $\frac{1}{2}(a+b)$. Then

$$\frac{1}{\omega'} = \frac{1}{4} \frac{1}{p\omega} + \frac{1}{4} \frac{1}{q\omega} = \frac{1}{4\omega} \frac{p+q}{pq}.$$

Hence if ϵ and ϵ' be the probable errors of an observation and of the deduced co-latitude, $\epsilon' = \frac{1}{2} \sqrt{\frac{p+q}{pq}} \epsilon$, with the same formula connecting the errors of mean square and the mean errors.

3. Consider a rod, whose accurate weight is h grammes, to be broken into three random pieces of unknown weights x, y, z grammes; y and z are weighed together l times; z and x , m times; x and y , n times, and the means of the three sets of weighings are a, b and c grammes, and all the weighings are equally good observations so far as is known. It is required to find the most probable weights of the several parts and the probable error in each.

[MATH. TRIP., 1876.]

Here $x+y+z=h$, (1); $y+z=a$, (2); $z+x=b$, (3); $x+y=c$, (4).

Equation (1) is exact. The others are subject to error. Let ω be the "weight" of any one observation. The "weights" of the means are $l\omega, m\omega, n\omega$. The equations (2), (3), (4) may be written $h-x-a=0, h-y-b=0, h-z-c=0$, and we are to make

$$l(h-x-a)^2 + m(h-y-b)^2 + n(h-z-c)^2 \\ = \text{a minimum with condition } x+y+z=h.$$

Thus, $l(h-x-a)dx + \dots = 0, dx + \dots = 0$, whence $l(h-x-a) = \dots = \dots = \lambda$, i.e. $3h - (x+y+z) - a - b - c = \lambda\left(\frac{1}{l} + \frac{1}{m} + \frac{1}{n}\right)$, i.e. $2h - a - b - c = \lambda\left(\frac{1}{l} + \dots\right)$,

$$\text{i.e. } x = h - a - (2h - a - b - c) \frac{mn}{mn + nl + lm}, \quad y = \text{etc.}, \quad z = \text{etc.}$$

If ω_x be the "weight" of this expression for x ,

$$\frac{1}{\omega_x} = \frac{1}{\omega l} \left(\frac{\partial x}{\partial a}\right)^2 + \frac{1}{\omega m} \left(\frac{\partial x}{\partial b}\right)^2 + \frac{1}{\omega n} \left(\frac{\partial x}{\partial c}\right)^2 = \text{etc.} = \frac{1}{\omega} \frac{m+n}{mn + nl + lm}.$$

Now h being known exactly, $2h - a - b - c$ is a known error, and it is the only known error, and if Ω be the "weight" of this expression $\frac{1}{\Omega} = \frac{1}{\omega l} + \frac{1}{\omega m} + \frac{1}{\omega n}$ (Art. 1753), and $\frac{1}{2\Omega} = (2h - a - b - c)^2$ (Art. 1750). The latter equation is the approximative one for Ω . Hence

$$\frac{1}{\omega} = \frac{2lmn}{mn + nl + lm} (2h - a - b - c)^2, \quad \frac{1}{\omega_x} = \frac{2lmn(m+n)}{(mn + nl + lm)^2} (2h - a - b - c)^2.$$

The probable error for x , viz. p , is such that

$$\sqrt{\frac{\omega_x}{\pi}} \int_0^p e^{-\omega_x x^2} dx = \frac{1}{4} \quad \text{and} \quad p = \frac{.4769\dots}{\sqrt{\omega_x}},$$

$$\text{i.e. } p = .4769\dots \times \frac{\sqrt{2lmn(m+n)}}{mn + nl + lm} (2h - a - b - c).$$

Suppose in the same example that h were not known, but that the several observations are $(a_1, a_2, \dots, a_l), (b_1, b_2, \dots, b_m), (c_1, c_2, \dots, c_n)$.

We then have l equations of type $y+z-a_r=0$, m of type $z+x-b_r=0$, n of type $x+y-c_r=0$.

Then x, y, z are to be found from making

$$\sum_1^l (y+z-a_r)^2 + \sum_1^m (z+x-b_r)^2 + \sum_1^n (x+y-c_r)^2 \text{ a minimum;}$$

$$\left. \begin{aligned} \text{from which } (m+n)x_0 + ny_0 + mz_0 &= \sum_1^m b_r + \sum_1^n c_r, \\ nx_0 + (n+l)y_0 + lz_0 &= \sum_1^n c_r + \sum_1^l a_r, \\ mx_0 + ly_0 + (l+m)z_0 &= \sum_1^l a_r + \sum_1^m b_r, \end{aligned} \right\} \begin{array}{l} x_0, y_0, z \text{ being the values} \\ \text{which give the minimum.} \end{array}$$

We then have as an approximation

$$\frac{1}{2\omega} = \frac{\sum_1^l (y_0 + z_0 - a_r)^2 + \sum_1^m (z_0 + x_0 - b_r)^2 + \sum_1^n (x_0 + y_0 - c_r)^2}{l+m+n}.$$

4. A, B, C, D are four points in order on a straight line; AB, BC, CD, AC, BD, AD are measured respectively $a, \beta, \gamma, \delta, \epsilon, \zeta$ times with mean respective measurements a, b, c, d, e, f . Find the most probable value of AB ; and if $a = \beta = \gamma = \delta = \epsilon = \zeta$, find its probable error. (MATH. TRIP., 1878.)

Let $AB = x, BC = y, CD = z$; then we are to find a minimum for $\alpha(x-a)^2 + \beta(y-b)^2 + \gamma(z-c)^2 + \delta(x+y-d)^2 + \epsilon(y+z-e)^2 + \zeta(x+y+z-f)^2$

The conditions are:

$$\left. \begin{aligned} \alpha(x-a) + \delta(x+y-d) + \zeta(x+y+z-f) &= 0, \\ \beta(y-b) + \delta(x+y-d) + \epsilon(y+z-e) + \zeta(x+y+z-f) &= 0, \\ \gamma(z-c) + \epsilon(y+z-e) + \zeta(x+y+z-f) &= 0, \end{aligned} \right\} \begin{array}{l} \text{which determine} \\ x, y, z. \end{array}$$

In the case $\alpha = \beta = \text{etc.}$, these become

$$3x + 2y + z = a + d + f, \quad 2x + 4y + 2z = b + d + e + f, \quad x + 2y + 3z = c + e + f;$$

whence

$$\begin{aligned} x &= \frac{1}{4}(2a - b + d - e + f); & y &= \frac{1}{4}(-a + 2b - c + d + e); & z &= \frac{1}{4}(-b + 2c - d + e + f), \\ \text{i.e. } x - a &= \frac{1}{4}(-2a - b + d - e + f), & x + y - d &= \frac{1}{4}(a + b - c - 2d + f), \\ y - b &= \frac{1}{4}(-a - 2b - c + d + e), & y + z - e &= \frac{1}{4}(-a + b + c - 2e + f), \\ z - c &= \frac{1}{4}(-b - 2c - d + e + f), & x + y + z - f &= \frac{1}{4}(a + c + d + e - 2f), \end{aligned}$$

and the sum of the squares of these six expressions is, say K .

We also have

$$\frac{1}{\omega_x} = \frac{1}{16}(4+1+1+1+1)\frac{1}{\omega}, \quad \frac{1}{\omega_y} = \frac{1}{16}(1+4+1+1+1)\frac{1}{\omega},$$

$$\frac{1}{\omega_z} = \frac{1}{16}(1+4+1+1+1)\frac{1}{\omega},$$

i.e. $\omega_x = 2\omega, \omega_y = 2\omega, \omega_z = 2\omega$ by (Art. 1753), or they may be derived as in Art. 1776.

$$\text{Now } \frac{1}{\omega} = \sqrt{\frac{K}{6-3}} = \sqrt{\frac{K}{3}} \text{ (Art. 1773); } \therefore \frac{1}{\omega_x} = \frac{1}{\omega_y} = \frac{1}{\omega_z} = \frac{1}{2}\sqrt{\frac{K}{3}};$$

whence the Mean Errors, Mean Square Errors and Probable Errors of x, y, z may be at once written down.

[See *Sol. S.H. Prob.*, Glaisher, 1878, p. 165.]

PROBLEMS.

1. In a plane triangle the angles A , B , C are respectively measured m , n and p times, and the means of these measurements are respectively α , β and γ , and $\alpha + \beta + \gamma = \pi + \epsilon$. The separate measurements are equally good. Show that if $\alpha + x$, $\beta + y$, $\gamma + z$ be the true values of the angles, the probable values of x , y , z are

$$-np\epsilon/\delta, \quad -pm\epsilon/\delta, \quad -mn\epsilon/\delta, \quad \text{where } \delta = np + pm + mn.$$

2. In the plane triangle ABC , the side b is to be determined in terms of a from the measured values of B and C . Find the actual error in the determination of b in terms of the actual errors of measurement of B and C , and the probable error of b in terms of the probable error of any measurement supposed to be the same for the measurement of any angle. Show that of all the directions in which the side b can be drawn, that gives the probable error of the determination of its length a minimum for which the angle C satisfies the equation

$$ab(2a^2 + 3b^2)(1 + \cos^2 C) = (a^4 + 7a^2b^2 + 2b^4) \cos C.$$

[MATH. TRIPOS.]

3. At Pine Mount, a station in the U. S. Coast Survey, the angles subtended by four surrounding stations A , B , C , D were observed as follows :

AB , weight 3, $65^\circ 11' 52'' \cdot 500$; CD , weight 3, $87^\circ 2' 24'' \cdot 703$;

BC , weight 3, $66^\circ 24' 15'' \cdot 553$; DA , weight 1, $141^\circ 21' 21'' \cdot 757$.

The five points are in one plane. It is required to estimate the corrected values of these angles. The result is that the several results in the seconds should be $53'' \cdot 4145$, $16'' \cdot 4675$, $25'' \cdot 6175$, $24'' \cdot 5005$, the degrees and minutes being unaltered.

[CHAUVENET, *Astron.*, II., p. 551.]

4. Taking the equations

$$x - y + 2z - 3 = 0, \quad 4x + y + 4z - 21 = 0,$$

$$3x + 2y - 5z - 5 = 0, \quad -x + 3y + 3z - 14 = 0,$$

show that (1) the probable values of x , y , z are $2 \cdot 470$, $3 \cdot 551$, $1 \cdot 916$ respectively;

(2) the weights of x , y , z are $24 \cdot 597$, $13 \cdot 648$, $53 \cdot 927$;

(3) the error of mean square of an observation, *i.e.* of the numbers 3, 5, 21, 14, is $0 \cdot 284$;

(4) the errors of mean square of x , y , z are $0 \cdot 057$, $0 \cdot 077$, $0 \cdot 039$;

(5) the probable errors of an observation and of x, y, z are respectively 0.192, 0.038, 0.052, 0.026.

[GAUSS, *Th. Motus*; CHAUVENET, II., p. 521.]

5. In finding the latitude of a place by observation of two meridian altitudes of a circumpolar star, p observations are made at the upper transit, q at the lower. Taking the probable error of each observation at the upper transit as ϵ_1 , and at the lower as ϵ_2 , and all astronomical and instrumental corrections to have been applied, show that the probable error in the determination of the latitude is $\sqrt{p\epsilon_2^2 + q\epsilon_1^2} / \sqrt{2pq}$.

6. If the altitudes of the upper and lower transits of several circumpolar stars be observed and H_1, H_2, H_3, \dots be the harmonic means of the numbers of observations at the upper and lower transits for the several stars, and all observations be equally trustworthy, with a common probable error ϵ , supposing all astronomical and instrumental corrections to have been applied, show that the probable error in the determination of the latitude will be $\frac{\epsilon}{\sqrt{2}} [\Sigma H]^{-\frac{1}{2}}$.

7. At three stations P, Q, R on the same meridian, the zenith distances of n_1 stars are observed at each of the stations P, Q, R ; n_2 at P and Q ; n_3 at Q and R ; n_4 at R and P . It is required to determine the amplitude of the portion PQ of the meridian. Show that there are four independent modes of determining that arc; and on the supposition that the probable error of each observation is the same and $=\epsilon$, show how to determine the combination weights of the four measures. If $n_1 = n_2 = n_3 = n_4 = n$, show that the square of the probable error in the result $= \frac{4}{5} \frac{\epsilon^2}{n}$.

8. State the criterion for the selection of the combination weights of n independent measures of a magnitude. Determine the probable error of the result in terms of the probable errors of the n measures.

In the observation of the zenith distances of stars for the amplitude of a meridian divided into four sections by three stations intermediate between the extreme stations, a stars are observed at the first, second, third only; b at the second, third, fourth; c at the third, fourth, fifth; and the probable error of every observation is ϵ . Show that there are only three independent modes of measuring the whole arc, and obtain equations for determining the combination weights of the three measures. In the case where $a = b = c$, prove that the square of the probable error of the result is $10\epsilon^2/3a$.

[MATH. TRIP.]

9. If a, b, c, \dots be the actual errors in n measures of a physical element, the apparent error of each measure is defined as the difference of each measure from the mean.

Let Q be the sum of the squares of the apparent errors. Then prove that (i) the Probable error of a measure, (ii) the Mean error of a measure, (iii) the Probable error of the Mean and (iv) the Mean error of the Mean are respectively

$$0.674506 \sqrt{\frac{Q}{n-1}}, \quad 0.797885 \sqrt{\frac{Q}{n-1}},$$

$$0.674506 \sqrt{\frac{Q}{n(n-1)}}, \quad 0.797885 \sqrt{\frac{Q}{n(n-1)}}.$$

10. If we have any number of sets of n observations of the value of a physical element, all of which are *a priori* supposed to be equally good, and if the difference between any observation and the mean of the set of n observations to which it belongs be called the apparent error of that observation, then, assuming the usual law of frequency of errors, prove that the mean of the squares of the apparent errors $= \frac{n-1}{n} m^2$, where m^2 is the mean value of the square of an actual error of observation. [SMITH'S PRIZES.]

11. A rod of known length l is broken into four portions. The lengths x, y, z, w of these portions are measured respectively p, q, r, s times under the same circumstances and with the same care. The means of these several measurements are $\alpha, \beta, \gamma, \delta$. Show that the probable length of x is $\alpha + .6745 \frac{l - (\alpha + \beta + \gamma + \delta)}{\Sigma p^{-1}} \sqrt{\frac{1}{p} \left(\frac{1}{q} + \frac{1}{r} + \frac{1}{s} \right)}$.

12. The angles of a geodetic triangle of known spherical excess are measured, and the probable errors of the several measurements are $\epsilon_1, \epsilon_2, \epsilon_3$ respectively. It is found that the sum of the three measurements needs a correction of θ'' . Show that if $\alpha'', \beta'', \gamma''$ be the corrections to be applied to the angles,

$$\alpha/\epsilon_1^2 = \beta/\epsilon_2^2 = \gamma/\epsilon_3^2 = \theta/(\epsilon_1^2 + \epsilon_2^2 + \epsilon_3^2).$$

CHAPTER XXXIX.

THEOREMS OF STOKES AND GREEN. INTRODUCTION TO HARMONIC ANALYSIS.

1780. It is proposed to give in this chapter several theorems of the Integral Calculus which are of especial service in the higher branches of Physical Analysis.

1781. STOKES' THEOREM.

Let X, Y, Z be the components referred to rectangular axes Ox, Oy, Oz of any vector quantity U . Then the line integral of this vector taken along a given path on any given surface from a fixed point A to another fixed point B is

$$I_{AB} \equiv \int \left(X \frac{dx}{ds} + Y \frac{dy}{ds} + Z \frac{dz}{ds} \right) ds = \int (X dx + Y dy + Z dz).$$

Let us deform this path into an adjacent arbitrary path from A to B on the surface.

Then $\delta X = \frac{\partial X}{\partial x} \delta x + \dots$, $dX = \frac{\partial X}{\partial x} dx + \dots$, and

$$\begin{aligned} \delta I_{AB} &= \int_A^B \{ (\delta X dx + \dots) + (X d\delta x + \dots) \} \\ &= \int_A^B (\delta X dx + \dots) + [X \delta x + \dots]_A^B - \int_A^B (dX \delta x + \dots) \\ &= \int_A^B \{ (\delta X dx - dX \delta x) + \dots \} \\ &= \int_A^B \left\{ \left(\frac{\partial Z}{\partial y} - \frac{\partial Y}{\partial z} \right) (\delta y dz - \delta z dy) + \left(\frac{\partial X}{\partial z} - \frac{\partial Z}{\partial x} \right) (\delta z dx - \delta x dz) \right. \\ &\quad \left. + \left(\frac{\partial Y}{\partial x} - \frac{\partial X}{\partial y} \right) (\delta x dy - \delta y dx) \right\}. \end{aligned}$$

But if P, Q be adjacent points $(x, y, z), (x+dx, y+dy, z+dz)$ on the path $APQB$, and P', Q' the points to which they are deformed, having coordinates $(x+\delta x, \text{etc.})$, and to the first order $(x+dx+\delta x, \text{etc.})$, these four points are to that order the corners of a parallelogram the area of whose projection upon the plane of $y-z$ is $\delta y dz - \delta z dy$.

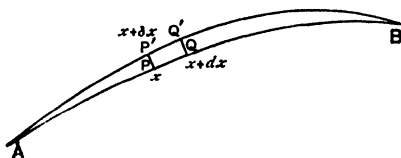

Fig. 588.

Let dS be the area of the element $PQ'Q'P'$; l, m, n the direction cosines of the normal to the surface at x, y, z . Then to the second order

$$\delta y dz - \delta z dy = l dS, \quad \delta z dx - \delta x dz = m dS, \quad \delta x dy - \delta y dx = n dS.$$

Therefore the variation in the line integral along $APQB$ by deformation into $AP'Q'B$ is

$$\delta I = \iint \left[l \left(\frac{\partial Z}{\partial y} - \frac{\partial Y}{\partial z} \right) + m \left(\frac{\partial X}{\partial z} - \frac{\partial Z}{\partial x} \right) + n \left(\frac{\partial Y}{\partial x} - \frac{\partial X}{\partial y} \right) \right] dS,$$

the integration being for all the elements of S which lie between the two paths.

If we enlarge the strip by taking a new variation of the path $AP'Q'B$ to an adjacent path $AP''Q''B$, the extra increase is the same integral taken over the area between the second and third paths; and this process may be followed by other deformations to any extent so long as X, Y, Z and their differential coefficients remain single-valued, finite and continuous in the deformation (Fig. 589).

If then A and B be any two points upon a contour $ACBD$ drawn upon the surface within which contour X, Y, Z and their differential coefficients are at all points single-valued, finite and continuous, the difference of the line integral along ACB and that along ADB is measured by the surface integral $\iint \left[l \left(\frac{\partial Z}{\partial y} - \frac{\partial Y}{\partial z} \right) + m \left(\frac{\partial X}{\partial z} - \frac{\partial Z}{\partial x} \right) + n \left(\frac{\partial Y}{\partial x} - \frac{\partial X}{\partial y} \right) \right] dS$, taken over the whole surface bounded by the contour. Also the line integral from A to B along $ADB = -$ the line integral along BDA (Fig. 590).

Hence the line integral round the whole contour is equal to the surface integral $\int \left[l \left(\frac{\partial Z}{\partial y} - \frac{\partial Y}{\partial z} \right) + + \right] dS$, over the whole area bounded by the contour.

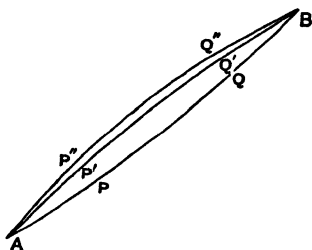

Fig. 589.

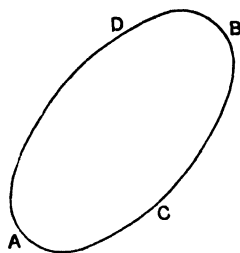

Fig. 590.

Now let R be some vector quantity whose components $2\xi, 2\eta, 2\xi$ are such that

$$2\xi = \frac{\partial Z}{\partial y} - \frac{\partial Y}{\partial z}, \quad 2\eta = \frac{\partial X}{\partial z} - \frac{\partial Z}{\partial x}, \quad 2\xi = \frac{\partial Y}{\partial x} - \frac{\partial X}{\partial y};$$

then we have

$$\int \left(X \frac{dx}{ds} + Y \frac{dy}{ds} + Z \frac{dz}{ds} \right) ds \left(\begin{array}{l} \text{taken round} \\ \text{the contour} \end{array} \right) = 2 \iint (l\xi + m\eta + n\xi) dS,$$

taken over the bounded surface.

But $2(l\xi + m\eta + n\xi)$ is the component of the vector R along the normal $= R \cos \epsilon$, say, where ϵ is the angle between the normal to the surface and the direction of R ; and if ϵ' be the angle between the vector U and the tangent to the contour

$$X \frac{dx}{ds} + Y \frac{dy}{ds} + Z \frac{dz}{ds} = U \cos \epsilon'.$$

Hence $\iint R \cos \epsilon dS = \int U \cos \epsilon' ds$, a result due to Stokes and of the highest importance in Higher Physics. [See Lamb, *Hydrodyn.*, Art. 33.]

It is remarkable that the surface integral is independent of the form of the surface, and depends only upon the line integral round the bounding edge, so that it is the same for all diaphragms with a given edge; provided that in the deformation from any one diaphragm to any other no point in space is passed for which X, Y, Z or any of their first order differential coefficients cease to be single-valued, finite and continuous.

1782. GREEN'S THEOREM.* LORD KELVIN'S EXTENSION.

Let V_1 and V_2 be any two functions of x, y, z , the coordinates of a point P , and α any quantity, constant for Green's Theorem, or any function of the variables for Lord Kelvin's extension, and suppose all three functions and their differential coefficients to be single-valued, finite and continuous throughout a finite and continuous region bounded by a given surface S . Let volume integration be conducted throughout the volume so bounded, and surface integration over its surface. Let $\nabla^2 V$ be an abbreviation for

$$\frac{\partial}{\partial x} \left(\alpha^2 \frac{\partial V}{\partial x} \right) + \frac{\partial}{\partial y} \left(\alpha^2 \frac{\partial V}{\partial y} \right) + \frac{\partial}{\partial z} \left(\alpha^2 \frac{\partial V}{\partial z} \right).$$

Let dn be an element of the outward drawn normal at any point of the bounding surface S . The theorem to be established is

$$\begin{aligned} & \iint \alpha^2 \left(\frac{\partial V_1}{\partial x} \frac{\partial V_2}{\partial x} + \frac{\partial V_1}{\partial y} \frac{\partial V_2}{\partial y} + \frac{\partial V_1}{\partial z} \frac{\partial V_2}{\partial z} \right) dx dy dz \\ &= \iint V_1 \alpha^2 \frac{\partial V_2}{\partial n} dS - \iiint V_1 \nabla^2 V_2 dx dy dz \\ &= \iint V_2 \alpha^2 \frac{\partial V_1}{\partial n} dS - \iiint V_2 \nabla^2 V_1 dx dy dz. \end{aligned}$$

Consider the term $\iiint \alpha^2 \frac{\partial V_1}{\partial x} \frac{\partial V_2}{\partial x} dx dy dz$. Integration by parts gives

$$\iint \left[V_2 \alpha^2 \frac{\partial V_1}{\partial x} \right] dy dz - \iiint V_2 \frac{\partial}{\partial x} \left(\alpha^2 \frac{\partial V_1}{\partial x} \right) dx dy dz.$$

Construct an elementary rectangular prism parallel to the x -axis on base $dy dz$ in the y - z plane, and let it intercept upon the surface S elementary areas dS_1, dS_2, dS_3, \dots , at which the direction cosines of the normals are $(\lambda_1, \mu_1, \nu_1), (\lambda_2, \mu_2, \nu_2), \dots$, the suffix 1 relating to the element furthest from the y - z plane and the others being in order of approach to that plane. Then

$$dy dz = +\lambda_1 dS_1 = -\lambda_2 dS_2 = +\lambda_3 dS_3 = \dots$$

Now the limits in the first integral $\left[V_2 \alpha^2 \frac{\partial V_1}{\partial x} \right]$ are those which correspond to the elements in which the elementary prism cuts the surface S , i.e. from the end of any intercepted

* *Math. Papers of the late George Green.* Edited by Dr. Ferrers.

portion of the prism nearest the y - z plane to the end furthest from that plane. Let the values of $V_2\alpha^2\frac{\partial V_1}{\partial x}$ at the several points be denoted by the corresponding suffixes to the square brackets.

$$\begin{aligned} &\text{Then } \iiint \left[V_2\alpha^2 \frac{\partial V_1}{\partial x} \right] dy dz \text{ taken for the whole prism} \\ &= \iiint \left\{ \left[V_2\alpha^2 \frac{\partial V_1}{\partial x} \right]_1 (+\lambda_1 dS_1) - \left[V_2\alpha^2 \frac{\partial V_1}{\partial x} \right]_2 (-\lambda_2 dS_2) \right. \\ &\quad \left. + \left[V_2\alpha^2 \frac{\partial V_1}{\partial x} \right]_3 (+\lambda_3 dS_3) - \dots \right\}, \end{aligned}$$

that is simply, when we integrate for the whole surface, summing the results for all such prisms

$$= \iint V_2\alpha^2 \frac{\partial V_1}{\partial x} \lambda dS.$$

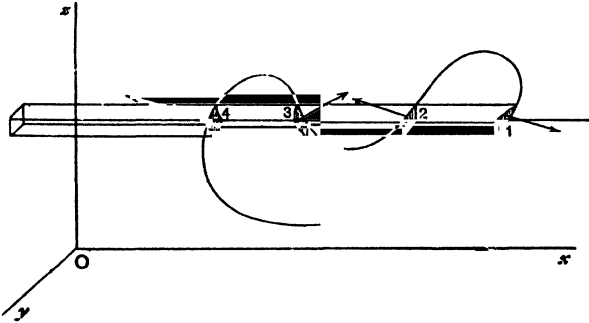

Fig. 591

Treating the remaining terms in the same way, and noting that $\lambda \frac{\partial}{\partial x} + \mu \frac{\partial}{\partial y} + \nu \frac{\partial}{\partial z} \equiv \frac{\partial}{\partial n}$, we have upon addition the theorem stated.

Green's Theorem, for which $\alpha=1$ and $\nabla^2 \equiv \frac{\partial^2}{\partial x^2} + \frac{\partial^2}{\partial y^2} + \frac{\partial^2}{\partial z^2}$, is

$$\begin{aligned} \iiint \left(\frac{\partial V_1}{\partial x} \frac{\partial V_2}{\partial x} + \dots \right) dx dy dz &= \iint V_1 \frac{\partial V_2}{\partial n} dS - \iiint V_1 \nabla^2 V_2 dx dy dz \\ &= \iint V_2 \frac{\partial V_1}{\partial n} dS - \iiint V_2 \nabla^2 V_1 dx dy dz. \end{aligned}$$

1783. Various Deductions.

1. It follows that

$$\iint \left(V_1 \frac{\partial V_2}{\partial n} - V_2 \frac{\partial V_1}{\partial n} \right) dS = \iiint (V_1 \nabla^2 V_2 - V_2 \nabla^2 V_1) dx dy dz.$$

2. If V_1 and V_2 both satisfy Laplace's Equation $\nabla^2 V = 0$, we have

$$\iint V_1 \frac{\partial V_2}{\partial n} dS = \iint V_2 \frac{\partial V_1}{\partial n} dS.$$

3. If $V_2 = \text{constant}$, $\iint \frac{\partial V_1}{\partial n} dS = \iiint \nabla^2 V_1 dx dy dz$. This is known as the Divergence Theorem (see Webster, *Elect. and Mag.*, p. 66).

4. If $V_2 = \text{constant}$ and V_1 be a function of x, y, z , viz. V , satisfying Laplace's Equation, $\iint \frac{\partial V}{\partial n} dS = 0$. It follows that V does not under such circumstances admit of a true maximum or minimum value for all directions of displacement at any point of space for which it remains finite and continuous and satisfies Laplace's Equation. For if at any point such a maximum or minimum could exist, V would be decreasing or increasing in all directions from that point, and therefore $\frac{\partial V}{\partial n}$ would maintain the same sign at all points of a small sphere with that point for centre, and $\iint \frac{\partial V}{\partial n} dS$ could not vanish for that surface. The same thing is obvious also from Laplace's Equation directly; for one condition for a maximum or a minimum is that V_{xx}, V_{yy}, V_{zz} must have the same sign, and therefore their sum could not be zero.

5. If V_p and V_q be two homogeneous algebraic functions of x, y, z of respective degrees p and q , each satisfying Laplace's equation for the region between a pair of spherical surfaces of radii a and b , whose centres are at the origin; then if V_p and V_q be written respectively as $r^p Y_p$ and $r^q Y_q$, so that Y_p and Y_q are functions of angular coordinates only, then

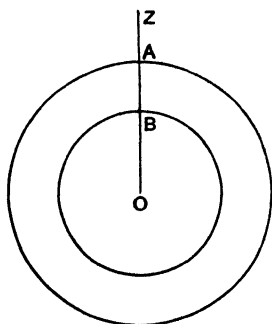

Fig. 592.

will $\int_0^\pi \int_0^{2\pi} Y_p Y_q \sin \theta d\theta d\phi = 0$, provided $p \neq q$ and $p+q \neq -1$.

For $\int V_p \frac{\partial V_q}{\partial n} dS = \int V_q \frac{\partial V_p}{\partial n} dS$, the integration being conducted over the two surfaces.

Writing $dS = a^2 d\omega$ or $b^2 d\omega$ for the respective elements of the outer and the inner surface, $d\omega$ being an elementary solid angle, we get

$$\int (r^p Y_p q r^{q-1} Y_q - r^q Y_q p r^{p-1} Y_p) dS = 0,$$

$$\text{and } (q-p)(a^{p+q+1} - b^{p+q+1}) \int Y_p Y_q d\omega = 0,$$

and therefore, provided $p \neq q$ and $p+q \neq -1$, $\int_0^\pi \int_0^{2\pi} Y_p Y_q \sin \theta d\theta d\phi = 0$,

or writing $\mu \equiv \cos \theta$, $\int_{-1}^1 \int_0^{2\pi} Y_p Y_q d\mu d\phi = 0$; that is $\int V_p V_q dS = 0$, where the integration is taken over the surface of any sphere with centre at the origin.

The theorem is due to Laplace. The proof is Lord Kelvin's [Thomson and Tait, *Nat. Phil.* 1879, p. 180].

Note that in the proof of this general result the taking of an inner surface $r = b$ avoids the continuation of the volume integration over the immediate region of the origin at which such a solution of Laplace's Equation as $V = r^{-1}$ would become infinite, and Green's Theorem on which this result is based would be inapplicable.

6. Many other deductions will be found in works dealing with attractions, electricity and magnetism, etc.

The region bounded by the surface S is regarded as "singly connected," or capable of being made so by suitable diaphragms; so that any of the infinite number of paths from any point A to any second point B within the region are deformable into each other without crossing the boundaries of the surface.*

1784. Unique Character of Solutions of Laplace's Equation.

If a solution of Laplace's Equation has been found which is such as to assume a definite assigned value at each point of a given closed surface S bounding a given region, that solution is unique for all points within the region; and if it is such as to vanish at ∞ it is also unique for all points outside the region.

For, if two functions V_1 and V_2 could each satisfy the stated conditions at points within the surface, their difference W would vanish at all points of the surface. But Green's Theorem gives

$$\iiint \left[\left(\frac{\partial W}{\partial x} \right)^2 + \dots \right] dx dy dz = \iint W \frac{\partial W}{\partial n} dS - \iiint \nabla^2 W dx dy dz = 0.$$

Hence $\frac{\partial W}{\partial x}$, $\frac{\partial W}{\partial y}$, $\frac{\partial W}{\partial z}$ must vanish at every point of the region, and therefore W must be a constant throughout the region, vanishing at the surface, and therefore at all other internal points. Hence V_1 and V_2 must be identical.

Similarly for points outside the surface with the condition as to vanishing at infinity.

Hence solutions of Laplace's Equation are unique and determinate for any finite region when their values are known over its surface supposed closed.

* For the effect of Cyclosis, see Clerk Maxwell, *E. and M.*, I., page 109.

We note also that if $\frac{\partial V}{\partial n}$ were given at each point of the surface, we should equally have $\int W \frac{\partial W}{\partial n} dS \equiv 0$, for $\frac{\partial W}{\partial n} = 0$.

HARMONIC ANALYSIS.

1785. **Def.** Any homogeneous function of x, y, z which satisfies the equation $\nabla^2 V = 0$ is called a **Spherical Solid Harmonic**.

Denoting $x^2 + y^2 + z^2$ by r^2 , we have $\nabla^2 r^m = m(m+1)r^{m-2}$ (*D.C.*, p. 137).

This vanishes when $m=0$, or -1 , (except where $r=0$). Hence a constant is a spherical solid harmonic of degree zero, and r^{-1} is a spherical solid harmonic of degree -1 .

Laplace's equation is unaffected by writing $x-x_0, y-y_0, z-z_0$ for x, y, z respectively.

Hence $\{(x-x_0)^2 + (y-y_0)^2 + (z-z_0)^2\}^{-\frac{1}{2}}$ is also a solution, except at (x_0, y_0, z_0) , where it becomes infinite.

If V_n be any homogeneous function of degree n satisfying $\nabla^2 V = 0$, then V_n/r^{2n+1} is also a solution (*D.C.*, p. 137). Its degree is $-n-1$. Therefore to any spherical solid harmonic of degree n corresponds another, viz. V_n/r^{2n+1} of degree $-n-1$.

1786. Specimens of Spherical Solid Harmonics.

Lord Kelvin (Thomson and Tait, *Nat. Phil.*, pp. 172-176) gives a long list of particular solutions of $\nabla^2 V = 0$. We select a few typical cases, which may readily be verified.

Degree zero, $\log \frac{r+z}{r-z}, \tan^{-1} \frac{y}{x}, \frac{rx}{x^2+y^2}$.

Degree -1 , $\frac{1}{r}, \frac{1}{r} \tan^{-1} \frac{y}{x}, \frac{1}{r} \log \frac{r+z}{r-z}, \frac{x}{x^2+y^2}$.

Degrees 1 and -2 ,

$$Ax + By + Cz, z \tan^{-1} \frac{y}{x}, \frac{x}{r^3}, \frac{y}{r^3}, \frac{z}{r^3}, \frac{z}{r^3} \tan^{-1} \frac{y}{x}, \frac{x^2 - y^2}{(x^2 + y^2)^2}$$

Degrees 2 and -3 , $2z^2 - x^2 - y^2, x^2 - y^2, Ayz + Bzx + Cxy, yz/r^4$.

1787. If V_n be a spherical solid harmonic of degree n , and we write $V_n = r^n Y_n$, as in Art. 1783 (5), Y_n is a function of the direction of the point x, y, z as viewed from the origin, and if we take r as a constant, Y_n is called a "**Spherical Surface Harmonic**" or a "**Laplace's Function**."

1788. Number of Arbitrary Constants in the General Spherical Harmonic of degree n .

The number of coefficients in the general rational integral algebraic expression of degree n in three variables is the number of homogeneous products of degree n in x, y, z , viz.

$$\frac{1}{2}(n+2)(n+1).$$

When operated upon by ∇^2 we have a homogeneous function of degree $n-2$ containing $\frac{1}{2}n(n-1)$ coefficients, each of which is to vanish, which furnishes this number of relations amongst the original coefficients. Hence the number of independent arbitrary constants in V_n or Y_n is

$$\frac{1}{2}(n+2)(n+1) - \frac{1}{2}n(n-1) = 2n+1.$$

Such a series as $\frac{1}{r} Y_0 + \frac{a}{r^2} Y_1 + \frac{a^2}{r^3} Y_2 + \dots + \frac{a^n}{r^{n+1}} Y_n$, where a is given, will therefore contain $1+3+5+\dots+(2n+1)$, i.e. $(n+1)^2$, arbitrary constants, and in the case where $Y_0=0$, as for the potential of a magnetic body, the number is less than this by unity, viz. $n(n+2)$.

1789. Construction of New Harmonics.

Since $\nabla^2 V=0$ is a linear differential equation, when any solution V_i has been found, it is obvious that $\frac{\partial^{a+b+c}}{\partial x^a \partial y^b \partial z^c} V_i$ is another solution. So that if V_i be a spherical solid harmonic of degree i , we have another of degree $i-a-b-c$.

Moreover $(l \frac{\partial}{\partial x} + m \frac{\partial}{\partial y} + n \frac{\partial}{\partial z}) V_i$ will also be a solution; or further still, if $(l_1, m_1, n_1), (l_2, m_2, n_2), \dots$ be any number of sets of direction cosines of arbitrary linear elements dh_1, dh_2, \dots so that $\frac{\partial}{\partial h_1} \equiv l_1 \frac{\partial}{\partial x} + m_1 \frac{\partial}{\partial y} + n_1 \frac{\partial}{\partial z}$, etc., then $\frac{\partial}{\partial h_1} \frac{\partial}{\partial h_2} \frac{\partial}{\partial h_3} \dots \frac{\partial}{\partial h_j} V$ is also a solution of Laplace's Equation, and is a spherical solid harmonic of degree $i-j$.

1790. Poles and Axes. Clerk Maxwell (*E. and M.*, p. 162)

Consider a spherical surface of centre O and radius r , referred to three rectangular axes Ox, Oy, Oz . Let A_1, A_2, A_3, \dots be fixed points on the surface, and P any other point upon the surface. Let the direction cosines of OA_1, OA_2, \dots be

$(l_1, m_1, n_1), (l_2, m_2, n_2), \dots$ and x, y, z the coordinates of P . Let $\lambda_i \equiv \cos A_i \hat{O}P, \mu_{ij} \equiv \cos A_i \hat{O}A_j$. Let dh_1, dh_2, \dots be linear elements in the directions OA_1, OA_2, \dots . Then the lines OA_1, OA_2, \dots are called "axes"; A_1, A_2, \dots are called "poles"; and the operation $\frac{\partial}{\partial h_i} = l_i \frac{\partial}{\partial x} + m_i \frac{\partial}{\partial y} + n_i \frac{\partial}{\partial z}$ is called differentiation "with regard to the axis OA_i ."

Let p_i be a perpendicular from O upon a plane through P perpendicular to OA_i ; then $p_i = lx + m_i y + n_i z = r \lambda_i$, and we have

$$\frac{\partial r}{\partial h_i} = l_i \frac{\partial r}{\partial x} + m_i \frac{\partial r}{\partial y} + n_i \frac{\partial r}{\partial z} = l_i \frac{x}{r} + m_i \frac{y}{r} + n_i \frac{z}{r} = \frac{p_i}{r} = \lambda_i,$$

$$\frac{\partial p_i}{\partial h_i} = \left(l_i \frac{\partial}{\partial x} + \dots \right) (lx + \dots) = l_i l + m_i m_j + n_i n_j = \mu_{ij} = \mu_i = \frac{\partial p_i}{\partial h_i},$$

$$\frac{\partial \lambda_j}{\partial h_i} = \frac{\partial}{\partial h_i} \left(\frac{p_j}{r} \right) = \frac{1}{r} \cdot \mu_{ij} - \frac{p_j}{r^2} \lambda_i = \frac{\mu_{ij} - \lambda_i \lambda_j}{r} = \frac{\partial \lambda_j}{\partial h_i}.$$

1791. Consider the effect of the operations

$$-\frac{\partial}{\partial h_1}, \quad (-1)^2 \frac{\partial}{\partial h_2} \frac{\partial}{\partial h_1}, \quad (-1)^3 \frac{\partial}{\partial h_3} \frac{\partial}{\partial h_2} \frac{\partial}{\partial h_1},$$

performed successively upon the function $\frac{1}{r}$. Let us write $\Sigma \lambda^{i-2s} \mu^s$ for the sum of all possible products consisting of $i-2s$ λ 's with different suffixes and s μ 's with double suffixes, each suffix 1, 2, 3, ... i occurring once and once only in each product.

Also let us write V_{-i-1} for $(-1)^i \frac{\partial}{\partial h_i} \frac{\partial}{\partial h_{i-1}} \dots \frac{\partial}{\partial h_1} \cdot \frac{1}{r}$, and also

$V_{-i-1} = \frac{i!}{r^{i+1}} Y_i = \frac{U_i}{r^{2i+1}}$. Then V_{-i-1}, U_i are spherical solid harmonics of respective degrees $-(i+1)$ and i . We then have

$$\frac{U_0}{r} = V_{-1} = \frac{1}{r},$$

$$\frac{U_1}{r^3} = V_{-2} = -\frac{\partial}{\partial h_1} \frac{1}{r} = \frac{1}{r^2} \frac{\partial r}{\partial h_1} = \frac{\lambda_1}{r^2},$$

$$\frac{U_2}{r^5} = V_{-3} = (-1)^2 \frac{\partial}{\partial h_2} \frac{\partial}{\partial h_1} \frac{1}{r} = 2 \frac{\lambda_1}{r^3} \lambda_2 - \frac{1}{r^2} \mu_{12} - \frac{\lambda_1 \lambda_2}{r} = \frac{1}{r^3} (3 \lambda_1 \lambda_2 - \mu_{12}),$$

$$\frac{U_3}{r^7} = V_{-4} = (-1)^3 \frac{\partial}{\partial h_3} \frac{\partial}{\partial h_2} \frac{\partial}{\partial h_1} \frac{1}{r} = \text{etc.} = \frac{1 \cdot 3 \cdot 5}{r^4} (\lambda_1 \lambda_2 \lambda_3 - \frac{1}{3} \Sigma \lambda^i \mu^i), \text{ etc.}$$

1792. **The General Form is**

$$\frac{U_i}{r^{2i+1}} = V_{-i-1} = \frac{1.3 \dots (2i-1)}{r^{i+1}} \left\{ \lambda_1 \lambda_2 \dots \lambda_i - \frac{1}{2i-1} \Sigma \lambda^{i-2} \mu \right. \\ \left. + \frac{1}{(2i-1)(2i-3)} \Sigma \lambda^{i-4} \mu^2 - \dots \right\}$$

to $\frac{i-1}{2}$ or $\frac{i}{2}$ terms, according as i is odd or even,

$$i.e. Y_i = \frac{1.3 \dots (2i-1)}{i!} \left\{ \lambda_1 \lambda_2 \dots \lambda_i - \frac{1}{2i-1} \Sigma \lambda^{i-2} \mu \right. \\ \left. + \frac{1}{(2i-1)(2i-3)} \Sigma \lambda^{i-4} \mu^2 - \dots \right\}.$$

1793. This form may be established by induction (Clerk Maxwell, *E. and M.*, I., p. 161). To do so it is desirable to substitute for each λ the corresponding p/r . For differentiation of r and the p 's is simpler than that of the λ 's in performing the operation $-\frac{\partial}{\partial h_{i+1}}$.

1794. When all the axes coincide the λ 's are all equal, and the μ 's are each unity.

If we write $V_{-i-1} \equiv i! \frac{Y_i}{r^{i+1}}$ when the axes are different, and $i! \frac{Z_i}{r^{i+1}}$ when they are coincident, we have

$$Y_i = \frac{1.3 \dots (2i-1)}{i!} \left\{ \lambda_1 \lambda_2 \dots \lambda_i - \frac{1}{2i-1} \Sigma \lambda^{i-2} \mu + \frac{1}{(2i-1)(2i-3)} \Sigma \lambda^{i-4} \mu^2 - \dots \right\}, \\ Z_i = \frac{1.3 \dots (2i-1)}{i!} \left\{ \lambda^i - \frac{i(i-1)}{2(2i-1)} \lambda^{i-2} + \frac{i(i-1)(i-2)(i-3)}{2.4(2i-1)(2i-3)} \lambda^{i-4} - \dots \right\}.$$

1795. In the latter case, when the i axes coincide, Z_i is a function of one variable only, viz. the angle which the vector to x, y, z makes with the fixed axis. When this angle is fixed, the value of Z_i is fixed, and the equation $Z_i = \text{const.}$ gives a family of circles on the surface of the sphere, the planes of these circles being at right angles to the axis of the harmonic. The harmonic is now called a "zonal harmonic."

1796. In the former case Y_i is a function of the i cosines $\lambda_1, \lambda_2, \dots, \lambda_i$ which are variables, and of the $\frac{i(i-1)}{2}$ cosines $\mu_{12}, \mu_{13}, \mu_{23}, \dots$ which are constants. As there are in this

case i arbitrary axes, and each requires three direction cosines l, m, n to fix it, between which there is an identical relation $l^2 + m^2 + n^2 = 1$, Y_i will involve $2i$ arbitrary constants. Also since the expression for Y_i may be multiplied by any arbitrary constant M , and the function $V_i \equiv i! M Y_i r^i$ still satisfies Laplace's Equation, this value of V_i contains $2i + 1$ arbitrary constants inclusive of M , and is the most general form of a spherical harmonic of degree i (see Art. 1788).

1797. The Zonal Surface Harmonic Z_i will contain three arbitrary constants, viz. two which fix the direction of its axis, and M . After the fixation of the axis, say to coincide with the z -axis, the only constant left is M , and if we choose $M = 1$, Z_i becomes a definite numerical quantity.

If the axis OA of this zonal harmonic Z_i be in the direction (θ_0, ϕ_0) , i.e. given by its co-latitude and azimuthal angle, and if OP be drawn in the direction (θ, ϕ) , then

$$\lambda = \cos \theta \cos \theta_0 + \sin \theta \sin \theta_0 \cos (\phi - \phi_0).$$

If the axis be the z -axis, then $\theta_0 = 0$ and $\lambda = \cos \theta$.

In the former case there are two independent variables θ, ϕ , and the Zonal Spherical Surface Harmonic is known as a **Laplace's Coefficient**.

In the latter case there is but one independent variable, viz. θ , and the pole of the harmonic is the pole of the sphere which is the positive extremity of the z -axis.

1798. LEGENDRE'S COEFFICIENTS.

If we expand the function $(1 - 2ph + h^2)^{-\frac{1}{2}}$ in powers of h , taken as < 1 , as

$$(1 - 2ph + h^2)^{-\frac{1}{2}} = P_0 + P_1 h + P_2 h^2 + \dots + P_n h^n + \dots,$$

irrespective of what p may stand for, then P_n or $P_n(p)$ is called **Legendre's Coefficient** of order n .

If $(r, \theta, \phi), (r_0, \theta_0, \phi_0)$ be the coordinates of points P, A and λ the cosine of the angle AOP , O being the origin, the inverse of the distance AP is $(r^2 - 2rr_0\lambda + r_0^2)^{-\frac{1}{2}}$, and may be written as $\frac{1}{r_0} \left(1 - 2\lambda \frac{r}{r_0} + \frac{r^2}{r_0^2}\right)^{-\frac{1}{2}}$ or $\frac{1}{r} \left(1 - 2\lambda \frac{r_0}{r} + \frac{r_0^2}{r^2}\right)^{-\frac{1}{2}}$, according as r_0 is $>$ or $<$ r . Accordingly, we have

$$\frac{1}{AP} = \begin{cases} \frac{1}{r_0} \left(Q_0 + Q_1 \frac{r}{r_0} + Q_2 \frac{r^2}{r_0^2} + \dots + Q_n \frac{r^n}{r_0^n} + \dots \right) & \text{for } r < r_0, \\ \frac{1}{r} \left(Q_0 + Q_1 \frac{r_0}{r} + Q_2 \frac{r_0^2}{r^2} + \dots + Q_n \frac{r_0^n}{r^n} + \dots \right) & \text{for } r > r_0, \end{cases}$$

where the Q 's are Legendre's Coefficients for the case when p is < 1 and is a certain cosine. And for all values of r_0/r one or other of these expansions holds good.

Also $\frac{1}{AP}$ being an inverse distance is a Spherical Harmonic, and that series of the two above which is convergent is a spherical harmonic, and satisfies Laplace's Equation; and as it does so for all consistent values of r_0 , each term will do so; so that one or other of the sets

$$(Q_0, Q_1 r, Q_2 r^2, \dots), \left(\frac{Q_0}{r}, \frac{Q_1}{r^2}, \frac{Q_2}{r^3}, \frac{Q_3}{r^4}, \dots \right)$$

forms a series of spherical solid harmonics. Moreover, by Art. 1785, if one set be spherical harmonics, so also are the other set. Therefore they are all spherical harmonics; and Q_n is a spherical surface harmonic of the zonal species.

It follows therefore that a Legendre's Coefficient for which p is a cosine is a Zonal Surface Harmonic. We shall see later that it satisfies Laplace's Equation whatever p may be.

1799. The function

$$R^{-1} \equiv \{x^2 + y^2 + (z - c)^2\}^{-\frac{1}{2}}$$

satisfies Laplace's Equation.

Let $x^2 + y^2 + z^2 = r^2$, and write $(x^2 + y^2 + z^2)^{-\frac{1}{2}}$ as $f(z)$.

Then

$$R^{-1} = f(z - c) = f(z) - c \frac{\partial f}{\partial z} + \frac{c^2}{2!} \frac{\partial^2 f}{\partial z^2} - \dots + \frac{(-1)^n}{n!} c^n \frac{\partial^n f}{\partial z^n} + \dots$$

Again, writing $z = \lambda r$, $R^{-1} = (r^2 - 2\lambda cr + c^2)^{-\frac{1}{2}}$ and taking $r > c$,

$$R^{-1} = \frac{1}{r} \left(Q_0 + Q_1 \frac{c}{r} + Q_2 \frac{c^2}{r^2} + \dots + Q_n \frac{c^n}{r^n} + \dots \right).$$

Hence
$$\frac{Q_n}{r^{n+1}} = \frac{(-1)^n}{n!} \frac{\partial^n f}{\partial z^n} = \frac{(-1)^n}{n!} \frac{\partial^n}{\partial z^n} \frac{1}{r}.$$

The harmonic Q_n is therefore identified with one of those obtained in Arts. 1791 to 1794.

1800. **Preliminary Remarks on Legendre's Coefficient** $P_n(p)$.

The definition being

$$(1-2ph+h^2)^{-\frac{1}{2}}=P_0+P_1h+P_2h^2+\dots+P_nh^n+\dots \quad (h < 1),$$

it follows that, whatever p may be,

$$P_0(p)=1,$$

$$P_n(1)=\text{coef. } h^n \text{ in } (1-h)^{-1}=1,$$

$$P_n(-1)=\text{coef. } h^n \text{ in } (1+h)^{-1}=(-1)^n,$$

$$P_n(0)=\text{coef. } h^n \text{ in } (1+h^2)^{-\frac{1}{2}}=0 \text{ or } (-1)^{\frac{n}{2}} \frac{1 \cdot 3 \dots (n-1)}{2 \cdot 4 \dots n},$$

according as n is odd or even.

If the signs of both p and h be changed, $(1-2ph+h^2)^{-\frac{1}{2}}$ is unaltered. Therefore

$$P_0(p)+P_1(p)h+\dots+P_n(p)h^n+\dots=P_0(-p)-P_1(-p)h+\dots \\ +(-1)^nP_n(-p)h^n+\dots$$

Hence

$$P_0(-p)=P_0(p); P_1(-p)=-P_1(p), \text{ etc., } P_n(-p)=(-1)^nP_n(p).$$

1801. **Power Series for Legendre's Coefficient** $P_n(p)$.

To obtain an expression for P_n as a power series in terms of p , we proceed directly by Expansion of $(1-2ph+h^2)^{-\frac{1}{2}}$, viz.

$$=1+\frac{1}{2}h(2p-h)+\dots+\frac{1 \cdot 3 \dots (2n-3)}{2 \cdot 4 \dots (2n-2)}h^{n-1}(2p-h)^{n-1} \\ +\frac{1 \cdot 3 \dots (2n-1)}{2 \cdot 4 \dots (2n)}h^n(2p-h)^n+\dots$$

Picking out the coefficient of h^n , we have

$$P_n=\frac{1 \cdot 3 \dots (2n-1)}{n!} \left\{ p^n - \frac{n(n-1)}{2(2n-1)} p^{n-2} \right. \\ \left. + \frac{n(n-1)(n-2)(n-3)}{2 \cdot 4(2n-1)(2n-3)} p^{n-4} - \dots \right\}, \dots (A)$$

which is in agreement with the second series of Art. 1794.

$P_n(p)$ is therefore a rational integral algebraic function of p of degree n . The highest index is n . P_n is an odd or an even function of p , according as n is odd or even; and $P_n(-p)=(-1)^nP_n(p)$, as already seen.

1802. **Rodrigues' Form.**

Applying Lagrange's Theorem [*D.C.*, p. 454],

$$(1 - 2ph + h^2)^{-\frac{1}{2}} = 1 + \frac{h}{1!} \frac{1}{2} \frac{d}{dp} (p^2 - 1) + \frac{h^2}{2!} \frac{1}{2^2} \frac{d^2}{dp^2} (p^2 - 1)^2 + \dots + \frac{h^n}{n!} \frac{1}{2^n} \frac{d^n}{dp^n} (p^2 - 1)^n + \dots$$

Hence

$$P_n(p) = \frac{1}{2^n \cdot n!} \frac{d^n}{dp^n} (p^2 - 1)^n, \text{ a form due to Rodrigues.(B)}$$

1803. Rodrigues' form satisfies the differential equation

$$\frac{d}{dp} \left[(1 - p^2) \frac{dP_n}{dp} \right] + n(n + 1)P_n = 0.$$

For writing $z = (p^2 - 1)^n$, and denoting by suffixes of z differentiations with regard to p , we have $z_1(p^2 - 1) = 2npz$; and differentiating this $n + 1$ times by Leibnitz' Theorem,

$$z_{n+2}(p^2 - 1) + 2pz_{n+1} = n(n + 1)z_n,$$

$$\text{i.e. } \frac{d}{dp} [(p^2 - 1)z_{n+1}] = n(n + 1)z_n,$$

$$\text{i.e. } \frac{d}{dp} \left[(1 - p^2) \frac{dP_n}{dp} \right] + n(n + 1)P_n = 0.$$

1804. **Expansion in Terms of Tangents of Half Angles.**

Using Rodrigues' form and putting $p + 1 \equiv u$, $p - 1 \equiv v$,

$$P_n = \frac{1}{2^n n!} \frac{d^n}{dp^n} (u^n v^n) = \frac{1}{2^n} \{ u^n + {}^n C_1^2 u^{n-1} v + {}^n C_2^2 u^{n-2} v^2 + \dots + v^n \}; \dots(C)$$

and putting $p = \cos \theta$, $u = 2 \cos^2 \frac{\theta}{2}$, $v = -2 \sin^2 \frac{\theta}{2}$, we have

$$P_n = \cos^{2n} \frac{\theta}{2} \left\{ 1 - {}^n C_1^2 \tan^2 \frac{\theta}{2} + {}^n C_2^2 \tan^4 \frac{\theta}{2} - {}^n C_3^2 \tan^6 \frac{\theta}{2} + \dots \right\}; \dots(D)$$

1805. **Expansion in a Series of Powers of $\tan \theta$.**

Regarding $(p^2 - 1)^n$ as a function of p^2 and applying the rule of *Diff. Calc.*, Art. 106,

$$P_n = p^n + \frac{1}{2^2} {}^n C_2^2 C_1^2 p^{n-2} (p^2 - 1) + \frac{1}{2^4} {}^n C_4^2 C_2^2 p^{n-4} (p^2 - 1)^2 + \dots; \dots(E)$$

and writing $p = \cos \theta$, we have a form homogeneous in $\cos \theta$ and $\sin \theta$,

$$P_n = \cos^n \theta - \frac{n(n-1)}{2^2} \cos^{n-2} \theta \sin^2 \theta + \frac{n(n-1)(n-2)(n-3)}{2^4 \cdot 4^2} \cos^{n-4} \theta \sin^4 \theta - \dots, \dots(F)$$

$$\text{i.e. } P_n = \cos^n \theta \left[1 - \frac{n(n-1)}{2^2} \tan^2 \theta + \frac{n(n-1)(n-2)(n-3)}{2^4 \cdot 4^2} \tan^4 \theta - \dots \right]. \dots(G)$$

1806. These forms may also be derived by writing

$$(1 - 2ph + h^2)^{-\frac{1}{2}} = \{(1 - ph)^2 + h^2(1 - p^2)\}^{-\frac{1}{2}},$$

expanding and picking out the coefficient of h^n .

[Todhunter, *F. of Laplace*, p. 12.]

1807. **Expansion in Powers of $\cos \frac{\theta}{2}$.**

$$\begin{aligned} \text{Since } (p^2 - 1)^n &= (\overline{p+1} - 2)^n (p+1)^n \\ &= (-1)^n [2^n (p+1)^n - {}^nC_1 2^{n-1} (p+1)^{n+1} + {}^nC_2 2^{n-2} (p+1)^{n+2} - \dots, \end{aligned}$$

we have by Rodrigues' form, and putting $p = \cos \theta$,

$$P_n = (-1)^n \left[1 - {}^{n+1}C_1 {}^nC_1 \cos^2 \frac{\theta}{2} + {}^{n+2}C_2 {}^nC_2 \cos^4 \frac{\theta}{2} - {}^{n+3}C_3 {}^nC_3 \cos^6 \frac{\theta}{2} + \dots \right]. \quad (\text{H})$$

1808. **Expansion in Terms of Cosines of Multiples of θ .**

Taking $2p = t + \frac{1}{t} = 2 \cos \theta$, we have, writing

$$\begin{aligned} (1-z)^{-\frac{1}{2}} &\text{ as } A_0 + A_1 z + A_2 z^2 + \dots, \\ V &= (1 - 2ph + h^2)^{-\frac{1}{2}} = (1 - ht)^{-\frac{1}{2}} (1 - ht^{-1})^{-\frac{1}{2}} \\ &= (A_0 + A_1 ht + \dots + A_n h^n t^n + \dots) (A_0 + A_1 ht^{-1} + \dots + A_n h^n t^{-n} + \dots), \end{aligned}$$

and the coefficient of h^n is obviously

$$\begin{aligned} A_0 A_n (t^n + t^{-n}) + A_1 A_{n-1} (t^{n-1} + t^{-n+1}) + \dots \\ = 2 \left[A_0 A_n \cos n\theta + A_1 A_{n-1} \cos (n-2)\theta + \dots + A_{\frac{n-1}{2}} \cdot A_{\frac{n+1}{2}} \cos \theta \text{ or } \frac{1}{2} A_n^2 \right], \end{aligned}$$

as n is odd or even ;

$$\begin{aligned} \therefore P_n &= 2 \left\{ \frac{1 \cdot 3 \dots (2n-1)}{2 \cdot 4 \dots 2n} \cos n\theta + \frac{1}{2} \cdot \frac{1 \cdot 3 \dots (2n-3)}{2 \cdot 4 \dots (2n-2)} \cos (n-2)\theta \right. \\ &\quad \left. + \frac{1 \cdot 3}{2 \cdot 4} \cdot \frac{1 \cdot 3 \dots (2n-5)}{2 \cdot 4 \dots (2n-4)} \cos (n-4)\theta + \dots \right\}. \quad \dots \dots (\text{I}) \end{aligned}$$

1809. **Limiting Values of the P 's.**

The binomial coefficients in the above form of P_n are all positive, and therefore P_n cannot exceed in numerical value that for which each of the cosines is replaced by unity. And in this case the expression for $P_n = 2(A_0 A_n + A_1 A_{n-1} + \dots) = \text{coef. of } \rho^n \text{ in } (1-\rho)^{-\frac{1}{2}} (1-\rho)^{-\frac{1}{2}}$, i.e. in $(1-\rho)^{-1}$, i.e. 1, i.e. the value of each of the P 's cannot lie outside the limits $+1$ and -1 .

The convergency of the series $1 + P_1 h + P_2 h^2 + \dots$ follows at once by comparison with $1 + h + h^2 + \dots = \frac{1}{1-h}$; $h < 1$.

1810. **Expressions in Terms of Definite Integrals.** [Laplace, *Méc. Céle.*, XI.]

Supposing a positive and $> b$, both being real, we have

$$\int_0^\pi \frac{d\chi}{a + b \cos \chi} = \frac{\pi}{\sqrt{a^2 - b^2}};$$

and writing $a=1-hp$, $b=h\sqrt{p^2-1}$, where p is positive and > 1 , and h negative to ensure a being positive, and both a and b real, we have

$$1-2ph+h^2=a^2-b^2=+ve;$$

$$\therefore \frac{\pi}{\sqrt{1-2ph+h^2}} = \int_0^\pi \frac{d\chi}{1-h(p-\sqrt{p^2-1}\cos\chi)};$$

and expanding each side in powers of h and equating coefficients, $P_n(p) = \frac{1}{\pi} \int_0^\pi (p-\sqrt{p^2-1}\cos\chi)^n d\chi$.

1811. Upon expansion of $(p-\sqrt{p^2-1}\cos\chi)^n$ and integration from 0 to π , all terms arising from odd powers of $\cos\chi$ disappear, and we are left with a rational integral algebraic function of p of degree n , which is identical with $P_n(p)$, (which is known to be a rational integral algebraic function of p of degree n), for all positive values of p greater than unity, *i.e.* for more than n values. Therefore the identity with $P_n(p)$ must hold for all values of p , though it was convenient in the last article to take p positive and > 1 . It will be seen that the expanded form is identical with the expansion (*E*) of Art. 1805.

Also, since the terms with odd powers of $\cos\chi$ contribute nothing, we have also

$$P_n(p) = \frac{1}{\pi} \int_0^\pi (p+\sqrt{p^2-1}\cos\chi)^n d\chi.$$

1812. Writing $p = \cosh a$, we have

$$P_n(\cosh a) = \frac{1}{\pi} \int_0^\pi (\cosh a \mp \sinh a \cos\chi)^n d\chi,$$

and we may transform these further by putting

$$\cos\chi = \frac{\cosh a \cos u \pm \sinh a}{\cosh a \pm \cos u \sinh a}$$

to the forms

$$P_n(\cosh a) = \frac{1}{\pi} \int_0^\pi (\cosh a \pm \sinh a \cos u)^{-n-1} du.$$

1813. Various Forms of Laplace's Equation.

Before proceeding further it is convenient to collect together for reference the more useful forms which Laplace's Equation $\nabla^2 V = 0$ takes when transformed to other systems of coordinates than the Cartesian, and the modifications it undergoes under various circumstances.

By direct transformation to spherical polars (r, θ, ϕ) (*D.C.*, p. 469),

$$\nabla^2 V = \frac{\partial^2 V}{\partial x^2} + \frac{\partial^2 V}{\partial y^2} + \frac{\partial^2 V}{\partial z^2} = 0 \text{ becomes}$$

$$\nabla^2 V = \frac{\partial^2 V}{\partial r^2} + \frac{2}{r} \frac{\partial V}{\partial r} + \frac{1}{r^2} \frac{\partial^2 V}{\partial \theta^2} + \frac{\cot \theta}{r^2} \frac{\partial V}{\partial \theta} + \frac{\operatorname{cosec}^2 \theta}{r^2} \frac{\partial^2 V}{\partial \phi^2} = 0.$$

If $V_n = r^n Y_n$, Y_n being a function of θ and ϕ only, we have

$$\nabla^2 V_n = r^{n-2} \left[\frac{\partial^2 Y_n}{\partial \theta^2} + \cot \theta \frac{\partial Y_n}{\partial \theta} + \operatorname{cosec}^2 \theta \frac{\partial^2 Y_n}{\partial \phi^2} + n(n+1) Y_n \right] = 0,$$

and any solution of this is a **Spherical Surface Harmonic** or **Laplace's Function**. See Art. 1787.

Writing μ for $\cos \theta$, this equation becomes

$$\frac{\partial}{\partial \mu} \left\{ (1-\mu^2) \frac{\partial Y_n}{\partial \mu} \right\} + \frac{1}{1-\mu^2} \frac{\partial^2 Y_n}{\partial \phi^2} + n(n+1) Y_n = 0.$$

Laplace's Coefficients, which are Zonal Harmonics and are cases of Laplace's Functions, satisfy this equation. When ϕ is absent, V_n is a homogeneous function of the n^{th} degree symmetrical about the z -axis; Y_n is a function of θ alone, $= P_n$, and the equation becomes, when p is written for μ ,

$$\frac{d}{dp} \left\{ (1-p^2) \frac{dP_n}{dp} \right\} + n(n+1) P_n = 0.$$

Legendre's Coefficients satisfy this equation, and are the cases of Laplace's Functions for which ϕ is absent, and

$$p = \mu = \cos \theta.$$

Other forms of $\nabla^2 V = 0$ are

$$\frac{\partial}{\partial r} \left(r^2 \sin \theta \frac{\partial V}{\partial r} \right) + \frac{\partial}{\partial \theta} \left(\sin \theta \frac{\partial V}{\partial \theta} \right) + \frac{\partial}{\partial \phi} \left(\frac{1}{\sin \theta} \frac{\partial V}{\partial \phi} \right) = 0,$$

$$r \frac{\partial^2}{\partial r^2} (Vr) + \frac{\partial}{\partial \mu} \left\{ (1-\mu^2) \frac{\partial V}{\partial \mu} \right\} + \frac{1}{1-\mu^2} \frac{\partial^2 V}{\partial \phi^2} = 0.$$

1814. Method of Obtaining these Equations from Hydrodynamical Considerations.

The readiest way to reproduce any particular form of the differential equation is not by direct transformation, but by formation of the appropriate hydrodynamic "Equation of Continuity," expressing the physical fact that in the case of any fluid motion, no creation of matter is going on in any element, any increase or decrease of mass in that element being due to what enters the element from outside or which leaves it.

For a homogeneous fluid in motion with velocity potential V , this condition may be written in the notation of Art. 789 as

$$\Sigma \frac{\partial}{\partial \rho_1} \left(\frac{h_1}{h_2 h_3} \frac{\partial V}{\partial \rho_1} \right) = 0,$$

and by expressing this for Cartesians, for Cylindricals, for Spherical-polars, etc., the several forms cited are at once obtained.

1815. Reverting to the power series,

$$(1 - 2h \cos \gamma + h^2)^{-\frac{1}{2}} = R_0 + R_1 h + R_2 h^2 + \dots + R_n h^n + \dots \quad (h < 1),$$

which defines a case of Legendre's Coefficients in which

$$\cos \gamma = \cos \theta \cos \theta_0 + \sin \theta \sin \theta_0 \cos (\phi - \phi_0) \quad (\text{Art. 1797});$$

it appears that R_n being a zonal harmonic, and a function of θ and ϕ , is a solution of the equation

$$\frac{\partial^2 R_n}{\partial \theta^2} + \cot \theta \frac{\partial R_n}{\partial \theta} + \operatorname{cosec}^2 \theta \frac{\partial^2 R_n}{\partial \phi^2} + n(n+1)R_n = 0,$$

or, what is the same thing, if we write μ, μ_0 for $\cos \theta$ and $\cos \theta_0$, so that $\cos \gamma = \mu \mu_0 + \sqrt{1 - \mu^2} \sqrt{1 - \mu_0^2} \cos (\phi - \phi_0)$,

$$\frac{\partial}{\partial \mu} \left\{ (1 - \mu^2) \frac{\partial R_n}{\partial \mu} \right\} + \frac{1}{1 - \mu^2} \frac{\partial^2 R_n}{\partial \phi^2} + n(n+1)R_n = 0.$$

1816. **The General Solution in the Case when ϕ is absent.**

If the z -axis be taken coincident with the axis of the harmonic, $\mu_0 = 1$, $\cos \gamma = \mu = \cos \theta = p$, and the Laplacian equation reduces to

$$\frac{d}{dp} \left\{ (1 - p^2) \frac{dR_n}{dp} \right\} + n(n+1)R_n = 0. \quad \dots \dots \dots (1)$$

It will be noted that we usually use p instead of μ in this case.

The zonal harmonic P_n is a solution of this equation. To obtain the general solution put $R_n = P_n u$, and we obtain

$$u \left[(1 - p^2) \frac{d^2 P_n}{dp^2} - 2p \frac{dP_n}{dp} + n(n+1)P_n \right] \\ + \left[(1 - p^2) P_n \frac{d^2 u}{dp^2} - 2p P_n \frac{du}{dp} + 2(1 - p^2) \frac{dP_n}{dp} \frac{du}{dp} \right] = 0,$$

in which the first bracket disappears. We therefore get

$$\frac{d^2 u}{dp^2} / \frac{du}{dp} = \frac{2p}{1 - p^2} - \frac{2}{P_n} \frac{dP_n}{dp}, \quad \text{i.e.} \quad \frac{du}{dp} = \frac{B}{P_n^2 (1 - p^2)},$$

B being a constant.

The general solution of equation (1) is therefore of the form $R_n = AP_n + BQ_n$, where $Q_n = P_n \int \frac{dp}{P_n^2(1-p^2)}$, which is called a Legendre's Function "of the second kind."

If, then, we limit our solutions of equation (1) to such functions of p as give R_n a rational integral algebraic form, we take the arbitrary constant B to be zero, and therefore the most general solution of (1) of this form is $R_n = AP_n$.

1817. Since P_n is a particular form of the Spherical Surface Harmonic for which we have obtained the general result $\int_0^\pi \int_0^{2\pi} Y_m Y_n d\mu d\phi = 0$ when taken over the surface of the sphere, we have

$$\int_{-1}^1 \int_0^{2\pi} P_m P_n dp d\phi = 0, \quad \text{and} \quad \therefore \int_{-1}^1 P_m P_n dp = 0, \quad (m \neq n).$$

1818. Particular Cases of P_n expressed in Terms of p , and Positive Integral Powers of p in Terms of P 's.

The general result being

$$P_n = \frac{1 \cdot 3 \dots (2n-1)}{1 \cdot 2 \dots n} \left\{ p^n - \frac{n(n-1)}{2(2n-1)} p^{n-2} + \frac{n(n-1)(n-2)(n-3)}{2 \cdot 4(2n-1)(2n-3)} p^{n-4} - \dots \right.$$

we have the particular cases

$$P_0 = 1; \quad P_1 = p; \quad P_2 = \frac{3}{2}p^2 - \frac{1}{2}; \quad P_3 = \frac{5}{2}p^3 - \frac{3}{2}p;$$

$$P_4 = \frac{5 \cdot 7}{2 \cdot 4} p^4 - 2 \frac{3 \cdot 5}{2 \cdot 4} p^2 + \frac{1 \cdot 3}{2 \cdot 4}; \quad P_5 = \frac{7 \cdot 9}{2 \cdot 4} p^5 - 2 \frac{5 \cdot 7}{2 \cdot 4} p^3 + \frac{3 \cdot 5}{2 \cdot 4} p; \quad \text{etc.}$$

Reversing these results, we have

$$1 = P_0; \quad p = P_1; \quad p^2 = \frac{2}{3}P_2 + \frac{1}{3}P_0; \quad p^3 = \frac{2}{5}P_3 + \frac{3}{5}P_1;$$

$$p^4 = \frac{8}{35}P_4 + \frac{4}{7}P_2 + \frac{1}{7}P_0; \quad \text{etc.}$$

1819. The general character of these latter results will be obvious, viz. p^n will consist of a series of Legendre's coefficients beginning with P_n , falling in order two at a time, with certain numerical coefficients; i.e. its form is

$$p^n = A_n P_n + A_{n-2} P_{n-2} + A_{n-4} P_{n-4} + \dots,$$

and we shall consider in due course the law of formation of the successive A 's.

We note at once that, since each of the P 's becomes unity when $p=1$, we have $A_n + A_{n-2} + A_{n-4} + \dots = 1$.

Again, if $m < n$,

$$\int_{-1}^1 p^m P_n dp = \int_{-1}^1 (A_m P_m + A_{m-2} P_{m-2} + \dots) P_n dp = 0.$$

1820. If $f(p)$ be any rational integral algebraical function of p of lower dimensions than n , then, in the same way,

$$\int_{-1}^1 f(p) P_n dp = 0.$$

1821. The same result may be deduced from Rodrigues' form of P_n .

$$\begin{aligned} \text{For } \int_{-1}^1 f(p) P_n dp &= \frac{1}{2^n n!} \int_{-1}^1 f(p) \frac{d^n}{dp^n} (p^2 - 1)^n dp \\ &= \frac{1}{2^n n!} \left[f(p) \frac{d^{n-1}}{dp^{n-1}} (p^2 - 1)^n - f'(p) \frac{d^{n-2}}{dp^{n-2}} (p^2 - 1)^n + \dots \right. \\ &\quad \left. + (-1)^{n-1} f^{(n-1)}(p) \cdot (p^2 - 1)^n \right]_{-1}^1 = 0, \end{aligned}$$

for after the differentiations are performed $(p^2 - 1)$ is a factor of the whole.

It follows that $\int f(p) P_n dS = 0$ when the integration is taken over the surface of the unit sphere.

1822. The theorem $\int_{-1}^1 p^m P_n dp = 0$, ($m < n$), may be used to obtain the several functions P_1, P_2, P_3, \dots without using the general formula.

Ex. 1. To find P_3 , assume $P_3 = Ap^3 + Bp$. Then $A + B = 1$.

Multiply by p and integrate; then $\frac{2A}{5} + \frac{2B}{3} = \int_{-1}^1 p P_3 dp = 0$.

Hence
$$\frac{A}{5} = \frac{B}{-3} = \frac{1}{2} \quad \text{and} \quad P_3 = \frac{5p^3 - 3p}{2}.$$

Ex. 2. To find P_4 . Assume $P_4 = Ap^4 + Bp^2 + C$. Then $A + B + C = 1$.

Multiply by 1 and by p^2 and integrate.

Then
$$\frac{A}{5} + \frac{B}{3} + \frac{C}{1} = 0 \quad \text{and} \quad \frac{A}{7} + \frac{B}{5} + \frac{C}{3} = 0;$$

$$\therefore \frac{A}{35} = \frac{B}{-30} = \frac{C}{3} = \frac{1}{8}; \quad \text{and} \quad P_4 = \frac{35p^4 - 30p^2 + 3}{8}.$$

Or we might use a determinant to eliminate A, B, C .

These processes, however, speedily grow laborious by virtue of the number of equations to be solved or the order of the determinants to be evaluated. It is therefore desirable to follow another method, as we now show.

1823. Lemma.

If it be desired to solve a system of equations of form

$$\frac{x}{a+\alpha} + \frac{y}{b+\alpha} + \frac{z}{c+\alpha} + \dots = 0, \quad \frac{x}{a+\beta} + \frac{y}{b+\beta} + \frac{z}{c+\beta} + \dots = 0,$$

$$\frac{x}{a+\gamma} + \frac{y}{b+\gamma} + \frac{z}{c+\gamma} + \dots = 0 \dots,$$

one less in number than the number of unknowns, with

$$\frac{x}{a+\lambda} + \frac{y}{b+\lambda} + \frac{z}{c+\lambda} + \dots = \frac{1}{\lambda};$$

and further to calculate such an expression as $\frac{x}{a+\theta} + \frac{y}{b+\theta} + \frac{z}{c+\theta} + \dots$ for the values of x, y, z, \dots found from the above equations without actually calculating x, y, z, \dots themselves, we may proceed as follows. For convenience take the case of three letters x, y, z .

Then $\frac{x}{a+\theta} + \frac{y}{b+\theta} + \frac{z}{c+\theta}$ is to vanish when $\theta = \alpha$ or β and to become $\frac{1}{\lambda}$ when $\theta = \lambda$. Such requirements are obviously satisfied by

$$\frac{x}{a+\theta} + \frac{y}{b+\theta} + \frac{z}{c+\theta} = \frac{1}{\lambda} \frac{(a+\lambda)(b+\lambda)(c+\lambda)}{(a+\theta)(b+\theta)(c+\theta)} \cdot \frac{(\theta-\alpha)(\theta-\beta)}{(\lambda-\alpha)(\lambda-\beta)},$$

which is an obvious identity, for it is a *quadratic* relation in θ , and satisfied by *three* values of θ . The value of x can be found by multiplying by $a+\theta$, and putting $\theta = -\alpha$, viz.

$$x = \frac{1}{\lambda} \frac{(a+\lambda)(b+\lambda)(c+\lambda)}{(b-\alpha)(c-\alpha)} \cdot \frac{(a+\alpha)(a+\beta)}{(\lambda-\alpha)(\lambda-\beta)},$$

and similarly for y and z . When λ is indefinitely large, the last of the given equations takes the form $x+y+z=1$, in which case

$$x = \frac{(a+\alpha)(a+\beta)}{(b-\alpha)(c-\alpha)}, \quad y = \text{etc.}, \quad z = \text{etc.};$$

and generally we have

$$\frac{x}{a+\theta} + \frac{y}{b+\theta} + \frac{z}{c+\theta} + \dots = \frac{(\theta-\alpha)(\theta-\beta)(\theta-\gamma) \dots}{(a+\theta)(b+\theta)(c+\theta)(d+\theta) \dots},$$

there being one more factor in the denominator than in the numerator, no λ occurring.

1824. Ex. 1. Calculate P_5 . Assume $P_5 = Ap^5 + Bp^3 + Cp$.

$$\text{Then} \quad \frac{A}{9} + \frac{B}{7} + \frac{C}{5} = 0, \quad \frac{A}{7} + \frac{B}{5} + \frac{C}{3} = 0, \quad A+B+C=1.$$

Take $\alpha=4, \beta=2, a=5, b=3, c=1$ in the Lemma.

$$\text{Then} \quad A = \frac{(a+\alpha)(a+\beta)}{(b-\alpha)(c-\alpha)} = \frac{9 \cdot 7}{2 \cdot 4}; \quad B = \frac{7 \cdot 5}{(-2) \cdot 2}; \quad C = \frac{5 \cdot 3}{2 \cdot 4};$$

and

$$P_5 = \frac{9 \cdot 7}{2 \cdot 4} p^5 - 2 \cdot \frac{7 \cdot 5}{2 \cdot 4} p^3 + \frac{5 \cdot 3}{2 \cdot 4} p.$$

Ex. 2. Calculate $\int_{-1}^1 p^7 P_8 dp$.

The result is clearly $\frac{2A}{13} + \frac{2B}{11} + \frac{2C}{9}$, but without calculating A , B or C , we have, putting $\theta=8$,

$$2 \frac{(8-4)(8-2)}{13 \cdot 11 \cdot 9} = \frac{2 \cdot 4 \cdot 6}{9 \cdot 11 \cdot 13} = \frac{16}{429}.$$

1825. We have seen that $\int_{-1}^1 p^m P_n dp = 0$, if $m < n$. But if $m \lessdot n$, we can readily calculate the value as in the above example.

But first note that if m and n are one of them odd and the other even, the result is still zero. For writing

$$p^m = A_m P_m + A_{m-2} P_{m-2} + \dots,$$

$$\int_{-1}^1 p^m P_n dp = \int_{-1}^1 (A_m P_m + A_{m-2} P_{m-2} + \dots) P_n dp = 0,$$

as no two suffixes in any of the products of the P 's can be equal.

But if m and n be both even or both odd, and $m \lessdot n$, the result does not vanish. In this case, writing

$$P_n = A p^n + B p^{n-2} + C p^{n-4} + \dots,$$

multiplying by p^k , where $k=n-2, n-4, n-6$, etc., and integrating from -1 to 1 , we have a set of equations of the type $\frac{A}{k+n+1} + \frac{B}{k+n-1} + \frac{C}{k+n-3} + \dots = 0$, one less in number than the coefficients to be found. Also

$$A + B + C + \dots = 1,$$

$$\text{and } \int_{-1}^1 p^m P_n dp = \frac{2A}{m+n+1} + \frac{2B}{m+n-1} + \frac{2C}{m+n-3} + \dots$$

Hence the problem of evaluating this integral ($m \geq n$) is that considered above.

Here $\alpha = n-1, \beta = n-3, \gamma = n-5 \dots,$

$\alpha = n, \quad b = n-2, \quad c = n-4 \dots,$

and $\theta = m+1;$

and

$$\int_{-1}^1 p^m P_n dp = 2 \frac{(\overline{m+1-n-1})(\overline{m+1-n-3}) \dots \text{to } \frac{n-1}{2} \text{ or } \frac{n}{2} \text{ factors}}{(\overline{m+1+n})(\overline{m+1+n-2}) \dots \text{to } \frac{n+1}{2} \text{ or } \frac{n+2}{2} \text{ factors}}$$

$$= 2 \frac{(m-n+2)(m-n+4) \dots m-1 \text{ (or } m)}{(m+n+1)(m+n-1) \dots m+2 \text{ (or } m+1)}.$$

1826. If $m=n$, we have $\int_{-1}^1 p^m P_m dp = 2^{m+1} (m!)^2 / (2m+1)!$.

1827. Again

$$\int_{-1}^1 (P_0 + P_1 h + P_2 h^2 + \dots)^2 dp = \int_{-1}^1 \frac{dp}{1-2ph+h^2} = \frac{1}{h} \log \frac{1+h}{1-h},$$

i.e. $\int_{-1}^1 (P_0^2 + P_1^2 h^2 + P_2^2 h^4 + \dots) dp = 2 \left(1 + \frac{h^2}{3} + \frac{h^4}{5} + \dots \right),$

Hence

$$\int_{-1}^1 P_0^2 dp = 2; \quad \int_{-1}^1 P_1^2 dp = \frac{8}{3}, \quad \text{etc.}, \quad \int_{-1}^1 P_n^2 dp = \frac{2}{2n+1}.$$

Remembering that the area of an elementary belt on the unit sphere may be written as $d\sigma = 2\pi \sin \theta d\theta = -2\pi dp$, we have for the whole sphere

$$\int P_n^2 d\sigma = \frac{4\pi}{2n+1}.$$

1828. Professor J. C. Adams has shown that we may calculate the value of $I_1 = \int_{-1}^1 \frac{P_n}{R} dp$, where $R = \sqrt{1-2ph+h^2}$, by means of Rodrigues' expression for P_n , and thence we may establish the integrals $\int_{-1}^1 P_m P_n dp = 0$ or $\frac{2}{2n+1}$ according as $m \neq n$ or $m = n$.

Integrating by parts, we have at once, writing X for $(p^2-1)^n$ for short,

$$2^n n! I_1 = \int_{-1}^1 \frac{1}{R} \frac{d^n}{dp^n} (p^2-1)^n dp$$

$$= \left[\frac{1}{R} \left(\frac{d^{n-1} X}{dp^{n-1}} \right) \right]_{-1}^1 - \left[\frac{1}{R^2} \left(\frac{d^{n-2} X}{dp^{n-2}} \right) \right]_{-1}^1 + \dots + (-1)^n 1.3.5 \dots (2n-1) h^n \int_{-1}^1$$

$$= (-1)^n 1.3.5 \dots (2n-1) h^n \int_{-1}^1 X \frac{dp}{R^{2n+1}} = (-1)^n 1.3.5 \dots (2n+1) h^n U, \text{ say.}$$

Then $\frac{dU}{dh} = \int_{-1}^1 (p^2-1)^n \frac{p-h}{R^{2n+3}} dp.$

Take a sphere of radius unity, OA the radius, $OH = h < 1$, H lying upon OA . Draw an elementary double cone with vertex H intercepting

superficial elements $d\sigma, d\sigma'$ at P and Q . Let $AHP = \psi, AOP = \theta, QOA = \theta',$
 $HP = R, HQ = R'$. Then $d\sigma/R^2 = d\sigma'/R'^2$; $p = \cos \theta = h + R \cos \psi$;

$$\sin \theta/R = \sin \psi/1, \quad dp = -\sin \theta d\theta, \quad d\sigma = \sin \theta d\theta d\phi,$$

ϕ being the azimuthal angle of the plane AOP ;

$$\therefore \sin \theta d\theta/R^2 = \sin \theta' d\theta'/R'^2, \quad \text{i.e. } dp/R^2 = dp'/R'^2;$$

$$\therefore \frac{dU}{dh} = \int_{-1}^1 \frac{(-\sin^2 \theta)^n}{R^{2n}} \frac{R \cos \psi}{R^2} dp = (-1)^n \int_{-1}^1 \sin^{2n} \psi \cos \psi \frac{dp}{R^2},$$

and for opposite elements at P and Q , $\sin^{2n} \psi$ and $\frac{dp}{R^2}$ have the same values,

but $\cos \psi$ has an opposite sign; hence corresponding elements of the integrand cancel when the integration is effected for the whole sphere,

i.e. $\frac{dU}{dh} = 0$, and therefore U is independent of h .

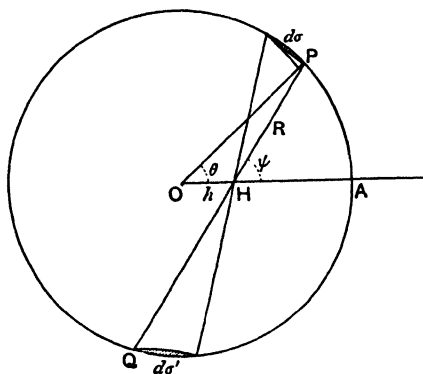

Fig 593.

Hence to evaluate U we may take $h=0$, and therefore $R=1$.

$$\begin{aligned} \text{Then } (-1)^n (2n+1)U &= \int_{-1}^1 (1-p^2)^n dp = \int_{\pi}^0 \sin^{2n} \theta (-\sin \theta d\theta) \\ &= 2 \int_0^{\frac{\pi}{2}} \sin^{2n+1} \theta d\theta = 2^{n+1} n! / 1.3.5 \dots (2n+1); \\ \therefore I_1 &= \frac{2}{2n+1} \cdot h^n. \end{aligned}$$

It follows that $\int_{-1}^1 P_n(P_0 + P_1 h + \dots + P_n h^n + \dots) dp = \frac{2h^n}{2n+1}$; whence $\int_{-1}^1 P_m P_n dp = 0$, ($m \neq n$), and $\int_{-1}^1 P_n^2 dp = \frac{2}{2n+1}$, as seen before.

1829. If $I_m = \int_{-1}^1 \frac{P_n}{R^m} dp$, where $R^2 = 1 - 2ph + h^2$, $\frac{R dR}{dh} = h - p$ and $2h(p-h) = 1 - h^2 - R^2$, and we have

$$\frac{dI_m}{dh} = \int_{-1}^1 \frac{m P_n}{R^{m+1}} \frac{p-h}{R} dp = m \int_{-1}^1 \frac{P_n}{R^{m+2}} \frac{1-h^2-R^2}{2h} dp = m \frac{1-h^2}{2h} I_{m+2} - \frac{m}{2h} I_m.$$

according as p is $+1$ or -1 , and therefore $[P_m P_n]_{-1} = 2$; and further, since $\frac{dP_m}{dp}$ cannot contain a Legendrian function of as high order as P_n the second integral vanishes. Hence in all such cases $\int_{-1}^1 P_m \frac{dP_n}{dp} dp = 2$. Hence

$$2A_{n-1}/(2n-1) = 2A_{n-3}/(2n-5) = 2A_{n-5}/(2n-9) = \dots = 2,$$

and we have

$$\frac{dP_n}{dp} = (2n-1)P_{n-1} + (2n-5)P_{n-3} + (2n-9)P_{n-5} + \dots + 3P_1 \quad (\text{or } P_0)$$

according as n is even or odd.

1835. Similarly we may write

$$\frac{d^2 P_n}{dp^2} = B_{n-2} P_{n-2} + B_{n-4} P_{n-4} + B_{n-6} P_{n-6} + \dots = \Sigma B_r P_r, \text{ say,}$$

and multiplying by P_r for $r = n-2, n-4, n-6, \dots$, and integrating from $p = -1$ to $p = 1$ and using accents for differentiations,

$$\frac{2}{2r+1} B_r = \int_{-1}^1 P_r \frac{d^2 P_n}{dp^2} dp = [P_r P_n' - P_r' P_n]_{-1}^1 + \int_{-1}^1 P_n P_r'' dp,$$

and as $r < n$ the final integral vanishes

Also, since $(1-p^2)P_n'' - 2pP_n' + n(n+1)P_n = 0$, we have, when $p = \pm 1$,

$$P_n' = \frac{n(n+1)}{2} \frac{P_n}{p}, \text{ and therefore } [P_r P_n' - P_r' P_n]_{-1}^1 = \left\{ \frac{n(n+1)}{2} - \frac{r(r+1)}{2} \right\} \left[\frac{P_n P_r}{p} \right]_{-1}^1$$

and n and r being both odd or both even, $\frac{P_n P_r}{p}$ is an odd function of p ,

and therefore $\left[\frac{P_n P_r}{p} \right]_{-1}^1 = 2$. Therefore $B_r = \frac{2r+1}{2} (n-r)(n+r+1)$ and

$$\frac{d^2 P_n}{dp^2} = 1 \cdot (2n-1)(2n-3)P_{n-2} + 2(2n-3)(2n-7)P_{n-4} + 3(2n-5)(2n-11)P_{n-6} + \dots,$$

and in the same way higher order differential coefficients may be expressed.

1836. Obviously

$$\int_{-1}^1 \frac{dP_m}{dp} \cdot \frac{dP_n}{dp} dp = \int_{-1}^1 [(2m-1)P_{m-1} + \dots][(2n-1)P_{n-1} + \dots] dp;$$

and, if $m+n$ be odd, no suffixes can be the same in the two brackets, and the integral vanishes. But if $m+n$ be even, suppose $m > n$. Then the terms which do not vanish are

$$(2m-1)^2 \int_{-1}^1 P_{m-1}^2 dp + (2m-5)^2 \int_{-1}^1 P_{m-3}^2 dp + \dots$$

$$= 2[(2m-1) + (2m-5) + (2m-9) + \dots + 1 \text{ (or } 3)] \text{ as } m \text{ is odd or even;}$$

and there being $\frac{m+1}{2}$ or $\frac{m}{2}$ terms in the two cases, their sum is in either

case $m(m+1)$, i.e. $\int_{-1}^1 \frac{dP_m}{dp} \frac{dP_n}{dp} dp = 0$ or $m(m+1)$ as $m+n$ is odd or even, m being the smaller of the two, m and n .

1837. We might also proceed directly thus ($m \leq n$),

$$\int_{-1}^1 \frac{dP_m}{dp} \frac{dP_n}{dp} dp = [P_n P_m]_{-1}^1 - \int_{-1}^1 P_n P_m'' dp;$$

and since n is greater than the degree of any power of p in P_m'' , the terminal integral vanishes.

Again, $(1-p^2)P_m'' - 2pP_m' + m(m+1)P_m = 0$, and therefore if $p = \pm 1$
 $P_m' = \frac{m(m+1)}{2} \frac{P_m}{p}$.

Now $\frac{P_m P_n}{p}$ is an even or an odd function of p according as $m+n$ is odd or even, and therefore $\left[\frac{P_m P_n}{p}\right]_{-1}^1 = 0$ or 2 as $m+n$ is odd or even; therefore $\int_{-1}^1 \frac{dP_m}{dp} \frac{dP_n}{dp} dp = 0$ or $m(m+1)$ according as $m+n$ is odd or even and $n \neq m$.

1838. **Differential Equation satisfied by Legendre's Functions.**

Starting again from the definition of Legendre's Coefficients, viz. $V = (1-2ph+h^2)^{-\frac{1}{2}} = \sum_0^{\infty} P_n h^n$, it is easy to see that they satisfy a form of Laplace's equation, without reference to the fact that when p is a cosine these coefficients are Zonal Harmonics.

For $V^2(1-2ph+h^2) = 1$ and $2 \log V + \log(1-2ph+h^2) = 0$, whence

$$\frac{\partial V}{\partial p} = hV^3, \quad \frac{\partial V}{\partial h} = (p-h)V^3, \quad \text{and} \quad p \frac{\partial V}{\partial p} - h \frac{\partial V}{\partial h} = h^2 V^3. \dots (1)$$

Again,

$$\left. \begin{aligned} \frac{\partial}{\partial p} \left\{ (1-p^2) \frac{\partial V}{\partial p} \right\} &= -2hpV^3 + 3h^2(1-p^2)V^5, \\ \frac{\partial}{\partial h} \left(h^2 \frac{\partial V}{\partial h} \right) &= (2hp - 3h^2)V^3 + 3h^2(p-h)^2 V^5, \end{aligned} \right\}$$

and adding, $\frac{\partial}{\partial p} \left\{ (1-p^2) \frac{\partial V}{\partial p} \right\} + \frac{\partial}{\partial h} \left(h^2 \frac{\partial V}{\partial h} \right) = 0, \dots \dots \dots (2)$

by virtue of $V^2(1-2ph+h^2) = 1$.

Substituting $V = \sum P_n h^n$, and equating to zero the coefficient of h^n ,

$$\frac{d}{dp} \left\{ (1-p^2) \frac{dP_n}{dp} \right\} + n(n+1)P_n = 0, \dots \dots \dots (3)$$

or $(1-p^2) \frac{d^2 P_n}{dp^2} - 2p \frac{dP_n}{dp} + n(n+1)P_n = 0$ (Art. 1813).(4)

according as p is $+1$ or -1 , and therefore $[P_m P_n]_{-1}^1 = 2$; and further, since $\frac{dP_m}{dp}$ cannot contain a Legendrian function of as high order as P_n the second integral vanishes. Hence in all such cases $\int_{-1}^1 P_m \frac{dP_n}{dp} dp = 2$. Hence

$$2A_{n-1}/(2n-1) = 2A_{n-3}/(2n-5) = 2A_{n-5}/(2n-9) = \dots = 2,$$

and we have

$$\frac{dP_n}{dp} = (2n-1)P_{n-1} + (2n-5)P_{n-3} + (2n-9)P_{n-5} + \dots + 3P_1 \quad (\text{or } P_0)$$

according as n is even or odd.

1835. Similarly we may write

$$\frac{d^2 P_n}{dp^2} = B_{n-2}P_{n-2} + B_{n-4}P_{n-4} + B_{n-6}P_{n-6} + \dots = \Sigma B_r P_r, \text{ say,}$$

and multiplying by P_r for $r = n-2, n-4, n-6, \dots$, and integrating from $p = -1$ to $p = 1$ and using accents for differentiations,

$$\frac{2}{2r+1} B_r = \int_{-1}^1 P_r \frac{d^2 P_n}{dp^2} dp = [P_r P_n' - P_r' P_n]_{-1}^1 + \int_{-1}^1 P_n P_r'' dp,$$

and as $r < n$ the final integral vanishes.

Also, since $(1-p^2)P_n'' - 2pP_n' + n(n+1)P_n = 0$, we have, when $p = \pm 1$,

$$P_n' = \frac{n(n+1)}{2} \frac{P_n}{p}, \text{ and therefore } [P_r P_n' - P_r' P_n]_{-1}^1 = \left\{ \frac{n(n+1)}{2} - \frac{r(r+1)}{2} \right\} \left[\frac{P_n P_r}{p} \right]_{-1}^1;$$

and n and r being both odd or both even, $\frac{P_n P_r}{p}$ is an odd function of p ,

and therefore $\left[\frac{P_n P_r}{p} \right]_{-1}^1 = 2$. Therefore $B_r = \frac{2r+1}{2} (n-r)(n+r+1)$ and

$$\frac{d^2 P_n}{dp^2} = 1 \cdot (2n-1)(2n-3)P_{n-2} + 2(2n-3)(2n-7)P_{n-4} + 3(2n-5)(2n-11)P_{n-6} + \dots,$$

and in the same way higher order differential coefficients may be expressed.

1836. Obviously

$$\int_{-1}^1 \frac{dP_m}{dp} \cdot \frac{dP_n}{dp} dp = \int_{-1}^1 [(2m-1)P_{m-1} + \dots][(2n-1)P_{n-1} + \dots] dp;$$

and, if $m+n$ be odd, no suffixes can be the same in the two brackets, and the integral vanishes. But if $m+n$ be even, suppose $m \succ n$. Then the terms which do not vanish are

$$(2m-1)^2 \int_{-1}^1 P_{m-1}^2 dp + (2m-5)^2 \int_{-1}^1 P_{m-3}^2 dp + \dots$$

$$= 2[(2m-1) + (2m-5) + (2m-9) + \dots + 1 \text{ (or } 3)] \text{ as } m \text{ is odd or even;}$$

and there being $\frac{m+1}{2}$ or $\frac{m}{2}$ terms in the two cases, their sum is in either

case $m(m+1)$, i.e. $\int_{-1}^1 \frac{dP_m}{dp} \frac{dP_n}{dp} dp = 0$ or $m(m+1)$ as $m+n$ is odd or even, m being the smaller of the two, m and n .

1837. We might also proceed directly thus ($m \leq n$),

$$\int_{-1}^1 \frac{dP_m}{dp} \frac{dP_n}{dp} dp = [P_n P_m]_{-1}^1 - \int_{-1}^1 P_n P_m'' dp;$$

and since n is greater than the degree of any power of p in P_m'' , the terminal integral vanishes.

Again, $(1-p^2)P_m'' - 2pP_m' + m(m+1)P_m = 0$, and therefore if $p = \pm 1$
 $P_m' = \frac{m(m+1)}{2} \frac{P_m}{p}$.

Now $\frac{P_m P_n}{p}$ is an even or an odd function of p according as $m+n$ is odd or even, and therefore $\left[\frac{P_m P_n}{p}\right]_{-1}^1 = 0$ or 2 as $m+n$ is odd or even; therefore $\int_{-1}^1 \frac{dP_m}{dp} \frac{dP_n}{dp} dp = 0$ or $m(m+1)$ according as $m+n$ is odd or even and $n \neq m$.

1838. **Differential Equation satisfied by Legendre's Functions.**

Starting again from the definition of Legendre's Coefficients, viz. $V = (1-2ph+h^2)^{-\frac{1}{2}} = \sum_0^\infty P_n h^n$, it is easy to see that they satisfy a form of Laplace's equation, without reference to the fact that when p is a cosine these coefficients are Zonal Harmonics.

For $V^2(1-2ph+h^2) = 1$ and $2 \log V + \log(1-2ph+h^2) = 0$, whence

$$\frac{\partial V}{\partial p} = hV^3, \quad \frac{\partial V}{\partial h} = (p-h)V^3, \quad \text{and} \quad p \frac{\partial V}{\partial p} - h \frac{\partial V}{\partial h} = h^2 V^3. \dots(1)$$

Again,

$$\left. \begin{aligned} \frac{\partial}{\partial p} \left\{ (1-p^2) \frac{\partial V}{\partial p} \right\} &= -2hpV^3 + 3h^2(1-p^2)V^5, \\ \frac{\partial}{\partial h} \left(h^2 \frac{\partial V}{\partial h} \right) &= (2hp-3h^2)V^3 + 3h^2(p-h)^2 V^5, \end{aligned} \right\}$$

and adding, $\frac{\partial}{\partial p} \left\{ (1-p^2) \frac{\partial V}{\partial p} \right\} + \frac{\partial}{\partial h} \left(h^2 \frac{\partial V}{\partial h} \right) = 0, \dots\dots\dots(2)$

by virtue of $V^2(1-2ph+h^2) = 1$.

Substituting $V = \sum P_n h^n$, and equating to zero the coefficient of h^n ,

$$\frac{d}{dp} \left\{ (1-p^2) \frac{dP_n}{dp} \right\} + n(n+1)P_n = 0, \dots\dots\dots(3)$$

or $(1-p^2) \frac{d^2 P_n}{dp^2} - 2p \frac{dP_n}{dp} + n(n+1)P_n = 0$ (Art. 1813).(4)

1839. Differentiating s times, we have

$$(1-p^2) \frac{d^{s+2}P_n}{dp^{s+2}} - 2(s+1)p \frac{d^{s+1}P_n}{dp^{s+1}} + \{n(n+1) - s(s+1)\} \frac{d^s P_n}{dp^s} = 0, \dots \dots (5)$$

which is known as Ivory's Equation.

If we then take as the expansion of P_n in powers of p ,

$$P_n = A_0 + A_1 \frac{p}{1!} + A_2 \frac{p^2}{2!} + A_3 \frac{p^3}{3!} + \dots,$$

it follows that

$$A_{s+2} = \{s(s+1) - n(n+1)\} A_s = -(n-s)(n+s+1) A_s, \quad s \neq n.$$

Moreover,

$$\{1 - h(2p-h)\}^{-\frac{1}{2}} = \dots + \frac{1 \cdot 3 \dots (2n-1)}{2 \cdot 4 \dots 2n} h^n (2p-h)^n + \dots$$

shows that $A_n = 1 \cdot 3 \dots (2n-1)$, also that $A_{n+1}, A_{n+2}, A_{n+3}, \dots$ are all zero, for the coefficient of h^n contains no power of p above p^n ; and this coefficient containing the powers $p^n, p^{n-2}, p^{n-4}, \dots$, it is clear that $A_{n-1}, A_{n-3}, A_{n-5}, \dots$ are also all zero.

Also, as $A_s = -A_{s+2}/(n-s)(n+s+1)$, we have

$$A_n = 1 \cdot 3 \dots (2n-1), \quad A_{n-2} = -\frac{1 \cdot 3 \dots (2n-1)}{2(2n-1)},$$

$$A_{n-4} = \frac{1 \cdot 3 \dots (2n-1)}{2 \cdot 4 (2n-1)(2n-3)}, \dots,$$

and we have the series of Art. 1801 (A).

1840. It appears that $\frac{d^n P_n}{dp^n} = 1 \cdot 3 \cdot 5 \dots (2n-1)$, and that all higher differential coefficients of P_n vanish.

If n be even, $= 2m$, the lowest order term of P_n is an arithmetical constant, viz. what is got by putting $p=0$, i.e. the coefficient of h^{2m} in $(1+h^2)^{-\frac{1}{2}}$, viz. $(-1)^m \frac{1 \cdot 3 \dots (2m-1)}{2 \cdot 4 \dots 2m}$.

If n be odd, $= 2m+1$, the lowest order term of P_n contains p , viz. $(-1)^m \frac{3 \cdot 5 \dots (2m+1)}{2 \cdot 4 \dots 2m} p$.

1841. Various Theorems.

Since $\frac{dP_{n+1}}{dp} = (2n+1)P_n + (2n-3)P_{n-2} + (2n-7)P_{n-4} + \dots$,
we have

$$\frac{dP_{n+1}}{dp} - \frac{dP_{n-1}}{dp} = (2n+1)P_n \quad \text{and} \quad P_{n+1} - P_{n-1} = (2n+1) \int_1^p P_n dp$$

and since $\frac{d}{dp} \left\{ (1-p^2) \frac{dP_n}{dp} \right\} + n(n+1)P_n = 0$,

we have $\int_1^p P_n dp = \frac{1}{n(n+1)} (p^2-1) \frac{dP_n}{dp}$;

$$\therefore P_{n+1} - P_{n-1} = \frac{2n+1}{n(n+1)} (p^2-1) \frac{dP_n}{dp}.$$

1842. Since

$$V \equiv (1-2ph+h^2)^{-\frac{1}{2}} = \Sigma P_n h^n \quad \text{and} \quad \frac{1}{V} \frac{\partial V}{\partial h} = (p-h)V^2,$$

we have $(1-2ph+h^2) \Sigma (n+1)P_{n+1} h^n = (p-h) \Sigma P_n h^n$;

whence $(n+1)P_{n+1} - 2pnP_n + (n-1)P_{n-1} = pP_n - P_{n-1}$,

i.e. $(n+1)P_{n+1} - (2n+1)pP_n + nP_{n-1} = 0$,

which forms a difference equation connecting any three successive Legendrian Coefficients.

1843. Again

$$\frac{1}{V^2} \frac{\partial V}{\partial p} = hV, \quad \text{i.e.} \quad (1-2hp+h^2) \Sigma h^{n-1} \frac{dP_n}{dp} = \Sigma h^n P_n;$$

$$\therefore \frac{dP_{n+1}}{dp} - 2p \frac{dP_n}{dp} + \frac{dP_{n-1}}{dp} = P_n;$$

and subtracting the result $\frac{dP_{n+1}}{dp} - \frac{dP_{n-1}}{dp} = (2n+1)P_n$,

we have $p \frac{dP_n}{dp} - \frac{dP_{n-1}}{dp} = nP_n$.

1844. Since $\frac{\partial V}{\partial p} = hV^3$ and $\frac{\partial V}{\partial h} = (p-h)V^3$, we have

$$(p^2-1) \frac{\partial V}{\partial p} - (1-ph) \frac{\partial V}{\partial h} = -V^3 p(1-2ph+h^2) = -Vp;$$

$$\therefore (p^2-1) \frac{\partial V}{\partial p} = \frac{\partial V}{\partial h} - p \frac{\partial}{\partial h} (Vh),$$

i.e. $(p^2-1) \Sigma h^n \frac{dP_n}{dp} = \Sigma nP_n h^{n-1} - p \Sigma nP_{n-1} h^{n-1}$.

\therefore equating coefficients of h^{n-1} , $(p^2-1) \frac{dP_{n-1}}{dp} = nP_n - npP_{n-1}$,

$$i.e. \quad P_n - pP_{n-1} = \frac{p^2-1}{n} \frac{dP_{n-1}}{dp},$$

$$or \quad (p^2-1) \frac{dP_n}{dp} = (n+1)(P_{n+1} - pP_n).$$

$$Hence \quad \frac{p^2-1}{n+1} \frac{dP_n}{dp} = P_{n+1} - pP_n = \frac{(2n+1)pP_n - nP_{n-1}}{n+1} - pP_n;$$

$$\therefore (p^2-1) \frac{dP_n}{dp} = n(pP_n - P_{n-1}).$$

We therefore have the two results,

$$\left. \begin{aligned} P_n - pP_{n-1} &= \frac{p^2-1}{n} P'_{n-1}, \\ pP_n - P_{n-1} &= \frac{p^2-1}{n} P'_n. \end{aligned} \right\}$$

$$1845. \text{ We now have } P_{n+1} - pP_n = \frac{p^2-1}{n+1} P'_n$$

$$= n \int_1^p P_n dp \left[\text{since } \frac{d}{dp} \left(\frac{1-p^2}{1} \frac{dP_n}{dp} \right) + n(n+1)P_n = 0 \right]$$

$$= n \left(\int_0^p - \int_0^1 \right) P_n dp = n \int_0^p P_n dp + C,$$

where C is a certain constant, viz. the value of P_{n+1} when $p=0$. To find C ,

$$P_{n+1} = \frac{1}{2^{n+1}(n+1)!} \frac{d^{n+1}(p^2-1)^{n+1}}{dp^{n+1}} = \frac{1}{2^{n+1}(n+1)!}$$

$$\times \frac{d^{n+1}}{dp^{n+1}} [p^{2n+2} - {}^{n+1}C_1 p^{2n} + {}^{n+1}C_2 p^{2n-2} - \dots + (-1)^r {}^{n+1}C_r p^{2n-2r+2} + \dots].$$

If n be even, each term left after $(n+1)$ differentiations contains p , and therefore in this case C vanishes. If n be odd, there is a term not containing p after the differentiations, viz. when $r = \frac{n+1}{2}$. Hence when $p=0$, we have in this case

$$C = \frac{1}{2^{n+1}(n+1)!} (-1)^{\frac{n+1}{2}} {}^{n+1}C_{\frac{n+1}{2}} (n+1)! = \frac{(-1)^{\frac{n+1}{2}}}{2^{n+1}} \frac{(n+1)!}{\left(\frac{n+1}{2}\right)!}.$$

$\therefore P_{n+1} - pP_n = n \int_0^p P_n dp + C$, where $C=0$ or $\frac{(-1)^{\frac{n+1}{2}} (n+1)!}{2^{n+1} \left(\frac{n+1}{2}\right)!}$ according as n is even or odd.

We also have by differentiation (and writing $n-1$ for n),

$$P'_n - pP'_{n-1} = nP_{n-1}.$$

1846. Since $(n+1)P_{n+1} - (2n+1)pP_n + nP_{n-1} = 0$, we have

$$(n+1)P'_{n+1} - (2n+1)pP'_n + nP'_{n-1} = (2n+1)P_n = P'_{n+1} - P'_{n-1},$$

$$nP'_{n+1} - (2n+1)pP'_n + (n+1)P'_{n-1} = 0,$$

a difference equation for the first differential coefficients of the P 's.

1847. Differentiating again,

$$nP''_{n+1} - (2n+1)pP''_n + (n+1)P''_{n-1} = (2n+1)P'_n = P''_{n+1} - P''_{n-1};$$

whence $(n-1)P''_{n+1} - (2n+1)pP''_n + (n+2)P''_{n-1} = 0$.

$$\text{Similarly } (n-2)P'''_{n+1} - (2n+1)pP'''_n + (n+3)P'''_{n-1} = 0,$$

and so on, forming a series of difference equations for the higher differential coefficients

1848. Since $pP'_n - P'_{n-1} = nP_n \dots (1)$, and $P'_n - pP'_{n-1} = nP_{n-1} \dots (2)$, (Arts. 1843 and 1845), we have, by squaring and subtracting,

$$(p^2 - 1)(P_n^2 - P_{n-1}^2) = n^2(P_n^2 - P_{n-1}^2). \dots\dots\dots(3)$$

Writing $n^2P_n^2 - (p^2 - 1)P_n'^2 = U_n$, we have

$$U_n - U_{n-1} = \{n^2 - (n-1)^2\}P_{n-1}^2 = (2n-1)P_{n-1}^2;$$

$$\therefore U_{n-1} - U_{n-2} = (2n-3)P_{n-2}^2, \text{ etc.,}$$

and $U_1 = P_1^2 - (p^2 - 1)P_1'^2 = 1 = P_0^2$.

$$\text{Hence } n^2P_n^2 - (p^2 - 1)P_n'^2 = P_0^2 + 3P_1^2 + 5P_2^2 + \dots + (2n-1)P_{n-1}^2. \dots\dots\dots(4)$$

1849. Again differentiating (1) and (2) r times, and again squaring and subtracting,

$$(p^2 - 1)\{(P_n^{(r+1)})^2 - (P_{n-1}^{(r+1)})^2\} = (n-r)^2(P_n^{(r)})^2 - (n+r)^2(P_{n-1}^{(r)})^2,$$

or writing $V_n = (n-r)^2(P_n^{(r)})^2 - (p^2 - 1)(P_n^{(r+1)})^2$,

$$V_n - V_{n-1} = \{(n+r)^2 - (n-1-r)^2\}(P_{n-1}^{(r)})^2 = (2n-1)(2r+1)(P_{n-1}^{(r)})^2,$$

and if $n=r$, $V_r=0$; if $n=r+1$, $V_{r+1} = (2r+1)^2(P_r^{(r)})^2$;

$$\text{whence } \frac{V_n}{2r+1} = (2n-1)(P_{n-1}^{(r)})^2 + (2n-3)(P_{n-2}^{(r)})^2 + \dots + (2r+1)(P_r^{(r)})^2,$$

or completing the series with zero terms and reversing the order,

$$V_n/(2r+1) = (P_0^{(r)})^2 + 3(P_1^{(r)})^2 + 5(P_2^{(r)})^2 + \dots + (2n-1)(P_{n-1}^{(r)})^2.$$

1850. **Illustrative Example.**

To find a series S which will assume a constant value A at all points on the surface of the unit sphere in the northern hemisphere, and a constant value B at all points of the surface in the southern hemisphere.

Suppose the series to be $S \equiv C_0 + C_1P_1 + C_2P_2 + C_3P_3 + \dots$

Then $S=A$ from $p=0$ to $p=1$, $S=B$ from $p=-1$ to $p=0$. Therefore multiplying by P_n ,

$$\int_{-1}^1 C_n P_n^2 dp = \int_{-1}^0 B P_n dp + \int_0^1 A P_n dp; \text{ and } \int_{-1}^0 P_n dp = (-1)^n \int_0^1 P_n dp;$$

$$\therefore \frac{2}{2n+1} C_n = \{A + (-1)^n B\} \int_0^1 P_n dp = -\frac{A + (-1)^n B}{n(n+1)} \int_0^1 \frac{d}{dp} \left\{ (1-p^2) \frac{dP_n}{dp} \right\} dp$$

$$= -\frac{A + (-1)^n B}{n(n+1)} \left[(1-p^2) \frac{dP_n}{dp} \right]_0^1$$

$$= \frac{A+B}{n(n+1)} \left(\frac{dP_n}{dp} \right)_{p=0} = 0, \text{ if } n \text{ be even } (=2i)$$

and $\neq 0$,

$$= \frac{A-B}{(2i+1)(2i+2)} \cdot \frac{3 \cdot 5 \dots (2i+1)}{2 \cdot 4 \dots 2i} (-1)^i, \text{ if } n \text{ be odd } (=2i+1);$$

$$\therefore C_{2i} = 0, (i > 0); \quad C_{2i+1} = (-1)^i \frac{(4i+3) 3 \cdot 5 \dots (2i-1)}{2 \cdot 4 \dots (2i+2)} \cdot (A-B).$$

or

Also, if $n=0$, $C_0 = \frac{1}{2}(A+B) \int_0^1 dp = \frac{A+B}{2}$;

if $n=1$, $C_1 = \frac{3}{2}(A-B) \int_0^1 p dp = \frac{3}{2}(A-B)$.

Hence the series required is

$$S = \frac{A+B}{2} P_0 + \frac{A-B}{2} \left\{ \frac{3P_1}{1 \cdot 2} - \frac{3}{2} \cdot \frac{7P_3}{3 \cdot 4} + \frac{3 \cdot 5}{2 \cdot 4} \frac{11P_5}{5 \cdot 6} - \dots \right\}.$$

1851. In case the distribution be symmetrical about some other axis than Oz , the zonal harmonics may be expressed in terms of harmonics with Oz for axis.

1852. For instance, if we require an expression in terms of Harmonics

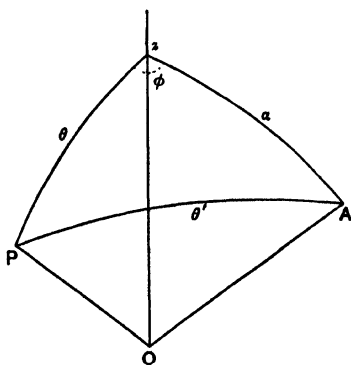

Fig. 594.

with Oz for axis, where the value of the function is A over the whole hemisphere with OA for axis and nearer to A , and is B over the hemisphere more remote from A , then we have just found an expression for such a function in terms of Zonal Harmonics with axis OA , viz. $\sum C_n P_n$.

If P be any point on the spherical surface, and we put $\hat{z}OA = a$, $\hat{z}OP = \theta$, $POA = \theta'$, $AzP = \phi$, we have, from the spherical triangle AzP ,

$$\cos \theta' = \cos a \cos \theta + \sin a \sin \theta \cos \phi,$$

and $P_n(\cos \theta')$ becomes a spherical

Surface Harmonic Q_n expressed in terms of θ , ϕ , and the value of the function sought will be

$$S = \frac{A+B}{2} Q_0 + \frac{A-B}{2} \left\{ \frac{3Q_1}{1 \cdot 2} - \frac{3}{2} \cdot \frac{7Q_3}{3 \cdot 4} + \frac{3 \cdot 5}{2 \cdot 4} \frac{11Q_5}{5 \cdot 6} - \text{etc.} \right\}.$$

1853. LIST OF WORKING FORMULAE FOR LEGENDRE'S COEFFICIENTS.

(Differentiations with regard to p are denoted by accents.)

1. $\frac{d}{dp} \{(1-p^2)P_n'\} + n(n+1)P_n = 0$; $(1-p^2)P_n'' - 2pP_n' + n(n+1)P_n = 0$;

$$\frac{d^2 P_n}{d\theta^2} + \cot \theta \frac{dP_n}{d\theta} + n(n+1)P_n = 0; \quad p = \mu = \cos \theta.$$

2. Rodrigues' Formula; $P_n = \frac{1}{2^n n!} \frac{d^n}{dp^n} (p^2-1)^n$.

3. $P_n = \frac{1 \cdot 3 \cdot 5 \dots (2n-1)}{n!} \left\{ p^n - \frac{n(n-1)}{2(2n-1)} p^{n-2} \right.$
 $\left. + \frac{n(n-1)(n-2)(n-3)}{2 \cdot 4(2n-1)(2n-3)} p^{n-4} + \dots \right\}$.

4. $P_0 = 1$, $P_1 = p$, $P_2 = \frac{3}{2}p^2 - \frac{1}{2}$, $P_3 = \frac{5}{2}p^3 - \frac{3}{2}p$,

$$P_4 = \frac{5 \cdot 7}{2 \cdot 4} p^4 - 2 \frac{3 \cdot 5}{2 \cdot 4} p^2 + \frac{1 \cdot 3}{2 \cdot 4}, \quad P_5 = \frac{7 \cdot 9}{2 \cdot 4} p^5 - 2 \frac{5 \cdot 7}{2 \cdot 4} p^3 + \frac{3 \cdot 5}{2 \cdot 4} p, \text{ etc.}$$

5. $p^n = \frac{n!}{1 \cdot 3 \cdot 5 \dots (2n+1)} \left\{ (2n+1)P_n + (2n-3) \frac{2n+1}{2} P_{n-2} \right.$
 $\left. + (2n-7) \frac{(2n+1)(2n-1)}{2 \cdot 4} P_{n-4} + \dots \right\}$.

6. $1 = P_0$, $p = P_1$, $p^2 = \frac{1}{3}P_0 + \frac{2}{3}P_2$, $p^3 = \frac{2}{3}P_1 + \frac{1}{3}P_3$,

$$p^4 = \frac{1}{5}P_0 + \frac{4}{5}P_2 + \frac{4}{5}P_4, \quad p^5 = \frac{2}{5}P_1 + \frac{4}{5}P_3 + \frac{2}{5}P_5, \text{ etc.}$$

7. $P_n = \frac{1}{\pi} \int_0^\pi (p \pm \sqrt{p^2-1} \cos \chi)^n d\chi = \frac{1}{\pi} \int_0^\pi \frac{d\chi}{(p \mp \sqrt{p^2-1} \cos \chi)^{n+1}}$.

8. $\int_{-1}^1 P_m P_n dp = 0$ if $m \neq n$, $\int_{-1}^1 P_n^2 dp = \frac{2}{2n+1}$.

9. $P_n' = (2n-1)P_{n-1} + (2n-5)P_{n-3} + (2n-9)P_{n-5} + \dots$ to P_0 or $3P_1$.

10. $P_{n+1}' - P_{n-1}' = (2n+1)P_n$. 11. $P_{n+1} - P_{n-1} = \frac{(2n+1)}{n(n+1)} (p^2-1)P_n'$.

12. $(n+1)P_{n+1} - (2n+1)pP_n + nP_{n-1} = 0$.

13. $nP_{n+1}' - (2n+1)pP_n' + (n+1)P_{n-1}' = 0$.

14. $pP_n' - P_{n-1}' = nP_n$, $P_n' - pP_{n-1}' = nP_{n-1}$.

15. $P_n - pP_{n-1} = \frac{p^2-1}{n} P_{n-1}'$, $pP_n - P_{n-1} = \frac{p^2-1}{n} P_n'$.

16. $P_{n+1} - pP_n = n \int_0^p P_n dp + C$. $C=0$, if n be even, and

$$= \frac{(-1)^{\frac{n+1}{2}}}{2^{n+1}} \frac{(n+1)!}{\left\{ \left(\frac{n+1}{2} \right)! \right\}^2} \text{ if } n \text{ be odd.}$$

17. $1 + 3P_1 + 5P_3 + 7P_5 + \dots = 0$ for all values of p except $p=1$, and then is ∞ . See Art. 1857.

1854. The Roots of $P_n=0$.

Between any two real roots of a rational algebraic equation $f(x)=0$, at least one real root of $f'(x)=0$ must lie; and if the roots of the equation $f(x)=0$ are all real, the roots of $f'(x)=0$ are all real, and separated by the roots of $f(x)=0$, and lie between the extreme roots of $f(x)=0$. The roots of $f''(x)=0$ are therefore all real and lie between the extreme roots of $f'(x)=0$, and therefore between the extreme roots of $f(x)=0$; and similarly for all the derived functions.

Hence the roots of $P_n=0$, *i.e.* of $\frac{d^n}{dp^n}(p^2-1)^n=0$, lie between $+1$ and -1 , for the roots of $(p^2-1)^n$ are all real, and either $+1$ or -1 .

Also no two roots of $P_n=0$ can be equal. For if they could, $P_n=0$ and $\frac{dP_n}{dp}=0$ would have a common root. But

$$(p^2-1)\frac{d^2P_n}{dp^2}+2p\frac{dP_n}{dp}=n(n+1)P_n$$

and

$(p^2-1)\frac{d^{s+2}P_n}{dp^{s+2}}+2(s+1)p\frac{d^{s+1}P_n}{dp^{s+1}}+\{s(s+1)-n(n+1)\}\frac{d^sP_n}{dp^s}=0$
 for all positive integral values of s . So that if $P_n=0$ and $\frac{dP_n}{dp}=0$, we have $\frac{d^2P_n}{dp^2}$, $\frac{d^3P_n}{dp^3}$, etc., all zero. But this is contrary to the result $\frac{d^nP_n}{dp^n}=1.3.5\dots(2n-1)$ (Art. 1840).

Hence the roots of $P_n=0$ are all different and lie between $+1$ and -1 .

It is obvious from the forms of P_n shown in Art. 1818, that when n is odd one of the roots is zero. Also, that in any case as the powers of p are either all odd or all even, all the other roots occur in pairs, one positive and one negative, of each magnitude.

1855. The Curves $r=aP_0$, $r=aP_1$, $r=aP_2$, etc., are readily traced.

(1) $r=aP_0=a$ is a circle, centre at the origin and radius a (Fig. 595).

(2) $r=aP_1=a\cos\theta$ is a circle of radius $\frac{a}{2}$ touching the y -axis at the origin (Fig. 596).

(3) $r = aP_2 = a \frac{3 \cos^2 \theta - 1}{2}$ has max. rad. vect. $r = a$, $r = \frac{a}{2}$, where $\theta = 0$ or π , and $\theta = (2n+1)\frac{\pi}{2}$, and touches the lines $\theta = \pm \cos^{-1} \frac{1}{3}$ (Fig. 597).

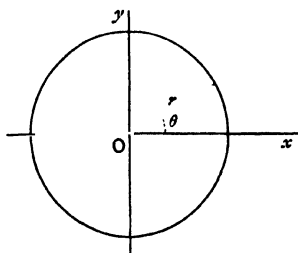

Fig. 595.

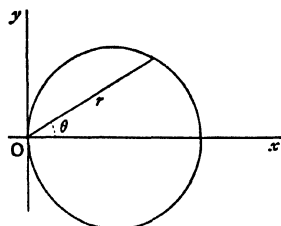

Fig. 596.

(4) $r = aP_3 = a \frac{5 \cos^3 \theta - 3 \cos \theta}{2}$ has max. rad. vect. a and $a/\sqrt{5}$, where $\theta = 0$ and $\pm \cos^{-1} \frac{1}{5}$, and touches $\theta = \pm \cos^{-1} \frac{\sqrt{3}}{5}$ and $\theta = \frac{\pi}{2}$ (Fig. 598).

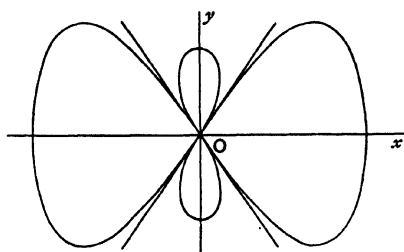

Fig. 597.

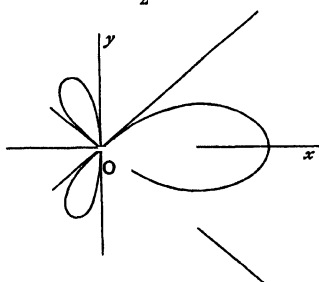

Fig. 598.

(5) $r = aP_4 = a \frac{35 \cos^4 \theta - 30 \cos^2 \theta + 3}{8}$ has max. rad. vect. a , where $\theta = 0$; $\frac{3a}{8}$, where $\theta = \frac{\pi}{2}$; $\frac{3a}{7}$ if $\theta = \cos^{-1} \sqrt{\frac{3}{7}}$, etc., and touches $\theta = \cos^{-1} \left\{ \pm \sqrt{\frac{15 \pm 2\sqrt{30}}{35}} \right\}$; and so on for those of higher orders (Fig. 599).

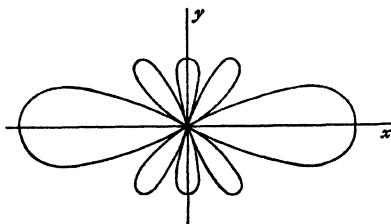

Fig. 599.

1856. We may now note the effect of a small harmonic when superposed upon the graph of a curve otherwise circular by tracing curves of the type $r = a(1 + \epsilon P_n)$, where ϵ is a small positive fraction. We merely have to add with their proper signs the radii of the curves traced, multiplied by ϵ , to those of the circle.

(1) $r = a(1 + \epsilon P_0)$ means that the radius of the circle is slightly but uniformly increased (Fig. 600).

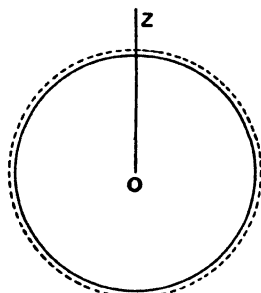

Fig. 600.

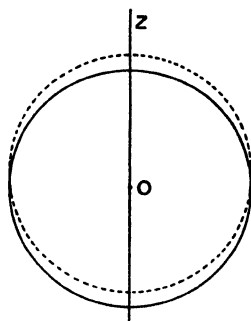

Fig. 601.

(2) $r = a(1 + \epsilon P_1)$. Here the new locus shows the substitution of a Limaçon locus for the circle. The Limaçon lies partly inside and partly outside the circle (Fig. 601).

(3) $r = a(1 + \epsilon P_2)$. This change substitutes an oval for the circle, which is thereby extended at the poles, and contracted at the ends of the perpendicular axis (Fig. 602).

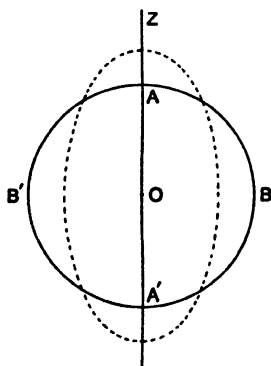

Fig. 602.

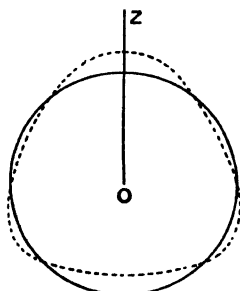

Fig. 603.

(4) $r = a(1 + \epsilon P_3)$. Here the circle is extended in three places, and contracted in three other places (Fig. 603).

(5) $r = a(1 + \epsilon P_4)$. Here the circle is extended in four places and contracted in four others, and so on (Fig. 604).

If we revolve these curves about the axis, the corresponding shapes of the solids of form $r = a(1 + \epsilon P_n)$ can be readily imagined; $r = a$ representing a sphere, and ϵ small and positive. The shape is that of a sphere slightly swollen out at the pole, and surrounded by belts alternately lower than and higher than the normal level of the spherical surface, and when n is even the equatorial plane is a plane of symmetry.

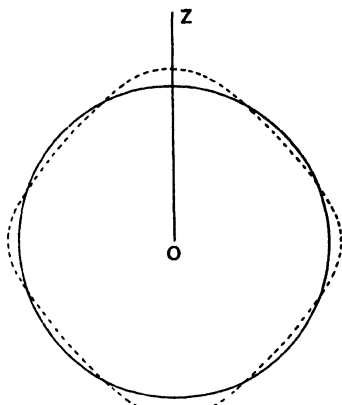

Fig. 604.

If the radius of the sphere be affected by other harmonics, *e.g.* $r = a(1 + \epsilon P_n + \epsilon' P_m)$, the locus can be similarly constructed by superposition, *i.e.* the addition of the separate effects to the radius of the sphere.

1857. **A Remarkable Discontinuity.**

The expression $1 + 3P_1 + 5P_2 + 7P_3 + \dots + (2n + 1)P_n + \dots$ is discontinuous. It vanishes for all values of p except $p = 1$, when it becomes infinite.

For $(1 - 2ph + h^2)^{-\frac{1}{2}} = \sum_0^{\infty} P_n h^n$, and differentiating,

$$(p - h)(1 - 2ph + h^2)^{-\frac{3}{2}} = \sum_1^{\infty} n P_n h^{n-1}.$$

Multiplying the second by $2h$, and adding to the first,

$$(1 - h^2)(1 - 2ph + h^2)^{-\frac{3}{2}} = \sum_1^{\infty} (2n + 1) P_n h^n,$$

and putting $h = 1$, $\sum_0^{\infty} (2n + 1) P_n = 0$

for all values of p except when $p = 1$, *i.e.* at the pole of the sphere, and there the expression becomes infinite, being the limit when $h \rightarrow 1$ of $\frac{1 + h}{(1 - h)^2}$.

Similarly putting $h = -1$,

$$1 - 3P_1 + 5P_2 - 7P_3 + \dots + (2n + 1)(-1)^n P_n + \dots = 0$$

except when $p = -1$, *i.e.* at the opposite pole, and there it becomes infinite.

$$\begin{aligned} & \text{We also have } \int_{-1}^1 \int_0^{2\pi} (1 + 3P_1h + 5P_2h^2 + \dots) dp d\phi \\ &= \int_0^\pi \int_0^{2\pi} \sin \theta d\theta d\phi \cdot \frac{1-h^2}{(1-2h \cos \theta + h^2)^{\frac{3}{2}}} = 2\pi \frac{1-h^2}{h} \left[-\frac{1}{(1-2h \cos \theta + h^2)^{\frac{1}{2}}} \right]_0^\pi \\ &= 2\pi \frac{1-h^2}{h} \left[-\frac{1}{1+h} + \frac{1}{1-h} \right] = 2\pi \cdot 2 = 4\pi. \end{aligned}$$

1858. **Physical Meaning.**

The potentials produced at points within or without a spherical surface of area S and radius r_0 by a layer of matter on the surface of surface density $(2n+1)P_n/S$ are respectively $P_n r^n / r_0^{n+1}$ and $P_n r_0^n / r^{n+1}$. For both these expressions satisfy Laplace's Equation; the second vanishes at ∞ and Green's surface condition is satisfied, *viz.* that the difference of attractions on two points on the same normal, one just outside and one just inside, is to be $4\pi \times$ surface density. And such a solution is unique.

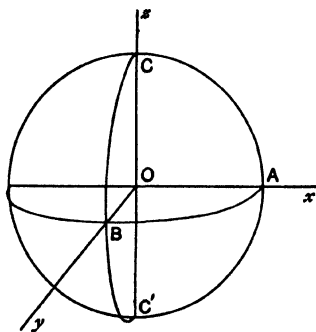

Fig. 605.

Take a particle of mass unity situated at the pole C of the sphere with centre the origin O and radius r_0 . The potential produced at any

point P distant r from O in colatitude $\cos^{-1} p$ is

$$(r_0^2 - 2pr_0r + r^2)^{-\frac{1}{2}} = \frac{1}{r_0} \sum P_n \left(\frac{r}{r_0}\right)^n \quad \text{or} \quad \frac{1}{r} \sum P_n \left(\frac{r_0}{r}\right)^n \quad \text{as } r < \text{or } > r_0, \dots (1)$$

and we have seen that an internal potential $P_n \frac{r^n}{r_0^{n+1}}$ and an external potential $P_n \frac{r_0^n}{r^{n+1}}$ are produced by a distribution of surface density which varies as $(2n+1)P_n$.

Hence the potentials (1) are produced by a distribution $\sum_0^\infty (2n+1)P_n$.

But the distribution producing a given potential inside and outside is unique, and we have seen that a concentration into a point at the pole C does produce it. Therefore the distribution $\sum_0^\infty (2n+1)P_n$ must represent a concentration of matter into a single point at the pole C , and must therefore vanish at all points of the sphere except at the pole, where it must become infinite.

This theorem is of great service in obtaining expressions for the potential in the case of discontinuous distributions of matter.

1859. Let P be a point at which there is no attracting matter, O the origin, Q the position of an attracting element of mass m ; $OP=r$, $OQ=r'$, $PQ=R$. Suppose the attracting body to be a homogeneous solid of revolution whose axis is taken as the z -axis. Then the potential at P is expressible in the form $V=\Sigma\frac{m}{R}=\Sigma_0^{\infty}A_nP_nr^n+\Sigma_0^{\infty}B_n\frac{P_n}{r^n}$, where A_n , B_n are constants; the first summation $\Sigma A_nP_nr^n$ referring to that for all those particles for which $r < r'$, and the second for those for which $r > r'$, and this is a unique solution. Now supposing that the potential is known for these two parts in convergent series for each such portion at each point on the axis, where $P_n=1$, then the values of A_n and B_n are known for all values of n . Therefore, assuming that the potential at any point on the axis is expressible as $\Sigma\left(A_nr^n+\frac{B_n}{r^n}\right)$, its value at any point off the axis may be at once written as $\Sigma\left(A_nr^n+\frac{B_n}{r^n}\right)P_n$.

1860. Consider the expression

$$\sum_0^{\infty}(2n+1)P_n(\lambda)P_n(\mu),$$

where $P_n(\lambda)$, $P_n(\mu)$ are Zonal Harmonics and λ , μ the cosines of the colatitudes of two points.

Take the case of a circular wire of infinitesimal section. Take as origin the centre of a sphere of radius r_0 of which the wire forms a small circle, and let the z -axis be the normal to the plane of the wire. Let M be the mass of the wire considered of uniform line-density.

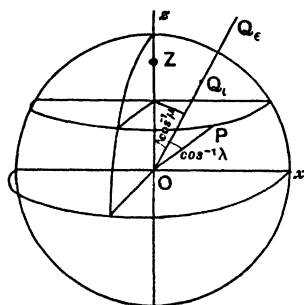

Fig. 606.

The potential of the wire at a point Z , $(0, 0, z)$ on the z -axis is $M(r_0^2 - 2\lambda r_0 z + z^2)^{-\frac{1}{2}}$, where $\cos^{-1}\lambda$ is the angular radius of the small circle, i.e. $\frac{M}{r_0} \sum_0^{\infty} P_n(\lambda) \left(\frac{z}{r_0}\right)^n$ or $\frac{M}{z} \sum_0^{\infty} P_n(\lambda) \left(\frac{r_0}{z}\right)^n$ as $z <$ or $> r_0$, and therefore at a point Q in colatitude $\cos^{-1}\mu$ and distant r from O , the potential is $\frac{M}{r_0} \sum_0^{\infty} P_n(\lambda) P_n(\mu) \left(\frac{r}{r_0}\right)^n$ at Q_t , where $r < r_0$; and $\frac{M}{r} \sum_0^{\infty} P_n(\lambda) P_n(\mu) \left(\frac{r_0}{r}\right)^n$ at Q_e , where $r > r_0$.

Now $(2n+1)P_n(\lambda)$ is the law of distribution of surface density giving a potential $\propto P_n r^n$ within and $\propto P_n/r^{n+1}$ without the sphere. Hence a surface density $\sum_0^\infty (2n+1)P_n(\lambda)P_n(\mu)$ will give the same potentials as it has been seen that the distribution of a uniform line density along a circular wire gives, and is unique. Therefore the expression $\sum_0^\infty (2n+1)P_n(\lambda)P_n(\mu)$ must be zero at all points of the spherical surface except for such points as lie along the small circle of angular radius $\cos^{-1}\lambda$, where the surface density is infinite but the line density finite. That is, the expression is zero except where $\lambda = \mu$, where it is infinite.

The theorem is similar to one occurring in Poisson's discussion of Fourier's Theorem, Chapter XXXV.

1861. Practical Method of Expression of a Rational Integral Algebraic Function of x, y, z in Terms of Harmonics on Unit Sphere.

Let $H_n \equiv Ax^n + x^{n-1}(By + Cz) + x^{n-2}(Dy^2 + Eyz + Fz^2) + \dots$ be the general homogeneous expression of degree n , which contains $\frac{1}{2}(n+1)(n+2)$ coefficients. Subtract and add

$(x^2 + y^2 + z^2)H_{n-2}$, where $H_{n-2} \equiv A'x^{n-2} + x^{n-3}(B'y + C'z) + \dots$, which contains $\frac{1}{2}(n-1)n$ coefficients A', B', C', \dots to be found.

Apply the operator ∇^2 to $H_n - (x^2 + y^2 + z^2)H_{n-2}$, viz.

$$(A - A')x^n + \dots$$

We then obtain, after this operation, by equating to zero each resulting coefficient, $\frac{1}{2}(n-1)n$ equations to determine the $\frac{1}{2}(n-1)n$ quantities A', B', C', \dots , and $H_n - (x^2 + y^2 + z^2)H_{n-2}$ becomes a spherical harmonic of degree n . Next apply the same mode of procedure to H_{n-2} , and so on. We have then expressed H_n in the form

$$r^n Y_n + r^2(r^{n-2} Y_{n-2}) + r^4(r^{n-4} Y_{n-4}) + \dots$$

or $r^n(Y_n + Y_{n-2} + Y_{n-4} + \dots)$;

and if we take our sphere as $r=1$, we have

$$Y_n + Y_{n-2} + Y_{n-4} + \dots,$$

a series of surface harmonics.

If the rational integral algebraic function considered consist of groups of terms of different degrees, the same rule will apply to the terms of each group.

As a preliminary to such procedure, all terms which are obviously already solid harmonics should be laid aside, to be restored when the process is completed, amongst the other harmonics of their own degrees.

1862. Ex. Express

$$\phi = a_1x + a_2y + a_3z + b_1x^2 + b_2y^2 + b_3z^2 + b_4yz + b_5zx + b_6xy + cxyz$$

as a series in the form $r^3Y_3 + r^2Y_2 + rY_1 + Y_0$.

We only need consider the terms $b_1x^2 + b_2y^2 + b_3z^2$,

i.e. $(b_1 - \lambda)x^2 + (b_2 - \lambda)y^2 + (b_3 - \lambda)z^2 + \lambda(x^2 + y^2 + z^2)$,

and $\nabla^2[(b_1 - \lambda)x^2 + (b_2 - \lambda)y^2 + (b_3 - \lambda)z^2] = 2(b_1 + b_2 + b_3 - 3\lambda) = 0$
 if $\lambda = \frac{1}{3}(b_1 + b_2 + b_3)$;

$$\therefore \phi = cxyz + \left[\frac{2b_1 - b_2 - b_3}{3} r^2 + \frac{2b_2 - b_3 - b_1}{3} y^2 + \frac{2b_3 - b_1 - b_2}{3} z^2 \right. \\ \left. + b_4yz + b_5zx + b_6xy \right] \\ + [a_1x + a_2y + a_3z] + \frac{b_1 + b_2 + b_3}{3} r^2,$$

which on the surface $r = 1$ is of form $Y_3 + Y_2 + Y_1 + Y_0$.

1863. If the function be not already expressed in Cartesians, it is usually best to express it so first.

Ex. Express $\sin^4 \theta \sin^2 2\phi$ in terms of Surface Harmonics.

$$\sin^4 \theta \sin^2 2\phi = 4(\sin \theta \cos \phi)^2 (\sin \theta \sin \phi)^2 = 4x^2y^2 \quad (r=1),$$

and proceeding as before,

$$= 4(x^2y^2 - r^2(\frac{4}{3}x^2 + \frac{4}{3}y^2 - \frac{1}{3}z^2)) + \frac{4}{3}r^2(\frac{8}{3}x^2 + \frac{8}{3}y^2 - \frac{1}{3}z^2) + \frac{4}{3} \cdot \frac{4}{3}r^4;$$

and putting $x = \sin \theta \cos \phi$, $y = \sin \theta \sin \phi$, $z = \cos \theta$, and $r = 1$, we have a result of the required form $Y_4 + Y_2 + Y_0$.

1864. Change of Axis of a Legendre's Coefficient.

If P_n be Legendre's coefficient of order n , we have the series of solid harmonics

$$P_1r = z; \quad P_2r^2 = \frac{3p^2 - 1}{2} r^2 = \frac{3z^2 - r^2}{2} = \frac{2z^2 - x^2 - y^2}{2};$$

$$P_3r^3 = \frac{5p^3 - 3p}{2} r^3 = \frac{5z^3 - 3zr^2}{2} = \frac{2z^3 - 3zx^2 - 3zy^2}{2}; \quad \text{etc.}$$

Writing $lX + mY + nZ$ for z , where $l^2 + m^2 + n^2 = 1$ and $x^2 + y^2 + z^2 = X^2 + Y^2 + Z^2 = R^2$, these solid harmonics become, when referred to new axes $OX, OY, OZ, lX + mY + nZ$;

$$\frac{3(lX + mY + nZ)^2 - (X^2 + Y^2 + Z^2)}{2}; \quad \frac{5(lX + mY + nZ)^3 - 3R^2(lX + mY + nZ)}{2}; \quad \text{etc.}$$

and the axis of this set of harmonics is $\frac{X}{l} = \frac{Y}{m} = \frac{Z}{n}$, viz. OA (Fig. 607).

If we transform to polars so that this line is given by $l = \sin \theta' \cos \phi'$, $m = \sin \theta' \sin \phi'$, $n = \cos \theta'$, and $X = R \sin \theta \cos \phi$,

$Y=R \sin \theta \sin \phi$, $Z=R \cos \theta$, the axis OA of the new set of harmonics is inclined to the new Z -axis at an angle θ' and the azimuthal angle is ϕ' , and the expression

$$\frac{lX+mY+nZ}{R} \text{ is } \cos \theta \cos \theta' + \sin \theta \sin \theta' \cos (\phi - \phi'),$$

and is still a *cosine*, viz. the cosine of the angle between the original axis OA and the direction OP of the point X, Y, Z .

If then we take $r \equiv R = 1$, and if, instead of p , we write

$$\cos \theta \cos \theta' + \sin \theta \sin \theta' \cos (\phi - \phi'),$$

we get a more general form of Harmonic than the Legendre's Coefficients. There are now two independent variables θ and ϕ , θ' and ϕ' being regarded as known.

The Harmonics in their new form are known as **Laplace's Coefficients** and denoted by $Y_1, Y_2, Y_3 \dots$. Thus for Legendre's Coefficients the z -axis OA is taken as the axis of the system, and $AOP = \theta$. In Laplace's Coefficients the axis of the system is the line θ', ϕ' , and the direction of P is θ, ϕ .

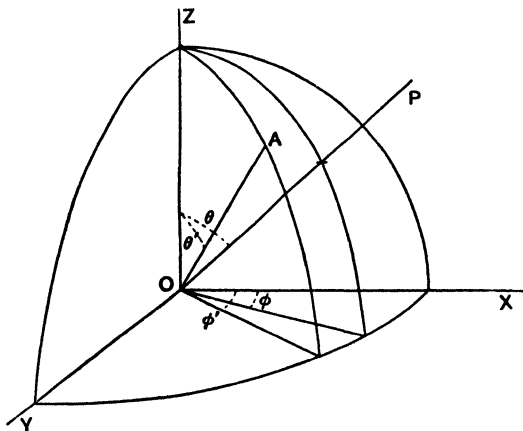

Fig. 607.

The curves for which \widehat{AOP} is constant are a set of parallels about the axis of the coefficient in either case, viz. $\cos \theta = \text{const.}$ for a Legendre's Coefficient, and

$\cos \theta \cos \theta' + \sin \theta \sin \theta' \cos \overline{\phi - \phi'} = \text{const.}$ for a Laplace's Coeff. Both sets are Zonal Surface Harmonics. When multiplied by r^n , i.e. OP^n , they are Zonal Solid Harmonics. If we further

transform coordinates so that Z becomes the distance from any other fixed plane through O , the Solid Zonal Harmonic remains a Solid Zonal Harmonic and the Surface Zonal Harmonic remains a Surface Zonal Harmonic.

1865. **Tesseral and Sectorial Harmonics.**

Take the case of an unreal plane $Z \equiv z + \alpha(x + iy)$, $l = \alpha$, $m = \alpha i$, $n = 1$, so that $l^2 + m^2 + n^2 = 1$.

Then, if $F(z)$ is a Solid Spherical Harmonic, so also is $F\{z + \alpha(x + iy)\}$, *i.e.*

$$F(z) + \frac{\alpha}{1!}(x + iy)F'(z) + \frac{\alpha^2}{2!}(x + iy)^2F''(z) + \dots + \frac{\alpha^s}{s!}(x + iy)^sF^{(s)}(z) + \dots$$

also satisfies Laplace's Equation $\nabla^2 V = 0$ for all values of α , and the equation being linear each term of this expansion will also do so, and will itself be a Solid Spherical Harmonic; and taking either sign for i , we have new forms of Solid Spherical Harmonics $(x \pm iy)^s F^{(s)}(z)$. Also their sum and difference are also Solid Spherical Harmonics. Therefore transforming to polars with $r = 1$, $x = \sin \theta \cos \phi$, $y = \sin \theta \sin \phi$, $z = \cos \theta$, $\sin^s \theta \cos s\phi F^{(s)}(\cos \theta)$ and $\sin^s \theta \sin s\phi F^{(s)}(\cos \theta)$, or, what is the same thing, $(1 - p^2)^{\frac{s}{2}} \cos s\phi \frac{d^s P_n}{d\theta^s}$ and $(1 - p^2)^{\frac{s}{2}} \sin s\phi \frac{d^s P_n}{d\theta^s}$ are new forms of Spherical Surface Harmonic functions of θ , ϕ .

1866. These new Harmonics are called Tesseral Harmonics of degree n and order s . When $s = n$,

$$\frac{d^s P_n}{dp^s} = \frac{d^n P_n}{dp^n} = 1.3.5 \dots (2n - 1), \text{ a constant.}$$

Rejecting the constant, $(1 - p^2)^{\frac{n}{2}} \cos n\phi$ and $(1 - p^2)^{\frac{n}{2}} \sin n\phi$ are called Sectorial Harmonics of degree n .

It has been seen that in the case of a Zonal Harmonic its vanishing gives an equation of degree n in p with all its roots real, and the spherical surface is mapped out into a series of belts or zones by circular sections at right angles to the axis of the Harmonic, the angular radii of which sections are determined by the roots of this equation.

In a Sectorial Harmonic the roots $p^2 = 1$ give the poles in which the axis of the Harmonics cuts the sphere. But in addition we have, by the vanishing of such an Harmonic,

$\cos n\phi=0$ or $\sin n\phi=0$, as the case may be, which indicate roots $n\phi=2\lambda\pi+\frac{\pi}{2}$ or $\lambda\pi$; *i.e.* a set of great circle sections through the axis of the system of Harmonics, which therefore map out the surface of the sphere by meridians.

In the case of a Tesseral Harmonic the vanishing of $(1-p^2)^{\frac{s}{2}} \frac{\cos s\phi}{\sin s\phi} \frac{d^s P_n}{dp^s}$ would give in addition to (i) the poles, (ii) the meridians (in number s), the solutions of $\frac{d^s P_n}{dp^s}=0$. This is an equation of degree $n-s$ in p determining $n-s$ small circles whose planes are at right angles to the axis of the system.

The surface is now mapped out by these meridians and small circles into a set of tile-shaped elements or tesserae. Thus to any Zonal Harmonic correspond new Harmonics, Tesseral and Sectorial, which are all species of **Laplace's Functions**.

1867. *The most general homogeneous function which is rational with respect to $x=\sin\theta\cos\phi$, $y=\sin\theta\sin\phi$, $z=\cos\theta$, and of the n^{th} degree, for which r is put = 1, and which satisfies the equation*

$$\frac{\partial}{\partial\mu} \left\{ (1-\mu^2) \frac{\partial Q}{\partial\mu} \right\} + \frac{1}{1-\mu^2} \frac{\partial^2 Q}{\partial\phi^2} + n(n+1)Q = 0,$$

is $Q = a_0 P_n + \sum_1^n (a_k \cos k\phi + b_k \sin k\phi) \sin^k \theta \frac{\partial^k P_n}{\partial\mu^k},$

where P_n is the Legendrian coefficient of the n^{th} order.

For considering the expression $A_k \cos k\phi + B_k \sin k\phi$, $A_k \cos k\phi$ could not be a rational integral algebraic function of $\sin\theta\sin\phi$, $\sin\theta\cos\phi$, $\cos\theta$ unless A_k itself contains a factor $\sin^k \theta$.

Put $Q \equiv \cos k\phi \sin^k \theta \cdot v \equiv \cos k\phi \cdot u$, say. Then the differential equation becomes $(1-\mu^2) \frac{d^2 u}{d\mu^2} - 2\mu \frac{du}{d\mu} + \left\{ n(n+1) - \frac{k^2}{1-\mu^2} \right\} u = 0$; and writing $u = (1-\mu^2)^{\frac{k}{2}} v$, we have

$$(1-\mu^2) \frac{\partial^2 v}{\partial\mu^2} - 2\mu(k+1) \frac{\partial v}{\partial\mu} + \{n(n+1) - k(k+1)\} v = 0,$$

which is Ivory's Equation of Art. 1839, where

$$v = \frac{\partial^k}{\partial \mu^k} \left\{ AP_n + BP_n \int \frac{d\mu}{P_n^2(1-\mu^2)} \right\} \quad (\text{Art. 1816}).$$

But as we require the *integral* function of μ which will satisfy the general equation, we take $B=0$. Hence

$$Q = A \cos k\phi \sin^k \theta \frac{\partial^k P_n}{\partial \mu^n}$$

satisfies the equation. And in the same way, starting with $Q = \sin k\phi \sin^k \theta \cdot v$, we should have arrived at a solution $Q = B \sin k\phi \sin^k \theta \frac{\partial^k P_n}{\partial \mu^n}$; and these solutions hold for all positive integral values of k . Hence the most general solution of the kind required, viz. homogeneous (with $r=1$) and a rational integral algebraic function of $\sin \theta \cos \phi$, $\sin \theta \sin \phi$, $\cos \theta$, is that stated above, viz.

$$Q = a_0 P_n + \sum_1^n (a_k \cos k\phi + b_k \sin k\phi) \sin^k \theta \frac{\partial^k P_n}{\partial \mu^k},$$

where $\mu = \cos \theta$, and contains $2n+1$ arbitrary constants. It is clearly useless to continue the summation for values of $k > n$, for the last factor would vanish for such terms.

It thus appears directly from this form of the Laplacian Equation how the Tesseral and Sectorial Harmonics arise.

1868. To expand any Function of μ and ϕ , say $F(\mu, \phi)$, in a Series of Laplace's Functions.

We have seen when p is any quantity between ± 1 , that with the definition $(1-2ph+h^2)^{-\frac{1}{2}} \equiv 1 + P_1 h + P_2 h^2 + \dots$, we have $1+3P_1+5P_2+\dots+(2n+1)P_n+\dots=0$ except where $p=1$, when the sum becomes ∞ . Let p stand for the cosine of the angle between the direction μ, ϕ and a fixed direction μ', ϕ' , so that $p = \mu\mu' + \sqrt{1-\mu^2}\sqrt{1-\mu'^2}\cos(\phi-\phi')$, and consider the integral $\iint (1+3P_1+5P_2+\dots)F(\mu, \phi) d\mu d\phi$.

If we integrate over any closed region S on the sphere, which is not cut by the direction μ', ϕ' , this result is evidently zero. If the integration extends over the whole surface of the sphere, the direction μ', ϕ' must be included; but no part of the integration contributes anything to the result except that

included in a very small contour about the direction μ', ϕ' , and in this direction $F(\mu, \phi)$ becomes $F(\mu', \phi')$. Hence the value of this double integral is $F(\mu', \phi') \iint (1+3P_1+5P_2+\dots) d\mu d\phi$, taken over the infinitesimally small area within the small

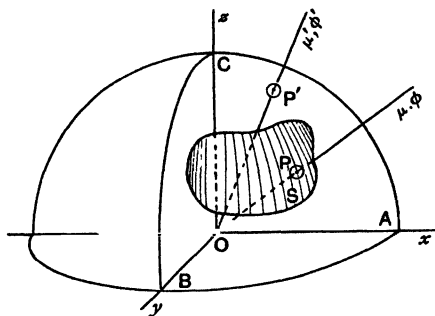

Fig. 608.

contour just enclosing μ', ϕ' . But as $1+3P_1+5P_2+\dots$ vanishes at all other points of the sphere, this is equal to

$$F(\mu', \phi') \iint (1+3P_1+5P_2+\dots) d\mu d\phi,$$

taken over the whole sphere, $=4\pi F(\mu', \phi')$, by Art. 1857;

$$\therefore F(\mu', \phi') = \frac{1}{4\pi} \sum_0^{\infty} (2n+1) \iint F(\mu, \phi) P_n d\mu d\phi.$$

When the integrations are effected each term is a function of μ', ϕ' , which enter through the P functions alone, and each term will satisfy Laplace's Equation and be a Laplace's Function.

This proof is due to O'Brien.

When $F(\mu, \phi)$ is itself a Laplace's Function, say Y_n , we have

$$4\pi Y_n' = \sum_0^{\infty} (2r+1) \iint Y_n P_r d\mu d\phi,$$

where Y_n' represents the value of Y_n along the axis of the functions, *i.e.* when $\mu = \mu'$ and $\phi = \phi'$; and every term vanishes except that for which $r=n$, whence

$$\int_{-1}^1 \int_0^{2\pi} Y_n P_n d\mu d\phi = \frac{4\pi Y_n'}{2n+1}.$$

1869. **The Value of the above Integral may be readily deduced by Physical Considerations.**

Take a layer of matter of surface density $\sigma = Y_n$ on the surface of the sphere (radius a). The potential at any internal point C at distance r from the centre and R from the element dS ,

$$V = \int \frac{\sigma dS}{R} = \int \frac{\sigma dS}{(a^2 - 2ar \cos \theta + r^2)^{\frac{1}{2}}} = \int Y_n \frac{1}{a} (P_0 + P_1 \frac{r}{a} + P_2 \frac{r^2}{a^2} + \dots) dS,$$

i.e. $V_i = \int Y_n P_n \frac{r^n}{a^{n+1}} dS.$

Similarly, at an external point,

$$V_e = \int Y_n \frac{1}{r} (P_0 + P_1 \frac{a}{r} + P_2 \frac{a^2}{r^2} + \dots) dS,$$

i.e. $V_e = \int Y_n P_n \frac{a^n}{r^{n+1}} dS.$

But, by Green's Theorem,

$$\left(-\frac{\partial V_e}{\partial r}\right)_{r=a} - \left(-\frac{\partial V_i}{\partial r}\right)_{r=a} = 4\pi\sigma_A$$

at any point A of the surface.

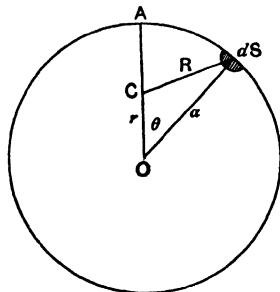

Fig. 609.

$\therefore \frac{2n+1}{a^2} \int Y_n P_n dS = 4\pi Y_n'$, and $dS = a^2 d\omega$, where $d\omega$ is the elementary solid angle subtended by dS at the centre.

Hence
$$\int Y_n P_n d\omega = \frac{4\pi Y_n'}{2n+1}.$$

1870. **Lemma.**

If $u \equiv p+1, v \equiv p-1$ and $D \equiv \frac{d}{dp}$, we may show, by applying Leibnitz' Theorem and comparing the r^s non-vanishing terms on each side, that

$$u^s v^s D^{n+s} u^n v^n / (n+s)! = D^{n-s} u^n v^n / (n-s)!; \text{ i.e. that if } z \equiv (p^2 - 1),$$

$$z^{\frac{s}{2}} D^{n+s_2^n} / (n+s)! = z^{-\frac{s}{2}} D^{n-s_2^n} / (n-s)!.$$

Hence
$$\int_{-1}^1 z^s (D^{n+s_2^n})^2 dp$$

$$= \int_{-1}^1 z^{\frac{s}{2}} D^{n+s_2^n} \cdot z^{-\frac{s}{2}} D^{n-s_2^n} dp \cdot \frac{(n+s)!}{(n-s)!}$$

$$= \frac{(n+s)!}{(n-s)!} \int_{-1}^1 D^{n+s_2^n} \cdot D^{n-s_2^n} dp, \text{ and integrating by parts,}$$

$$= \frac{(n+s)!}{(n-s)!} (-1)^s \int_{-1}^1 (D^n z^n)^2 dp$$

$$= \frac{(n+s)!}{(n-s)!} (-1)^s (2^n \cdot n!)^2 \int_{-1}^1 P_n^2 dp = \frac{(n+s)!}{(n-s)!} (-1)^s (2^n \cdot n!)^2 \cdot \frac{2}{2n+1}.$$

1871. **Integral of Product of Two Harmonics over Unit Sphere.**

If Y_n, Z_n be two Spherical Harmonics each of degree n , viz.

$$A_0 K_0 + \sum_1^n (A_s \cos s\phi + B_s \sin s\phi) K_s$$

and
$$a_0 K_0 + \sum_1^n (a_s \cos s\phi + b_s \sin s\phi) K_s,$$

where $K_s = (1-p^2)^{\frac{s}{2}} P_n^{(s)}$ (Art. 1867), we have, upon integrating the product with regard to ϕ from 0 to 2π ,

$$\int_0^{2\pi} Y_n Z_n d\phi = 2\pi A_0 a_0 K_0^2 + \pi \sum_1^n (A_s a_s + B_s b_s) K_s^2,$$

and integrating this with regard to p from -1 to 1 , we have

by the Lemma
$$\int_{-1}^1 \int_0^{2\pi} Y_n Z_n dp d\phi$$

$$= 2\pi A_0 a_0 \frac{2}{2n+1} + \sum_1^n (A_s a_s + B_s b_s) \frac{(n+s)!}{(n-s)!} \cdot \frac{2\pi}{2n+1}$$

$$= \frac{2\pi}{2n+1} \left\{ 2A_0 a_0 + \sum_1^n \frac{(n+s)!}{(n-s)!} (A_s a_s + B_s b_s) \right\}.$$

In the case when the harmonics are of different orders,

viz. n and m ,
$$\int_{-1}^1 \int_0^{2\pi} Y_n Z_m dp d\phi = 0,$$
 by Art. 1783.

If the harmonics be identical, i.e. $Z_n \equiv Y_n$, we have

$$\int_{-1}^1 \int_0^{2\pi} Y_n^2 dp d\phi = \frac{2\pi}{2n+1} \left\{ 2A_0^2 + \sum_1^n \frac{(n+s)!}{(n-s)!} (A_s^2 + B_s^2) \right\}.$$

1872. If any function of μ, ϕ , say $V \equiv F(\mu, \phi)$, be expanded in a series of Laplace's Functions as $V = Y_0 + Y_1 + Y_2 + Y_3 + \dots$, which is true upon the surface of the sphere $r = a$, then at points within the sphere we shall have

$$V_i = Y_0 + Y_1 \frac{r}{a} + Y_2 \frac{r^2}{a^2} + \dots,$$

and at points without

$$V_e = Y_0 \frac{a}{r} + Y_1 \frac{a^2}{r^2} + Y_2 \frac{a^3}{r^3} + \dots$$

For each term is a spherical harmonic satisfying Laplace's Equation and satisfying the conditions at the surface, and the latter vanishes at ∞ ; and there is but one value of V which does so.

Thus, when V is given all over the sphere, we can write down its value at any internal or any external point.

1873. Differentiation of the Zonal Harmonics

$$Z_n \equiv P_n r^n, \quad Z_{-n} \equiv \frac{P_{n-1}}{r^n}.$$

With cylindrical coordinates (ρ, ϕ, z) ,

$$r = \sqrt{z^2 + \rho^2}, \quad \mu = \cos \theta = z/\sqrt{z^2 + \rho^2},$$

$$\frac{\partial r}{\partial z} = \frac{z}{\sqrt{z^2 + \rho^2}} = \mu, \quad \frac{\partial \mu}{\partial z} = \frac{1 - \mu^2}{r}, \quad \frac{\partial r}{\partial \rho} = \sqrt{1 - \mu^2}, \quad \frac{\partial \mu}{\partial \rho} = -\frac{\mu\sqrt{1 - \mu^2}}{r}.$$

$$\text{Then } \frac{\partial}{\partial z} \equiv \mu \frac{\partial}{\partial r} + \frac{1 - \mu^2}{r} \frac{\partial}{\partial \mu}; \quad \frac{\partial}{\partial \rho} = \sqrt{1 - \mu^2} \left(\frac{\partial}{\partial r} - \frac{\mu}{r} \frac{\partial}{\partial \mu} \right);$$

$$\left. \begin{aligned} \frac{\partial Z_n}{\partial z} &\equiv \left\{ \mu n P_n + (1 - \mu^2) \frac{dP_n}{d\mu} \right\} r^{n-1} = n r^{n-1} P_{n-1} = n Z_{n-1}, \quad (\text{Art. 1844}), \\ \frac{\partial Z_{-n}}{\partial z} &\equiv \left\{ -\mu n P_{n-1} + (1 - \mu^2) \frac{dP_{n-1}}{d\mu} \right\} r^{-n-1} = -n r^{-n-1} P_n = -n Z_{-n-1}. \end{aligned} \right\} \quad (\text{A})$$

Therefore, whether i be positive or negative, $\frac{\partial Z_i}{\partial z} = i Z_{i-1}$, a rule analogous to the differentiation of a power. It follows that

$$\frac{\partial^2 Z_i}{\partial z^2} = i(i-1) Z_{i-2}, \quad \dots \quad \frac{\partial^r Z_i}{\partial z^r} = i(i-1) \dots (i-r+1) Z_{i-r}.$$

Again, by Arts. 1843, 1845,

$$\left. \begin{aligned} \frac{\partial Z_n}{\partial \rho} &= \sqrt{1 - \mu^2} r^{n-1} \left(n P_n - \mu \frac{dP_n}{d\mu} \right) = -\sqrt{1 - \mu^2} r^{n-1} \frac{dP_{n-1}}{d\mu}, \\ \frac{\partial Z_{-n}}{\partial \rho} &= -\sqrt{1 - \mu^2} r^{-n-1} \left\{ n P_{n-1} + \mu \frac{dP_{n-1}}{d\mu} \right\} = -\sqrt{1 - \mu^2} r^{-n-1} \frac{dP_n}{d\mu}. \end{aligned} \right\} \quad \dots (\text{B})$$

1874. Change of Origin of Zonal Harmonics to a New Origin O' on the same Axis Oz .

Let n be a positive integer. Taking O as the origin and Oz as the axis of the Zonal Harmonics, Z_n is a function of ρ and z alone, $=f(\rho, z)$. Then taking O' at the point $(0, 0, -a)$, the new ordinate z' of any point P , whose coordinates are x, y, z with regard to axes with origin O , is when referred to parallel

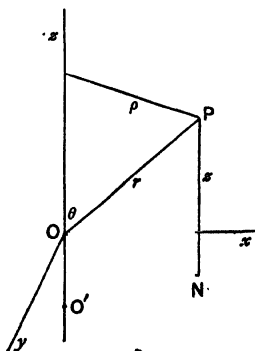

Fig. 810.

axes with origin O' , $z+a$, and the corresponding Zonal Harmonic Z_n' is denoted by $f(\rho, z')$, i.e. $f(\rho, z+a)$; and this being of degree n in z , we have

$$Z_n' = f + a \frac{\partial f}{\partial z} + \frac{a^2}{2!} \frac{\partial^2 f}{\partial z^2} + \dots + \frac{a^n}{n!} \frac{\partial^n f}{\partial z^n},$$

the accent denoting the Zonal Harmonic of degree n with reference to the new origin. That is,

$$\begin{aligned} Z_n' &= Z_n + a \frac{\partial Z_n}{\partial z} + \frac{a^2}{2!} \frac{\partial^2 Z_n}{\partial z^2} + \dots + \frac{a^n}{n!} \frac{\partial^n Z_n}{\partial z^n} \\ &= Z_n + naZ_{n-1} + \frac{n(n-1)}{1 \cdot 2} a^2 Z_{n-2} + \dots + na^{n-1} Z_1 + a^n. \end{aligned}$$

Similarly, if the Zonal Harmonic be of negative order, Z_{-n} and $r > a$, we have a series in ascending powers $\frac{a}{r}$ but extending to ∞ . For, as before, Z_{-n} is of form $F(\rho, z)$,

$$\begin{aligned} Z_{-n}' &= F(\rho, z+a) \equiv F + a \frac{\partial F}{\partial z} + \frac{a^2}{2!} \frac{\partial^2 F}{\partial z^2} + \dots \\ &= Z_{-n} - \frac{n}{1} a Z_{-n-1} + \frac{n(n+1)}{1 \cdot 2} a^2 Z_{-n-2} - \frac{n(n+1)(n+2)}{1 \cdot 2 \cdot 3} Z_{-n-3} + \dots \end{aligned}$$

But in cases where r , being measured from the first origin, is $< a$, this expansion is inadmissible. We then have

$$\begin{aligned} Z_{-1}' &= \{x^2 + y^2 + (z+a)^2\}^{-\frac{1}{2}} = (a^2 + 2ar \cos \theta + r^2)^{-\frac{1}{2}} \\ &= \frac{1}{a} \left(P_0 - P_1 \frac{r}{a} + P_2 \frac{r^2}{a^2} - \dots \right) \\ &= \frac{1}{a} \left(Z_0 - \frac{Z_1}{a} + \frac{Z_2}{a^2} - \frac{Z_3}{a^3} + \dots \right). \end{aligned}$$

Differentiating with regard to z , i.e. with regard to $z+a$ on the left side,

$$\begin{aligned} \frac{\partial Z_{-1}'}{\partial z} &= -\frac{1}{a^2} \left(Z_0 - \frac{2Z_1}{a} + \frac{3Z_2}{a^2} - \frac{4Z_3}{a^3} + \dots \right), \\ \text{i.e. } 1 \cdot Z_{-2}' &= \frac{1}{a^2} \left(1 \cdot Z_0 - 2 \frac{Z_1}{a} + 3 \frac{Z_2}{a^2} - 4 \frac{Z_3}{a^3} + \dots \right). \end{aligned}$$

Differentiating again,

$$1 \cdot 2 Z_{-3}' = \frac{1}{a^3} \left(1 \cdot 2 Z_0 - 2 \cdot 3 \frac{Z_1}{a} + 3 \cdot 4 \frac{Z_2}{a^2} - \dots \right), \text{ etc.,}$$

and thus, by continued differentiations, we arrive at

$$Z_{-n}' = \frac{1}{a^n} \left[1 - \frac{n}{1} \frac{Z_1}{a} + \frac{n(n+1)}{1 \cdot 2} \frac{Z_2}{a^2} - \frac{n(n+1)(n+2)}{1 \cdot 2 \cdot 3} \frac{Z_3}{a^3} + \dots \right].$$

PROBLEMS.

1. Show that $Ax^3 + By^3 + Cz^3 - \frac{3}{2}(x^2 + y^2 + z^2)(Ax + By + Cz)$ is a spherical harmonic, and that the corresponding surface harmonic on unit sphere is

$$(A \cos^3 \phi + B \sin^3 \phi) \sin^3 \theta + C \cos^3 \theta - \frac{3}{2}(A \cos \phi + B \sin \phi) \sin \theta - \frac{3}{2} C \cos \theta.$$

2. If OA, OB, OC be three perpendicular axes cutting a unit sphere with centre O at A, B, C , and if P be any other point on the surface, show that $\cos PA \cos PB \cos PC$ is a surface harmonic.

3. ABC is a fixed quadrantal triangle on unit sphere, and a point P moves on the surface, so that

$$V \equiv a \cos^2 PA + b \cos^2 PB + c \cos^2 PC + 2f \cos PB \cos PC \\ + 2g \cos PC \cos PA + 2h \cos PA \cos PB$$

is a surface harmonic. Show that the cone $V=0$ has three perpendicular generators.

4. If P_n be Legendre's coefficient of order n , show that

$$\int_{-1}^1 P_1 P_n (5P_2 - 3) dp = 0,$$

unless $n=3$, in which case the value is $6/7$.

5. Show that

$$\int_{-1}^1 (P_0 \sqrt{1} + P_1 \sqrt{3} + P_2 \sqrt{5} + \dots + P_n \sqrt{2n+1})^2 dp = 2(n+1).$$

6. Show that $\int_{-1}^1 p^4 P_n dp = 0$, except in the cases

$$\int_{-1}^1 p^4 P_0 dp = \frac{2}{3}, \quad \int_{-1}^1 p^4 P_2 dp = \frac{8}{33}, \quad \int_{-1}^1 p^4 P_4 dp = \frac{16}{315}.$$

7. Show that $\int_{-1}^1 p^5 P_n dp = 0$, except in the cases

$$\int_{-1}^1 p^5 P_1 dp = \frac{1}{7}, \quad \int_{-1}^1 p^5 P_3 dp = \frac{8}{33}, \quad \int_{-1}^1 p^5 P_5 dp = \frac{16}{315}.$$

8. Show that the area of one of the larger loops of the curve $r = aP_2$ is $\frac{a^2}{32} \left(5\sqrt{2} + 11 \cos^{-1} \frac{1}{\sqrt{3}} \right)$.

9. Show that if ϵ be very small, the area of the nearly circular figure $r = a(1 + \epsilon P_2)$ is approximately $\pi a^2 (1 + \frac{1}{2} \epsilon)$.

10. Show that if ϵ be very small, the volume of the nearly spherical surface $r = a(1 + \epsilon P_2)$ is very approximately $\frac{4}{3} \pi a^3 (1 + \frac{3}{8} \epsilon^2)$.

11. Show that if $R^2 = 1 - 2ax + a^2$, $R'^2 = 1 - 2\beta x + x^2$,

$$\int_{-1}^1 \frac{dx}{RR'} = \frac{2}{\sqrt{a\beta}} \tanh^{-1} \sqrt{a\beta},$$

and deduce the values of

$$\int_{-1}^1 P_m P_n dp, \quad m \neq n, \quad \text{and} \quad \int_{-1}^1 P_n^2 dp.$$

12. Show that

$$\frac{\sin 3\theta}{\sin \theta} = \frac{1}{3} + \frac{8}{3} P_2; \quad \frac{\sin 4\theta}{\sin \theta} = \frac{4}{5} P_1 + \frac{16}{5} P_3; \quad \frac{\sin 5\theta}{\sin \theta} = \frac{1}{5} + \frac{8}{7} P_2 + \frac{128}{35} P_4.$$

13. Give the rational integral function of the second degree of the three quantities, $\sin \lambda$, $\cos \lambda \sin \theta$, $\cos \lambda \cos \theta$, and put the terms of the second order under the form

$$c_1 \sin^2 \lambda + (c_2 \sin^2 \theta + c_3 \sin \theta \cos \theta + c_4 \cos^2 \theta) \cos^2 \lambda \\ + (c_5 \cos \theta + c_6 \sin \theta) \sin \lambda \cos \lambda,$$

and show that, with the addition of an arbitrary quantity c_0 , it becomes a Laplace's function if $3c_0 = -(c_1 + c_2 + c_3)$.

[SMITH'S PRIZE, 1876.]

14. For points x, y, z which lie on the sphere $x^2 + y^2 + z^2 = 1$, express Q as a series of surface harmonics, where

$$Q = x + 2y + 3z + 4x^2 + 5y^2 + 6z^2 + 7yz + 8zx + 9xy + 10x^3 + 11xyz.$$

15. Express $\sin^4 \theta$ in a series of Legendre's coefficients as

$$\sin^4 \theta = \frac{8}{15} P_0 - \frac{16}{21} P_2 + \frac{8}{35} P_4.$$

Why cannot $\sin^3 \theta$ be expanded in a finite series of spherical harmonics?

[MATH. TRIP., 1873.]

16. If $P_n = \frac{1}{2^n n!} \frac{d^n (\mu^2 - 1)^n}{d\mu^n}$, prove that if $\int P_n d\mu$ be taken to vanish when $\mu = 1$,

$$\int P_n d\mu = \frac{1}{n(n+1)} (\mu^2 - 1) \frac{dP_n}{d\mu}; \quad P_{n+1} = (2n+1) \int P_n d\mu + P_{n-1}.$$

Show how by the help of these formulae the numerical values of $P_1, P_2, P_3, \dots, P_n$, and those of their differential coefficients, may be conveniently found for any given value of μ .

[PROF. ADAMS, S.P., 1873.]

17. Prove that

$$\log \left(1 + \operatorname{cosec} \frac{\theta}{2} \right) = P_0 + \frac{1}{2} P_1 + \frac{1}{8} P_2 + \frac{1}{4} P_3 + \dots \quad [\text{COLL. EX.}]$$

18. Obtain a solution of the differential equation

$$\frac{d}{dx} \left(\sin x \frac{d}{dx} P_n \right) + n(n+1) \sin x P_n = 0$$

in the form of a series of cosines of multiples of x .

[MATH. TRIP. II., 1888.]

19. Show that if $(1 - 2ax + a^2)^{-\frac{k-1}{2}} = 1 + \sum_0^\infty Q_n a^n$, then will

$$(n+2)Q_{n+2} - (2n+k+1)xQ_{n+1} + (n+k-1)Q_n = 0.$$

[E. J. ROUTH, *Proc. L.M.S.*, xxvi.]

20. Prove that if

$$V \equiv (1 - 2ax + a^2)^{-\frac{1}{2}} = 1 + K_1 a + K_2 a^2 + \dots + K_n a^n + \dots,$$

$$(i) \quad x \frac{\partial V}{\partial x} - a \frac{\partial V}{\partial a} = 3a^2 V^{\frac{3}{2}};$$

$$(ii) \quad (1-x^2) \frac{\partial^2 V}{\partial x^2} + a^2 \frac{\partial^2 V}{\partial a^2} = 12a^2 V^{\frac{5}{2}};$$

$$(iii) \quad (1-x^2)K_n'' - 4xK_n' + n(n+3)K_n = 0;$$

$$(iv) \quad (n+1)K_{n+1} - (2n+3)xK_n + (n+2)K_{n-1} = 0;$$

$$(v) \quad K_n' = (2n+1)K_{n-1} + (2n-3)K_{n-3} + (2n-7)K_{n-5} + \dots$$

$$(vi) \quad (2n+3) \int K_n dx = K_{n+1} - K_{n-1} + \text{const.};$$

$$(vii) \quad K_{2n-1} = 3P_1 + 7P_3 + \dots + (4n-1)P_{2n-1},$$

$$K_{2n} = 1 + 5P_2 + 9P_4 + \dots + (4n+1)P_{2n}.$$

$$(viii) \quad \int_{-1}^1 K_m K_n dx = 0 \text{ or } (n+1)(n+2),$$

according as $m+n$ is odd, or even and $m \neq n$;

21. If $V = (1 - 2ap + a^2)^{-\frac{2m+1}{2}} = 1 + \sum Q_n a^n$, show that

$$Q_n = \frac{1}{1 \cdot 3 \dots (2m-1)} \left(\frac{d}{dp} \right)^m P_{m+n}.$$

22. If $V = (1 - 2ap + a^2)^{-\frac{2m+1}{2}} = 1 + \sum Q_n a^n$, prove that

$$(i) \quad \int_{-1}^1 Q_{2r} dp = 2 \frac{2m(2m+1) \dots (2m+2r-1)}{1 \cdot 2 \dots (2r+1)}; \quad (ii) \quad \int_{-1}^1 Q_{2r+1} dp = 0.$$

23. Show that the roots of

$$x^n - \frac{n}{1} \frac{n(n-1)}{2n(2n-1)} x^{n-2} + \frac{n(n-1)}{1 \cdot 2} \frac{n(n-1)(n-2)(n-3)}{2n(2n-1)(2n-2)(2n-3)} x^{n-4} - \dots = 0$$

are all real and unequal, and lie between 1 and -1.

24. Prove that one solution of Legendre's Equation

$$(1-x^2)y_2 - 2xy_1 + n(n+1)y = 0,$$

where n is a positive integer, is a polynomial of the n^{th} degree, and determine it.

25. Prove that a like statement is true of the equation

$$(1-x^2)y_2 + axy_1 + n(n-1-a)y = 0$$

unless $1+a-n$ be one of a series of numbers $n-2, n-4, n-6, \dots$ which terminate in 1 or 0, according as n is odd or even, and in that case a polynomial of degree $1+a-n$ is a solution.

[MATH. TRIP. II., 1918.]

26. $P_n(\mu)$ being the coefficient of h^n in $(1-2\mu h+h^2)^{-\frac{1}{2}}$ and m, n unequal, show that $\int_{-1}^1 \mu^2 P_n(\mu) P_m(\mu) d\mu$ is zero unless m and n differ from one another by 2, and that when $m=n+2$, its value is $2(n+1)(n+2)/(2n+1)(2n+3)(2n+5)$. [MATH. TRIP. II., 1916.]

If $m=n$, show that the value is

$$2(4n^3+6n^2-1)/(2n-1)(2n+1)^2(2n+3).$$

27. Prove that

$$(i) \int_{-1}^1 (1-x^2) P_m'(x) P_n'(x) dx = 0 \quad (n \neq m);$$

$$(ii) \int_{-1}^1 (1-x^2) \{P_n'(x)\}^2 dx = 2n(n+1)/(2n+1).$$

[MATH. TRIP. II., 1914.]

28. Prove that $P_{n+1} - P_{n-1} = (2n+1) \int_{-1}^p P_n dp = (2n+1) \int_1^p P_n dp$.

29. Prove that

$$(i) \int_0^\pi P_n(\cos \theta) d\theta = 0 \quad \text{or} \quad \pi \left\{ \frac{1 \cdot 3 \dots (n-1)}{2 \cdot 4 \dots n} \right\}^2 \quad \text{as } n \text{ is odd or even};$$

$$(ii) \int_0^\pi \cos \theta P_n(\cos \theta) d\theta = 0 \quad \text{or} \quad \frac{n\pi}{n+1} \left\{ \frac{1 \cdot 3 \dots (n-2)}{2 \cdot 4 \dots (n-1)} \right\}^2 \quad \text{as } n \text{ is even or odd}.$$

30. Show that

$$(i) (1-p^2)^{-\frac{1}{2}} = \frac{\pi}{2} \left\{ 1 + 5 \left(\frac{1}{2}\right)^2 P_2 + 9 \left(\frac{1 \cdot 3}{2 \cdot 4}\right)^2 P_4 + 13 \left(\frac{1 \cdot 3 \cdot 5}{2 \cdot 4 \cdot 6}\right)^2 P_6 + \dots \right\};$$

$$(ii) \frac{2}{\pi} = 1 - 5 \left(\frac{1}{2}\right)^3 + 9 \left(\frac{1 \cdot 3}{2 \cdot 4}\right)^3 - 13 \left(\frac{1 \cdot 3 \cdot 5}{2 \cdot 4 \cdot 6}\right)^3 + \dots;$$

$$(iii) \frac{p}{\sqrt{1-p^2}} = \frac{\pi}{2} \left\{ 3 \cdot \frac{1}{2} P_1 + 7 \left(\frac{1}{2}\right)^2 \cdot \frac{3}{4} P_3 + 11 \left(\frac{1 \cdot 3}{2 \cdot 4}\right)^2 \cdot \frac{25}{6} P_5 + \dots \right\}.$$

[Use formula of Art. 1813.]

[ORELLE, *Jour.* LVI.; TODHUNTER, *Functions*, p. 115.]

31. Show that $\frac{P_1^2 - P_0^2}{P_1'^2 - P_0'^2}, \frac{P_2^2 - P_1^2}{P_2'^2 - P_1'^2}, \frac{P_3^2 - P_2^2}{P_3'^2 - P_2'^2}, \frac{P_4^2 - P_3^2}{P_4'^2 - P_3'^2}$ are respectively equal to $(p^2 - 1)/1^2, (p^2 - 1)/2^2, (p^2 - 1)/3^2, (p^2 - 1)/4^2$, and that $P_2 = P_1$, when $p = -\frac{1}{3}$ or 1; $P_3 = P_2$, when $p = \frac{\pm\sqrt{6}-1}{5}$ or 1.

32. Prove that

$$P_0^2 + 3P_1^2 + 5P_2^2 + \dots + (2n+1)P_n^2 = (n+1)^2 P_n^2 - (p^2 - 1)P_n'^2.$$

[MATH. TRIP., 1888.]

33. Prove that

$$P_0'^2 + 3P_1'^2 + 5P_2'^2 + \dots + (2n+1)P_n'^2 = \frac{1}{3} \{ (n+2)^2 P_n'^2 - (p^2 - 1)P_n''^2 \}.$$

[MATH. TRIP., 1888.]

34. If $(1 - 2\alpha x + \alpha^2)^{-\frac{2l+1}{2}} = 1 + Z_1\alpha + Z_2\alpha^2 + \dots + Z_n\alpha^n + \dots$, l being a positive integer, show that, accents denoting differentiations with regard to x ,

- (i) $\int_{-1}^1 Z_m Z_n dx = 0$ if $m+n$ be odd;
- (ii) $(1-x^2)Z_n'' - 2(l+1)xZ_n' + n(n+2l+1)Z_n = 0$;
- (iii) $Z_n' = \{2(n+l)-1\}Z_{n-1} + \{2(n+l)-5\}Z_{n-3} + \{2(n+l)-9\}Z_{n-5} + \dots$.

35. If $(1 - 2\alpha x + \alpha^2)^{-m} = \sum_{n=0}^{\infty} P_{m,n}\alpha^n$, show that

(i) $x \frac{d}{dx} P_{m,n} - \frac{d}{dx} P_{m,n-1} = n P_{m,n}$;

(ii) $(1-x^2) \frac{d^2 P_{m,n}}{dx^2} - (2m+1)x \frac{dP_{m,n}}{dx} + n(n+2m)P_{m,n} = 0$;

(iii) $\int_{-1}^1 (1-x^2)^{m-1} P_{m,n} P_{m,r} dx = 0, \quad r \neq n$;

(iv) $\int_{-1}^1 (1-x^2)^{m-1} P_{m,n}^2 dx = \frac{2^{2m-1}}{m+n} \frac{\Pi(n+2m-1)}{\Pi(n)} \left\{ \frac{\Pi(m-\frac{1}{2})}{\Pi(2m-1)} \right\}^2$.

36. Show that, if $k > 0$ and P_λ be the Legendrian coefficient of order λ ,

- (i) $\int_{-1}^1 (x^2 - 1)^k \frac{d^k P_m}{dx^k} \frac{d^k P_n}{dx^k} dx = 0$;
 - (ii) $\int_0^1 x^{p+1} P_{n+1} dx = \frac{p+1}{p+n+3} \int_0^1 x^p P_n dx$;
 - (iii) $\int_0^1 x^p P_{n+2} dx = \frac{p-n}{p+n+3} \int_0^1 x^p P_n dx$;
- } m and n being different positive integers, and p any positive quantity.
- [MATH. TRIP. II., 1889.]

37. Prove that $P_n(\sec \theta) = \frac{1}{\pi} \int_0^\pi \sec^n \theta (1 + \sin \theta \cos \chi)^n d\chi$.

38. If $P_n(\mu)$ denote Legendre's coefficient of degree n , show that $\int_{-1}^1 \mu(1-\mu^2) \frac{dP_n}{d\mu} \frac{dP_m}{d\mu} d\mu$ is zero unless $m \sim n$ be unity, and determine its value in these cases. [MATH. TRIP., 1896.]

39. Prove that

$$(x + \cos \phi \sqrt{x^2 - 1})^n = \frac{1}{2^{n-1} n!} \frac{d^n}{dx^n} (x^2 - 1)^n + \frac{1}{2^{n-1}} \sum_{m=1}^{n-1} \frac{(x^2 - 1)^{\frac{m}{2}}}{(n+m)!} \frac{d^{n+m} (x^2 - 1)^m}{dx^{n+m}} \cos m\phi$$

and deduce the formulae

$$(i) \frac{1}{(n-m)!} \frac{d^{n-m}}{dx^{n-m}} (x^2 - 1)^n = \frac{(x^2 - 1)^m}{(n+m)!} \frac{d^{n+m}}{dx^{n+m}} (x^2 - 1)^n;$$

$$(ii) P_n(x) = \frac{1}{\pi} \int_0^\pi (x + \cos \phi \sqrt{x^2 - 1})^n d\phi. \quad [\text{MATH. TRIP., 1887.}]$$

40. Denoting by $P_n(\mu)$ the Legendrian coefficient of order n , prove that if $m < n$,

$$\int_{-1}^1 \frac{d^m P_m}{d\mu^m} \frac{d^n P_n}{d\mu^n} d\mu = \frac{(n-1)n(n+1)(n+2)}{24} \{3m(m+1) - n(n+1) + 6\},$$

if $m+n$ be even, but zero if $m+n$ be odd. [MATH. TRIP., 1897.]

41. Prove that if n be a positive integer $(\sinh^2 x \frac{d}{dx})^n \operatorname{cosech}^{2n} x$ is equal to

$$(-1)^n 2^n n! \coth^n x \left\{ 1 + \frac{n(n-1)}{2^2} \operatorname{sech}^2 x + \frac{n(n-1)(n-2)(n-3)}{2^2 \cdot 4^2} \operatorname{sech}^4 x + \dots \right\},$$

and that either expression satisfies the differential equation

$$\sinh^2 x \frac{d^2 y}{dx^2} = n(n+1)y. \quad [\text{MATH. TRIP., 1897.}]$$

42. Prove that

$$\frac{\pi}{\sqrt{2}} P_n(\cos \theta) = \int_0^\theta \frac{\cos n\phi \cos \frac{\phi}{2}}{\sqrt{\cos \phi - \cos \theta}} d\phi + \int_\theta^\pi \frac{\cos n\phi \sin \frac{\phi}{2}}{\sqrt{\cos \theta - \cos \phi}} d\phi,$$

except when $n=0$, when the right side $= \pi \sqrt{2} P_0(\cos \theta)$.

[DIRICHLET; TODHUNTER, *Functions of Laplace*, p. 35.]

43. Show that if the usual polar variables θ, ϕ be replaced by x, y defined by $\cot \frac{\theta}{2} \cdot e^\phi = x, \tan \frac{\theta}{2} \cdot e^\phi = -y$, the surface harmonic of order n satisfies the equation $\frac{\partial^2 V}{\partial x \partial y} + \frac{n(n+1)}{(x-y)^2} V = 0$.

If V be any solution of this equation, verify that

$$\frac{\partial V}{\partial x} + \frac{\partial V}{\partial y}, \quad x \frac{\partial V}{\partial x} + y \frac{\partial V}{\partial y}, \quad x^2 \frac{\partial V}{\partial x} + y^2 \frac{\partial V}{\partial y}$$

are also solutions.

[MATH. TRIP. II., 1889.]

44. X_n' is the solid Zonal Harmonic of positive order n , having the axis of z for its axis and the origin of coordinates for its origin; X_m is the solid Zonal Harmonic of positive order m , having the same axis, and a point distant a from the origin for its origin; prove that

$$X_n' = X_n + naX_{n-1} + \frac{n(n-1)}{1 \cdot 2} a^2 X_{n-2} + \dots + na^{n-1} X_1 + a^n.$$

The corresponding Zonal Harmonic of negative order being denoted by Y_n' , prove that for points included within any sphere whose radius is less than a , and whose centre is the new origin,

$$Y_n' = \frac{1}{a^{n+1}} \left[1 - \frac{(n+1)!}{n!} \frac{X_1}{a} + \frac{(n+2)!}{2!n!} \frac{X_2}{a^2} - \frac{(n+3)!}{3!n!} \frac{X_3}{a^3} + \dots \right].$$

Obtain the expression for Y_n' for points outside any sphere whose radius is greater than a , and whose centre is the new origin in the form

$$Y_n' = Y_n - \frac{(n+1)!}{n!} a Y_{n+1} + \frac{(n+2)!}{2!n!} a^2 Y_{n+2} - \frac{(n+3)!}{3!n!} a^3 Y_{n+3} + \dots$$

[MATH. TRIP., 1885.]

45. Prove that the series

$$\frac{1}{2} P_1 + \sum_{i=1}^{\infty} (-1)^i (4i+1) \frac{1 \cdot 3 \cdot 5 \dots (2i-3)}{2 \cdot 4 \cdot 6 \dots (2i+2)} P_{2i}$$

is equal to $-\mu$ for all values of μ from -1 to 0 , and to μ for all values of μ from 0 to 1 . Apply this formula to calculate the potential of a hemispherical shell whose surface density varies as the density from a diametral plane at an external or internal point.

[MATH. TRIP., 1878.]

46. Show that the surface

$$r = a \left[\frac{1}{2} + \frac{1}{2} \frac{5P_2}{1 \cdot 4} - \frac{1 \cdot 3}{2 \cdot 4} \frac{9P_4}{3 \cdot 6} + \frac{1 \cdot 3 \cdot 5}{2 \cdot 4 \cdot 6} \frac{13P_6}{5 \cdot 8} - \dots \right]$$

consists of two equal spheres which touch each other at the origin.

[MATH. TRIP., 1884.]

47. If $x = \operatorname{sn} x + A_3 \operatorname{sn}^3 x + A_5 \operatorname{sn}^5 x + A_7 \operatorname{sn}^7 x + \dots$, show that

$$(2n+1)A_{2n+1} = k^n + \frac{(n+1)n}{2^2} k^{n-1}(1-k)^2 + \frac{(n+2)(n+1)(n)(n-1)}{2^2 \cdot 4^2} k^{n-2}(1-k)^4 + \text{etc.}$$

$$= \frac{2}{\pi} \int_0^K \{dn(u, k')\}^{2n+1} du. \quad [\text{MATH. TRIP. III., 1886.}]$$

48. Prove that if $\rho^2 = x^2 + y^2$ and $r^2 = \rho^2 + z^2$, then U_i being the solid Zonal Harmonic of degree i , and P_i the corresponding Legendre's coefficient,

$$\frac{\partial^2}{\partial \rho^2} U_{i+2} = r^i [P'_{i-1} - (i^2 + i + 1)P_i],$$

and

$$\frac{\partial^2}{\partial \rho^2} \frac{U_{i-2}}{r^{2i-3}} = r^{-i-1} [P'_{i-1} - i(i-1)P_i],$$

where accents denote differentiations with regard to the cosine of the co-latitude, giving

$$r^{i+1} \frac{\partial^2 (U_{i-2}/r^{2i-3})}{\partial \rho^2} - r^{-i} \frac{\partial^2}{\partial \rho^2} U_{i+2} = (2i+1)P_i.$$

49. If $\rho = x^2 + y^2$ and V_i be the solid Zonal Harmonic of degree i , show that

$$\frac{1}{r^{2i+1}} \frac{\partial^2 V_{i+2}}{\partial \rho^2} = \frac{\partial^2}{\partial \rho^2} \frac{V_{i-2}}{r^{2i-3}},$$

where $r^2 = x^2 + y^2 + z^2$.

[MATH. TRIP., 1890.]

50. Show that

$$(n-m+1) \frac{d^m P_{n+1}}{d\mu^m} = (2n+1)\mu \frac{d^m P_n}{d\mu^m} - (n+m) \frac{d^m P_{n-1}}{d\mu^m}. \quad [\text{S.P., 1875.}]$$

51. Find the number of independent solutions of the equations $u_{xx} + u_{yy} + u_{zz} = 0$, $xu_x + yu_y + zu_z = nu$, and prove that if u be a solution, $u(x^2 + y^2 + z^2)^{-\frac{1}{2}(2n-1)}$ also will satisfy the first equation.

Prove that if

$\alpha + \beta\omega + \gamma\omega^2 = f(x + y\omega + z\omega^2)$ and $A + B\omega + C\omega^2 = \phi(\alpha + \beta\omega + \gamma\omega^2)$, where ω is one of the primitive cube roots of unity, then $\alpha - \beta$, $\beta - \gamma$, $\gamma - \alpha$, $A - B$, $B - C$, $C - A$ will all be spherical harmonics.

[MATH. TRIP., 1876.]

52. Prove that the function which has the value $+1$ on the Northern hemisphere and -1 on the Southern is given in Zonal Harmonics by the series $\sum C_{2n+1} P_{2n+1}$, where

$$C_{2n+1} = (-1)^n \left\{ \frac{1 \cdot 3 \cdot 5 \dots (2n-1)}{2 \cdot 4 \cdot 6 \dots 2n} + \frac{1 \cdot 3 \cdot 5 \dots (2n+1)}{2 \cdot 4 \cdot 6 \dots (2n+2)} \right\}.$$

Hence find a function which has the values $A+B$, $A-B$ on (i) the Northern and Southern, (ii) the Eastern and Western, (iii) any two corresponding hemispheres, respectively, the axis of the Earth being permanently the axis of the harmonics.

[MATH. TRIP., 1884.]

53. The polar equation of a nearly spherical surface is $r = a + bP_n$, where P_n is a zonal harmonic of the n^{th} degree, and b is a small quantity whose powers above the second may be neglected. Show

that the area of the surface exceeds the area of a sphere of radius a by $2\pi b^2(n^2 + n + 2)/(2n + 1)$. [MATH. TRIP., 1878.]

54. In the nearly spherical surface $r = a + bP_n$, where P_n is a zonal harmonic and b is small, prove that at any point the excess of the measure of curvature above $1/a^2$ is to a first approximation

$$\frac{b}{a^3}(n^2 + n - 2)P_n. \quad [\text{MATH. TRIP. III., 1886.}]$$

55. Show that the Legendre's function Q_n of the second kind (Art. 1821) may be expressed in the form

$$Q_n = P_n \tanh^{-1} p - \left\{ \frac{2n-1}{1 \cdot n} P_{n-1} + \frac{2n-5}{3(n-1)} P_{n-3} + \frac{2n-9}{5(n-2)} P_{n-5} + \dots \right\},$$

and that the general solution of John Ivory's Equation,

$$\frac{d}{dp} \left\{ (1-p^2)^{s+1} \frac{d^{s+1}z}{dp^{s+1}} \right\} + \{n(n+1) - s(s+1)\} (1-p^2)^s \frac{d^s z}{dp^s} = 0,$$

is given by $\frac{d^s z}{dp^s} = AP_n^{(s)} + BQ_n^{(s)}$; and further that Q_n may be expressed as $Q_n = C \left(\frac{d}{dp} \right)^{-(n+1)} (1-p^2)^{-(n+1)}$, a form corresponding to that of Rodrigues for P_n , C being a constant.

56. Find the integral of the square of a tesseral harmonic over the surface of the unit sphere.

If the general expression for a tesseral harmonic be of the form $A(1-\mu^2)^{\frac{m}{2}} \mathfrak{Y}_n^{(m)} \cos m\phi$, where the coefficient of the highest power of μ in $\mathfrak{Y}_n^{(m)}$ is unity, prove that

$$\mathfrak{Y}_{n+1}^{(m)} = \mu \mathfrak{Y}_n^{(m)} - \frac{n^2 - m^2}{4n^2 - 1} \mathfrak{Y}_{n-1}^{(m)}. \quad [\text{MATH. TRIP.}]$$

CHAPTER XL.

SUPPLEMENTARY NOTES.

NOTE A. DEFINITION OF INTEGRATION. RIEMANN.

1875. The definition of the integral $\int_a^b \phi(x) dx$, given in Art. 11, for the case where $\phi(x)$ is single-valued, finite and continuous for the range $a \rightarrow b$, is an analytical expression of Newton's Second Lemma. It is pointed out in Art. 13 that the several subintervals h_1, h_2, h_3, \dots of the range $a-b$ need not be taken as equal so long as it is understood that the greatest of them is ultimately taken as indefinitely small; and Cauchy adopted this modification as the basis of his investigations (see Art. 1266). But in dividing the range $a-b$ into an infinite number of subdivisions,

$$\delta_1 \equiv x_1 - a, \quad \delta_2 \equiv x_2 - x_1, \quad \dots \quad \delta_n \equiv b - x_{n-1},$$

the definition has still kept to the idea that each of these intervals is to be multiplied by the value of $\phi(x)$ at the beginning or at the end of the interval, that the sum of such products is to be formed, and then, if such sum has an existent limit and converges to a definite quantity, that limit is defined as $\int_a^b \phi(x) dx$. And it has been seen in Chapter V. how Cauchy proposed to exclude from the definition any element or elements in which $\phi(x)$ becomes infinite or discontinuous.

For the class of functions met with in elementary analysis and with which this treatise has been mainly concerned, this treatment will suffice, and has been adopted as offering an adequate scope for the beginner, with fewest difficulties in the initial conception of the processes to be followed.

But it is evident that the multipliers of the several subdivisions need not have been taken as the values of $\phi(x)$ at either end of the interval, but might equally well have been taken as any of its values intermediate between the greatest and least values which $\phi(x)$ is capable of assuming in each interval.

1876. Starting with this idea, Riemann in a memoir (*Ueber die Darstellbarkeit einer Function durch eine Trigonometrische Reihe*) has given a definition of integration which does not require that the function considered shall be continuous in the interval $a \rightarrow b$. Let a and b be two finite quantities between which a real variable x ranges. Let $\phi(x)$ be a function of x which remains finite, but not necessarily continuous in the interval. Take d a definite given small positive quantity, which is called the Norm, of any mode of division of the interval $a-b$ into sub-elements or segments $\delta_1, \delta_2, \dots \delta_n$, viz. $\delta_1 = x_1 - a, \delta_2 = x_2 - x_1, \dots \delta_n = b - x_{n-1}$, each of these elements being not greater than the norm d of that mode of division. Then evidently there is an infinite number of modes of division corresponding to any particular norm d , and each of these is also a possible mode of division for any greater norm. Let $\epsilon_1, \epsilon_2, \dots \epsilon_n$ be positive proper fractions, and let S stand for $\sum_1^n \delta_r f(x_{r-1} + \epsilon_r \delta_r)$. Then, if S converges to a definite limit whatever mode of division be chosen and whatever the fractions $\epsilon_1, \epsilon_2, \dots \epsilon_n$ may be when the norm d is made to diminish indefinitely, this limit is represented by $\int_a^b f(x) dx$, and the function is said to admit of integration for the range $a \rightarrow b$. (See Prof. H. J. S. Smith, *Proc. Lond. Math. Soc.*, vi., p. 140.)

1877. A formal proof of the convergence of the series S under certain conditions is given by Riemann, and amended by Prof. Smith in one or two particulars in which Riemann's demonstration is wanting in formal accuracy. The values of $\phi(x)$, corresponding to the values of x for any segment, are called the "ordinates" of the segment. The difference between the greatest and least ordinates of a segment is termed the "ordinate difference" or the "oscillation" of $\phi(x)$ for that

segment. Let D_1, D_2, \dots, D_n be the oscillations in the several segments. Then the greatest and least values of S for any particular mode of division are respectively attained by taking the greatest and least ordinates of the several segments, and the difference of these sums, viz. θ , is given by $\theta = \sum_1^n \delta_r D_r$. But for any definite norm d the greatest and least values of S do not in general result from the same mode of subdivision. Therefore the difference Θ between the greatest and least values of S for all modes of division corresponding to a given norm d will in general be greater than θ , which is the difference for a particular mode of division. And to be sure of the convergency of S it will be necessary to show that Θ in any case diminishes without limit when d diminishes without limit.

1878. Professor Smith enunciates Riemann's Theorem as follows:

Let σ be any given quantity, however small. Then, if in every division of norm d the sum of the segments for which the oscillations surpass σ diminishes without limit when d diminishes without limit, the function admits of integration, and conversely.

Let $G(d)$ and $L(d)$ be the greatest and least values of S corresponding to a given norm d , not necessarily arising from the same system of subdivisions for that norm.

Then taking any two norms d_1 and d_2 ($d_1 > d_2$), since every mode of division for norm d_2 is one for norm d_1 , we have $G(d_1) \leq G(d_2)$ and $L(d_1) \geq L(d_2)$. Moreover, for every norm d_1 another norm d_2 can always be found which is less than d_1 , such that $G(d_1) > G(d_2)$ and $L(d_1) < L(d_2)$, unless the max. and min. ordinates of the several segments are the same throughout the interval, however small the segments may be taken, in which case $G(d)$ and $L(d)$ are respectively $h_1(b-a)$ and $h_2(b-a)$, where h_1 and h_2 are the greatest and least ordinates common to all the segments. And therefore, except in this case, a series of norms d_1, d_2, d_3, \dots of decreasing magnitude can be found so that $G(d_1), G(d_2), G(d_3), \dots$ forms a decreasing series, and $L(d_1), L(d_2), L(d_3), \dots$ an increasing one.

And $G(d_1) > L(d_2)$, except in the case where the function can be represented by a series of segments of lines parallel to

the x -axis, when we may have $G(d_1) = L(d_2)$. For if the two systems of division which respectively furnish $G(d_1)$ and $L(d_2)$ be superimposed, then to find the value of $G(d)$ for the new system of division, each resulting segment will have to be multiplied either by the same ordinate which multiplied it before or by a still greater one from a neighbouring segment; and to find the value of $L(d)$ for the new system, each segment must be multiplied either by the same ordinate which multiplied it before or by a still smaller ordinate from a neighbouring segment. So that the least value of S obtainable by taking the greatest ordinate for each segment in any mode of division whatever is not less than the greatest value of S obtainable in any division whatever by taking the least ordinate of each segment.

If then, for any given norm d , $L'(d)$ be the least value of S for the mode of division which yields $G(d)$, and $G'(d)$ be the greatest value of S for the mode of division which yields $L(d)$,

$$G(d) > G'(d); \quad G'(d) \geq L'(d) \quad \text{and} \quad L(d) < L'(d);$$

$$\begin{aligned} \therefore G(d) - L(d) &= [G(d) - L'(d)] + [G'(d) - L(d)] - [G'(d) - L'(d)] \\ &\succ [G(d) - L'(d)] + [G'(d) - L(d)]. \end{aligned}$$

But if s_1 be the sum of the segments which in the division $\{G(d), L'(d)\}$ have oscillations $> \sigma$, s_2 the sum of the segments which in the division $\{G'(d), L(d)\}$ have oscillations $> \sigma$, and Ω be the greatest oscillation for any division of norm d , which is by supposition finite; then

$$\begin{aligned} G(d) - L'(d) &= \text{contribution from } s_1 \\ &\quad + \text{contribution from } (b - a - s_1) \\ &\succ s_1 \Omega + \sigma(b - a - s_1) \end{aligned}$$

$$\text{and} \quad G'(d) - L(d) \succ s_2 \Omega + \sigma(b - a - s_2);$$

$$\therefore \text{adding, } G(d) - L(d) \succ (s_1 + s_2)(\Omega - \sigma) + 2\sigma(b - a),$$

and therefore, as σ is as small as we please and d can be taken so small that $s_1 + s_2$ is as small as we please, $G(d) - L(d)$, that is Θ , diminishes without limit as d diminishes without limit and $f(x)$ admits of integration for the range a to b .

1879. Conversely, if $f(x)$ admits of integration in the interval a to b , S converges to a definite limit, and Θ diminishes indefinitely as d is made indefinitely small, and therefore also

each of the differences θ must do the same. But if s be the sum of the segments in which the oscillations exceed σ in any mode of division, we have $\sigma s \succ \theta$. And however small σ may have been taken, we can, by taking d small enough, make θ/σ less than any assignable quantity, however small. Hence if S converges to a definite limit, s must also diminish without limit as d is indefinitely decreased.*

1880. Prof. Smith (*loc. cit.*) points out also that Riemann's criterion of integrability is applicable in the case of any multiple integral extended over a finite region.

1881. It is incidentally assumed that the interval $a-b$ is one which extends from a given value of x , viz. $x=a$, to a greater one, $x=b$, and the interval $a-b$ has been divided into subsections x_1-a , x_2-x_1 , x_3-x_2 , etc. If we reverse the order of the array of points a , x_1 , x_2 , ... x_{n-1} , b , the only difference in the argument will be that the sign of each of the partial products formed in constructing the maximum and minimum values of S has been changed; the new sums formed for the reversed order do not differ in absolute value from the values before considered, but are of opposite sign. It therefore follows that

$$\int_b^a f(x)dx = -\int_a^b f(x)dx.$$

1882. Moreover, if we add to the array several other points of division $x=c_1$, $x=c_2$, ... $x=c_{n-1}$, the maximum and minimum values of S have not been respectively increased and decreased, for the norm of the mode of division with the additional points in the array cannot have been increased by their introduction. But the sums corresponding to the maximum and minimum values of S for the several intervals a to c_1 , c_1 to c_2 , etc., are respectively

$$\lessdot \text{ and } \gtrdot \int_a^{c_1} f(x)dx, \int_{c_1}^{c_2} f(x)dx, \text{ etc.,}$$

and modes of division of these intervals can be found for which their maxima and minima differ from these respective quantities by less than any assignable quantities, however small. Also the aggregate of any of these modes of division

* *Proc. Lond. Math. Soc.*, vi, p. 143.

of these partial intervals forms a mode of division of the whole interval $a-b$. Hence $\int_a^b f(x)dx$ must be equal to the sum of the integrals $\int_a^{c_1} f(x)dx, \int_{c_1}^{c_2} f(x)dx, \dots, \int_{c_{n-1}}^b f(x)dx$.

1883. In the same way other general propositions such as those of Chapter IX. may be reconsidered for Riemann's generalised definition.

NOTE B. CONVERGENCE OF AN INTEGRAL.

1884. An infinite integral is one in which either of the limits is $+\infty$ or $-\infty$, or in which the integration extends from $-\infty$ to $+\infty$. In what follows we shall assume that a is a positive quantity, *i.e.* $a > 0$, and that $f(x)$ is a finite function of x for all values of x from a given value $x=a$ to another value $x=b$ which is greater than a , and that $f(x)$ is integrable in this range.

The integral $\int_a^x f(z) dz$ is defined as the limit, supposing such limit to exist, when x becomes infinitely large, of the integral $I \equiv \int_a^x f(z) dz$. If such limit be finite the integral is said to converge to that limit. If there be no finite limit to the increase in the value of I as x tends to $+\infty$, then, according as I tends to $\pm\infty$, the integral is said to diverge to $\pm\infty$. Integrals in which the integrand changes sign periodically in the march of x from a to ∞ , such as

$$\int_a^{\infty} \sin x dx \quad \text{or} \quad \int_a^{\infty} x^2 \sin (bx+c) dx,$$

are said to oscillate, and such oscillations may be either finite or infinite by virtue of the growth of the multiplier of the factor of the integrand which causes the changes of sign during the march of x .

1885. If $f(x)$ be a function which changes sign during the march of x , the integral $\int_a^{\infty} f(z) dz$ is said to be absolutely convergent when $\int_a^{\infty} |f(z)| dz$ is convergent. But such an integral may be convergent even when not absolutely convergent.

The integral $\int_{-\infty}^{\infty} f(z) dz$ is defined as the sum of the integrals $\int_{-\infty}^c f(z) dz$ and $\int_c^{\infty} f(z) dz$, where c is a finite constant, and is said to be convergent when each of these integrals is convergent. Moreover, this definition is independent of the particular value of c . For, let c and c' be two values of x on the range of its values, $c' > c$.

$$\text{Then } \int_x^{\infty} f(z) dz = \int_x^c f(z) dz + \int_c^{\infty} f(z) dz \quad (x < c)$$

$$\text{and } \int_c^x f(z) dz = \int_c^{\infty} f(z) dz + \int_c^x f(z) dz \quad (x > c').$$

Hence, as $\int_c^{\infty} f(z) dz$ and $\int_c^x f(z) dz$ are finite, $\int_x^{\infty} f(z) dz$ and $\int_c^x f(z) dz$ are both convergent or both divergent as $x \rightarrow -\infty$ and $\int_c^x f(z) dz$ and $\int_c^{\infty} f(z) dz$ are both convergent or both divergent as $x \rightarrow \infty$.

Therefore, supposing $\int_{-\infty}^c f(z) dz$ and $\int_c^{\infty} f(z) dz$ to be both convergent integrals, we have

$$\int_{-\infty}^c f(z) dz + \int_c^{\infty} f(z) dz = \int_{-\infty}^{\infty} f(z) dz + \int_c^{\infty} f(z) dz,$$

which establishes the independence of the definition with respect to the particular value of c used.

1886. If $f_1(x)$, $f_2(x)$ be two positive finite functions of x , both integrable for the range a to b , $b > a > 0$, and such that $f_2(x) \succ f_1(x)$ for all values of x for that range, then, when b becomes infinitely large, $\int_a^{\infty} f_2(z) dz$ is convergent if $\int_a^{\infty} f_1(z) dz$ be convergent. And if $f_2(x) \prec f_1(x)$ for all values of x from a to b , then, when b becomes infinitely large, $\int_a^{\infty} f_2(z) dz$ is divergent if $\int_a^{\infty} f_1(z) dz$ be divergent.

In many cases comparison with a known convergent or divergent integral will suffice to determine the convergency or divergency of an integral.

For example, if $a > 0$, $\int_a^\infty \frac{dz}{z^n}$ is convergent or divergent according as n is $>$ or $\nabla 1$.

Hence $\int_a^\infty \frac{dx}{x^2\sqrt{a^2+x^2}} < \int_a^\infty \frac{dx}{x^3}$ and is convergent, whilst

$$\int_b^\infty \frac{x^{\frac{3}{2}} dx}{\sqrt{x^4-a^4}} > \int_b^\infty \frac{dx}{\sqrt{x}}$$

and is divergent ($b > a$).

1887. If then an index n can be assigned which is > 1 , and for which $x^n f(x)$ is finite for all values of x from $x=a$ to $x=\infty$, where $a > 0$, it will follow that $|x^n f(x)|$ does not exceed some finite positive limit λ , and therefore that

$$\int_a^\infty |f(z)| dz \nabla \lambda \int_a^\infty \frac{dz}{z^n}, \quad \text{i.e. } \nabla \frac{\lambda}{n-1} \frac{1}{a^{n-1}},$$

and is therefore convergent. Hence in such case $\int_a^\infty f(z) dz$ is absolutely convergent.

But if an index n can be assigned which is $\nabla 1$, and for which $x^n f(x)$ is never less than some finite positive limit λ (excluding zero) for all values of x from a to ∞ , ($a > 0$), or if it becomes infinitely large when x increases indefinitely, it will follow that

$$\int_a^\infty f(x) dx \nless \lambda \int_a^\infty \frac{dx}{x^n}, \quad \text{i.e. } \nless \frac{\lambda}{1-n} \left[x^{1-n} \right]_a^\infty \text{ or } \nless \lambda \left[\log x \right]_a^\infty,$$

and therefore in either case becomes positively infinite, and the integral diverges to $+\infty$.

And if an index n can be assigned which is $\nabla 1$ for which $x^n f(x)$ is negative, and its numerical value is never less than some finite limit λ (excluding zero) for all values of x from a to ∞ , ($a > 0$), it will follow that $\int_a^\infty f(x) dx$ diverges to $-\infty$.

It appears therefore that under the conditions specified as to the integrability of $f(x)$, and as to its remaining finite for the range of integration, a to ∞ , where $a > 1$, if n can be assigned > 1 , such that a finite limit of $x^n f(x)$ exists when x becomes infinitely great, then $\int_a^\infty f(z) dz$ is convergent; and if n can be assigned $\nabla 1$, such that $x^n f(x)$ does not become zero when x is increased indefinitely, but whether it approaches

a finite limit or becomes either positively or negatively infinite, the integral $\int_a^\infty f(z)dz$ is divergent.

For instance the integrals $I_1 \equiv \int_a^\infty \frac{x^2}{x^4+a^4} dx$; $I_2 \equiv \int_a^\infty \frac{x^3}{x^4+a^4} dx$ are respectively convergent and divergent, for the indices 2 and 1 can be assigned for these respective cases for which

$$\lim_{x \rightarrow \infty} x^2 \frac{x^2}{x^4+a^4} = 1 \quad \text{and} \quad \lim_{x \rightarrow \infty} x \frac{x^3}{x^4+a^4} = 1,$$

and is finite in each case.

1888. Again the integral $\int_a^\infty \frac{\sin \theta}{\theta} d\theta$ is convergent, a being positive and > 0 . For by Art. 340,

$$\begin{aligned} \int_a^b \frac{\sin \theta}{\theta} d\theta &= \frac{1}{a} \int_a^\xi \sin \theta d\theta + \frac{1}{b} \int_\xi^b \sin \theta d\theta, \quad a < \xi < b, \\ &= \frac{1}{a} (\cos a - \cos \xi) + \frac{1}{b} (\cos \xi - \cos b), \end{aligned}$$

which for any values of a, ξ, b cannot be greater than $\frac{2}{a} + \frac{2}{b}$, and, when b increases without limit, cannot be $> \frac{2}{a}$. Similarly $\int_a^\infty \frac{\cos \theta}{1+\theta^2} d\theta$ is convergent.

Also these integrals taken from 0 to a are obviously both finite. Hence the integrals from 0 to ∞ are finite. Their values have been found in Arts. 994, 1048.

1889. For other tests for Convergency, the reader may refer to Prof. Carslaw's *Fourier's Series*, pages 98-121.

NOTE C. STANDARD FORMS.

1890. In such standard integrals as those of Arts. 44, 71, etc., viz. $\int \frac{dz}{\sqrt{a^2-z^2}}$, $\int \frac{dz}{\sqrt{z^2+a^2}}$, etc., which it is usual to give simply as $\sin^{-1} \frac{x}{a}$, $\sinh^{-1} \frac{x}{a}$, etc., it is to be noted that the left-hand members are even functions of a , whilst the right-hand members are odd functions of a . To be strictly accurate, such results should be written as $\sin^{-1} \frac{x}{|a|}$, $\sinh^{-1} \frac{x}{|a|}$, etc., where $|a|$ is the positive numerical value of $\sqrt{a^2}$, and where the inverse function is understood to have its principal value. Similarly

$$\int \frac{dz}{\sqrt{z^2-a^2}} = \log \frac{z + \sqrt{z^2-a^2}}{|a|}.$$

For in such cases the integral does not change its sign with a . And for exactness there must be a corresponding understanding as to all deduced results. In the same way in any other of the integrals discussed, and in which a constant is to be found with an even index in the integrand, and with an odd one in the result of integration a corresponding modification is to be understood; *e.g.* in the integral $\int_0^\infty \frac{\log(1+a^2z^2)}{1+b^2z^2} dz$,

Art. 1044, the result of which is usually written as $\frac{\pi}{b} \log \frac{a+b}{b}$, but which is itself manifestly unaltered by a change of sign of a or of b , the value should strictly be written as

$$\frac{\pi}{|b|} \log \frac{|a|+|b|}{|b|}.$$

And similarly in any like case.

NOTE D. RATIONAL FRACTIONAL FORMS. HERMITE'S PROCESS.

1891. In the integration of rational algebraic fractional forms, viz. $f(z)/\phi(z)$ (Chap. V.), where f and ϕ are polynomials, rational as regards z , it has been assumed that the factorisation of $\phi(z)$ could be effected. This depends upon the possibility of solving $\phi(z)=0$.

It is a well-known fact, established by Abel and Wantzel, that it is impossible to solve algebraically the *general* equation of degree higher than the fourth. Hermite has given a solution of the quintic by aid of Elliptic Integrals (Burnside and Panton, *Th. Eq.*, p. 435). In consequence, the integration of such algebraic fractional forms as involve an unfactorisable denominator of the fifth or higher degree can only be completely performed for special forms of the numerator. But in any case, as we know that the equation $\phi(x)=0$ does possess as many roots as indicated by its degree, although there may be no means of discovering them, we are entitled to assert that the integral of $f(x)/\phi(x)$ does in every case consist of two portions, the one a rational algebraic function, and the other the sum of a set of simple logarithms with

constant coefficients in which such pairs of terms as involve complementary imaginary roots may combine to form real terms by aid of the inverse symbols \tan^{-1} or \tanh^{-1} .

1892. It has been shown by Hermite that the algebraic portion of such integrals can be always found, whether $\phi(x)$ be factorisable or not, and in cases where no logarithmic portion is present, or if the residual numerator happens to be a constant multiple of $\phi'(x)$ the whole integration can be effected. But in the general case no means of discovery of the Logarithmic portion is available for the reason stated.

An examination of the ordinary process for obtaining the H.C.F. of two polynomials in x , A and B , will disclose the fact that each of the successive "remainders" is of the form $\lambda A + \mu B$, where λ and μ are themselves polynomial expressions, and that when A and B are prime to each other the final remainder which is then merely numerical is also of the same form. It follows therefore that it is always possible in such case to find two polynomials λ and μ such that $\lambda A + \mu B$ is independent of x , and therefore also to find two polynomials λ' and μ' such that $\lambda' A + \mu' B = C$, where C is any given third polynomial in x . Moreover, supposing the degrees of A and B in x to be respectively the p^{th} and q^{th} , and that of C to be not more than $p+q-1$, we may note that it may be assumed that the degrees of λ' and μ' do not exceed the $(q-1)^{\text{th}}$ and $(p-1)^{\text{th}}$ respectively. For if we take their degrees to be greater than $q-1$ and $p-1$, we could by division write $\lambda' = \lambda'' B + \lambda'''$, $\mu' = \mu'' A + \mu'''$, where λ'' , λ''' , μ'' , μ''' are other polynomials such that the degrees of λ''' , μ''' do not respectively exceed $q-1$ and $p-1$, and thus $(\lambda'' + \mu'')AB + \lambda'''A + \mu'''B = C$, and by equating coefficients of terms of higher degree than the highest in C , *i.e.* of the $(p+q)^{\text{th}}$, $(p+q+1)^{\text{th}}$, etc., degrees, it will appear that $\lambda'' + \mu''$ must vanish identically.

1893. In the discussion of the integration of $f(x)/\phi(x)$, where $\phi(x)$ is unfactorisable, we may assume

(1) That $\phi(x)$ contains no repeated factor; otherwise the H.C.F. process upon $\phi(x)$ and $\phi'(x)$ would disclose that factor.

(2) That $f(x)$ is of lower degree than $\phi(x)$, by Art. 140, and that in this case the result is purely logarithmic.

(3) But if $\phi(x)$ be itself the square of an irreducible polynomial u , and $f(x)$ of lower degree than u , we may find polynomials λ and μ such that

$$f(x) = \lambda \frac{du}{dx} + \mu u,$$

$$\text{i.e. } \int \frac{f(x)}{\phi(x)} dx = \int \frac{\lambda}{u^2} \frac{du}{dx} dx + \int \frac{\mu}{u} dx = -\frac{\lambda}{u} + \int \frac{\mu + \frac{d\lambda}{dx}}{u} dx;$$

and supposing u of degree p , $\frac{du}{dx}$ is of degree $p-1$, so that λ and μ are of respective degrees $\geq p-1$ and $p-2$, so that $\mu + \frac{d\lambda}{dx}$ is of lower degree than u , and therefore the unintegrated portion is entirely logarithmic, but vanishing if $\mu + \frac{d\lambda}{dx}$ vanishes.

(4) If $\phi(x)$ be the r^{th} power of an irreducible polynomial u , we may find λ and μ such that $f(x) = \lambda \frac{du}{dx} + \mu u^{r-1}$, and then

$$\int \frac{f(x)}{\phi(x)} dx = \int \frac{\lambda}{u^r} \frac{du}{dx} dx + \int \frac{\mu}{u} dx = -\frac{1}{r-1} \frac{\lambda}{u^{r-1}} + \frac{1}{r-1} \int \frac{\frac{d\lambda}{dx}}{u^{r-1}} dx + \int \frac{\mu}{u} dx,$$

in which the index of the u in the integrand has been lowered by unity; and by repetitions of this process we may obtain a result in which the only unintegrated part is of the form

$$\int \frac{\chi(x)}{u} dx.$$

(5) If $\phi(x)$ be the product of positive integral powers of such irreducible factors, say $\phi(x) = u_1^{\alpha} u_2^{\beta} u_3^{\gamma} \dots$, the separate prime factors $u_1, u_2 \dots$ may be discovered by the usual process employed in finding the H.C.F. for $\phi(x)$ and its differential coefficients, and thus, supposing $\alpha < \beta < \gamma \dots$, if we determine λ and μ so that $\lambda_1 u_1^{\alpha} u_2^{\beta} u_3^{\gamma} \dots + \mu u_1^{\alpha} \equiv f(x)$, we can write $f(x)/\phi(x)$

in the form $\frac{\lambda_1}{u_1^{\alpha}} + \frac{\mu}{u_2^{\beta} u_3^{\gamma} \dots}$, and repetitions of the process will

separate out the fraction $\frac{f(x)}{\phi(x)}$ into the form $\frac{\lambda_1}{u_1^{\alpha}} + \frac{\lambda_2}{u_2^{\beta}} + \frac{\lambda_3}{u_3^{\gamma}} + \dots$,

to each of which portions we can apply the foregoing rules.

Hence in all cases the algebraic portion of $\int \frac{f(x)}{\phi(x)} dx$ can be discovered.

Ex. To integrate $I = \int \frac{2+x+5x^4+2x^5+5x^6}{(1+x+x^5)^2} dx$.

Here $I = \int \frac{(1+x+x^5)(-3+5x^4)+4x+5}{(1+x+x^5)^2} dx$, and finding λ, μ such that $\lambda(1+5x^4)+\mu(1+x+x^5) \equiv 5+4x$, we may take λ of degree 4, μ of degree 3, and

$$(a_0+a_1x+a_2x^2+a_3x^3+a_4x^4)(1+5x^4) + (b_0+b_1x+b_2x^2+b_3x^3)(1+x+x^5) \equiv 5+4x,$$

giving $a_1 = -1, b_0 = 5$ and the rest zero, whence

$$-x(1+5x^4)+5(1+x+x^5) = 5+4x,$$

and $I = \int \frac{(1+x+x^5)(-3+5x^4)-x(1+5x^4)+5(1+x+x^5)}{(1+x+x^5)^2} dx$

$$= \int \frac{5x^4+2}{1+x+x^5} dx - \int x \frac{1+5x^4}{(1+x+x^5)^2} dx$$

$$= \int \frac{5x^4+2}{1+x+x^5} dx + \frac{x}{1+x+x^5} - \int \frac{dx}{1+x+x^5} = \frac{x}{1+x+x^5} + \log(1+x+x^5).$$

The same process will be helpful even in simple cases.

E.g. (i) $I = \int \frac{dx}{(x^2+1)^2}$. Writing $(a_0+a_1x)2x+b_0(x^2+1) \equiv 1$, we have

$$a_0=0, \quad a_1 = -\frac{1}{2}, \quad b_0=1;$$

$$I = \int \frac{(-\frac{1}{2}x)2x+(x^2+1)}{(x^2+1)^2} dx = \frac{x}{2} \frac{1}{x^2+1} + \frac{1}{2} \int \frac{dx}{x^2+1} = \frac{x}{2(x^2+1)} + \frac{1}{2} \tan^{-1}x.$$

(ii) $I = \int \frac{2x^3-1}{(x^3+x+1)^2} dx$. Writing

$$(a_0+a_1x)(1+x+x^3)+(b_0+b_1x+b_2x^2)(1+3x^2) \equiv -1+2x^3,$$

we have

$$a_1=b_0=b_2=0, \quad a_0=-1, \quad b_1=1;$$

$$\therefore I = \int \frac{-(x^3+x+1)+x(3x^2+1)}{(x^3+x+1)^2} dx = -\frac{x}{x^3+x+1}.$$

NOTE E. LEGENDRE'S SUBSTITUTION APPLIED TO FUNCTIONS OF FORM $1/X\sqrt{Y}$.

1894. With regard to integrals of the form $I \equiv \int \frac{Mx+N}{X\sqrt{Y}} dx$,

where $X = a_1x^2+2b_1x+c_1$, $Y = a_2x^2+2b_2x+c_2$ discussed in Art. 291 onwards, in which we have adopted the substitution

$y = \frac{Y}{X}$, it should be mentioned that Greenhill in his "Chapter on the Integral Calculus" generally prefers to put $y^2 = \frac{Y}{X}$.

This of course alters the character of the substitution-graphs, making them symmetrical about the x -axis. (See Ex. 56, p. 323.)

Vol. I.) An alternative substitution is mentioned by Mr. Hardy as being followed by Stolz (*Grundzüge der Diff. und Int.-rechnung*) and by Dr. I'A. Bromwich, viz. to use the same substitution as that of Legendre in the reduction of an Elliptic Integral to Standard form, viz. $x = \frac{\lambda\xi + \mu}{\xi + 1}$, whereby X takes the form

$$\{(a_1\lambda^2 + c_1)\xi^2 + 2(a_1\lambda\mu + b_1\lambda + \mu + c_1)\xi + (a_1\mu^2 + c_1)\}/(\xi + 1)^2$$

and Y takes a similar form with suffixes 2. Then, if λ, μ be so chosen that

$$a_1\lambda\mu + b_1(\lambda + \mu) + c_1 = 0, \quad a_2\lambda\mu + b_2(\lambda + \mu) + c_2 = 0 \quad (\text{cf. Art. 1463})$$

I is reduced to the form

$$A \int \frac{\xi d\xi}{(a\xi^2 + b)\sqrt{a'\xi^2 + b'}} + B \int \frac{d\xi}{(a\xi^2 + b)\sqrt{a'\xi^2 + b'}}$$

where A, B, a, b, a', b' are certain constants. And now we may proceed either as in Art. 310, or use the substitutions $u\sqrt{a'\xi^2 + b'} = 1$ in the first; $v\sqrt{a'\xi^2 + b'} = \xi$ in the second, which reduce each integral to the form $\int \frac{dv}{Pv^2 + Q}$. This method fails if $\frac{a_1}{a_2} = \frac{b_1}{b_2}$. But we may then put $a_1x + b_1 = \xi$ and proceed as in Art. 309.

NOTE F. CONTINUITY, DOUBLE LIMITS, DIFFERENTIATION OF AN INTEGRAL, ETC.

1895. Continuity of a Function of two real Independent Variables.

Let $z = f(x, y)$ be a single-valued function of two independent real variables x and y which may be regarded as fixing a definite point. Construct a small rectangle with centre at $x; y$ and with corners $x \pm \xi, y \pm \eta$. Then if θ_1, θ_2 be positive proper fractions and finite values of ξ, η can be found for which the value of $f(x \pm \theta_1\xi, y \pm \theta_2\eta) - f(x, y)$ taken positively is determinate and less than any arbitrarily chosen positive quantity ϵ , however small, for all combinations of the quantities θ_1, θ_2 , the function is said to be continuous at the point x, y and throughout any region of the $x-y$ plane for each point of which the same test is satisfied.

1896. In the case of such a function as the above, viz. $z=f(x, y)$, it may happen that in evaluating the value of z for a point for which $x=x_0$ and $y=y_0$, the mode of approach of x, y to the limiting position x_0, y_0 is not immaterial. That is $Lt_{x \rightarrow x_0} Lt_{y \rightarrow y_0} f(x, y)$ may not be the same thing as

$$Lt_{y \rightarrow y_0} Lt_{x \rightarrow x_0} f(x, y).$$

Take for instance the case of Sir R. Ball's *Cylindroid*, viz. the surface $z = \frac{2axy}{x^2 + y^2}$. At any point for which $x=x_0, y=y_0$ other than those which lie on the z -axis, the value of z is $\frac{2ax_0y_0}{x_0^2 + y_0^2}$, and is not dependent upon the direction in which x, y approaches its limiting position. But for points on the z -axis putting $y=mx$ so that the direction of approach is defined as being in a definite direction, $z = \frac{2am}{1+m^2}$, and as m changes from 0 to 1, z changes from 0 to a , so that if the direction of approach to the point for which $x=0, y=0$ be unassigned, the value of z cannot be assigned, and there is discontinuity in that its value is not independent of the relative mode of approach of x and y to their ultimately zero values. As a matter of fact, the z -axis is a nodal line upon the *cylindroid*.

1897. In partial differentiation of a function of two independent variables, $z=f(x, y)$, which is itself single-valued, finite and continuous for all values of x and y which lie within specified limits, the value of the fraction $\frac{f(x, y + \delta y) - f(x, y)}{\delta y}$ will in general approach a definite limit when δy becomes indefinitely small for each value of x within the specified range. The limit is then denoted by $\frac{\partial}{\partial y} f(x, y)$. But it is possible that within this range of values of x there may be one or more values of x for which no such limit exists. In such case the operation of differentiation fails and is an illegitimate process. Take the case $f(x, y) = x \sin xy$. Here

$$\frac{f(x, y + \delta y) - f(x, y)}{\delta y} = \frac{x \sin x(y + \delta y) - x \sin xy}{\delta y},$$

and for all finite values of x and y this tends uniformly to the limit $x^2 \cos xy$ when δy is indefinitely diminished.

But if x be increased indefinitely, the limit when $\delta y = 0$ of

$$\frac{x \sin x(y + \delta y) - x \sin xy}{\delta y} - x^2 \cos xy$$

does not vanish, but may assume any value we please, however great. Therefore, for instance, the second differentiation suggested in Ex. 37, p. 381, Vol. I., would be an illegitimate operation.

But in the case $u = \int_0^{\infty} x^r e^{-ax} dx$, where r is a positive integer and a is real and positive, $\frac{\delta u}{\delta a} = \int_0^{\infty} x^r e^{-ax} \frac{e^{-x\delta a} - 1}{\delta a} dx$, and whether x be zero, finite or infinitely large, $x^r e^{-ax} \frac{e^{-x\delta a} - 1}{\delta a}$ tends uniformly to the limiting form $-x^{r+1} e^{-ax}$, vanishing whether $x=0$ or $x=\infty$. Hence the differentiations employed in Ex. 3 p. 369, Vol. I., are legitimate although the range of x is infinite. Similar remarks apply to Arts. 1039, 1041, 1046, etc., as therein noted.

1898. If discontinuity in such a function as $z = f(x, y)$ exists for any values of x, y , the equation $\frac{\partial^2 z}{\partial x \partial y} = \frac{\partial^2 z}{\partial y \partial x}$ is not necessarily true for such points. This equation holds for any point x, y if a small rectangle whose centre is x, y can be constructed in the plane of $x-y$ within which each of the differentiations is a possible operation, i.e. provided there be no discontinuity in the function or in either of its differential coefficients.

$$\text{The rule } \frac{\partial}{\partial c} \int \phi(x, c) dx = \int \frac{\partial}{\partial c} \phi(x, c) dx \quad (\text{Art. 354}) \dots\dots\dots (1)$$

is virtually a consequence of

$$\frac{\partial^2 z}{\partial x \partial c} = \frac{\partial^2 z}{\partial c \partial x} \dots\dots\dots (2)$$

For $\psi(x, c) = \int \phi(x, c) dx$ is only another way of writing $\phi(x, c) = \frac{\partial \psi(x, c)}{\partial x}$; whence $\frac{\partial \phi}{\partial c} = \frac{\partial^2 \psi}{\partial c \partial x}$. And the assertion of rule (1) is that

$$\frac{\partial}{\partial c} \psi(x, c) = \int \frac{\partial}{\partial c} \phi(x, c) dx, \text{ which is the same as } \frac{\partial}{\partial x} \frac{\partial \psi}{\partial c} = \frac{\partial \phi}{\partial c}.$$

Hence the assertion (1) is equivalent to the assertion (2); and therefore, where the one rule fails, the other breaks down also.

1899. In all multiple integral evaluations and theorems, such for instance as that of Art. 361, viz.

$$\int_{c_0}^c \int_a^b \phi(x, y) dx dy = \int_a^b \int_{c_0}^c \phi(x, y) dy dx,$$

it is assumed that the subject of integration remains finite and continuous for all points within and at the boundaries of the region over which the integration is conducted; and moreover that the differentials which we integrate do not become infinite or discontinuous at any point within the range of the integration at each step of the process. If this be not the case, anomalies and contradictions may arise such as that noted in Ex. 38, p. 381, Vol. I.

NOTE G. UNIFORM CONVERGENCE.

1900. After the investigations of Stokes (*Trans. Camb. Phil. Soc.*, viii. 1847) and Seidel (*Abh. d. Bayerischen Akad.*, 1848), some time elapsed before writers on the General Theory of Functions realised fully the importance of careful distinction between the uniform and non-uniform convergence of infinite series. The question of uniformity of convergence is a fundamental point in this General Theory, and it always arises when we have under consideration the limiting value of a function depending upon more than one independent variable. For a very useful discussion of the Convergence of Infinite Series and Products, we may refer to Chrystal's *Algebra*, vol. ii., pages 113-185. Reference may also be made to Dr. Hobson's *Trigonometry*, ch. xiv., or Harkness and Morley, *Th. of F.*, ch. iii.

1901. Consider any series $u_1 + u_2 + u_3 + \dots + u_n + \dots$, in which each term is a single-valued finite and continuous function of a variable z , which may be complex, and lying within a given region Γ in the Argand diagram, and of the integral number n which signifies its position in the series; then, if for every positive value of ϵ , however small we can assign a positive integer ν independent of z , such that for all values of n

greater than ν , the modulus of the residue of the series beyond the term u_n is less than ϵ , the series is said to be uniformly convergent for all points within that region (Chrystal, *Alg.*, ii., p. 144). If $\sum u_n$ converges uniformly within the aforesaid region to a definite value $\phi(z)$, then $\phi(z)$ is itself a continuous function of z for all points within the region. That is at each point z_0 within the region Γ , writing $u_r \equiv f(z, r)$,

$$\phi(z_0) = \lim_{z \rightarrow z_0} \sum_1^{\infty} f(z, r) = \sum_1^{\infty} \lim_{z \rightarrow z_0} f(z, r) = \sum_1^{\infty} f(z_0, r).$$

(See references above.)

1902. With the definition of an integral as in Art. 1266, viz. $\lim_{n \rightarrow \infty} \sum_1^n (z_r - z_{r-1}) \omega_{r-1}$, and supposing that each of the ω 's is a single-valued finite and continuous function of z and a complex constant a , which both lie in a definite region Γ of the Argand diagram, say $\omega_r = f_r(a, z)$, and that when a and z are made to approach indefinitely near definitely assigned points a_0 and z_0 lying within the region Γ , the function $f_r(a, z)$ tends uniformly to the value $f_r(a_0, z_0)$ and is continuous, then we shall have

$$\lim_{a \rightarrow a_0} \lim_{n \rightarrow \infty} \sum_1^n (z_r - z_{r-1}) \omega_{r-1} = \lim_{n \rightarrow \infty} \sum_1^n (z_r - z_{r-1}) \lim_{a \rightarrow a_0} \omega_{r-1},$$

i.e.
$$\lim_{a \rightarrow a_0} \int f(a, z) dz = \int \lim_{a \rightarrow a_0} f(a, z) dz = \int f(a_0, z) dz.$$

This result, for the case when z and a are real, has been assumed in Art. 354.

NOTE H. UNICURSAL CURVES.

1903. In any case of a rational integral function of x and y , say $\phi(x, y)$, in which the real variables x, y are connected by a rational integral algebraic equation $F(x, y) = 0$ whose graph is a curve of deficiency zero, and therefore unicursal, both x and y are expressible as rational algebraic functions of a third variable t , as also $\frac{dx}{dt}$, and therefore in all such cases the integration $\int \phi(x, y) dx$ can be effected with the limitation mentioned in Note D, and the result is partly rational and

partly a logarithmic transcendent of form $\sum A \log(x-a)$, where A and a are certain constants.

1904. The principal elementary cases of unicursal curves are (a) the conic, (b) the nodal cubic, (c) the three-node quartic.

(a) The equation of a conic may be written as $u_1v_1=w_1$, where u_1, v_1, w_1 are linear functions of x and y . Putting $u_1=\lambda w_1, v_1=\lambda^{-1}$ and solving, we may express both x and y as rational algebraic functions of λ .

(b) The equation of a nodal cubic may be written $u_1v_1=w_3$, where u_1, v_1 are linear homogeneous functions of x and y , and w_3 is homogeneous and of degree 3. Putting $y=\lambda x$, we can express both x and y as rational algebraic functions of λ .

(c) The general equation of a three-node quartic may be written in homogeneous coordinates (say areals) as

$$ax^2+by^2+cz^2+2fy^{-1}z^{-1}+2gz^{-1}x^{-1}+2hx^{-1}y^{-1}=0,$$

and therefore, taking another point x', y', z' connected with x, y, z by the relations $x/x^{-1}=y/y^{-1}=z/z^{-1}$, we have

$$ax'^2+by'^2+cz'^2+2fy'z'+2gz'x'+2hx'y'=0,$$

i.e. the three-node quartic may be regarded as the "inverse" of a conic, using the term "inversion" in the sense in which it is employed by Dr. Salmon, *H. Pl. Curves*, p. 244.

Now x', y', z' being the coordinates of a point on a conic, which is a unicursal curve, may be expressed in terms of a fourth new variable t as rational functions of t , and therefore x, y, z , the coordinates of a point on the inverse three-node quartic, can also be expressed in the same manner. For writing

$$\frac{x'}{f_1(t)} = \frac{y'}{f_2(t)} = \frac{z'}{f_3(t)} = \frac{1}{F(t)},$$

where $F=f_1+f_2+f_3$ and $\phi = \frac{1}{f_1} + \frac{1}{f_2} + \frac{1}{f_3}$, we have

$$\frac{x}{1/f_1} = \frac{y}{1/f_2} = \frac{z}{1/f_3} = \frac{1}{\phi}.$$

So that if $x' = \frac{f_1}{F}$, etc., then $x = \frac{1}{\phi f_1}$, etc. Hence the "inverse" of any unicursal curve is itself unicursal.

In all such cases the integral $\int \phi(x, y) dx$ will only require

for its expression, rational integral algebraic functions and simple logarithmic transcendents.

The general cubic may be written $uvw=z$, where u, v, w, z are linear functions of x and y . Any point upon it may be defined by the equations $vw=\lambda z, u=\frac{1}{\lambda}$. If there be no node, the deficiency is unity. The curve is not then unicursal. But if these equations be solved for x and y , we have λx and λy expressed in the form $P+\sqrt{Q}$, where P and Q are rational polynomials in λ of degrees not higher than 2 and 4 respectively. Hence in this case, for the integration of $\int \phi(x, y)dx$ elliptic integrals will in general be required. Similarly, if the deficiency of the connecting relation be of higher degree, transcendents of a higher complexity than the elliptic integrals would in general be required.

NOTE I. GENERAL REVIEW.

1905. The functions of a single variable x , with which we have been more particularly concerned, may be classed as (I) Algebraic, (II) Transcendental.

(I) An Algebraic function is one which may be theoretically expressed as a root of the equation

$$f_0(x)y^n + f_1(x)y^{n-1} + \dots + f_n(x) = 0,$$

where n is a positive integer and f_0, f_1, \dots, f_n are polynomials, rational as regards x , but in which the coefficients may be either commensurable or incommensurable, real or imaginary, but independent of x .

This will include as particular cases,

(a) The general rational integral polynomial.

(b) The rational algebraic function, which is the ratio of two rational polynomials.

(c) The general irrational species, in which commensurable fractional indices may occur as powers of rational polynomials.

(II) Of Transcendental functions we have such as involve an exponentiation of the variable or the taking of a logarithm. And as the variable may be a complex quantity, this will include, besides the elementary cases of e^x or $\log x$, the trigono-

metrical or hyperbolic functions and their inverses. For a single exponentiation or the taking of a logarithm, the function is said to be a transcendent of the first order, but if these operations be repeated the function is said to be a transcendent of the second or higher order. Thus e^{e^x} , $\log \log \log x$ are said to be respectively of the second and third orders of transcendents.

We may also have any arithmetical combination of the sum, difference, product or quotient of two or more of these groups.

Such functions are said to be simple or elementary functions.

1906. We have, besides such functions as described above, transcendents of a higher degree of complexity, such as Soldner's function $\text{li}(x)$, which is $\int^x \frac{dx}{\log x}$ or $\int^x \frac{e^x dx}{x}$; the Cosine and Sine integrals, viz. $\text{Ci}(x) \equiv \int^x \frac{\cos x}{x} dx$; $\text{Si}(x) \equiv \int^x \frac{\sin x}{x} dx$; Fresnel's Integrals; Kramp's Integral; Spence's Transcendents, defined as $L^n(1 \pm x) = \pm \frac{x^1}{1^n} - \frac{x^2}{2^n} \pm \frac{x^3}{3^n} - \frac{x^4}{4^n} \pm \text{etc.}$, the Elliptic Integrals, or others which have been computed and tabulated for special purposes.

1907. The problem of Integration with which we have been confronted is this: Supposing that we are given the differential equation $\frac{dy}{dx} = f(x)$, where $f(x)$ is one or other of the known classes of functions, or a combination of them, is it possible for us to solve this equation so that y can be recognised as itself one or other of these classes of functions or a combination of them? When no such solution exists y is a new transcendent.

1908. The general discussion as to how completely this question can be answered would occupy much more space than we have at disposal. The reader may be referred to Bertrand, *Calc. Int.*, ch. v., and to *Camb. Math. Tracts*, No. 2 (2nd ed.), by Mr. G. H. Hardy.

But we may remark that, in the first place, if $f(x)$ be a rational function of x , it appears from Chap. V. and the remarks in Note D that the integral y is in all cases partly

rational, partly logarithmic; that when the denominator is factorisable into linear or quadratic factors, the complete integral can be found. But when the denominator is of the fifth or higher degree and unfactorisable, though the rational part can be found by Hermite's process, the transcendental logarithmic portion can only be obtained in certain cases. But the only barrier to complete integration in all such general cases is that of the impossibility of solving the general quintic or higher degree equation.

If $f(x)$ be an irrational algebraic function of the form $\frac{A+B\sqrt{Q}}{C+D\sqrt{Q}}$, where A, B, C, D are rational polynomials and Q is a polynomial of not more than the fourth degree, it has been seen that its integration can always be effected, and when the degree of Q is not above the second, only simple functions will be required; but when Q is of the third or fourth degree, the integration will usually call for the assistance of the Elliptic Integrals.

It has also been seen that in all cases in which $\phi(x, y)$ is a rational integral algebraic function of x and y , and y is connected with x by an equation whose graph is unicursal, the integration $\int \phi(x, y) dx$ can be effected in terms of the elementary rational algebraic and logarithmic functions.

1909. In addition to these facts, a theorem due to Abel states that if y be an algebraic function of x , defined as above in (I) by the equation $f_0(x)y^n + f_1(x)y^{n-1} + \dots + f_n(x) = 0$, then $\int y dx$ can always be expressed as $B_0 + B_1y + \dots + B_{n-1}y^{n-1}$, where B_0, B_1, \dots, B_{n-1} are polynomials in x . And further, that in the case when $y^n = a$ a rational function of x , the integral $\int y dy = y \times a$ a rational function of x . The proof of the first of these theorems is somewhat difficult and long. Reference for them both may be made to the works already cited. Other forms for which $\int y dx$ is expressible by means of algebraic functions and logarithms will be found given by Bertrand.

1910. It may be noted that, since differentiation of a function involving irrational algebraic quantities or exponentials cannot destroy them, such quantities cannot appear upon the integration of a function that does not already contain them. Logarithms may appear upon the integration of an algebraic function, but always multiplied by mere constants and by no functions of x . For the operation of differentiation upon the result could not eliminate logarithmic terms otherwise involved.

If, therefore, the integral of an algebraic function be expressible by means of the simple functions at all, it cannot contain exponentials, and whatever logarithmic terms occur are such as to appear in the first degree as transcendents of the first order multiplied by constants.

Many cases have been discussed of the integration $\int f(x) dx$, in which $f(x)$ has involved exponential, logarithmic, trigonometric or hyperbolic functions, but there is no general rule which would indicate the nature of the result to be expected as there is in the case of rational algebraic functions, and the theory is far less complete. Reference may be made to Liouville's "Mémoire" (*Jour. f. Math.*, 1835).

PROBLEMS.

1. Integrate

$$(a) \frac{4x^5 - 1}{(x^5 + x + 1)^2}, \quad (b) \frac{1 - 7x^8 - 8x^9}{(1 + x^8 + x^9)^2}, \quad (c) \frac{x + 6x^5 + 12x^6 + 6x^{11}}{(1 + x + x^6)^2}.$$

2. Obtain the rational part of $\int \frac{1 + 2x + 6x^5 + 13x^6 + 6x^{11}}{(1 + x + x^6)^2} dx$.

3. Show that

$$\int_2^3 \frac{x^2(2x^3 - 1)(x^4 - 3x^2 + 2x + 1)}{(x^3 - x + 1)^2(x^4 - 2x + 1)} dx = \frac{1}{2} \log \frac{76}{13} - \frac{29}{175}.$$

4. Show that if $\int \frac{ax^2 + 2bx + c}{(a'x^2 + 2b'x + c')^2} dx$ be rational, $ac' + a'c = 2bb'$, and find the integral. [HARDY, No. 2, *Camb. Math. Tracts*, p. 18.]

5. Discuss the convergency of the integrals (a) $\int_0^{\frac{\pi}{2}} \log \sin x \, dx$,
 (b) $\int_0^{\infty} x^{n-1} e^{-x} \, dx$, (c) $\int_0^1 \frac{\log x}{1+x} \, dx$, (d) $\int_0^{\infty} \frac{x^{n-1}}{1+x} \, dx$.

6. Show that $\int_0^{\infty} \frac{\sin x}{x} \, dx$, although convergent, is not *absolutely* convergent.
 [CARSLAW, *Fourier's Series*, p. 103.]

7. If the function $\phi(x)$ be positive in sign, but diminishing in value as x varies from a to ∞ , then the series $\sum_0^{\infty} \phi(a+x)$ is convergent or divergent according as $\int_0^{\infty} \phi(x) \, dx$ is finite or infinite, and the series lies between $\int_a^{\infty} \phi(x) \, dx$ and $\int_{a-1}^{\infty} \phi(x) \, dx$.
 [CAUCHY, BOOLE, *F. Diff.*, p. 126.]

8. If $a > 0$, discuss the convergency of the series

$$(i) \sum_0^{\infty} \frac{1}{(a+n)^m}; \quad (ii) \sum_0^{\infty} \frac{1}{(a+n) \{\log(a+n)\}^m};$$

$$(iii) \sum_0^{\infty} \frac{1}{(a+n) \log(a+n) \{\log \log(a+n)\}^m}. \quad [\text{BOOLE, } l.c.]$$

9. In the curve $x^3 + y^3 + b^3 = 3axy$, show that we may express x and y in the form $2x - c + a\lambda = \pm R$, $2y - c + a\lambda = \mp R$, where

$$3R^2 = 4\lambda^3 - 9a^2\lambda^2 + 6ac\lambda - c^2 \quad \text{and} \quad c = a^3 - b^3,$$

by putting $x + y + a = c\lambda^{-1}$.

Hence show that $\int F(x, \sqrt[3]{a + \beta x + \gamma x^2 + \delta x^3}) \, dx$ can in all cases be reduced to an elliptic integral.
 [See HARDY, *l.c. sup.*, p. 50.]

10. Prove that

$$\int_0^{\infty} f\left(x + \frac{1}{x}\right) \log x \frac{dx}{x} = 0;$$

$$\int_0^{\infty} f\left(x + \frac{1}{x}\right) \tan^{-1} x \frac{dx}{x} = \frac{\pi}{4} \int_0^{\infty} f\left(x + \frac{1}{x}\right) \frac{dx}{x}. \quad [\text{LIOUVILLE.}]$$

11. If $f(x)$ be an even function of x , prove that

$$(i) \int_0^{\infty} f\left(x^2 + \frac{1}{x^2}\right) dx = \int_0^{\infty} f(x^2 + 2) dx;$$

$$(ii) \int_0^{\frac{\pi}{2}} f(\sin 2\theta) \sec \theta \, d\theta = 2 \int_0^{\frac{\pi}{2}} f(\cos^2 \theta) \sec \theta \, d\theta.$$

[GLAISHER.]

12. If $\phi(x) = \phi(2a - x)$, show that

$$(i) \int_0^a \phi(x) F(x) dx = \frac{1}{2} \int_0^a \phi(x) \{F(x) + F(a-x)\} dx;$$

$$(ii) \int_0^{\frac{\pi}{2}} f(\sin 2\theta) \sin^2 \theta d\theta = \frac{1}{2} \int_0^{\frac{\pi}{2}} f(\sin 2\theta) d\theta;$$

$$(iii) \int_0^{\frac{\pi}{2}} f(\sin 2\theta) \sec^2 \theta d\theta = 2 \int_0^{\frac{\pi}{2}} f(\cos \theta) \sec^2 \theta d\theta. \quad [\text{GLAISHER.}]$$

13. If $I_n = \int_0^{\pi} x^n f(\sin x) dx$, show that if n be an odd integer,

$$(i) 2I_n - n\pi I_{n-1} + \frac{n(n-1)}{1 \cdot 2} \pi^2 I_{n-2} - \dots - \pi^n I_0 = 0;$$

$$(ii) (n+1) I_n - \frac{(n+1)n}{1 \cdot 2} \pi I_{n-1} + \frac{(n+1)n(n-1)}{1 \cdot 2 \cdot 3} \pi^2 I_{n-2} - \dots - \pi^n I_0 = 0. \quad [\text{GLAISHER.}]$$

14. Prove that if $\phi(x) = \phi(1-x)$, then will

$$(i) \int_0^1 \phi(x) \log \Gamma(x) dx = \frac{1}{2} \log \pi \int_0^1 \phi(x) dx - \frac{1}{2} \int_0^1 \phi(x) \log \sin \pi x dx;$$

$$(ii) \int_0^1 \sin \pi x \log \Gamma(x) dx = \frac{1}{\pi} \log \pi - \frac{1}{\pi} (\log 2 - 1);$$

$$(iii) \int_0^1 \sin^2 \pi x \log \Gamma(x) dx = \frac{1}{8} (2 \log 2\pi - 1). \quad [\text{GLAISHER.}]$$

15. By the transformation $x = \frac{1-y}{1+y}$, show that

$$\int_0^1 \tan^{-1} \frac{3(1+x)}{1-2x-x^2} \cdot \frac{dx}{1+x^2} = \frac{\pi^2}{8}. \quad [\text{GLAISHER.}]$$

16. Show that the curve $\theta = \phi$ on unit sphere consists of two loops each of area $\pi - 2$; θ and ϕ being colatitude and azimuthal angle.

17. Show that the solid angle of the cone

$$z^2(x^2 + y^2)^2 = x^4(x^2 + y^2 + z^2)$$

is π .

18. Examine the nature of the curve on unit sphere defined by the equation $2 \sin \frac{1}{2} \theta \cos \frac{1}{2} \phi = 1$, and show that the solid angle of this cone is $2\sqrt{3}$.

19. Prove that

$$\iint \rho^{-2} \cos \theta \cos \theta' dS dS' = -\frac{1}{2} \iint \log \rho \cos \psi ds ds',$$

where dS, dS' are any elements of two unclosed surfaces over which the first integral is taken, and ρ the distance between them which makes angles θ and θ' with the normals at its extremities; also ds, ds' are any two elements of their bounding arcs over which the second integral is taken, the directions of these elements of arcs being inclined at an angle ψ . Give an optical interpretation of the result.

[MATH. TRIP., 1886.]

[See Arts. 846, 1783, and Herman, *Optics*, Art. 157.]

20. If x, y, z be each real, finite and determinate functions of $\cos \alpha, \sin \alpha \cos \beta$ and $\sin \alpha \sin \beta$, the locus of the point x, y, z will be a closed surface containing a volume

$$\frac{1}{3} \int_0^\pi \int_0^{2\pi} \begin{vmatrix} x_\alpha & y_\alpha & z_\alpha \\ x_\beta & y_\beta & z_\beta \\ x & y & z \end{vmatrix} du d\beta, \quad \text{where } x_\alpha \equiv \frac{\partial x}{\partial \alpha}, \text{ etc.}$$

[MATH. TRIP., 1870.]

21. The volume enclosed by a closed oval (synclastic) surface is V ; its area is S , and I denotes the integral $\iint \left(\frac{1}{\rho_1} + \frac{1}{\rho_2} \right) d\sigma$ extended over the surface, ρ_1, ρ_2 being the principal radii of curvature at the point where $d\sigma$ is the element of area. A sphere of any diameter rolls on the outside of the surface; and for the envelope of the sphere the corresponding integrals are constructed. Show that

$$V - \frac{1}{8\pi} I \cdot S + \frac{1}{192\pi^2} I^3$$

is the same for the envelope as for the original surface.

22. Show that the length of an arc of a curve on the sphere $x^2 + y^2 + z^2 = r^2$ may be expressed in terms of the coordinates u, v of a point on a plane curve by the transformation

$$\frac{x}{4r^2u} = \frac{y}{4r^2v} = \frac{z}{(u^2 + v^2 - 4r^2)r} = \frac{1}{u^2 + v^2 + 4r^2},$$

by the formula

$$s = \int \frac{\sqrt{du^2 + dv^2}}{1 + (u^2 + v^2)/4r^2}.$$

[G. B. MATHEWS, *Nature*, Feb. 1921. Art. on "Einstein's Theory of Relativity".]

CHAPTER XXVI.

PAGE 212.

4. $\pi/2$.
5. A system of discontinuous lines and points, the origin being the centre of the system,
 $(-\infty < x < -1)$, $x = -1$, $(-1 < x < -\frac{1}{3})$, $x = -\frac{1}{3}$, $(-\frac{1}{3} < x < 0)$,
 $y = -\frac{\pi}{4}$, $y = -\frac{\pi}{16}$, $y = \frac{\pi}{8}$, $y = \frac{\pi}{16}$, $y = 0$, etc.
6. The part of the plane $z = 1$ between $y = \pm x$
 which contains $(1, 0, 1)$.
 The part of the plane $z = -1$ between $y = \pm x$
 which contains $(-1, 0, -1)$.
 The parts of the plane $z = 0$ between $y = \pm x$
 which contain the y -axis.
 The portions of the lines $x/1 = y/1 = (z - \frac{1}{2})/0$,
 $x/1 = y/(-1) = (z - \frac{1}{2})/0$, for which x is positive.
 The portions of the lines $x/1 = y/1 = (z + \frac{1}{2})/0$,
 $x/1 = y/(-1) = (z + \frac{1}{2})/0$, for which x is negative.
9. A staircase of "treads and risers," the former consisting of lines, the latter marked by points.

PAGE 237.

4. $\sqrt{\frac{\pi}{a}} e^{\frac{b^2 - 4ac}{4a}}$.
6. $\frac{1}{2^m m} \int_0^{\frac{\pi}{2}} \sin^{m-1} \theta d\theta = \text{etc.}$
20. (a) 0, (b) $\frac{1}{2}$, (c) ∞ , (d) $\frac{1}{2}$.
23. $\frac{2\pi}{\sqrt{3}} e^{-m \frac{\sqrt{3}}{2}} \cos \frac{m}{2}$.
33. $\frac{2}{\sqrt{\pi}} \int_0^{\infty} e^{-y^2} \left\{ 1 - e^{-\frac{1}{y^2} (\log \frac{1}{\sqrt{x}})^2} \right\}^{-1} dy$.
42. $\sqrt{\pi/2e}$.

CHAPTER XXVII.

PAGE 289.

27. (i) $\log \frac{n+2}{n}$; (ii) $(n+4) \log(n+4) - 2(n+2) \log(n+2) + n \log n$;
 (iii) $\frac{1}{2} \{ (n+6)^2 \log(n+6) - 3(n+4)^2 \log(n+4) + 3(n+2)^2 \log(n+2) - n^2 \log n \}$.

CHAPTER XXVIII.

PAGE 353.

2. $\frac{k^n \cdot k!}{(k+n)(k+n-1) \dots n}$.
14. $\pi a^n / 2n$.
23. $\beta - \beta' = \gamma - \gamma'$; $a'\gamma' + a\gamma + a'\beta + \beta\gamma' = a\gamma + a'\gamma + a\beta' + \beta'\gamma$;
 $a'\gamma'(a + \beta) = a\gamma(a' + \beta')$.
30. $\pi/4$.
33. $\frac{\pi}{a\sqrt{1+a}} \left(\frac{1}{\sqrt{1-a}} - \frac{1}{\sqrt{1+a}} \right)$.
57. $\frac{\pi}{4} \log \frac{a+b}{a-b}$.

CHAPTER XXIX.

PAGE 415.

1. (i) $(x^2 + y^2)^{\frac{n}{2}}$, $n \tan^{-1} \frac{y}{x}$;
 (ii) $\sqrt{(\log \sqrt{x^2 + y^2})^2 + (\tan^{-1} y/x)^2}$, $\tan^{-1} \frac{\tan^{-1} y/x}{\log \sqrt{x^2 + y^2}}$; (iii) a^x , $y \log a$.
 (iv) $e^{a \log \sqrt{x^2 + y^2} - b \tan^{-1} y/x}$, $b \log \sqrt{x^2 + y^2} + a \tan^{-1} y/x$.
 (v) $\sqrt{\cosh^2 y - \cos^2 x}$, $\tan^{-1} \frac{\tanh y}{\tan x}$;
 (vi) $\sqrt{\cosh^2 y - \sin^2 x}$, $-\tan^{-1}(\tan x \tanh y)$;
 (vii) $\frac{2\sqrt{\sinh^2 y + \cos^2 x}}{\cos 2x + \cosh 2y}$, $\tan^{-1}(\tan x \tanh y)$.
 (viii) $\frac{1}{2} \left[\left(\tan^{-1} \frac{2x}{1 - x^2 - y^2} \right)^2 + \left(\tanh^{-1} \frac{2y}{1 + x^2 + y^2} \right)^2 \right]^{\frac{1}{2}}$,
 $\tan^{-1} \left\{ \tanh^{-1} \frac{2y}{1 + x^2 + y^2} / \tan^{-1} \frac{2x}{1 - x^2 - y^2} \right\}$.
4. (i) $-1 \pm \iota$, $2 \pm \iota\sqrt{2}$; (ii) $1 \pm \iota$, $-2 \pm \iota\sqrt{2}$;
 (iii) $-1 \pm \iota$, $-2 \pm \iota\sqrt{2}$; (iv) $1 \pm \iota$, $2 \pm \iota\sqrt{2}$.
5. (i) One in each quadrant; (ii) n in each quadrant;
 (iii) One in each quadrant and one on negative part of x -axis;
 (iv) and (v) n in each quad. and one on -" part of x -axis;
 (vi) n in each quad. and one on each part of y -axis.
6. (i) $\pm \iota$, $\pm 2\iota$, $-1 \pm \iota$; (ii) $\pm \iota$, $\pm 2\iota$, 6.
7. (i) Cassinian, (ii) Two st. lines, (iii) Rect. Hyp.
8. $(X^2 - a^2 \cos^4 c)^{\frac{3}{2}} / a^2 \sin c \cos^4 c$. 9. $\rho = a^3 / 4r^2$. 11. A diameter.
15. (ii) $X_s = ae^{-\frac{Y_m}{a}} \cos \frac{X_m}{a}$, $Y_s = ae^{-\frac{Y_m}{a}} \sin \frac{X_m}{a}$;
 (v) (a) Concurrent lines, Meridians; (b) Conc. circles, Parallels of lat.;
 (c) Equi. spirals, Rhumb lines.
16. $(a_1^n - a_2^n)(b_1^n - b_2^n) / n^2$.

CHAPTER XXX.

PAGE 479.

1. (i) $\frac{2}{3}(z_1 - 1)^{\frac{3}{2}} + \frac{2}{3}\iota$, (ii) $\frac{2}{3}\iota - \frac{2}{3}(z_1 - 1)^{\frac{3}{2}}$. 2. $2\pi\iota \sin a$, $2\pi\iota \cos a$, $-\pi\iota \sin a$
 3. $2\pi\iota a$, $4\pi\iota a$, $2\pi\iota$, 0. 12. $z/\sqrt{u^2 - z^2}$.
 17. $\frac{2\pi\iota}{3a^2} \left(\sin a + \sin \frac{a}{2} \cosh \frac{a\sqrt{3}}{2} - \sqrt{3} \cos \frac{a}{2} \sinh \frac{a\sqrt{3}}{2} \right)$, if $a < 1$; 0 if $a > 1$.
 18. 0 if $a > 1$, $2\pi\iota \log(1 - a) - 2\pi^2$ if $a < 1$. 19. π , 2π , 2π .

CHAPTER XXXI.

PAGE 520.

6. $a = -\frac{1}{2}$, $\alpha = \frac{5}{12}\pi$.
22. (i) $\frac{1}{k} \sin^{-1}(k \operatorname{sn} u)$; (ii) $\frac{1}{k} \sinh^{-1}\left(\frac{k'}{k} \operatorname{cn} u\right)$; (iii) $\operatorname{tn} u - \operatorname{am} u$.
31. (i) $\operatorname{am} u$; (ii) $-\frac{1}{k} \tan^{-1}\left(\frac{1}{k} \operatorname{ctn} u\right)$; (iii) $-\operatorname{sech}^{-1}(k \operatorname{sn} u)$.
62. $\{(x^2 + y^2)(1 - x^2 y^2) - c^2(1 + x^2 y^2)^2\}^2 = 4x^2 y^2(1 - x^4)(1 - y^4)$.
63. Put $y = (1 + k)x/(1 + kx^2)$. Multiplier $1/(1 + k)$, Mod $2\sqrt{k}/(1 + k)$.

CHAPTER XXXII.

PAGE 561.

11. $\wp^{n+1}(u)/(n+1)$; $\log \wp(u)$; $e^{\wp(u)}$; $2\sqrt{4\wp^3(u) - I\wp(u) - J}$.
12. $\frac{1}{2}\wp'(u) + \frac{1}{12}Iu$; $\frac{1}{24}I\wp''(u) - \frac{1}{24}I\zeta(u) + \frac{1}{24}Ju$; $AP_6 + BP_1 - C\zeta(u) + Du$
 (Art. 1432); $\frac{1}{\wp'(v)} \left[\log e^{2u\zeta(v)} \frac{\sigma(u-v)}{\sigma(u+v)} + C \right]$, where $\wp(v) = 0$;
 $\frac{1}{\{\wp'(v)\}^2} \left[-\zeta(u-v) - \zeta(u+v) - 2u\wp(v) - \wp'(v) \int \frac{du}{\wp(u)} \right]$;
 $\frac{1}{2\{\wp'(v)\}^3} \left[-\wp(u-v) - \wp(u+v) - 2u\wp'(v) - \wp''(v) \int \frac{du}{\wp(u)} - 3\wp'(v)\wp''(v) \int \frac{du}{\{\wp(u)\}^2} \right]$.
19. $y = c_1\phi(u, v) + c_2\phi(u, -v)$.
32. (i) $\frac{1}{6}\wp'u + \left\{ (\wp v)^2 + \frac{I}{12} \right\} u + 2\wp(v)\zeta(u) + C$;
 (ii) $\frac{1}{\{\wp'(v)\}^2} \left[-\zeta(u-v) - \zeta(u+v) - 2u\wp(v) - \frac{\wp''(v)}{\wp'(v)} \left\{ \log e^{2u\zeta(v)} \frac{\sigma(u-v)}{\sigma(u+v)} \right\} \right] + C$.
39. $x = \left\{ \wp\left(\frac{\omega_1}{2}\right) - \wp(\omega_1) \right\} / \left\{ \wp\left(\frac{\omega_2}{2}\right) - \wp(\omega_2) \right\}$.

CHAPTER XXXIII.

PAGE 598.

1. $I = 1 + 3\lambda^2$, $J = \lambda^3 - \lambda$, $H = -144[\lambda(x^4 + y^4) - (1 - 3\lambda^2)x^2y^2]$,
 $\Delta = (9\lambda^2 - 1)^2$.
8. $z = \wp(u, 39, 25)$, $x = z/(z-1)$. 10. $z = -3 + 6/x^2$.
12. $\sin^{-1}u$, $\cos^{-1}u$, 1, $\tan u$, for $k=0$; $\tanh^{-1}u$, $\operatorname{sech}^{-1}u$, $\operatorname{sech} u$, $\sinh u$,
 for $k=1$.
14. $\frac{1}{\sqrt{e_1 - e_2}} \tan^{-1} \sqrt{\frac{e_1 - e_2}{z - e_1}}$; $\frac{1}{\sqrt{e_1 - e_2}} \tanh^{-1} \sqrt{\frac{e_1 - e_2}{z - e_3}}$; $(z - e_1)^{-\frac{1}{2}}$.
15. $u = \wp^{-1}(y, 0, 36)$, $y = 1 + t^2$; or $u = \frac{1}{\sqrt{6}} \operatorname{sn}^{-1} \sqrt{\frac{6}{t^2 + 4}}$, mod $\frac{1}{\sqrt{2}}$
16. $-2\frac{1}{2}u = \wp^{-1}(z, 0, \frac{1}{3})$, $t = 1/4z$. $(t^2 = -4 + \frac{6}{z^2})$.

22. (i) $2[\zeta(a) - \zeta(u)]$, where $z = \wp(u, 0, 4)$ and $\wp(a) = a$;
 (ii) $-\frac{1}{\sqrt{7}} \log e^{2u\zeta(a)} \frac{\sigma(a-u)}{\sigma(a+u)}$, where $z = \wp(u, 0, 4)$, $u = \wp^{-1}(2, 0, 4)$;
 (iii) $2u - \frac{25}{7\sqrt{7}} \log e^{2u\zeta(a)} \frac{\sigma(a-u)}{\sigma(a+u)} - \frac{2}{7} [\zeta(u-a) + \zeta(u+a) - 4u]$, $a = \wp^{-1}(2, 0, 4)$;
 (iv) $-\frac{3\sqrt{3}}{74} \log e^{2u\zeta(a)} \frac{\sigma(a-u)}{\sigma(a+u)} + \frac{3}{\sqrt{2}} \log e^{2u\zeta(\beta)} \frac{\sigma(\beta-u)}{\sigma(\beta+u)}$,
 where $x = \frac{5}{3} + \wp(u, \frac{5}{3}, -\frac{3}{2}\frac{5}{3})$, $\wp(a) = 2$, $\wp(\beta) = 1$
 (v) $u + \log e^{2u\zeta(a)} \frac{\sigma(a-u)}{\sigma(a+u)}$, where $x = \frac{\wp(u, 0, -4) - 8}{\wp(u, 0, -4) - 2}$ and $\wp(a) = 2$.
23. $I = \frac{\sqrt{e_1 - e_2}(e_2 - e_3)}{e_1 e_2 + 2e_3^2} \left[e_1 u + \zeta(u) + \frac{1}{2} \frac{\wp'(u)}{\wp(u) - e_3} \right]$.
24. $I = \sqrt{e_1 - e_3} u + \frac{(e_1 - e_3)^{\frac{3}{2}} a^2}{\wp'(v)} \log \left\{ e^{2u\zeta(v)} \frac{\sigma(v-u)}{\sigma(v+u)} \right\}$,
 where $v = \wp\{e_3 + (e_1 - e_2)a^2, I, J\}$
27. $u\sqrt{3} = K - \text{am } u$, $x\sqrt{3} = \text{sn } u \sqrt{3} / \text{dn } u \sqrt{3}$; $\text{mod } \sqrt{2/3}$;
 or $y = \wp(\omega_1 - u)$ where $y = z + \left(\frac{9}{16}\right) \frac{6}{6z+1}$ and $x = (12z-7)/(12z+11)$.
28. $u = \frac{2}{\sqrt{(a_4 - a_2)(a_1 - a_3)}} \text{sn}^{-1} \left(\sqrt{\frac{a_2 - a_4}{a_2 - a_1} \cdot \frac{x - a_1}{x - a_4}}, \sqrt{\frac{a_2 - a_1}{a_3 - a_1} \cdot \frac{a_3 - a_4}{a_2 - a_4}} \right)$
 (Art. 1339).

CHAPTER XXXIV. SECTION I.

PAGE 650.

- The points are opp. extremities of a diam. of a circle, centre at origin diam. = a .
- $y = \sinh nx / \sinh na$.
- $r^m \sin m\theta = a^m$, where $(n+1)m = n$.

6.	i	ii	iii	iv	v	vi
Force/ $u^2 =$	y/a^2	$a/2y^2$	$a^2y/(a^2+y^2)^2$	a^2/y^3	y/a^2	$a/2y^2$
	rep.	att.	rep.	att.	att.	rep.
Line	$y=0$	$y=\infty$	$y=0$	$y=\infty$	$y=a$	$y=a$
	vii	viii	ix	x		
Force/ $u^2 =$	a^2/y^3	$1/3a^{\frac{1}{2}}y^{\frac{1}{2}}$	$\frac{2a^4y^3}{(a^4+y^4)^2}$	$\frac{a^2b^4}{\{b^4+(a^2-b^2)y^2\}^2}$		
	rep.	att.	att.	rep.		
Line	$y=a$	$y=a$	$y=\infty$	$y=0$		

7.

	i	ii	iii	iv	v	vi	vii	viii
Force \propto	const.	r	r^2	r^3	r^5	r^{-3}	r^{2n+1}	r
	rep.	rep.	rep.	rep.	rep.	att.	rep. $n > -1$ att. $n < -1$	rep.
Circle	$r=0$	$r=0$	$r=0$	$r=0$	$r=0$	$r=\infty$	$r=0$ $r=\infty$	$r=a$

	ix	x	xi	xii
Force \propto	$p^2 = Ar^2 + B$ r	$\frac{1}{p^2} = \frac{1}{r^2} + \frac{1}{a^2}$ $r/(r^2 + a^2)^2$	$\frac{a^2 b^2}{p^2} = a^2 + b^2 - r^2$ $r/(a^2 + b^2 - r^2)^2$	$\frac{b^2}{p^2} = \frac{2a}{r} - 1$ $1/(2a - r)^2$
	rep. $A +$ att. $A - "$	rep.	rep.	rep.
Circle	$r = \sqrt{\frac{-B}{A}}$	$r=0$	$r=\infty$	$r=0$

9. The parabola $11(y - 1) + 3x(x + 4) = 0$ satisfies the conditions.
 10. Two straight lines equally inclined in opp. directions to the x -axis.
 11. Rect. Hyp.
 12 and 13. Circular arc. Discont. solutions as in Art. 1505 (1).
 14. A central conic. 16. $y = a \sin \frac{\pi x}{l}$, where a is known.
 19. Ellipse. Centre on initial line. Action a min. Free path under att. radial force to focus.
 22. A circle. 25. A. catenary.
 28. A circle. Max. area for given length [$p = A + B \cos(\psi + \alpha)$].
 31. Parabolic arc wrapped on a cone. Focus at vertex. Axis along a generator

CHAPTER XXXIV. SECTION II.

PAGE 692.

1. $y = a \cosh n(x - b)$. Minimum.
 3. Taking $c + "$ and
 $x_0 > -a, (x_1 > x_0 > -a, \text{min.}), (x_0 > x_1 > a, \text{max.}), (x_0 > -a > x_1, \text{neither});$
 $x_0 < -a, (x_1 < x_0, \text{max.}), (x_0 < x_1 < -a, \text{min.}), (x_0 < -a < x_1, \text{neither}).$

CHAPTER XXXV. SECTION I.

PAGE 717.

1. If a cosine curve $y = \cos x$ be drawn from $x=0$ to $x=\pi$ and a point placed at the origin, the total graph consists of this portion with repetitions from π to $2\pi, 2\pi$ to 3π , etc.
 10. $\phi(x) = \sum_1^{\infty} A_n \sin \frac{n\pi x}{a_3}$, where
 $A_n = \frac{2}{n\pi} \left[c_1 \left(1 - \cos n\pi \frac{a_1}{a_3} \right) + c_2 \left(\cos n\pi \frac{a_1}{a_3} - \cos n\pi \frac{a_2}{a_3} \right) + c_3 \left(\cos n\pi \frac{a_2}{a_3} - \cos n\pi \right) \right]$.

11. $\phi(x) = A_0 + \sum_1^{\infty} A_n \cos 2n\pi x/a_3 + \sum_1^{\infty} B_n \sin 2n\pi x/a_3$, where
 $A_0 = \{c_1 a_3 + c_2(a_2 - a_1) + c_3(a_3 - a_2)\}/a_3$,
 $A_n = \frac{1}{n\pi} \{c_1 \sin 2n\pi a_1/a_3 + c_2(\sin 2n\pi a_2/a_3 - \sin 2n\pi a_1/a_3)$
 $\quad - c_3 \sin 2n\pi a_2/a_3\}$,
 $B_n = \frac{1}{n\pi} \{c_1(1 - \cos 2n\pi a_1/a_3) + c_2(\cos 2n\pi a_1/a_3 - \cos 2n\pi a_2/a_3)$
 $\quad + c_3(1 - \cos 2n\pi a_2/a_3)\}$.
14. Repetitions of the portion of $y = x(\pi^2 - x^2)/12$ which lies between $x = \pm \pi$.

CHAPTER XXXV. SECTION II.

PAGE 737.

1. $\frac{8a}{\pi^2} \sum_0^{\infty} \frac{1}{(2r+1)^2} \cos \frac{(2r+1)\pi x}{2a}$.
2. $\frac{\pi^2}{3} + 4 \sum_1^{\infty} (-1)^r \frac{1}{r^2} \cos rx$ ($-\pi < x < \pi$). A series of equal parabolic arcs.
3. $\frac{4kl}{\pi^2} \sum_0^{\infty} (-1)^r \frac{1}{(2r+1)^2} \sin \frac{(2r+1)\pi x}{l}$; $\frac{kl}{4} - \frac{2kl}{\pi^2} \sum_0^{\infty} \frac{1}{(2r+1)^2} \cos \frac{(2r+1)2\pi x}{l}$.
4. $\frac{8}{\pi} \sum_0^{\infty} \frac{1}{(2r+1)^3} \sin (2r+1)x$; 0 to π inclusive.
5. $\frac{2nk}{\pi^2} \sum_1^{\infty} \frac{1}{p^2} (1 - \cos p\pi) \sin \frac{p\pi}{n} \sin \frac{p\pi x}{l}$.
6. $y = -\frac{a\pi^2}{8c} x$ (0 to $2c - a$); $y = -\frac{2c-a}{8c} \pi^2(2c-x)$, ($2c - a$ to $2c$).
7. $\sum_1^{\infty} A_n \sin \frac{n\pi x}{l}$, $A_n = \left(-\frac{l^2}{2n\pi} + \frac{4l^2}{n^3\pi^3}\right) \cos \frac{n\pi}{2} + \frac{2l^2}{n^2\pi^2} \sin \frac{n\pi}{2} - \frac{4l^2}{n^3\pi^3}$,
 $B_0 + \sum_1^{\infty} B_n \cos \frac{n\pi x}{l}$, $B_n = \left(\frac{l^2}{2n\pi} - \frac{4l^2}{n^3\pi^3}\right) \sin \frac{n\pi}{2} + \frac{2l^2}{n^2\pi^2} \cos \frac{n\pi}{2}$, $B_0 = \frac{l^2}{24}$.
10. $\frac{l^2}{48a} + \frac{l^2}{a\pi^2} \sum_1^{\infty} \frac{1}{r^2} \cos \frac{r\pi}{2} \cos \frac{r\pi x}{l}$; repetitions of the part between $x=0$ and $x=l$.
13. If $f(x)$ changes to $\phi(x)$ and $f'(x)$ to $\phi'(x)$ at $x=a$,
 $A_n \frac{l}{2} = \int_0^a f(x) \sin \frac{n\pi x}{l} dx + \int_a^l \phi(x) \sin \frac{n\pi x}{l} dx$,
 $B_n \frac{l}{2} = \frac{n\pi}{l} A_n + \frac{2}{l} \left[f(a) \cos \frac{n\pi a}{l} - f(0) \right] + \frac{2}{l} \left[\phi(l)(-1)^n - \phi(a) \cos \frac{n\pi a}{l} \right]$.
16. $u = \frac{1}{\pi} \sum_1^{\infty} \frac{a^n b^n}{a^{2n} - b^{2n}} \left(\frac{r^n}{b^n} - \frac{b^n}{r^n} \right) \int_0^{2\pi} f(\phi) \cos n(\phi - \theta) d\phi$.
19. $\frac{4}{\pi} \sum_0^{\infty} \frac{1}{2r+1} \sin (2r+1) \frac{\pi x}{a}$.
27. $C = \frac{1}{2} \tan^{-1} \frac{2m \cos \theta}{1 - m^2}$. Arc of a circle, centre at the origin, and radius $\frac{1}{2}\pi a$ symmetrically placed about the initial line, and subtending an angle $\pi - 2\alpha$ at the origin; together with the origin itself.

- Chartres, 1662.
 Chasles, 583, 584.
 Chauvenet, 1778, (ii) p. 876.
 Chrystal, 1900, 1901.
 Circular Arc, 525.
 Clausius, (i) p. 63.
 Clerk Maxwell, 467, 604, 1671, etc.,
 (ii) p. 791, 1790.
 Clifford, 382.
 Coffin, (i) p. 522.
 Complex Constants, 1189, etc.; Vari-
 ables, 1202, etc., 1266.
 Condensation graph, 1692.
 Condorcet, 1701.
 Conformal representation, 1235, etc.
 Conjugate points on stationary curve,
 1576.
 Continuity, 1225, etc., 1895.
 Contour integration, 1301, etc.
 Convergence of infinite integral, 1884
et seq.
 Cornu, 560, 1169.
 Corresponding points, 463.
 Cotes' Spirals, 609.
 Cournot, (ii) p. 150.
 Crofton, 1727-1731, (ii) p. 851.
 Cullen, (ii) p. 242.
 Culverwell, 1568, etc.
 Curvature (conformal representation),
 1251.
 Curves on cylinder, 717; sphere,
 721.
 Cycloid, 518, 540.
 Cylindrical Coordinates, 774, 777.
 Cylindroid, 1896.
 Czuber, 1725.
 D'Alembert: Mortality Curve, 1736,
 1742.
 Definite Integrals.
 988-1070. Some well-known In-
 tegrals.
 1071-1120. Various groups, Logar-
 ithmic.
 1121-1201. Derivation from Series,
 etc.
 Deformation of path, 1276.
 De Moivre, 1217.
 De Morgan, 706, 897, 916, 945-949,
 957, (ii) p. 147, (ii) p. 148, (ii) p.
 150, 1180, 1200, (ii) p. 650, 1548,
 1751, (ii) p. 741.
 Density of Distribution, 1692.
 Differentiation.
 Definite Integral, 354, 1898, 1902.
 Multiple Integral, 364.
 Dimidiation, 1356, 1359.
 Dirichlet, 958, etc., 1601, 1616, (ii)
 p. 936.
 Divergence Theorem, 1783.
 Donkin, 1600.
 Double Differentiation and Integra-
 tion, 360, 1897, 1899.
 Double Limits, 1902.
 Duplication, 1355.
 Eccentric Anomaly, 1156.
 Einstein, (ii) p. 965.
 Elastica, 603-607.
 Elementary functions, 1905.
 Elliott, 495, 1182, etc., 1187.
 Ellipse, Orbit, 199; Rectification, 567.
 Ellipsoid, 761.
 Elliptic Coordinates, 812.
 Elliptic functions. Periodicity, 375.
 Legendrian, 367, etc., 1329, etc.
 Weierstrassian, 1380, etc.
 Reduction, 1446, etc.
 Encke, 1778.
 Energy condition of equilibrium, 1545.
 Epicycloid, 540, 556.
 Epinome, 372.
 Equations of Condition, 1761
 Normal, 1764.
 Equiangular Spiral, 528, 529.
 Errors, 1744, etc., m.e.; e.m.s.; p.e.,
 1750, 1752, 1757.
 Eta function (Jacobi), 1366.
 Euler, (i) pp. 103 and 104, (i) pp. (316,
 318, 319, 371, 382, 536, 852, 853,
 856, 864; Euler's Constant, 897,
 911, 915, 917, 932, 1079, 1081,
 1099, (ii) p. 268, 1166; Euler's
 Numbers, 879, 1073.
 Exclusion of poles, 1285.
 Expansions: $\varphi(u)$, 1416; $\zeta(u)$, 1418;
 $\sigma(u)$, 1418; Taylor, 1300; Cauchy
 for $\log \Gamma(x+1)$, 940; Spherical
 Harmonics, 1868, etc.; Legendre,
 1832, etc.
 Expectation of Life, 1741.
 Factorial Series, 950.
 Fagnano, 370, 575.
 Fermat, 518.
 Ferrers, 382, 450, 693, 1155.
 Forsyth, 1553, (ii) p. 742.
 Fourier, (ii) p. 241, 1201; Theorem,
 1589, 1591, 1626, 1637.
 Frequency Curve, 1692; Law, 1747.
 Fresnel, 560, 1166, 1169, 1172, etc.,
 1323.
 Frullani, 989, 1014, 1182.
 Functionality, 1228.

- Gamma Function, 232, 855 onwards :
 Graph, 922.
- Gauss, 823, 873, 874, 882, 886, 903, 905, 954, 962, 987, 1653, 1778, (ii) p. 877.
- General Theorems.
 321, etc. From definition of Cauchy.
 1881, etc. From definition of Riemann.
- General value, 344.
- Generalised formulae (Rectification), 739.
- Genocchi, 615.
- Geodesic, 714, 1524 *et seq.*
- Ghosh, (ii) p. 242.
- Gilbert, 560, 1169; Tables, 1176.
- Girard, 781.
- Glaisher, 877, (ii) p. 213, 1074, (ii) p. 292, 1155, (ii) p. 361, 1373, 1374, (ii) p. 526, 1749, 1778, 1779, (ii) pp. 963, 964.
- Glissette, 686, etc.
- Graves, 583, 586.
- Green, 1782, 1784, etc.
- Greenhill, 59, 68, 70, 71, 184, 305, 316, 382, 578, 581, 604, 1350, 1351, (ii) p. 525, p. 527, p. 528, 1398, (ii) p. 562, 563, 1480, (ii) p. 659.
- Gregory (Series), 953.
- Gregory and Walton, 516, 856, 970, 972, 1049, 1068, (ii) p. 241, 1117, (ii) p. 290, 1201.
- Gudermann, 69, (ii) p. 149.
- Guldin, 752.
- Hall, (i) p. 319, (i) p. 359.
- Halphen, 1245.
- Hansen, 1778.
- Hardy, (ii) p. 243, 1894, 1908, (ii) p. 962.
- Harkness and Morley, 1238, 1262, (ii) p. 416, 1900.
- Helix, 712.
- Herman, (ii) p. 965.
- Hermite, 206, (i) p. 205; Rational integral forms, 1891, etc.
- Heterogeneous medium (Ray), 1536.
- Hobson, 59, 68, 70, 71, 614, 871, 873, 899, 994, 999, 1002, 1007, 1900.
- Holditch, 478, 484.
- Holomorphic functions, 1245.
- Homographic relation, 1255.
- Huygens, 518, (i) p. 533.
- Hyperbola, 388; Rectification, 588, 591.
- Hyperbolic functions, 59, 180, 184, 188, 189, 192, 194, 197.
- Periodicity of, 67.
- I*-loci, 656.
- Infinite Series, 1274, 1900.
- Instantaneous Centre, 649.
- Integration. Standard forms, 44, 89.
 by change of variable, 47, etc.
 by parts, 90.
 Sines, cosines, 114, etc.
 Rational Algebraic forms, 127, 1891, etc.
 Form $(a + b \cos x + c \sin x)^{-1}$, etc., 170, etc.
 Reduction, 208, etc.
 Form $F(x, \sqrt{R})$, 275.
 in terms of integrand, 182, etc.
 by Weierstrassian forms, 1433, etc.
- Intrinsic Equation, 438, 536, etc.
- Inverse Curves, 443, 621.
- Inverse Probability, 1696.
- Inversion, 725.
- Involute of circle, 555.
- Isogonal property, 1247.
- Isoperimetric companionship, 701, etc.
- Ivory, (ii) p. 47; Equation, 1867.
- i-y* Equations, 688.
- Jacobi, 377, 833, (ii) p. 48, (ii) p. 241.
- Jacobi's 33 formulae, 1351.
- Jacobian functions, 377, 1329, etc.
- Jacobians, 833, etc.
- $K = 0$ (Integrability of), 1500.
- Kelvin (Lord). See Thomson and Tait.
- Kempe, 488, 499.
- Kenelly, 70.
- Kirchoff, (ii) p. 525.
- Knockenhauer, 560, 1169, 1175.
- Kramp, Table, 1751.
- Kummer, 989, 1100.
- Lacroix, (i) p. 322, 852, (ii) p. 148, (ii) p. 652, 1548, (ii) p. 692.
- Lagrange, 365, 366, 371, 504, 852, 853, 1584.
- Lagrange's Rule, 1504, 1558.
- Landen, 371, 1120, (ii) p. 291; Transformation, 1480.
- Laplace, 895, 1037, 1041, 1046, 1048, 1051, (ii) p. 238, 1166, 1696, 1701, 1704, (ii) p. 852, 1746, 1778.
- Laplace's Equation: Various forms, 1813; Hydrodyn., 1814.
- Least Action, 1533.

- Least Squares, 1749, (Principle of) 1763, etc.
- Legendre, 70, 271, 274, 375, 382, 391, 530, 807, 852, 853, 897, 916, 919, 943, 1037, (ii) p. 216, 1099, 1117, 1120, (ii) p. 290, 1139, 1153, 1158, 1168, 1481, 1778.
- Legendre's Coefficients, 1798, etc., 1818, etc. (working formulae), 1853; Graphs, 1855, etc.; Various forms, 1801, etc., (Differential Coefficients of) 1841, (Properties) 1841, etc.
- Lemniscate, 592, 598, 645, 872.
- Leslie Ellis, (ii) p. 268, 1746.
- Leudesdorf, 480, 498, 1182, 1188.
- Lexell, (i) p. 104.
- Liagre, 1778.
- Libri, 1049.
- Limaçon, 594, 1255.
- Limiting forms as definite integrals, 319.
- Line Integral (Stokes), 467.
- Lines crossing a contour, 1709, etc.
- Lintearia, 603.
- Liouville, (i) p. 639, (ii) p. 150, 962, 968, 969, 986, 987, (ii) p. 179, (ii) p. 361, 1910.
- Lodge, A., 70.
- Loxodrome, 722, 730.
- MacCullagh, 584.
- Maclaurin, 369, 911, 931, 1300.
- Malet, (ii) p. 603.
- Mathews, (ii) p. 528, (ii) p. 965.
- Maxwell. *See* Clerk Maxwell.
- Mean Values, 1640, etc., (Combination of) 1642; Distribution, 1646; $M(\rho)$, 1650, etc.; $M(\rho^{-1})$, 1651; $M(\rho^n)$, 1657, $M(\rho^n)$, 1661; $M(A)$, $M(V)$, 1662; Miscellaneous, 1663; (Restricted) 1666; Geometric Mean (Maxwell), 1671-1678.
- Mechanical Integrators, 505, (i) p. 522.
- Mercator's Projection, (ii) p. 417.
- Meromorphic functions, 1245.
- Merriman, 1746, 1778.
- Miller, (ii) p. 291.
- Minchin, 604.
- Modular Equation, 1480.
- Modulus. Legendrian, 371, 1453, 1454, etc.
- Weierstraasian, 1380.
- Errors, 1748.
- Moigno, 352.
- Moment of Inertia, 455, 526, 771.
- Monge, 1553, 1555.
- Morley, (ii) p. 291.
- Motion of a rod, 473.
- Multiple Angles, 117.
- Murphy, (i) p. 169.
- Nanson, (ii) p. 360.
- Neil, 516.
- Neison, 1741.
- Newton, 4, 9, 10.
- Nome, 372.
- Norm, 1876.
- Normal Equations, 1764.
- Origins of pedals of given area, 444.
- Orthogonal Coordinates, 789.
- Oval, 440, 441, 445, 448.
- Ovoid, 627.
- $\wp(u)$ Expansion, 1416.
- Π function, 886, etc.
- Pappus, 752.
- Parallel Curves, 435.
- Parallel Rulings, 1704.
- Paranome, 372.
- Parker, (i) p. 64.
- Partial Fractions, 139, etc., 1891, etc.
- Pascal, 518.
- Peacock, (i) p. 319.
- Pedal Curves, 422, 424, 561, 563, 564.
- Pedal of Evolute, 425.
- Pedal of Minimum Area, 449.
- Peirce, 1778.
- Pendulum, 389.
- Periodicity. Elliptic function, 1297, etc., 1330, etc., 1335, 1352; $\wp(u)$, 1385.
- Hyperbolic function, 67.
- Period Parallelogram, 1298.
- Petzval, (i) p. 380.
- Plana, 929, 1183.
- Planimeter, 505.
- Poisson, 989, 990, 1068, 1108, 1139, (ii) p. 358, 1548, 1601, (ii) p. 741, 1778.
- Polar Subtangent, 437.
- Pole, 1244.
- Pole Clusters, 1317.
- Popoff, 366.
- Powers, etc., of sines and cosines, 114.
- Preston, 560, 1169, 1174, 1175, 1176.
- Principal Values, 344.
- Product of Inertia, 526.
- ψ function, 911, etc., 950, etc.
- Quadrature, 393, etc.; Line Integral 398; Sectorial Areas, 407; Tangential-Polars, 418; Trilinears, 460.
- Quasi-Inversion, 1255.

- Raabe, 1083.
 Random Points, 1688, etc.; Lines, 1707.
 Rankine, (i) p. 31.
 Rational fractional forms, 127, etc., 1891, etc.
 Reciprocal Quartic, 314.
 Rectification formulae, 511, etc., 739.
 Reduction formulae, 101, 185, 208, etc., 1057, 1144, 1148.
 Reduction to standard form: Legendrian, 1459, etc.; Weierstrassian 1449, etc.
 Relative Maxima and Minima, 1504, 1558, 1565, 1582.
 Review of cases of integration by means of elementary functions, 1905, etc.
 Regnault, (i) p. 64.
 Rhodoneae, 705.
 Rhumb line, 722, 730.
 Riemann: Surface, 1261; Definition, 1876, etc.; Theorem, 1878, etc.
 Roberts, 614, 615.
 Roberts, R. A., 623, 625, 642, 647, (i) p. 670, 710.
 Rodrigues, 1802, 1828.
 Rolling Curves, 655.
 Roulette, 678.
 Routh, 363, 504, 603, 604, (i) p. 637, 756, 771, 823, 877, (ii) p. 179, (ii) p. 525, 1651, 1652, 1653, 1661, 1663, (ii) p. 933.
 Russell, 305.
 Russell, W. H. L., (ii) p. 360, p. 361.
 Salmon, 583, 584, 743, 1904.
 Sanjána, (ii) p. 291, 1650.
 Schulz, 733.
 Schwarz, 1398, 1431.
 Secants, 120.
 Seidel, 1900.
 Semi-cubical Parabola, 516.
 Serret, 271, 334, 352, 601, (i) p. 638, 646, 647, 648, (i) p. 669, p. 670, 807, 897, 907, 922, 944, (ii) p. 149, 1159, 1164, 1168, 1201.
 Sheets, 1261.
 Short-range Variations, 1574.
 Sigma functions, Weierstrassian, 1381; Expansion, 1418.
 Simpson, 21.
 Singularities, 1243.
 Six connections, 217, 219, 225.
 Smaasen, (ii) p. 360.
 Smith, C., 460, 713, 789, 899, 911, 1696.
 Smith, H. J. S., 1876, 1878, 1880.
 Soldner, 1178, etc., 1906.
 Solid Angle, 821.
 Spence, 1906.
 Spherical areas, 780; curves, 728; triangle, 781; polar elements, 775-778.
 Spherical Harmonics, 1785, etc., 1789; Poles and Axes, 1790; Number of constants, 1788 and 1796; Surface Harmonics, 1787; Derivation of, 1791; General form, 1792; Zonal Harmonics, 1795; Sectorial Harmonics, 1865; Tesseral Harmonics, 1865; Differentiation of Zonal Harmonics, 1873.
 Sphero-Conic, 388, 735.
 Spitzer, (i) 379.
 Standard forms. Elementary, 44, 89. Legendrian, 371, 1329, etc., 1459, etc.
 Weierstrassian, 1380, etc., 1446, etc.
 Strict accuracy of, 1890.
 Standard Results, Gamma Function, 955.
 Stanham, (ii) p. 851.
 Stationary Curves, 1570, etc.
 Steiner, 672, 675.
 Stereographic Projection, 727, (ii) p. 417.
 Stirling, 875, 877, 884, 941.
 Stokes, 466, 467, (ii) p. 152, 1781, etc., 1900.
 Stolz, 1892 (application of Legendrian Substitution to form $1/X\sqrt{Y}$).
 Substitutions, 55.
 Surface (Element), 772, (curves on a), Calculus of Variations, 1511.
 Surface Integrals, 451, etc., 1781.
 Surface of Ellipsoid, 807, 809.
 Surface of Revolution, 748.
 Sylvester, (ii) p. 47, 1725.
 Synectic Functions, 1243.
 System of moving particles, 492.
 Table of standard forms, 44, 89.
 Table of values of S_p , 957.
 Tail, 433.
 Tait and Steele, (i) p. 377, (ii) p. 525.
 Tangents and Cotangents, 125.
 Taylor, 365; Theorem, 1300.
 Tchebechef, 1073.
 Tetrahedrals, 804.
 Theta functions (Jacobi), 1366, 1627.
 Thomson, Sir J. J., (ii) p. 523.

- Thomson and Tait, 1592, 1782, (Lord Kelvin's Extension of Green's Theorem), 1786.
- Todhunter, (i) p. 169, 353, (i) p. 377, (i) p. 378, 820, 852, (ii) p. 48, 897, (ii) p. 151, 972, 1185, (ii) p. 417, 1507, (ii) p. 657, (ii) p. 719, (ii) p. 741, (ii) p. 743, 1701, 1704, 1736, 1742, (ii) p. 852, 1746, 1749, 1805, (ii) pp. 934, 936.
- Todhunter and Leathem, 733, 781, 824.
- Townsend, 1540, (ii) p. 651.
- Transcendents (orders of), 1905.
- Trapezoidal Rule, 22.
- Trembley, 1701.
- Trilinears, 460, 633.
- Triplication, 1358.
- Trochoid, 596.
- True Anomaly, 1156.
- Twisted Curves, 706, etc., 805.
- Unicursal Curves, 634, 1903, etc.
- Urn Problem, 1701.
- Van Huraet, 516, 637.
- Van Orstand, 70.
- Variations, Calculus of, 1482; Symbol of, 1485; Symbol ω , 1491.
- Variation of Integral, 1495.
- Variation of Double Integral, 1550.
- Vectors, 1204, etc.
- Verdet, 560, 1169.
- Volume : Cartesian, 760; Cylindrical, 774; Spherical Polar, 775.
- of surface of revolution, 24, 745.
- Wallis, 516, 518, 875, 876.
- Watt, (i) p. 35, (i) p. 64.
- Webster, 1783.
- Weddle, 22.
- Weierstrass, 899, 1238, 1380, $\wp(v)$ 1381, etc.; Periods, 1414, 1449, etc.
- Weight (of obs.), 1748; Resultant Weight, 1753.
- Whewell, 536, 557.
- Whitworth, 1683, (ii) p. 851.
- Wiggins, (i) p. 321.
- Williamson, 352, 366, 480, 483, 484, 488, 495, 614, 615, 637, 733, 1183, 1692.
- Wolstenholme, (i) p. 169, (i) p. 321, (i) p. 472, 639, (i) p. 148, (ii) p. 152, (ii) p. 178, 992, 1028, 1031, (ii) p. 239, 1085, 1091, 1093, 1096, 1097, 1098, 1650, (ii) p. 852.
- Woolhouse, 483.
- Wren, 518.
- Zerr, (ii) p. 851.
- Zeta Function (Jacobi), 1366; (Weierstrass), 1381; Expansion, 1418.
- Zeuner, (i) p. 64.
- Zolotareff, 366.

IDEALTHEORIE

By **W. KRULL**

—(Ergeb. der Math.) 1935. 159 pp. $5\frac{1}{2} \times 8\frac{1}{2}$ Orig. publ. (paper bound) at \$7.00. [48] Cloth, \$3.95

GROUP THEORY

By **A. KUROSH**

Translated from the second Russian edition and with added notes by **PROF. K. A. HIRSCH**.

A complete rewriting of the first, and already famous, Russian edition.

Partial Contents: PART ONE: The Elements of Group Theory. Chap. I. Definition. II. Subgroups (Systems, Cyclic Groups, Ascending Sequences of Groups). III. Normal Subgroups. IV. Endomorphisms and Automorphisms. Groups with Operators. V. Series of Subgroups. Direct Products. Defining Relations, etc. PART TWO: Abelian Groups. VI. Foundations of the Theory of Abelian Groups (Finite Abelian Groups, Rings of Endomorphisms, Abelian Groups with Operators). VII. Primary and Mixed Abelian Groups. VIII. Torsion-Free Abelian Groups. Editor's Notes. Bibliography.

Vol. II. PART THREE: Group-Theoretical Constructions. IX. Free Products and Free Groups (Free Products with Amalgamated Subgroup, Fully Invariant Subgroups). X. Finitely Generated Groups. XI. Direct Products. Lattices (Modular, Complete Modular, etc.). XII. Extensions of Groups (of Abelian Groups, of Non-commutative Groups, Cohomology Groups). PART FOUR: Solvable and Nilpotent Groups. XIII. Finiteness Conditions, Sylow Subgroups, etc. XIV. Solvable Groups (Solvable and Generalized Solvable Groups, Local Theorems). XV. Nilpotent Groups (Generalized, Complete, Locally Nilpotent Torsion-Free, etc.). Editor's Notes. Bibliography.

—Vol I 2nd ed 1959 271 pp 6x9. [107] \$4.95

—Vol II. 2nd ed 1960 308 pp 6x9. [109] \$4.95

DIFFERENTIAL AND INTEGRAL CALCULUS

By **E. LANDAU**

Landau's sparkling *Einführung* in English translation. Completely rigorous, completely self-contained, borrowing not even the fundamental theorem of algebra (of which it gives a rigorous elementary proof), it develops the entire calculus including Fourier series, starting only with the properties of the number system. A masterpiece of rigor and clarity.

—2nd ed. 1960. 372 pp. 6x9 [78] \$6.00

ELEMENTARE ZAHLENTHEORIE

By **E. LANDAU**

"Interest is enlisted at once and sustained by the accuracy, skill, and enthusiasm with which Landau marshals . . . facts and simplifies . . . details."

—G. D. Birkhoff, *Bulletin of the A. M. S.*

VORLESUNGEN ÜBER ZAHLENTHEORIE

By E. LANDAU

The various sections of this important work (Additive, Analytic, Geometric, and Algebraic Number Theory) can be read independently of one another.

—Vol. I, Pt. 2. * (Additive Number Theory) xii + 180 pp. Vol. II. (Analytical Number Theory and Geometrical Number Theory) viii + 308 pp. Vol. III. (Algebraic Number Theory and Fermat's Last Theorem) viii + 341 pp. 5¼x8¼. * (Vol. I, Pt. 1 is issued as *Elementary Number Theory*.) Originally publ. at \$26.40

[32] Three vols. in one \$14.00

ELEMENTARY NUMBER THEORY

By E. LANDAU

The present work is a translation of Prof. Landau's famous *Elementare Zahlentheorie*, with added exercises by Prof. Paul T. Bateman.

PART ONE. Foundations of Number Theory. I. Divisors. II. Prime Numbers, Prime Factorization. III. G.C.D. IV. Number-theoretic Functions. V. Congruences. VI. Quadratic Residues. VII. Pell's Equation. PART TWO. Brun's Theorem and Dirichlet's Theorem. PART THREE. Decomposition into Two, Three, and Four Squares. I. Farey Fractions. II. Dec. into 2 Squares. III. Dec. into 4 Squares. IV. Dec. into 3 Squares. PART FOUR. Class Numbers of Binary Quadratic Forms. II. Classes of Forms. III. Finiteness of Class Number. IV. Primary Representation... VI. Gaussian Sums... IX. Final Formulas for Class Number.

EXERCISES for Parts One, Two, and Three.

—1958. 256 pp. 6x9.

[125] \$4.95

EINFÜHRUNG IN DIE ELEMENTARE UND ANALYTISCHE THEORIE DER ALGEBRAISCHE ZAHLEN UND DER IDEALE

By E. LANDAU

—2nd ed. vii + 147 pp. 5½x8

[62] \$2.95

GRUNDLAGEN DER ANALYSIS

By E. LANDAU

The student who wishes to study mathematical German will find Landau's famous *Grundlagen der Analysis* ideally suited to his needs.

Only a few score of German words will enable him to read the entire book with only an occasional glance at the Vocabulary! [A COMPLETE German-English vocabulary, prepared with the novice especially in mind, has been appended to the book.]

—3rd ed. 1960. 173 pp. 5¾x8.

[24] Cloth \$3.50
[141] Paper \$1.95

FOUNDATIONS OF ANALYSIS

By E. LANDAU

"Certainly no clearer treatment of the foundations of the number system can be offered. . . . One can only be thankful to the author for this fundamental piece of exposition, which is alive with his vitality and genius."—*J. F. Ritt, Amer. Math. Monthly.*

—2nd ed 1960. 6x9.

[79] \$3.50

HANDBUCH DER LEHRE VON DER VERTEILUNG DER PRIMZAHLEN

By E. LANDAU

To Landau's monumental work on prime-number theory there has been added, in this edition, two of Landau's papers and an up-to-date guide to the work: an Appendix by Prof. Paul T. Bateman.

—2nd ed 1953. 1,028 pp $5\frac{1}{2} \times 8\frac{1}{2}$ [96] Two vol set \$14.95

UEBER ANALYSIS

By E. LANDAU, B. RIEMANN, and H. WEYL

—See Weyl-Landau-Riemann

MEMOIRES SUR LA THEORIE DES SYSTEMES DES EQUATIONS DIFFERENTIELLES

LINEAIRES, Vols. I, II, III

By J. A. LAPPO-DANILEVSKIĪ

THREE VOLUMES IN ONE.

Some of the chapter titles are: General theory of functions of matrices; Analytic theory of matrices; Problem of Poincaré; Systems of equations in neighborhood of a pole; Analytic continuation; Integral equations and their application to the theory of linear differential equations; Riemann's problem; etc.

"The theory of [systems of linear differential equations] is treated with elegance and generality by the author, and his contributions constitute an important addition to the field of differential equations."—*Applied Mechanics Reviews.*

—3 volumes bound as one. 689 pp $5\frac{1}{4} \times 8\frac{1}{4}$ [94] \$10.00

TOPOLOGY

By S. LEFSCHETZ

CONTENTS: I. Elementary Combinatorial Theory of Complexes. II. Topological Invariance of Homology Characters. III. Manifolds and their Duality Theorems. IV. Intersections of Chains on a Manifold. V. Product Complexes. VI. Transformations of Manifolds, their Coincidences, Fixed Points. VII. Infinite Complexes. VIII. Applications to Analytical and Algebraic Varieties.

—2nd ed. (Corr. repr. of 1st ed.). x + 410 pp. $5\frac{1}{4} \times 8\frac{1}{4}$.

[116] \$4.95

ELEMENTS OF ALGEBRA

By HOWARD LEVI

"This book is addressed to beginning students of mathematics. . . . The level of the book, however, is so unusually high, mathematically as well as pedagogically, that it merits the attention of professional mathematicians (as well as of professional pedagogues) interested in the wider dissemination of their subject among cultured people . . . a closer approximation to the right way to teach mathematics to beginners than anything else now in existence."—*Bulletin of the A. M. S.*

—Third ed. 1960 xi + 161 pp. 5 $\frac{3}{4}$ ×8 [103] \$3.25

LE CALCUL DES RÉSIDUS

By E. LINDELÖF

Important applications in a striking diversity of mathematical fields: statistics, number theory, the theory of Fourier series, the calculus of finite differences, mathematical physics and advanced calculus, as well as function theory itself.

—151 pp. 5 $\frac{1}{2}$ ×8 $\frac{1}{2}$ [134] \$3.25

THE THEORY OF MATRICES

By C. C. MacDUFFEE

"No mathematical library can afford to be without this book."—*Bulletin of the A. M. S.*

—(Ergeb. der Math.) 2nd edition 116 pp. 6×9 Orig. publ. at \$5.20 [281] \$2.95

MACMAHON, "Introduction . . ." see Klein

COMBINATORY ANALYSIS, Vols. I and II

By P. A. MACMAHON

TWO VOLUMES IN ONE.

A broad and extensive treatise on an important branch of mathematics.

—xx + 300 + xx + 340 pp. 5 $\frac{3}{8}$ ×8 [137] Two vols. in one \$7.50

FORMULAS AND THEOREMS FOR THE FUNCTIONS OF MATHEMATICAL PHYSICS

By W. MAGNUS and F. OBERHETTINGER

Gathered into a compact, handy and well-arranged reference work are thousands of results on the many important functions needed by the physicist, engineer and applied mathematician.

Translated by J. WERMER.

—1954 182 pp. 6×9. German edition was \$7.00 [51] \$3.90

CHELSEA SCIENTIFIC BOOKS

THE DEVELOPMENT OF MATHEMATICS IN CHINA AND JAPAN

By *Y. MIKAMI*

A scholarly work.

—First ed 1913 viii + 347 pp 5 $\frac{3}{8}$ ×8 Summer, '61
[149] Prob \$3.95

GEOMETRIE DER ZAHLEN

By *H. MINKOWSKI*

—viii + 256 pp 5 $\frac{1}{2}$ ×8 $\frac{1}{4}$ [93] \$4.50

DIOPHANTISCHE APPROXIMATIONEN

By *H. MINKOWSKI*

"Since the author has given an elementary, entertaining, account, both in geometric and arithmetic language, of some important original results as well as the salient features of a classic theory, but presented in a novel manner, his work is deserving of the attention of the very widest circle of readers."—*L. E. Dickson*.

—viii + 235 pp. 5 $\frac{1}{4}$ ×8 $\frac{1}{4}$ [118] \$4.50

MORDELL, "Fermat's Last Theorem," see *Klein*

INVERSIVE GEOMETRY

By *F. MORLEY and F. V. MORLEY*

CHAPTER HEADINGS: I. Operations of Elementary Geometry. II. Algebra. III. The Euclidean Group. IV. Inversions. V. Quadratics. VI. The Inversive Group of the Plane. VII. Finite Inversive Groups. VIII. Parabolic, Hyperbolic, and Elliptic Geometries. IX. Celestial Sphere. X. Flow. XI. Differential Geometry. XII. The Line and the Circle. XIII. Regular Polygons. XIV. Motions. XV. The Triangle. XVI. Invariants under Homologies. XVII. Rational Curves. XVIII. Conics. XIX. Cardioid and Deltoid. XX. Cremona Transformations. XXI. The n -Line.

—xi + 273 pp 5 $\frac{1}{4}$ ×8 $\frac{1}{4}$ [101] \$3.95

LEHRBUCH DER KOMBINATORIK

By *E. NETTO*

The standard work on the fascinating subject of Combinatory Analysis.

—Second edition viii + 348 pp 5×8 in. [123] \$4.95

VORLESUNGEN ÜBER DIFFERENZENRECHNUNG

By *N. H. NÖRLUND*

—ix + 551 pp. 5×8. Orig. publ. at \$11.50. [100] \$5.95

**FUNCTIONS OF REAL VARIABLES
FUNCTIONS OF A COMPLEX VARIABLE**

By **W. F. OSGOOD**

TWO VOLUMES IN ONE.

"Well-organized courses, systematic, lucid, fundamental, with many brief sets of appropriate exercises, and occasional suggestions for more extensive reading. The technical terms have been kept to a minimum, and have been clearly explained. The aim has been to develop the student's power and to furnish him with a substantial body of classic theorems, whose proofs illustrate the methods and whose results provide equipment for further progress."—*Bulletin of A. M. S.*

—676 pp. 5x8. 2 vols. in 1.

[124] \$4.95

DIE LEHRE VON DEN KETTENBRUECHEN

By **O. PERRON**

Both the Arithmetic Theory and the Analytic Theory are treated fully.

"An indispensable work . . . Perron remains the best guide for the novice. The style is simple and precise and presents no difficulties."

—*Mathematical Gazette.*

—2nd ed. 536 pp. 5¼x8

[73] \$5.95

IRRATIONALZAHLEN

By **O. PERRON**

Methods of introducing irrational numbers (Cauchy, Bolzano, Weierstrass, Dedekind, Cantor, Méray, Bachman, etc.) *Systematic fractions, continued fractions, Cantor's series and algorithm, Lüroth's and Engel's series, Cantor's products. Approximations, Kronecker theorem, Algebraic and transcendental numbers (including transcendence proofs for e and π ; Liouville numbers, etc.)*

—2nd ed. 1939 207 pp. 5¼x8¼

[47] Cloth \$3.25

[113] Paper \$1.50

**EIGHT-PLACE TABLES OF
TRIGONOMETRIC FUNCTIONS**

By **J. PETERS**

With an appendix on the computation to twenty decimal places.

—Approx. 950 pp. 8x11.

[154] In prep.

SUBHARMONIC FUNCTIONS

By **T. RADO**

—(*Ergeb. der Math.*) 1937. iv + 56 pp. 5½x8½. [60] \$2.00

CHELSEA SCIENTIFIC BOOKS

THE PROBLEM OF PLATEAU

By T. RADO

—(Ergeb. der Math.) 1933. 113 pp. $5\frac{1}{2}\times 8$. Orig. publ. (in paper binding) at \$5.10. [81] Cloth, \$2.95

EINFÜHRUNG IN DIE KOMBINATORISCHE TOPOLOGIE

By K. REIDEMEISTER

Group Theory occupies the first half of the book; applications to Topology, the second. This well-known book is of interest both to algebraists and topologists.

—221 pp. $5\frac{1}{2}\times 8\frac{1}{4}$ [76] \$3.50

KNOTENTHEORIE

By K. REIDEMEISTER

—(Ergeb. der Math.) 1932. 78 pp. $5\frac{1}{2}\times 8\frac{1}{2}$. [40] \$2.25

FOURIER SERIES

By W. ROGOSINSKI

Translated by H. COHN. Designed for beginners with no more background than a year of calculus, this text covers, nevertheless, an amazing amount of ground. It is suitable for self-study courses as well as classroom use.

“The field covered is extensive and the treatment is thoroughly modern in outlook . . . An admirable guide to the theory.”—*Mathematical Gazette*.

—Second ed. 1959. vi + 176 pp. $4\frac{1}{2}\times 6\frac{1}{2}$. [67] \$2.25

CONIC SECTIONS

By G. SALMON

“The classic book on the subject, covering the whole ground and full of touches of genius.”

—*Mathematical Association*.

—6th ed. xv + 400 pp. $5\frac{1}{4}\times 8\frac{1}{4}$. [99] Cloth \$3.25
[98] Paper \$1.94

HIGHER PLANE CURVES

By G. SALMON

CHAPTER HEADINGS: I. Coordinates. II. General Properties of Algebraic Curves. III. Envelopes. IV. Metrical Properties. V. Cubics. VI. Quartics. VII. Transcendental Curves. VIII. Transformation of Curves. IX. General Theory of Curves.

—3rd ed. xix + 395 pp. $5\frac{3}{8}\times 8$. [138] \$4.95

ANALYTIC GEOMETRY OF THREE DIMENSIONS

By G. SALMON

A rich and detailed treatment by the author of *Conic Sections*, *Higher Plane Curves*, etc.

—Seventh edition (V. 1). 496 pp. 5x8 [122] \$4.95

INTRODUCTION TO MODERN ALGEBRA AND MATRIX THEORY

By O. SCHREIER and E. SPERNER

An English translation of the revolutionary work, *Einführung in die Analytische Geometrie und Algebra*. Chapter Headings: I. Affine Space. Linear Equations. (Vector Spaces). II. Euclidean Space. Theory of Determinants. III. The Theory of Fields. Fundamental Theorem of Algebra. IV. Elements of Group Theory. V. Matrices and Linear Transformations. The treatment of matrices is especially extensive.

"Outstanding . . . good introduction . . . well suited for use as a text . . . Self-contained and each topic is painstakingly developed."

—*Mathematics Teacher*.

—Second ed. 1959. viii + 378 pp. [80] \$6.00

PROJECTIVE GEOMETRY OF n DIMENSIONS

By O. SCHREIER and E. SPERNER

Translated from the German by CALVIN A. ROGERS.

A textbook on the analytic projective geometry of n dimensions whose clarity and explicitness of presentation can hardly be surpassed.

Suitable for a one-semester course on the senior undergraduate or first-year graduate level. The background required is minimal: The definition and simplest properties of vector spaces and the elements of matrix theory. For the reader lacking this background, suitable reference is made to the Authors' companion volume *Introduction to Modern Algebra and Matrix Theory*.

There are exercises at the end of each chapter to enable the student to test his mastery of the material.

CHAPTER HEADINGS: I. n -Dimensional Projective Space. II. General Projective Coordinates. III. Hyperplane Coordinates. The Duality Principle. IV. The Cross Ratio. V. Projectivities. VI. Linear Projectivities of P_n onto Itself. VII. Correlations. VIII. Hypersurfaces of the Second Order. IX. Projective Classification of Hypersurfaces of the Second Order. X. Projective Properties of Hypersurfaces of the Second Order. XI. The Affine Classification of Hypersurfaces of the Second Order. XII. The Metric Classification of Hypersurfaces of the Second Order.

—1961. 208 pp. 6x9.

[126] \$4.95

**PROJECTIVE METHODS
IN PLANE ANALYTICAL GEOMETRY**

By C. A. SCOTT

The original title of the present work, as it appeared in the first and second editions, was "An Introductory Account of Certain Modern Ideas and Methods in Plane Analytic Geometry." The title has been changed to the present more concise and more descriptive form, and the corrections indicated in the second edition have been incorporated into the text.

CHAPTER HEADINGS: I. Point and Line Coordinates. II. Infinity. Transformation of Coordinates. III. Figures Determined by Four Elements. IV. The Principle of Duality. V. Descriptive Properties of Curves. VI. Metric Properties of Curves; Line at Infinity. VII. Metric Properties of Curves; Circular Points. VIII. Unicursal (Rational) Curves. Tracing of Curves. IX. Cross-Ratio, Homography, and Involution. X. Projection and Linear Transformation. XI. Theory of Correspondence. XII. The Absolute. XIII. Invariants and Covariants.

—Ready, Summer, 1961. 3rd ed xiv + 288 pp. 5x8.
[146] Probably \$3.50

LEHRBUCH DER TOPOLOGIE

By H. SEIFERT and W. THRELFALL

This famous book is the only modern work on *combinatorial topology* addressed to the student as well as to the specialist. It is almost indispensable to the mathematician who wishes to gain a knowledge of this important field.

"The exposition proceeds by easy stages with examples and illustrations at every turn."

—*Bulletin of the A. M. S.*

—1934 360 pp 5½x8½. Orig. publ. at \$8.00. [31] \$4.95

SHEPPARD, "From Determinant to Tensor," see Klein

HYPOTHÈSE DU CONTINU

By W. SIERPIŃSKI

An appendix consisting of sixteen research papers now brings this important work up to date. This represents an increase of more than forty percent in the number of pages.

"One sees how deeply this postulate cuts through all phases of the foundations of mathematics, how intimately many fundamental questions of analysis and geometry are connected with it . . . a most excellent addition to our mathematical literature."

—*Bulletin of A. M. S.*

—Second edition. 1957. xvii + 274 pp. 5x8. [117] \$4.95

SINGH, "Non-Differentiable Functions," see Hobson

DIOPHANTISCHE GLEICHUNGEN

By T. SKOLEM

"This comprehensive presentation . . . should be warmly welcomed. We recommend the book most heartily."—*Acta Szeged*.

—(Ergeb. der Math.) 1938. ix + 130 pp. $5\frac{1}{2} \times 8\frac{1}{2}$. Cloth. Orig. publ. at \$6.50. [75] \$3.50

ALGEBRAISCHE THEORIE DER KOERPER

By E. STEINITZ

"Epoch-making."—*A. Haar, Acta Szeged*.

—177 pp. including two appendices. $5\frac{1}{4} \times 8\frac{1}{4}$. [77] \$3.25

INTERPOLATION

By J. F. STEFFENSEN

"A landmark in the history of the subject.

"Starting from scratch, the author deals with formulae of interpolation, construction of tables, inverse interpolation, summation of formulae, the symbolic calculus, interpolation with several variables, in a clear, elegant and rigorous manner . . . The student . . . will be rewarded by a comprehensive view of the whole field. . . . A classic account which no serious student can afford to neglect."—*Mathematical Gazette*.

—1950. 2nd ed. 256 pp. $5\frac{1}{4} \times 8\frac{1}{4}$. Orig. \$8 00 [71] \$4.95

A HISTORY OF THE MATHEMATICAL THEORY OF PROBABILITY

By I. TODHUNTER

Introduces the reader to *almost every process and every species of problem which the literature of the subject can furnish*. Hundreds of problems are solved in detail.

—640 pp. $5\frac{1}{4} \times 8$. Previously publ. at \$8.00. [57] \$6.00

SET TOPOLOGY

By R. VAIDYANATHASWAMY

In this text on Topology, the first edition of which was published in India, the concept of partial order has been made the unifying theme.

Over 500 exercises for the reader enrich the text.

CHAPTER HEADINGS: I. Algebra of Subsets of a Set. II. Rings and Fields of Sets. III. Algebra of Partial Order. IV. The Closure Function. V. Neighborhood Topology. VI. Open and Closed Sets. VII. Topological Maps. VIII. The Derived Set in T_1 Space. IX. The Topological Product. X. Convergence in Metrical Space. XI. Convergence Topology.

—2nd ed. 1960. vi + 305 pp. 6x9.

[139] \$6.00

LECTURES ON THE GENERAL THEORY OF
INTEGRAL FUNCTIONS

By G. VALIRON

—1923. xii + 208 pp. 5¼x8.

[56] \$3.50

GRUPPEN VON LINEAREN
TRANSFORMATIONEN

By B. L. VAN DER WAERDEN

—(Ergeb. der Math.) 1935. 94 pp. 5½x8½.

[45] \$2.50

LEHRBUCH DER ALGEBRA

By H. WEBER

The bible of classical algebra, still unsurpassed for its clarity and completeness. Much of the material on elliptic functions is not available elsewhere in connected form.

PARTIAL CONTENTS: VOL. I. CHAP. I. Rational Functions. II. Determinants. III. Roots of Algebraic Equations. V. Symmetric Functions. V. Linear Transformations. Invariants. VI. Tschirnhaus Transformation. VII. Reality of Roots. VIII. Sturm's Theorem. X. Limits on Roots. X. Approximate Computation of Roots. XI. Continued Fractions. XII. Roots of Unity. XIII. Galois Theory. XIV. Applications of Permutation Group to Equations. XV. Cyclic Equations. XVI. Kreisteilung. XVII. Algebraic Solution of Equations. XVIII. Roots of Metacyclic Equations.

VOL. II. CHAPS. I.-V. Group Theory. VI.-X. Theory of Linear Groups. XI.-XVI. Applications of Group Theory (General Equation of Fifth Degree. The Group G_{216} and Equations of Seventh Degree . . .). XVII.-XXIV. Algebraic Numbers. XXV. Transcendental Numbers.

VOL. III. CHAP. I. Elliptic Integral. II. Theta Functions. III. Transformation of Theta Functions. IV. Elliptic Functions. V. Modular Function. V. Multiplication of Elliptic Functions. Division. VII. Equations of Transformation. VIII. Groups of the Transformation Equations and the Equation of Fifth Degree . . . XI.-XVI. Quadratic Fields. XVII. Elliptic Functions and Quadratic Forms. XVIII. Galois Group of Class Equation. XIX. Computation of Class Invariant . . . XII. Cayley's Development of Modular Function. XXIII. Class Fields. XXIV.-XXVI. Algebraic Functions. XXVII. Algebraic and Abelian Differentials.

—Ready, Fall, '61. 3rd ed. (C. repr. of 2nd ed.). 2,345 pp. 5x8.
[144] Three vol. set. Probably \$19.50

**DAS KONTINUUM,
und andere Monographien**

By *H. WEYL, E. LANDAU, and B. RIEMANN*

FOUR VOLUMES IN ONE.

DAS KONTINUUM (Kritische Untersuchungen ueber die Grundlagen der Analysis), by *H. Weyl*. Reprint of 2nd edition.

MATHEMATISCHE ANALYSE DES RAUMPROBLEMS, by *H. Weyl*.

DARSTELLUNG UND BEGRUENDUNG EINIGER NEUERER ERGEBNISSE DER FUNKTIONENTHEORIE, by *E. Landau*. Reprint of 2nd edition.

UEBER DIE HYPOTHESEN, WELCHE DER GEOMETRIE ZU GRUNDE LIEGEN, by *B. Riemann*. Reprint of 3rd edition, edited and with comments by *H. Weyl*.

—83 + 117 + 120 + 48 pp. 5¼x8. [134] Four vols. in one. **\$6.00**

THE THEORY OF GROUPS

By *H. J. ZASSENHAUS*

In this considerably augmented second edition of his famous work, Prof. Zassenhaus puts the original text in a lattice-theoretical framework. This has been done by the addition of new material as appendixes, so that the book can also continue to be read as before, on a strictly group-theoretical level. The new edition has sixty percent more pages than the old.

The number of exercises, also has been greatly increased.

"A wealth of material in compact form."

—*Bulletin of A. M. S.*

—Second edition. 1958. viii + 265 pp. 6x9. [53] **\$6.00**

